



PRONAUTIC
MARINE EQUIPMENT

RECAMBIOS para MOTORES **INTRABORDA** 2023

MERCUISER - VOLVO - OMC - YANMAR



CONDICIONES DE LA GARANTIA SIERRA PARA CLIENTES PROFESIONALES

Todos los productos Sierra están garantizados en caso de piezas defectuosas, dicha garantía se regirá por las siguientes condiciones.

Todos los componentes **Sierra** que originalmente hayan sido instalados por un mecánico profesional y estén defectuosas, la pieza será abonada así como los gastos asociados que haya podido generar el cambio de dicha pieza.

La mano de obra se calculará basándose en los tiempos de recambio establecidos y fijados para cada componente.

Para tramitar la garantía el primer paso es devolver el recambio defectuoso indicando la referencia, la fecha de compra y el fallo detectado. Una vez sea recibido por Pronautic nosotros lo enviaremos a Sierra.

En el caso que hayan gastos asociados, mano de obra etc.. se deberán detallar en el momento de la devolución del material físicamente. Es imprescindible reclamar todo los gastos en el momento de la devolución física del material.

En dicho escrito deberá detallarse:

- 1- Todos los componentes utilizados para la reparación en garantía.
- 2- Las horas de mano de obra detalladas. Detallar las horas manos de obra en los recambios reemplazados.
- 3- Año, modelo y número de serie del motor.
- 4- Nombre y dirección del distribuidor donde se adquirió la pieza.
- 5- Nombre y dirección del cliente final.
- 6- Cualquier otra información adicional.

Excepciones de la garantía:

En los siguientes casos la garantía quedaría invalidada:

- a- Instalación y uso incorrecto. Cuando se instalen productos en una aplicación no detallada en nuestro catálogo.
- b- Artículos modificados.
- c- Incorrecto mantenimiento.

Para más información contacte con el departamento de recambios.

recambios@pronautic.net

ÍNDICE ALFABÉTICO

GUÍA RÁPIDA POR MARCAS DE MOTOR/COMPETENCIAS COMPONENTES VARIOS MARCAS DE MOTORES INTRABORDA

MERCUISER (Pág.28 a 201)	
Cruce de referencias original Mercruiser/Pronautic	384-385
Hélices Mercruiser	200
Cruce de referencias hélices Mercruiser original/Pronautic	200
Bujías	198-199
OMC (Pág.202 a 277)	
Cruce de referencias original OMC/Pronautic	400 a 406
Hélices OMC	277
Cruce de referencias hélices OMC original/Pronautic	277
Bujías	276
VOLVO (Pág.278 a 349)	
Cruce de referencias original Volvo/Pronautic	408 a 410
Hélices Volvo	349
Cruce de referencias hélices Volvo original/Pronautic	349
Bujías	346 a 348
Turbos	348
YANMAR (Pág.351 a 361)	
Cruce de referencias original Yanmar/Pronautic	413-414
Turbos	360-361
COMPONENTES INTERNOS DE MOTOR	
Componentes internos de motor	367-387

COMPETENCIAS

GLM Cruce de referencias GLM/Pronautic	383
----------------------------------------	------------

VARIOS

Aceites y Lubricantes	13 a 20
-----------------------	----------------

Bloques de motor manufacturados	21 a 25
---------------------------------	----------------

Herramientas	26-27
--------------	--------------

Equipos de diagnosis	10
-----------------------------	-----------

MERCUISER (Pág.28 a 201)**Combustible Mercruiser (Pág.61 a 81)**

Anti-deflagrante	74
------------------	-----------

Bomba combustible eléctrica	74-45
-----------------------------	--------------

Bombas mecánicas de combustible	74-75
---------------------------------	--------------

Carburadores kits y otros	69-70
---------------------------	--------------

Carburadores	65-66
--------------	--------------

Filtros de combustible	79 a 81
------------------------	----------------

Inyección combustible/componentes	62-63
-----------------------------------	--------------

Línea combustible	69
-------------------	-----------

Separadores agua/combustible y soporte	78 a 80
----------------------------------------	----------------

Componentes internos Mercruiser (Pág.129 a 149)

Carters	129
---------	------------

Cojinetes	133
-----------	------------

Culatas	129
---------	------------

Filtros de aceite	129
-------------------	------------

Juntas de culata	143
------------------	------------

Juntas/kits	138 a 148
-------------	------------------

Levas hidráulicas	130
-------------------	------------

Pistones/aros	130
---------------	------------

Retenes tapa distribución	137
---------------------------	------------

Retenes válvula	137
-----------------	------------

Electricidad Mercruiser (Pág.50 a 60)

Alternadores	57-58
Motores de arranque	50 a 53
Reguladores de voltaje	58
Solenoides	54-55
Trim/Tilt motores/bombas	55-56
Encendido Mercruiser (Pág.30 a 50)	
Bobinas	33-34
Bujías	198-199
Bujías cables/kits	50
Contactos/kits	31
Conversión kits	35
Distribuidor tapa	32-33
Distribuidores	36 a 39
Encendido kits	30-31
Encendido modulos	34
Rotores	32
Refrigeración Mercruiser (Pág.82 a 128)	
Alojamiento termostato	89
Bombas circulación de agua	82
Bombas de agua kits	84-85
Correas	99 y 103
Despieces	86-87 y 104 a 117
Impulsores/kits	82 a 84
Manguitos	95 a 98
Termostatos/kits	88-89
Tabla identificación modelo Mercruiser (Pág.28-29)	
Transmisión Mercruiser (Pág.149 a 196)	
Ánodos	188-189
Aros	194 a 196
Cable de cambio/kits	172-173
Cardan	167
Cilindros/kits-Power trim	186
Cojinetes/kits	167 y 178 a 180
Colas parte inferior	162-163

Colas unidad superior	162-163
Crucetas cardan	167
Despieces	152 a 161
Eje transmisión	176-177
Engranajes/kits	164 a 166 y 175-176
Fuelles	171
Gruesos/kits	162
Hélices	200
Latiguillos Power Trim	183-184
Retenes de aceite	193-194
Tapas escape	192
Transom retenes/kits	170
Tuercas hélices/kits	182-183
OMC (Pág.202 a 277)	
Combustible OMC (Pág.219 a 227)	
Anti-deflgrante	223
Bombas de combustible	223-224
Carburadores	219
Kits de carburador y otros	220-221
Componentes inyección de combustible	218
Filtros de combustible	224 a 227
Linea de combustibe	223
Separadores/soportes de agua/combustible	225
Componentes internos OMC (Pág.242 a 251)	
Cojinetes	244
Culatas	243
Filtros de aceite	242
Juntas de culata	247
Juntas/juegos	245 a 251
Levas hidráulicas	243
Pistones/aros	243
Retenes	244
Electricidad OMC (Pág.213 a 218)	
Alternadores/Kits de reconstrucción	217

Motores de arranque	213-214
Motores tilt/trim	217-218
Reles	217
Solenoides	215
Encendido OMC (Pág.202 a 213)	
Bobinas	205
Bujías	276
Cables y kits para bujías	211
Condensadores	203
Distribuidores	207 a 209
Kits de conversión	206-207
kits de encendido	202 a 204
Rotores	203-204
Tapas de distribuidor	204
Refrigeración OMC (Pág.228 a 241)	
Alojamientos bombas de agua/kits	231
Bombas de circulación de agua	227
Colectores y accesorios	237 a 239
Correas	233
Despieces	234 a 236
Impulsores/kits	228 a 231
Manguitos	232
Sensores/transmisores de temperatura presión	231
Termostatos/kits	231-232
Transmisión OMC (Pág.252 a 277)	
Alojamiento cojinetes	264
Anodos	266-267
Arandelas	254,261 y 265
Aros tóricos	273 a 275
Bloqueadores pistones cola	265
Cardan	255
Cojinetes	260,264
Despieces	252-253
Ejes hélice	262
Ejes transmisión	261-262

Engranajes/kits	262
Fuelles/kits	259
Hélices	277
Piñones embrague	262
Retenes de aceite	271-272
Retenes transom	259
Retenes/kits	266, 268 a 270
Tuercas hélices/kits	265
VOLVO (Pág.278 a 349)	
Encendido Volvo (Pág.281 a 293)	
Bobinas	283
Bujías	346 a 348
Cables/kits para bujías	287
Condensadores	281
Distribuidores	284-285
Juegos de platinos	281
Kits de conversión	284-285
Kits de encendido	281
Rotores	281-282
Tapa distribuidor	282-283
Combustible Volvo (Pág.298-305)	
Bombas de combustible	301
Carburadores/kits	298-299
Filtros de combustible	303-304
Línea de combustible	300
Separadores agua/combustible y soportes	302
Componentes internos Volvo (Pág.321 a 332)	
Árbol de levas	321
Aros	324
Cojinetes	325
Correas	321
Culatas	323
Filtros de aceite	322,323 y 345
Filtros de aire	322

Juntas de culata	326 a 328
Juntas/juegos	326 a 332
Levas hidráulicas	324
Pistones	324
Retenes	325
Turbos	348
Válvulas	321
Electricidad Volvo (Pág.293 a 298 y 341 a 345)	
Alternadores	294-295 y 341
Diesel filtro aceite	345
Diesel filtro combustible	344
Motores de arranque	293-294 y 341
Motores trim/tilt	297-298
Reles	297
Solenoides	296-297
Guía de aplicación Volvo (Pág. 278 a 280)	
Refrigeración Volvo (Pág.305 a 320)	
Juego de juntas	316 a 318
Alojamiento termostatos	318
Bombas de agua	306
Colectores/codos y otros	312 a 314
Correas	309
Despieces	310-311
Impulsores/kits	307-308
Manguitos	306,309 y 318
Termostatos/kits	318-319
Transmisión Volvo (Pág. 332 a 349)	
Ánodos	336 a 339
Aros tóricos	340
Bloqueador de colas	333
Cardan	334
Cojinetes cardan	334
Dampers	332
Fuelles/kits	333 y 339

Hélices	349
Latiguillos	332
Retenes de aceite	340
Retenes/kits	333 y 339-340
Tuercas hélices/kits	335
YANMAR (Pág.351 a 361)	
Alternador	352
Anodos	358
Juntas	358
Impulsores	357-358
Motor de arranque	352-353
Filtros Aceite y Gasoil	351 y 359
Filtros de aire	357
Turbos	361



HERRAMIENTA DE DIAGNOSIS PARA MOTORES MARINOS Y ESTACIONARIOS (GENERADORES)

- Cobertura multimarca y multisistema en motores intraborda, motores fueraborda y motos de agua
- Diagnóstico completo con descripción detallada de los códigos de error
- Funciones de diagnóstico avanzadas: Calibraciones, Parametrizaciones y Memorización de llaves para motos de agua
- Detección automática de sistemas (Motor, Control de timón, Control de colas, Tren de propulsión, Frenos y marcha atrás, Instrumentación...)
- Información técnica integrada y esquemas eléctricos
- Datos de mantenimiento y de servicio
- Programa de actualizaciones definido
- Integración rápida de las novedades del mercado en nuestro software
- Interfaz de software rápida, intuitiva y fácil de usar
- Call-center para soporte técnico y de producto
- Formación
- GRP-Gestión de taller

RESUMEN DE PRODUCTOS:

	TIPO			
BARCO				
COMPLETO				
INTRABORDA				
FUERABORDA				
MOTO AGUA				

Cobertura

Intraborda:

CATERPILLAR
 CRUSADER
 CUMMINS
 CUMMINS MerCruiser Diesel
 ILMOR
 INDMAR
 IVECO-FPT
 JOHN DEERE
 MAN
 MERCURY MerCruiser
 MERCURY Racing
 MTU
 PCM
 SCANIA
 SCARAB
 SEA-DOO (BRP)
 STEYR
 VM MOTORI
 VOLKSWAGEN
 VOLVO PENTA
 WEBER
 YANMAR

Fueraborda:

EVINRUDE
 HONDA
 JOHNSON
 MARINER
 MERCURY
 MERCURY Racing
 NISSAN
 SELVA
 SUZUKI
 TOHATSU
 YAMAHA

Motos:

HSR-BENELLI
 KAWASAKI
 SEA-DOO (BRP)
 YAMAHA

Motores estacionarios:

CATERPILLAR
 CUMMINS
 DETROIT DIESEL-MBE
 DEUTZ
 DOOSAN
 HINO
 ISUZU
 IVECO-FPT
 JCB
 JOHN DEERE
 KOHLER
 KUBOTA
 LIEBHERR
 MAN
 MERCEDES-BENZ
 MTU
 PERKINS
 SCANIA
 SISU
 STEYR
 VM MOTORI
 VOLVO PENTA
 YANMAR

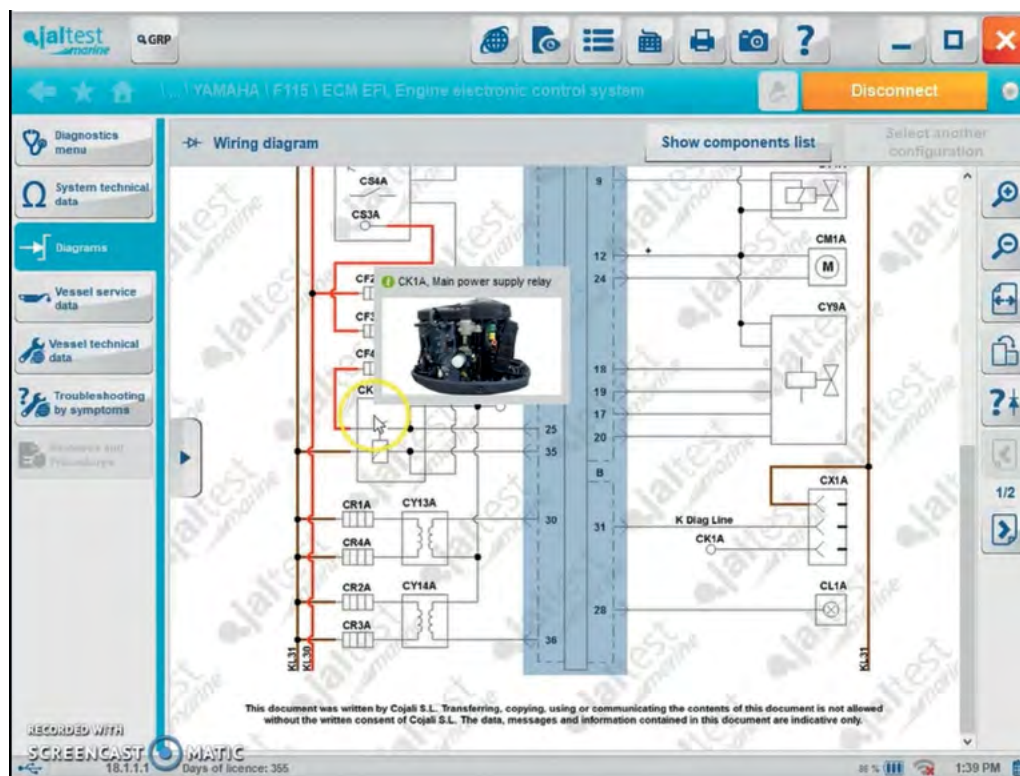

EN EL MERCADO DE LA DIAGNOSIS MARINA desde 2002

Solicita una visita con demo incluida.



Primers Spray

Fondo antioxidante de bajísima nocividad, alta resistencia a los arañazos, óptima adhesividad. Rociando sobre las superficies uniforma la sucesiva pintura, aumentando la resistencia. Metalzinc producto que permite efectuar sin ninguna herramienta especial un verdadero proceso de cincado en frío garantizando un perfecto revestimiento protector de la superficie tratada, con posibilidad de sobreponer esmalte y pinturas. Envases de 400ml.

Referencia	Aplicación	Color
101239	Anti-rust	Gris.
101240	Metal-zinc	Gris.
101251	Fosfozinc	verde



Antifoulings

Barniz antiincrustante para la protección de los pies de popa, de las hélices y colas en un cómodo envase spray. No contiene compuestos de estaño y cobre pero desarrolla su acción liberando venenos orgánicos no contaminantes. Antiincrustante de matriz dura adecuada para la velocidad media y alta. Envases de 400ml.

- 101205 Transparente
- 101206 Blanco
- 101207 Negro
- 101208 Gris

Pinturas para Colas y Motores Fueraborda

Barniz spray de rápida desecación. Fuerte resistencia a los agentes atmosféricos. Disponible en varios colores y envases de 400ml.



Referencia	Aplicación	Color	Referencia	Aplicación	Color
101209		● Transparente	101230	Volvo	● Rojo
101210	Evinrude	● Plata 84	101231	OMC	● Azul Colas
101211	Yanmar	● Gris	101232	Yamaha	● Azul Metalizado 74-85
101212	Caterpillar	● Amarillo	101233	Yamaha	● Gris Metalizado 94
101213	Vetus	● Amarillo	101234	Honda	● Gris Metalizado
101214	Onan	● Marfil	101235	Mariner	● Gris Claro
101215	Nanni	● Azul Metalizado	101236	Tohatsu	● Gris
101218	Aifo int	● Azul	101237	Tohatsu	● Azul Cobalto
101219	B.M.W	● Plata	101238	-	● Negro Mate
101220	Depósito	● Rojo	101249	Solè	● Azul
101221	Evinrude	● Azul 69-82	101250	Jonhson	● Blanco 81-83
101222	GM Alpine	● Verde	101252	Mercury	● Negro
101223	Jonhson	● Gris	101253	Mariner	● Gris Metalizado
101224	Jonhson	● Platinum 84	101254	Yamaha	● Azul Metalizado 84
101225	Jonhson 71-80	● Blanco	101255	Suzuki	● Gris 89
-	Evinrude 77-80	-	101256	Volvo Int	● Verde
101226	Selva	● Azul	101257	Aifo Int	● Rojo
101227	Selva	● Azul Metalizado	101258	Volvo Aq	● Gris 89
101228	Suzuki	● Gris	101259	Evinrude	● Azul Xp
101229	Volvo Aq	● Aquamatic	101260	Suzuki	● Negro Metalizado 98
101261	Caterpillar	● Blanco	101308	Iveco	● Blanco
101241	Parsum	● Negro	101248	Jonhson	● Plata

Antifoulings

Pintura Antivegetativa Velox Plus

Pintura antivegetativa para **Hélices, Colas, Ejes, Arbotantes, y todas las partes Metálicas sumergidas.**

Gran adhesión sobre metal desnudo o sobre pinturas originales. Óptimo poder antivegetativo. No contiene cobre ni otras sustancias que puedan crear corrientes galvánicas. Óptima capacidad de nivelación ya que no produce espesores que puedan variar el rendimiento hidrodinámico de las partes sobre las que se aplica.

Aplicación: Desengrasar el material disolvente y aplicar papel de lija grano 80-100. Una hélice nueva debe desengrasarse y lijarse a fondo. Aplicar dos manos a intervalos de 8h. En las partes sometidas a corrientes galvánicas es aconsejable dar una manos de METAL PRIMER 8h. antes.



Referencia	Descripción	Referencia	Descripción
108100	Velox 0,25lts blanco	108106	Velox 0,25lts gris
108101	Velox 0,50lts blanco	108107	Velox 0,50lts gris
108049	Velox 2,5lts blanco	108051	Velox 2,5lts gris
108103	Velox 0,25lts negro	108121	Velox 0,25lts naranja
108104	Velox 0,50lts negro	108122	Velox 0,50lts naranja
108053	Velox 2,5lts negro		

Velox Metal Primer

Imprimación para la pintura antivegetativa Velox Plus. Para metales especialmente diseñada para utilizarla antes del Velox Plus.

Aplicación en bronce, acero, aluminio, pero también sobre barnices de fábrica de pies de popa o sobre ciclos protectores epóxicos. Se aplica una sola mano. Aplicación en brocha o pistola. Color verde.



Referencia	Descripción	Referencia	Descripción
108109	Velox Metal Primer 0,25lts	108110	Velox Metal Primer 0,50lts
108111	Velox Metal Primer 2,5lts		

Productos Epóxicos

Diluyente nr. 2

108175 0,5Lts 108151 1Lt 108179 2,5Lts

Para antiincrustantes: Marlin TF, Super 505, Marlin Hard, Marlin CF, Maxima, 303, Tritón y universal primer.

Diluyente nr.4

108182 0,5Lts 108118 1Lts 108183 5Lts

Para esmaltes de poliuretano. Esmaltes y barnices Evergloss, esmalte y antiincrustante Flexy, Velox Plus, Metal Primer y Primer Fibra.



Descubre la eficacia excepcional de **VELOX PLUS**



Hélices tratadas con VELOX PLUS después de 1 año en el mar.

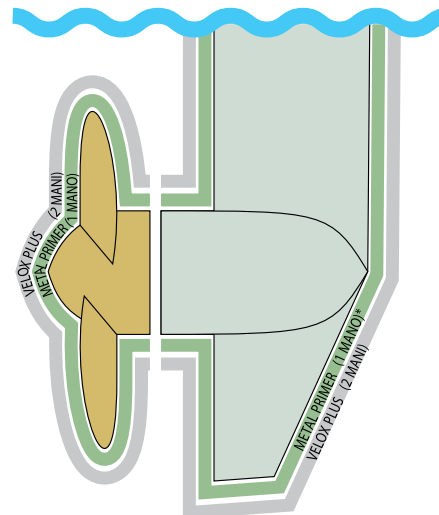
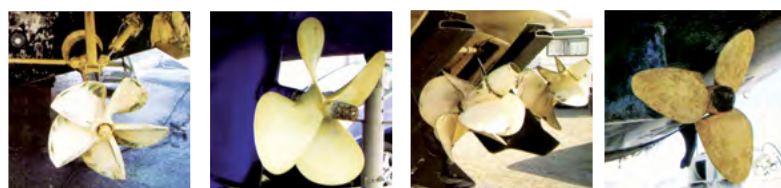

Helices, ejes y colas

Preparación de la superficie:

1. Preparación de la superficie
 - 1.1 Eliminar todo el antiguo antiincrustante u otros barnices con papel de lija de grano 80, a mano o con la ayuda de una lijadora orbital, teniendo cuidado de no dañar la hélice u otras partes metálicas. No retire el antiguo **Velox Plus** de la temporada anterior (vease la recomendación del punto 3.2). Para hélices y componentes nuevos en el metal desnudo, vaya directamente al paso 1.2.
 - 1.2 Limpiar completamente todas las superficies metálicas con papel de lija de grano 80, renovandolo a menudo. Para las partes más amplias se puede utilizar una lijadora orbital, mientras que los puntos más difíciles de alcanzar se deben lijar a mano. No utilice papel de lija más grueso ya que podría dañar la hélice al eliminar demasiado metal, ni tampoco use papel de lija más fino ya que no lijaría bien la superficie.
 - 1.3 Limpie a fondo con un paño seco todas las superficies metálicas lijadas para eliminar el polvo y los residuos del lijado. Se puede dar una pasada adicional con un paño limpio humedecido con disolvente 102 antisilicona o acetona pura. Nunca use ácidos, otros disolventes o detergentes y no toque con las manos desnudas las superficies metálicas lijadas. La contaminación de la superficie podría reducir drásticamente la adherencia de Metal Primer.

Nota: Recomendamos que proteja las superficies de aluminio desnudo (superficies sin el antiguo barniz de fábrica) con un ciclo adecuado de epóxido. Las superficies tratadas con ciclo de epóxido y las superficies tratadas con barniz de fábrica, así como las superficies ya tratadas con Velox Plus del año anterior se deberán lijar ligeramente con fieltro abrasivo (tipo Scotch Brite) o papel de lija de grano fino (180-220).

Aplicación:

- 2.1 Aplique una ligera capa de **Metal Primer** (espesor de película húmeda de 90-100 micras, correspondiente a 25 a 30 micras seco). Los espesores más altos o un mayor número de capas podrían reducir la adherencia. Dejar secar por lo menos durante 3 horas a 20°C.
- 2.2 Aplicar una primera mano de Velox Plus. La primera capa de Velox Plus tiende a disolver ligeramente la pintura de fondo, por lo que es normal no tener una cobertura perfecta y entrever el Metal Primer. Se recomienda aplicar la primera capa de Velox Plus con pinceladas largas y continuas, sin repasar demasiadas veces en los mismos puntos y sin insistir para lograr el recubrimiento.
- 2.3 Después de 3 horas a 20°C, aplicar una segunda mano de Velox Plus. Le recomendamos aplicar la segunda mano con pinceladas largas y continuas en sentido perpendicular a las pinceladas de la primera mano, siempre que sea posible. Se puede aplicar una tercera capa, especialmente en zonas con un alto crecimiento de vegetativa, de la misma forma que la segunda mano.
- 2.4 Esperar por lo menos 12 horas a 20°C para la botadura.

Sugerencias:

- 3.1 Prepare cuidadosamente todas las superficies: en el momento de la aplicación de la pintura de fondo, las superficies deberán estar bien ásperas y limpias, sin trazas de grasa o de otros contaminantes, que podrían reducir la adherencia del Metal Primer (sudor, huellas digitales, agua, detergentes, ácidos, disolventes, grasas, suciedad).
- 3.2 Sobre la capa de Velox Plus de la temporada anterior se puede aplicar directamente el antiincrustante Velox Plus después de lavar y lijar ligeramente la superficie con papel de lija de grano medio (180-220). En cualquier caso, se recomienda retirar el antiincrustante cada 2-3 temporadas para evitar la acumulación y por lo tanto espesores demasiados gruesos que podrían reducir la adherencia completa de la película. No aplicar Velox Plus directamente sobre el metal desnudo sin Metal Primer. No aplicar Velox Plus sobre antiincrustantes de otro tipo.
- 3.3 Mezclar cuidadosamente Velox Plus y Metal Primer antes de la aplicación. Ambos productos contienen pigmentos pesados que pueden sedimentarse.

MOTOR MANTENIMIENTO

Yachticon

- Diésel Plus
- Evita con componente Antifouling la formación de bacterias y lodo biológico y por lo tanto la obstrucción de tuberías, filtros e inyectores.
- Hasta 4% menos consumo de combustible y aumento de la potencia (aumento de índice de cetano).
- El motor funciona más suave y silencioso.
- Reduce el desgaste a través del engrase adicional; muy efectivo.
- Proporción de la mezcla: 1:1.000
- 02073900
- Botella 500ml. Para 500lts.
- 0207391934
- Botella 1l. Para 1.000lts.
- 0207391532
- 1 bidón 2,5lts. Para 2.500lts.
- 0207390788
- 1 bidón 5lts. Para 5.000lts.
- 0207391017
- 1 bidón 10lts. Para 10.000lts.



GROTAMAR 82

- Especialmente desarrollado para combustibles diesel modernos como el diesel con bajo contenido de azufre y mezclas biodiesel.
- Formula protectora para retrasar la degradación de los oleos provocados por el envejecimiento.
- Rápido y muy eficaz contra bacterias, hongos y levaduras.
- Excelente protección a largo plazo de los depósitos, tuberías y motores.
- Excelente solubilidad y distribución en todos los tipos de combustible diesel y biodiésel.
- Sin productos corrosivos de combustión.
- Protege de forma eficaz acero, aluminio y otros metales no ferrosos contra la corrosión.
- Dosificación de choque: Añadir 200 ml. De grotamar por cada 200 lts. de combustible ó 1 lt. Por cada 1.000 lts. de combustible.
- Dosificación de prevención: Añadir 200 ml. de Grotamar por cada 800 lts. de combustible ó 1 lt. por cada 4.000 lt. de combustible cuando se rellene el tanque.



02194100

Botella de 1 lt.

ABSORBENTE DE AGUA CONDENSADA PARA DIÉSEL + GASOLINA

02212300

- Absorbe hasta el 1% del agua del combustible y proporciona una combustión segura, evita la corrosión y la formación de lodo en los depósitos, las tuberías y los inyectores.
- Evita reparaciones costosas a causas de daños por el agua.
- Evita bacterias en los depósitos de diésel.
- Muy efectivo: proporción de mezcla 1:1.000. Botella 500ml.



GASOLINA PLUS

02214300

- Evita residuos dañinos en el carburador, las válvulas, los inyectores, las bujías y la cámara de combustión.
- Evita sonidos raros y funcionamiento irregular, proporciona pleno rendimiento.
- Protege contra la corrosión y la formación de hielo en el carburador.
- Reduce los contaminantes en el gas de escape.
- Idóneo también para el catalizador y el turbo.
- Proporción de la mezcla: 1:500. botella 500ml



CONSERVANTE DURADERO PARA DIÉSEL

02193100

- Conserva el combustible diésel durante el almacenaje.
- Para todas las propiedades de diésel y diésel super.
- Ideal durante el almacenaje o en periodos largos de paro.
- Protege contra la formación de sedimentos, humo y Fouling durante el periodo invernal.
- Estabilización de combustión a largo plazo a través de filtros e inyectores con funcionamiento seguro.
- Proporción de mezcla: 1:1.000. Botella 500ml.



LIMPIADOR PARA EL SISTEMA GASOLINA

02213200

- Aditivo limpiador altamente concentrado para la gasolina normal y super (DIN 51600/51607), limpia las válvulas, el carburador y los inyectores.
- Garantiza un consumo de combustible reducido, una combustión con menos contaminantes y un funcionamiento seguro, protege contra la corrosión.
- Reduce el consumo de combustible y proporciona más potencia del motor.
- Proporción de mezcla 1:1250. Consejo: aplicar antes y después del almacenaje de invierno. botella 500ml.



LIMPIADOR PARA EL SISTEMA DIÉSEL

02213000

- Aditivo altamente concentrado para la limpieza de todas las propiedades de diésel y diésel super (DIN 51601); elimina residuos en los inyectores, bombas de inyección y en todo el sistema de combustible.
- Se debería aplicar antes y después del invierno.
- Proporciona un consumo reducido.
- Reduce el "golpeo", protege contra la corrosión.
- Proporción de la mezcla: 1:250. Botella 500ml.



MOTOR MANTENIMIENTO

Yachticon



LIMPIADOR DE SISTEMA DE REFRIGERACIÓN

02456800

- Limpia los sistemas de refrigeración con uno o dos circuitos y los termocambiadore; elimina todos los residuos de sal, cal y óxido.
- Proporciona una refrigeración y seguridad de funcionamiento óptimo.
- Compatible con todos los materiales.
- Proporción de la mezcla: 2 lts son suficientes para sistemas de refrigeración hasta 60lts. (100ml para 3,5lts)



EVITA LAS PÉRDIDAS DE ACEITE

02172300

- Devuelve a las juntas su elasticidad.
- Para todos los motores de gasolina y diésel.
- Reduce el consumo de aceite.
- Protege la sentina contra los daños del medio ambiente y contra la suciedad.
- Proporción de la mezcla: 500ml son suficientes para 7,5lts. de aceite. botella 500ml.



CONSERVAR EL MOTOR + EL CARBURADOR

02214400

- Protege los motores y carburadores desde el exterior contra las influencias dañinas del medio ambiente, humedad y corrosión durante el invernaje o la inmovilización. Idóneo para todo tipo de materiales. Bote 400ml.



ARRANQUE RÁPIDO

02170300

- Ayuda de arranque con cualquier tipo de temperatura.
- Idóneo para todos los motores de gasolina y diésel.



CONSERVAR EL INTERIOR DEL MOTOR

02456900

- Para la conservación del interior de motores de 2 y 4 cilindros durante la inmovilización temporal o de larga duración.
- Mantiene los émbolos, juntas y cilindros libres de óxido y corrosión.
- Protege contra la radiación UV, sal y otras influencias dañinas del medio ambiente. bote 400ml.



Lubricante TK-1

101265

Penetra y disuelve el óxido permitiendo el desmontaje de las partes mecánicas y tornillería.

Expele la humedad y protege la oxidación de las partes eléctricas facilitando los contactos. No ataca las materias plásticas y barnices. No contiene silicona. Envase de 400ml.



Lubricante TK-2

101267

Reduce el mantenimiento, su acción de protección se mantiene durante 1 año. Protege los motores y los equipos mecánicos que trabajan en ambientes marinos o corrosivos. No ataca la goma, las pinturas y las materias plásticas.

Lubricante TK-3

101268

Lubricante especial con altas prestaciones, que se prestan de manera especialmente óptima al mantenimiento y protección de partes mecánicas en movimiento continuo, operando en condiciones ambientales difíciles. Lubrica en seco, creando un film protector de elevada durabilidad y resistencia a la acción mecánica que preserva las partes tratadas de la corrosión. Ideal para el ambiente marino, gracias a su total adhesividad e hidropelencia. Envase de 40ml.

Lubricante Synt

101269

Lubricante de síntesis. Excelente viscosidad a altas temperaturas. Puede operar en condiciones extremas de temperatura y fricción. Bajo índice de congelación y alta protección contra la corrosión. Especialmente indicado para cambios, engranajes cadenas de transmisión y otros equipos mecánicos que trabajen en duras condiciones. Temperatura de trabajo -15°+250°. Envase de 400ml.



Aceite Engranajes

Aceite de altísima calidad muy apto para el engrase de las cajas de transmisión de fuerabordas y colas intra/fuerabordas.

Contiene aditivos antioxidantes para guardar invariadas las características del aceite en los periodos de inactividad. Aditivo antidesgaste y presión extrema para reducir el desgaste de las partes metálicas en contacto. Supera las especificaciones OMC 1632.

101275

Envase tubo de 250ml.

101276

Envase bidón de 25lts.



Grasa

Grasa blanca a base de zinc.

Gracias a su fuerte adhesividad y a la gran cantidad de zinc.

Contenido en esta grasa en **muy conveniente para proteger, engrasar y evitar el bloqueo de bulones, bornes de Baterías, cierres y equipos que trabajan en ambientes corrosivos** y sometidos a la acción deslavante del agua.

101272

Envase tubo de 250ml.

101273

Envase bidón de 5lts.



Grasa

Grasa Premium Marine formulada específicamente para aplicaciones marinas.

189200

Fórmula Premium de litio para óptima protección a la corrosión en aplicaciones en agua dulce y salada. Ideal para cojinetes de remolques, cardanes y pivotes de colas. Tubo de 283,5gr.



Grasa

MER8M0121966

La grasa marina Quicksilver 2-4-C con teflón es una grasa NLGI 2 de alta calidad, extremadamente versátil, con base de litio, que no se descompone al mezclarse con agua.

- Una excelente resistencia a la oxidación y la degradación
- Aditivos para presión extrema que soportan la fricción en una amplia variedad de operaciones y temperaturas.

Puede aplicarse a los siguientes componentes marinos:

- Sistemas de dirección y articulaciones de cables
- Cables y articulaciones del acelerador y cambios
- Controles remotos
- Ejes de hélice
- Pasadores giratorios
- Mecanismos de bloqueo de la inclinación y tubos de inclinación
- Pasadores de bisagra
- Cojinetes de rueda para remolque de barco



02456900



1895503



Aceite Invernaje

Protege las partes internas del motor de la oxidación y de la corrosión. Especialmente diseñado para la protección estacional de los motores intraborda y fueraborda. Ideal para motores de 2 y 4 tiempos. Proporciona una protección química con una película sobre la superficie sin dejar residuos grasos.

02456900

Envase de 340gr.

1895503

Envase 3,8lts

189502



189503



Aceite Motor 2 tiempos

Aceite "Blue" Premium TC-W3 lubricante de altas prestaciones. Ideal para sistemas de inyección o pre-mezcla, óptimo quemado para la combustión sin humos. Deslizante más rápido, combustión más limpia. Reduce significativamente la toxicidad en el mar, comparado con otros aceites fueraborda del mercado. Máxima lubricación. Reduce la fricción de aros, la formación de depósitos de carbónilla y bloqueo de válvulas de escape. Ideal para fuerabordas actuales de altas potencias que necesitan las máximas prestaciones.

Sintético para motores BRP E-Tech / Universal.

189502

Envase de 946ml.

189503

Envase de 3,78lts.

1895402

Sintético. Envase de 946ml.

1895403

Sintético. Envase de 3,78lts.

189422



189423



Aceite Motor Fueraborda 4 Tiempos

Aceite 10W-30 para motores fueraborda de 4 tiempos. Formulado con una base Premium y con aditivos altamente refinados. Especialmente formulado para los motores marinos de 4 tiempos Mercury, Yamaha, Johnson-Evinrude, Suzuki y Honda. Reduce la fricción. Protección máxima frente la corrosión. La baja temperatura del fluido ofrece mejor arranque en frío. Mantiene el motor limpio y mejora su eficiencia. **Cumple las normativas API SJ, CF-2, CH4.**

189422

Envase de 946ml. Mercury 92-802833Q1

189423

Envase de 3,78lts. Mercury 92-802835Q1

1896902

Envase de 946ml. Sintético.

1896903

Envase de 3,78lts. Sintético.

1895536

Envase de 61lts.



Lubricante Power Trim&Tilt 189750

Formulado para operar a altas Presiones. Aditivos antiespuma aseguran un fluido uniforme. Diseñado para aplicaciones sujetas a cambios de temperatura.



Aceite Motor Intraborda 4 Tiempos

Aceite 25W-40 para motores Intraborda 4 tiempos. Formulario para dar una excelente lubricación y protección contra la corrosión. Este producto está desarrollado para el ambiente marino y es el adecuado para motores de 4 tiempos standard. Los beneficios para su motor son una reducción del desgaste de sus componentes internos, protección frente la corrosión, pistones más limpios. Baja temperatura de operación. Recomendado para motores mercruiser, OMC y Volvo Penta. **Cumple las normativas API SJ, CF-2, CH4.**

189402

Envase de 946ml. Mercruiser 92-802837Q1

189404

Envase de 4,7lts. Mercruiser 92-857389-A1

1894402

Sintético. Envase de 946ml. Mercruiser 92-883724K01

1894404

Sintético. Envase de 4,7lts. Mercruiser 92-883725K01

1895532



Aceite de Motor Diésel 15W-40

Primer aceite diésel ofrecido por Sierra. Con las siguientes especificaciones de fabricación: Volvo VDS-3; Cummins CES200078, CES200077, CES200776; Detroit Diésel DDC93D124; Cat ECF-2, ECF-1; Global DHD-1. Mayor cantidad de detergente para combatir hollín y depósitos de carbón. Certificada por APC CL-4 + Rating. **Se ajusta a las normas más exigentes de gasóleo en la industria marítima.**

1895532

1 lt.

1895533

3,8lt.

1895535

18,9lts

1895536

61 lt.

1895537

208lts.

189600



189602



189605



Aceite Colas "Premium"

Lubricante Premium para colas recomendado para todas las aplicaciones marinas en general que requieran lubricante clase GL-5. Ideal para reemplazar todas las antiguas aplicaciones de hypoid 90. Formulado para usar en aplicaciones standard, reduce la fricción y protege los engranajes, cojinetes y otros componentes.

Reemplaza: Mercury (Quicksilver). Premium Blend. OMC (system Matched). Hi-Vis lubricant. Yamaha (Yamalube). LUB-GEAR-11-04

189600

Envase de 283,5gr

189602

Envase de 946ml.

189605

Envase de 18,95lts.

189650



189652



189655



Aceite Sintético Colas

Lubricante sintético para colas que reduce la fricción incrementado las prestaciones y protegiendo los engranajes, cojinetes y otros componentes. Recomendado para uso en condiciones de operación de altas prestaciones, en colas de fueraborda e intrabordas.

Reemplaza: Mercury (Quicksilver). OMC (system Matched). Hi-Performance Blend. Hi-Vis lubricant. Yamaha (Yamalube). LUB-GEAR-11-04

189650

Envase de 283,5gr

189652

Envase de 946ml.

189655

Envase de 18,95 lts.

1895528



Aceite 25W-40

Semi-sintético para motores MERCURY VERADO.

1895528

Envase de 1 lt.

1895523

Envase de 4 lts. Mercury 92-858084 K01.

1895526

Envase de 61 lts.

189443



189448



Aceite 25W-40

Sintético para motores fueraborda.

189443

Envase de 4 lts. Mercury 92-883723K01.

189448

Envase de 946ml . Mercury 92-883722K01.

1895513



1895512



Aceite 10W-40

Semi-sintético para motores SUZUKI.

1895512

Envase de 946ml. Suzuki 990C0-10W40-1 QT.

1895513

Envase de 3,78 lts. Suzuki 990C0-10W40-1 GL.

1895516

Envase de 61 lts.

1895517

Envase de 208 lts.



1894104

1894102



Aceite SAE 30

Sintético para motores intraborda diesel y gasolina.

1894102

Envase de 946ml. Volvo 3842343.

1894104

Envase de 4,7 lts. Volvo 3842344.

1896802



Aceite de engranajes

Sintético formulado para reducir el desgaste.

1896802

Envase de 946 ml. Volvo 1141679

1896805

Envase de 19 lts. Volvo 114681.



Manguera de Combustible

Tubo de goma para el transporte de carburante (diésel o gasolina). Conforme según normativa ISO 7840: 2004 A1 CE. Temperatura de -30 °C a 100°C. Resistente a la abrasión de los agente marinos.

Ø	Ref. Tramo	Ref. Granel
6mm	1360001 -10mts	136000 -40mts
8mm	1360011 -10mts	136001 -40mts
10mm	1360021 -10mts	136002 -40mts
12mm	1360031 -10mts	136003 -20mts
16mm	1360041 -10mts	136004 -40mts
19mm	1360051 -10mts	136005 -20mts
25mm	1360061 -10mts	136016 -20mts
30mm	1360071 -10mts	136017 -20mts
32mm	1360081 -10mts	136018 -20mts
35mm	1360091 -10mts	136019 -20mts
38mm	1360201 -10mts	136020 -20mts
40mm	1360211 -10mts	136021 -20mts
45mm	1360221 -10mts	136022 -20mts
51mm	1360231 -10mts	136023 -20mts
60mm	1360241 -10mts	136024 -30mts



Bomba de Aceite

189788

Bomba para utilizar en fuerabordas e intrafuerabordas. Diseñado para utilizar en envases Ref. 189605 y Ref. 189655 y Bidones.



Bomba de Aceite

189781

Bomba de aceite. Incluye terminales de aceite con línea de llenado flexible. Adaptable para utilizar en envases Ref. 189600 y Ref. 189652.

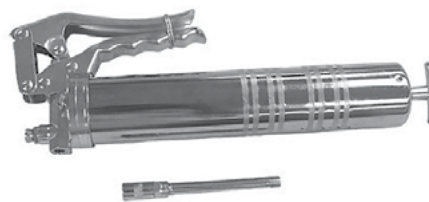

Pistola de Engrase

189782

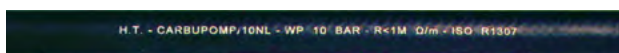

Manguera para Fuerabordas

Tubo de goma para motores fueraborda. Funcionamiento con gasolina sin plomo y diésel. Alta flexibilidad. Temperatura de -35°C a +90°C. ISO R-1307

Ø	Ref. Tramo	Ref. Bobina
6mm	1360141 -25mts	136014 -50mts
8mm	1360151 -25mts	136015 -50mts
10mm	1361161 -25mts	136116 -50mts

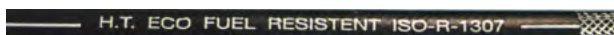

Manguera para Fuerabordas

Manguera de PVC para el trasvase de carburantes y alimentación de motores fueraborda. ISO R-1307

Ø	Ref. Tramo	Ref. Granel
7mm	1360831 -25mts	136083 -50mts
8mm	1360841 -25mts	136084 -50mts

BLOQUES DE MOTORES GM REMANUFACTURADOS

Los motores marinos están expuestos a condiciones de trabajo extremas. Muchos fabricantes de motores no tienen en cuenta los componentes especiales que éstos necesitan para satisfacer las duras exigencias del entorno marino.

Nuestro proceso de remanufacturación está adaptado para garantizar una navegación sin problemas, incluso para el trabajo más duro de motores marinos y barcos en cada uno de los ambientes marino.

Con más de cuarenta años de experiencia en el suministro a navegantes de motores marinos de alta calidad, aportamos fiabilidad y rendimiento a los navegantes de todo tipo.

Nuestros motores sustituyen a las marcas más populares del mercado como: **VOLVO PENTA, MARINE POWER, MERCUISER, PCM, CRUSADER, INDMAR.**

Además nuestros procesos de remanufacturación de alta calidad, líder en industria, aporta tranquilidad.

Aparte de nuestros procesos de remanufacturación de alta calidad, indicamos a continuación las características de los motores marinos:

- Falda de pistón recubierta de teflón hipereutéctico: para una óptima disipación, admite rango tolerancias.
- Conjunto con doble rodillo: fabricado en acero de alta resistencia, mejora del rendimiento y aumento de la durabilidad.
- Válvulas reforzadas: mejora el rendimiento y disminuye desgaste.
- Muelles de válvula reforzados: fabricados en aleación de alta resistencia, extremos reforzados, asegurando el funcionamiento tanto en el escape como la admisión.
- Bielas y cojinetes fabricados con materiales de 1ª calidad Aros de hierro maleable: los aros fabricados en hierro maleable disponen de una excelente resistencia trabajando sin necesidad de cobertura externa. Gran resistencia a las roturas.
- Juntas de culata reforzadas con anillos de acero: aunque el acero inoxidable es más costoso debido a sus ventajas (reduce la corrosión y optimiza la compresión) es una apuesta segura !

La garantía de los motores remanufacturados es de 1 año.

Motor 3.0 Seminuevo - MER8M0150086

Motores remanufacturados en base General Motors tipo 262 / 4.3L / 6 cilindros en V

Referencia	N° Bloque	N° Culata	Año aproximado	Descripción
262LA	14071177	14079268,107, 476, 768, 996	85-86	2 retenes traseros, tapa de válvula montada en el centro. Potencia estimada entre 175 y 205 hp.
262LB	553, 683	14079268, 066, 103, 107, 476, 768, 996	86-88	1 retén trasero, tapa de válvula montada en el centro. Potencia estimada entre 175 y 205hp.
262LC	011, 611, 867	066, 103, 107, 476, 768, 996	87-92	Bloque V generación, varilla en la parte derecha. Tuchos planos, 1 reten trasero. Potencia estimada de 205hp.
262LG	14099090	10235772, 12556140	92-97	Tuchos hidraulicos de rodillo con eje de balancín, 6 tornillos en tapa de distribución, retén trasero de una pieza, bomba de combustible eléctrica.
262LI	535, 10227196, 10227359, 10227534	10238181, 10240209, 14099064	96-99	Tuchos hidraulicos de rodillo con eje de balancín, 6 o 10 tornillos en tapa de distribución, reten trasero de una pieza. Bomba de combustible eléctrica.

Motores remanufacturados en base General Motors tipo Vortec 262/4,3L / 6 cilindros en V.

Referencia	N° Bloque	N° Culata	Año aproximado	Descripción
262LJ	090M	113	2000	Tuchos hidraulicos de rodillo. Culata con 8 tornillos de fijación al colector de admisión. Tapa cadena distribución de plástico. Bomba de combustible eléctrica.

Motores remanufacturados en base General Motors tipo 262/4.3L/6 cilindros en V.

Referencia	N° Bloque	N° Culata	Año aproximado	Descripción
262LF	061, 073, 756	064, 181, 209, 626	92-96	Lifter de rodillo sin eje calibrado. Bomba de combustible eléctrica. Potencia estimada entre 175 y 205 hp.
262LD	196, 359, 534, 535	064, 181, 209	92-97	Lifter de rodillo con eje calibrado. Numero de eje calibrado 10224542 o 10172748. Tiene 10 tornillos en la tapa de distribución. Bomba eléctrica. Potencia estimada entre 175 y 205 hp.
262LE	196, 359, 534, 535	064, 181, 209	95-99	Lifter de rodillo sin eje calibrado. Tiene 6 tornillos en la tapa de distribución, 14 en el carter de aceite y 12 en el colector de admisión. Bomba eléctrica. Potencia estimada entre 175 y 205 hp.

Motores remanufacturados en base General Motors tipo 305/5.0L/8 cilindros en V.

Referencia	Nº Bloque	Nº Culata	Año aproximado	Descripción
305LA	14016381, 14010203, 14010202, 14010201, 361797, 371, 776, 777, 778, 909, 979	14022601, 14022301, 14014416, 462424, 357841, 354, 434, 741	76-85	2 retenes traseros, tornillos de tapa de válvula montados en el perímetro. Potencia estimada entre 200 y 230 hp.
305LB	14102058, 14093627, 14088551, 535	14022601, 14022301, 14014416, 434, 741	85-87	Lifters planos, 1 reten trasero, tornillos de tapa de válvula montados en el perímetro. Potencia estimada entre 200 y 230 hp.
305LC	14102058, 14093627, 14088551, 535	14102187, 14101081	87-95	12 tornillos en colector de admisión, tapa de distribución metálica, 1 reten trasero, tornillos de tapa de válvula montados en el centro. Potencia estimada entre 185 y 220hp.

Motores remanufacturados en base General Motors tipo 305/5.0L/8 cilindros en V.

Referencia	Nº Bloque	Nº Culata	Año aproximado	Descripción
305LE	878	187	95-99	Con 8 o 10 tornillos en tapa de distribución de plástico. 12 tornillos en colector de admisión. Potencia estimada entre 200 y 230 hp.
305LF	878	059, 520, 620	96-99	Con 8 tornillos en colector de admisión. Tapa de distribución de plástico. Potencia estimada entre 200 y 230 hp.

Motores remanufacturados en base General Motors tipo 350/5.7L/8 cilindros en V

Referencia	Nº Bloque	Nº Culata	Año aproximado	Descripción
350LA	010, 014, 245, 379, 388, 618, 678	487, 624, 882, 993	67-85	Varilla en la parte derecha o izquierda del bloque, 2 retenes traseros, tornillos de tapa de válvula montados en el perímetro. Potencia estimada de 260 hp.
350LB	14101148, 14093638, 14088548, 10054727, 526	487, 624, 882, 993	86-87	1 retén trasero, tornillos de tapa de válvula montados en el perímetro. Potencia estimada de 260 hp.

Motores remanufacturados en base General Motors tipo 350/5.7L/8 cilindros en V

Referencia	Nº Bloque	Nº Culata	Año aproximado	Descripción
350LC	14101148, 14093638, 14088548, 10054727, 526	083, 193, 217	88-95	12 tornillos en el colector, 1 retén trasero, tornillos de tapa de válvula montados en el centro. Potencia estimada de 260 hp.
350LE	880	083, 193, 217	95-99	1 retén trasero, 12 tornillos colector de admisión, tapa de distribución de plástico, lifters de rodillo. Potencia estimada de 260 hp.
350LF	880	062, 906	95-99	1 retén trasero, 8 tornillos colector de admisión, tapa de distribución de plástico, agujero para bomba de combustible mecánica. Potencia estimada de 260 hp.

Motores remanufacturados en base General Motors tipo 454/7.4L

Referencia	Nº Bloque	Nº Culata	Año aproximado	Descripción
454LA	286, 289, 293, 321, 445, 512, 775, 959	039, 045, 049, 186, 236, 292, 326, 360, 416, 781	73-90	Bloque IV Gen.2 retenes traseros. Potencia estimada de 330 hp.
454LB	182, 297, 313	088, 156, 932	91-97	Bloque V Gen. 1 retén trasero. Potencia estimada de 330 hp.
454LC	182	088, 156, 923	91-97	Bloque V Gen., 1 retén trasero, 6 tornillos de distribución. Potencia estimada de 330hp.
454LD	297	279	96-99	Bloque V6 Gen., 1 retén trasero, 6 tornillos de distribución. Potencia estimada de 330hp.
454LE	297	156	96-03	Bloque VI Gen., 1 retén trasero, 6 tornillos de distribución. Potencia estimada de 330hp.

Motores remanufacturados en base General Motors tipo 502/8.2L

Referencia	Nº Bloque	Nº Culata	Año aproximado	Descripción
454LA	286, 289, 293, 321, 445, 512, 775, 959	039, 045, 049, 186, 236, 292, 326, 360, 416, 781	73-90	Bloque IV Gen.2 retenes traseros. Potencia estimada de 330 hp.



IDENTIFICANDO TIPO DE MOTOR BASE GM

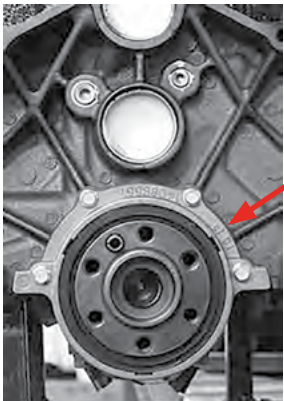
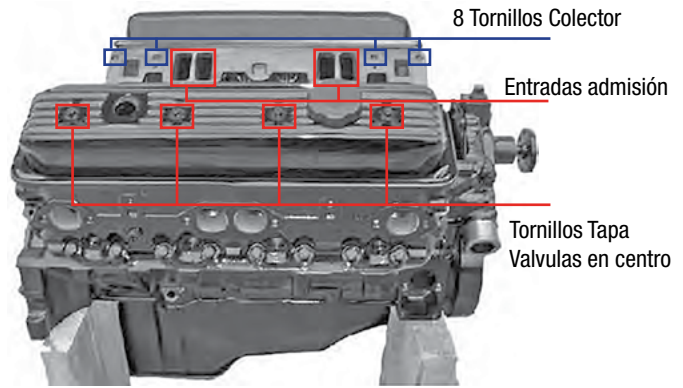
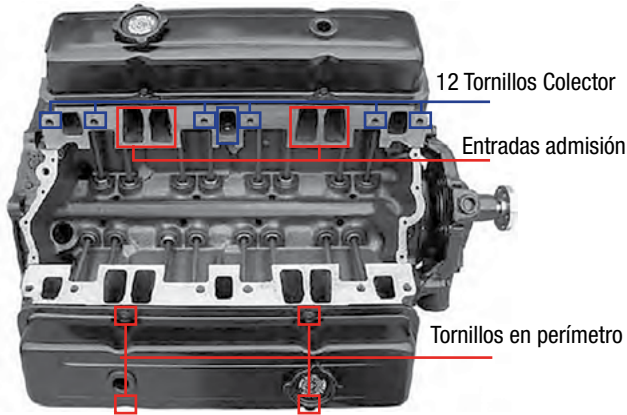

Retén trasero
1 pieza

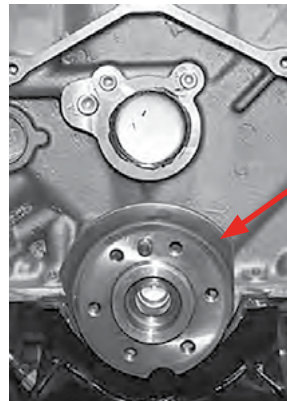

Retén trasero
2 piezas

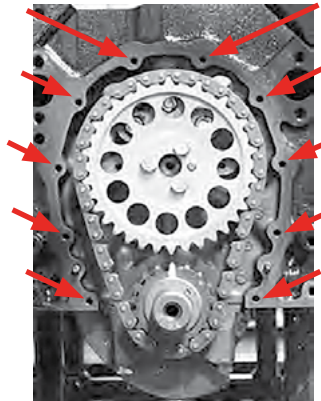

Tapa distribución
10 Tornillos

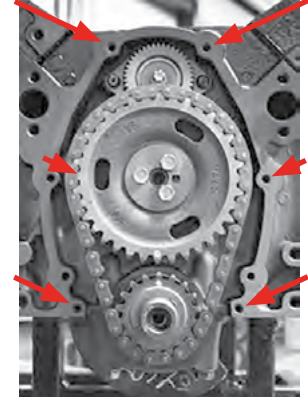

Tapa distribución
6 Tornillos

IDENTIFICANDO BLOQUE Y CULATA

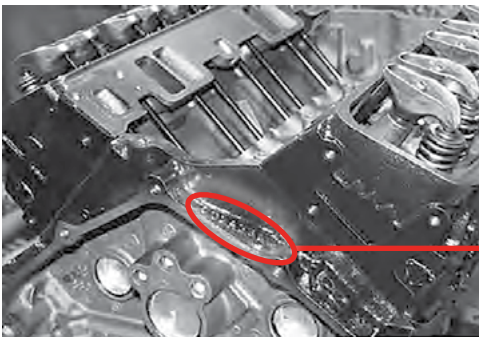

General Motors

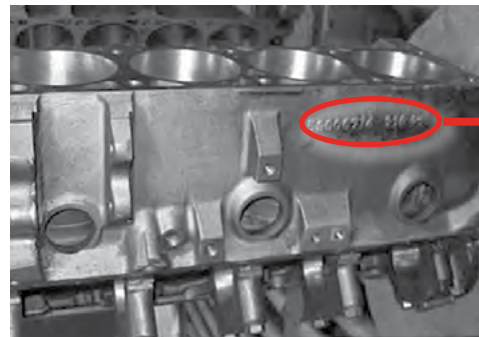

Ford, Chrysler

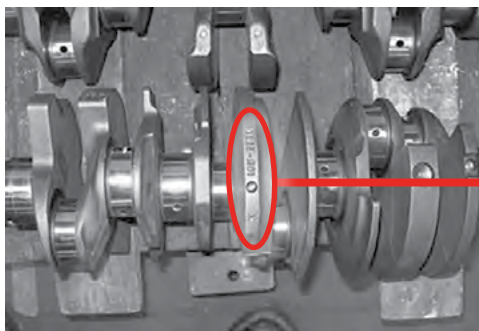



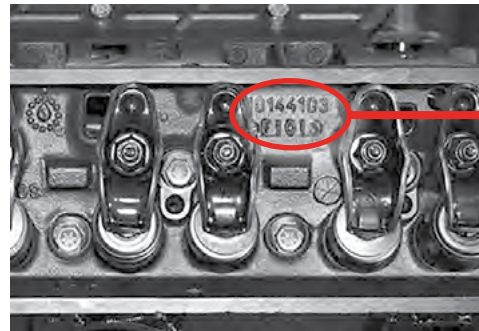







Crankshaft



Cylinder Head

HERRAMIENTAS

			REF. SIERRA	REF. MERCURY
	HINGE PIN TOOL	Reemplaza: Mercury 91-78310. Para el montaje y extracción de hinge pins de todas las colas Mercury.	18-9861	91-78310
	SPANNER NUT WRENCH	Reemplaza: Mercury 91-17256. Para el montaje y extracción de cojinetes retenedores de las colas MC-I,R-MR,Blackhawk,todas las Bravo y Alpha I.	18-9803	91-17256
	HERRAMIENTA FUELLES	Reemplaza: 91-45497A1. Para el montaje de fuelles de escape de colas MC-I,R-MR,Alpha One,Bravo uno y dos y Blackhawk.	18-9847	91-45497 A1
	LLAVE HELICE	Reemplaza: 91-821887A1,91-859046Q4 y 91-859046T4.	18-4459	91-859046q4
	LLAVE COJINETES	Reemplaza: 91-61069T. Para la instalación y extracción de cojinetes en colas Bravo Uno y dos,MC-I,R-MR,Alpha One,Alpha One/Gen II,TRS y fuerabordas.	18-9858	91-61069T
	ADAPTADOR TUERCA PIÑON	Reemplaza:91-61067A3.	18-9857	91-61067A04
	DRIVE GEAR SHIMMING TOOL	Reemplaza:91-60526T.	18-9856	91-60526T
	DRIVE SHAFT RETAINER WRENCH	Reemplaza: 91-43506T. Para la instalación y extracción de cojinetes en colas Alpha y fuerabordas.	18-9842	91-43506t
	ADAPTADOR EJE TRANSMISION	Reemplaza: 91-61077. Llave para girar el eje de la helice en las colas MC-I,R-MR,Alpha One,Alpha One/GenII, Bravo One y TRS.	18-9868	91-61077T
	TOMA DE AGUA	Para la limpieza de circuitos de refrigeración de motores con colas.	18-9010	
	HERRAMIENTA COJINETE	Reemplaza: 91-17257.	18-9809	91-17257

HERRAMIENTAS

			REF. SIERRA	REF. MERCURY
	HERRAMIENTA CABLE CAMBIO	Para instalar y extraer cables de cambio de MC-I,R-MR,Alpha One/Gen II. Reemplaza: Mercruiser 91-12037	18-9806E	
	LLAVE CAZOLETA	Reemplaza: Racor RK22628. Para cazoletas Sierra,Racor y otras marcas.	LLAVE 18-9884 CAZOLETA 18-7987	
	BARRA PARA ALINEAR MOTORES	MERCUISER/ALPHA ONE	18-4442	
	TESTER COMPROBACIÓN CHISPA	4 CILINDROS	18-8960	
	AC/DC 600A CLAMP METER	Para la medicion de corriente AC/DC con una desviacion minima de 0.1A hasta 600A. Ideal para testear motores electricos,bombas de combustible,sistemas de carga,alternadores etc.	18-9908	
	KIT ABRAZADERAS	Reemplaza: 787133,787145.	189125	
	HERRAMIENTA AJUSTE CABLE CAMBIO	Reemplaza:Mercury 91-12427,91-12427T	18-9807	
	HERRAMIENTA PUESTA A PUNTO	Reemplaza: Mercury 91-99379. Comprueba la puesta a punto del encendido. Equipado con dos baterias portatiles.	18-9802	
	MAQUINA ELECTRONICA MEDIDOR DE COMPRESIONES		18-9900	

SEA RAY			FORD V8 (COLAS) Cont.		
MODELO NO.	S/N	AÑO	MODELO	S/N	AÑO
3.0L	B787205-B917529	1988	225-S (4bbl.)	3385721-4166999	1973-74
4.3L	B785483-B921276	1988	233	4173000-4902304	1975-77
4.3LX	B785981-B922330	1988	255	3258728-4175499	1971-74
5.7L	B784799-B917017	1988	GM V8 283, 327, 305 & 350 CID		
SRX5.7L, 350 Mag	B785241-B919012	1988	MODELO	S/N	AÑO
SRX7.4L, 454 Mag Alpha	B785149-B924857	1988	190	1564539-1730903	1963-64
SRX7.4L-H, 454 Mag Bravo	B721206-B919343	1988	898 (2bbl.)	4762210-6218461	1977-82
COLAS			898 (2bbl.)	6218462-B525981	1983-84
MODELO NO.	S/N	AÑO	200/5.0L (2bbl.)	6218462-F600999	1985-95
SRX7.4L, Alpha	B803866-C348032	1988	5.0L (2bbl.)	L015751-SUP	1998-SUP
SRX7.4L-H, Bravo	B803872-B999972	1988	5.0L EFI	L012052-L340000	1998-99
MOTORES INTRABORDA			228 (4bbl.)	4765100-5170008	1977-78
MODELO NO.	S/N	AÑO	228 (4bbl.)	5170009-6218461	1979-82
5.7L	B788204-B919356	1988	228 (4bbl.)	6218462-B525981	1982-84
7.4L	B788179-B913769	1988	230 (4bbl.)	6218462-B525981	1985-86
RENAULT 4 CILINDROS (COLAS)			230/5.0LX (4bbl.)	B525982-F600999	1987-95
MODELO	S/N	AÑO	225	1539620-2694014	1963-69
60	1887079-2049044	1965-68	250	2314301-2639854	1968-69
80	2049045-2851423	1966-69	255	4175500-4767999	1975-76
90	2851424-3226957	1970-72	250	4768000-4908849	1977
GM 4 CILINDROS (COLAS)			260/5.7L	4908850-6218461	1978-82
MODELO	S/N	AÑO	260/5.7L	621462-B525981	1982-86
110	1537370-2044033	1963-66	260/5.7L	B525982-F600999	1987-95
120	1666601-3377340	1964-72	5.7L (2bbl.)	F601000-SUP	1996-98
120	3377341-3770649	1972-73	5.7L EFI	F225560-SUP	1995-SUP
120	3770650-4952700	1974-77	5.7LX (4bbl.)	F601000-K999999	1996-97
120	4952701-5192048	1978	5.7LX EFI	F752400-K999999	1996-97
120	5192049-6229717	1979-82	5.7LX Bravo EFI	F800300-K999999	1996-97
120	6229718-6853913	1983-84	350 Mag. Alpha	A635178-B525981	1986-87
120	6853914-B531853	1985-86	350 Mag. Alpha	B525982-F600999	1987-95
120/2.5L	B531854-C853255	1987-89	350 Mag. Alpha	F601000-K001526	1996
140	2508261-6229717	1968-82	350 Mag. Alpha	K001527-K999999	1997
140/3.0L	6229718-C856558	1982-89	350 Mag. Alpha EFI	F800300-K999999	1996-97
3.0L/LX	C856559-SUP	1990-SUP	350 Mag. Bravo MPI	F415189-K999999	1995-97
MERCURY MARINE 4 CILINDROS (COLAS)			350 Mag. Bravo MPI	F602000-K999999	1996-97
MODELO	S/N	AÑO	(GEN +)	L010019-SUP	1998-SUP
470 (2bbl.)	4208730-5520114	1976-79	350 Mag. MPI (GEN+)	2851074-3385720	1969-72
470 (2bbl.)	5520115-6218036	1980-82	280TRS	4176250-4770199	1975-76
470 (2bbl.)	6218037-6916778	1983-84	300 Tempest	6668677-B430367	1985-86
170 (2bbl.)	6916779-SUP	1985-86	320 (EFI)	A543604-C622418	1987-89
165/3.7L (2bbl.)	6916779-SUP	1987-89	GM V8 427, 454, 502, 540 & 572 (COLAS)		
485 (2bbl.)	5685394-6218036	1980-82	MODELO	S/N	AÑO
488 (4bbl.)	6170297-6916778	1983-84	325	2278747-3780449	1969-72
190 (4bbl.)	6916779-SUP	1985-86	330	4623115-6083144	1977-81
180/3.7LX (4bbl.)	6916779-SUP	1987-89	330	6083145-B816450	1982-87
GM EN LÍNEA 6 CILINDRO (COLAS)			7.4L Bravo	B771113-D603117	1988-91
MODELO	S/N	AÑO	7.4L Bravo (Gen.V)	D603118-F800699	1992-96
140	1538930-1725960	1963	7.4L Bravo (Gen.VI)	F800700-K999999	1996-97
150	1666495-2048046	1964-66	7.4LX Bravo (MPI)(Gen.V)	F602010-F801999	1996
160	2048022-2770031	1967-69	7.4LX Bravo (MPI)(Gen.VI)	F802000-K999999	1996-97
165	2770032-5178958	1970-78	7.4L MPI (Gen.VI)	L010003-SUP	1998
165	5178959-5813433	1979-81	7.4LX Bravo (TBI)(Gen.VI)	F820000-K999999	1996-97
200	2453769-2712072	1969	454 Mag. Alpha	A631894-SUP	1986-88
GM V6 (COLAS)			454 Mag. Bravo (Gen.V)	D805069-F304999	1992-94
MODELO	S/N	AÑO	454 Mag. Bravo (Gen.V)	F305000-F801699	1995-96
185 (4bbl.)	6330183-6919655	1983-84	454 Mag. Bravo (Gen.VI)	F801700-K999999	1996-97
185 (2bbl.)	A331455-B527954	1985-87	454 EFI (Gen.V)	F115700-F802349	1994-96
175/4.3L (2bbl.)	B527955-D714106	1987-92	454 Mag. MPI (Gen.VI)	F802350-K999999	1996-97
4.3L (GEN II)(2bbl.)	D714107-F000877	1992-93	454 Mag. MPI (Gen.VI)	L010029-L085399	1998
4.3L (GEN II)(2bbl.)	F000878-F601126	1993-95	454 Mag. MPI (Gen.VI)	L085400-SUP	1999-UP
4.3L (GEN II)(2bbl.)	F601127-F000878	1996	370 TRS	4179554-6721527	1978-85
4.3LX (GEN+)(2bbl.)	F803000-K999999	1996-97	370 TRS	6721528-B714586	1985-87
4.3L (GEN+)(2bbl.)	L010044-SUP	1998-SUP	400 TRS	4179554-B457644	1980-86
4.3L EFI (GEN+)(TBI)	L012009-SUP	1998-SUP	420	A398941-D937011	1987-89
205 (4bbl.)	A331455-B527954	1985-87	425	A398941-D937011	1990-93
205/4.3LX (4bbl.)	B527955-D714369	1987-91	440 TRS	4179554-B485220	1983-86
4.3LX (GEN II)(4bbl.)	D714370-F001219	1992-93	450 (Gen.V)	F347100-F347277	1995-96
4.3LX (GEN II)(4bbl.)	F001220-F601126	1993-95	525 SC	D456000-F348963	1991-92
4.3LX (GEN II)(4bbl.)	F601127-F802999	1996	525 SC (Gen.V)	D456000-F348963	1992-95
4.3LXH (GEN+)(4bbl.)	F803114-SUP	1996-97	525 SC (Gen.V)	F615814-F745215	1996
4.3LH(GEN+)(4bbl.)	L010044-SUP	1998	525 SC (Gen.VI)	F745260-SUP	1996-97
262 Mag. (TBI)(GEN+)	F803800-K999999	1996-97	390	2781129-3042731	1969-70
FORD V8 (COLAS)			460 TRS	4719554-6181046	1983-86
MODELO	S/N	AÑO	465	C849992-F213244	1990-92
888 (2bbl.)	3108723-4887829	1971-77	465 (Gen.V)	C849992-F213244	1992-94
215 (4bbl.)	2781153-3385720	1970-72	500 (Gen.V)	F213293-F745159	1994-96
225 (4bbl.)	3385721-4166999	1973-74			

GM V8 427, 454, 502, 540 & 572 (COLAS) Cont.		
MODELO	S/N	AÑO
500 (Gen.VI)	F745195-L001772	1997-98
502 Mag. Bravo	C878221-D824588	1990-92
502 Mag. Bravo (Gen.V)	D824589-F114528	1992-93
502 EFI (Gen.V)	D840650-F802599	1993-96
502 Mag.MPI (Gen.VI)	F802600-K999999	1996-97
500 EFI	L001477-SUP	1999-UP
502 Mag.MPI (Gen.VI)	L085433-SUP	1998
600 SC	D456489-F877642	1991-92
600 SC (Gen.V)	D456489-F877642	1992-96
600 SC (Gen.VI)	K000227-SUP	1997
500 Bulldog	C577254-F745405	1990-96
500 Bulldog	K000248-SUP	1997
575	A677429-D763716	1986-92
800 SC (Gen.V)	D763836-SUP	1993-96

MCM 4,5,6 & V8 CILINDRO MOTOR DIESEL COLAS			
MODELO	HP	S/N	AÑO
Rover	60	3140000F-SUP	1965-67
530 D-TA	150	B993000-B993492	1989
636 D-TA	180	B993500-C696047	1989
D183	140	B993493-D725149	1990-93
D219	170	C696048-D850124	1990-93
D254	200	C849484-D554729	1990-93
D3.0L	140	D725150-SUP	1994-SUP
D3.6L	170	D850125-SUP	1994-SUP
D4.2L	200	D554730-SUP	1994-SUP
D7.3L	238	F060000-SUP	1994-SUP

MERCURY MARINE MIE 4 CILINDRO (INTRABORDA)		
MODELO	S/N	AÑO
470	5520115-6218036	1980-81

FORD MIE V8 (INTRABORDA)		
MODELO	S/N	AÑO
215	2781153-3563181	1970-72
225	3385721-4176999	1970-72
233	4173000-4775784	1975-76
255	3258728-4178299	1973-74

GM MIE V8 305,327,350 CID (INTRABORDA)		
MODELO	S/N	AÑO
198	4762210-6218461	1977
228	4765100-5170008	1977-78
228	5170009-5907057	1979-80
230/5.0L (4bbl.)	5907058-B788151	1981-87
225	2278647-2694014	1968
250	2314301-2639854	1968-69
255	4175500-5907057	1975-80
260/5.7L	5907058-F024999	1981-93
270	2851074-3077735	1969-72
5.7L	F025000-K999999	1994-97
5.7L (Gen+)	L002003-SUP	1998
5.7L MPI	K040300-K999999	1997
350 Mag. MPI (Gen+)	L002008-L304499	1998
350 Mag. MPI (Gen+)	L304500-SUP	1999
350 Horizon	L304700-SUP	1999-UP
5.7L Ski	A338533-B514626	1985-87
5.7L Competition Ski	B514627-F775199	1987-95
5.7L Competition Ski	F775200-K040003	1996
5.7L Competition Ski	K040004-K999999	1997
5.7L Competition Ski (Gen+)	L002005-SUP	1998-UP
350 Mag. Ski	D505450-K999999	1991-97
350 Mag. EFI Ski	F215561-K999999	1994-97
350 Mag. MPI Ski	F350583-F799999	1995-98
Black Scorpion Ski	F800000-SUP	1996-98

GM MIE V8 427, 454, 482 & 502 CID (INTRABORDA)		
MODELO	S/N	AÑO
325	2278747-3780449	1968-74
330	4623115-5889913	1977-80
340/7.4L w/B/W MK4	5889914-SUP	1981-92
7.4L w/Hurth (LH) MK4	C391564-D715493	1989-92
7.4L (LH)	D715494-K999999	1992-97
7.4L MPI (LH)	F563052-K999999	1995-97
7.4L MPI (L29) Gen VI	L002006-SUP	1998
7.4L TBI (LH) Gen VI	F874815-K999999	1996-97
454 Mag. MPI Horizon	L002200-L086049	1998-99
454 EFI (SKI) (Gen.V)	F215800-F820099	1995-96
454 Mag. MPI (SKI)(Gen.VI)	F820100-K999999	1996-97
350	9780450-4623109	1974-76
390	2781129-2825059	1969-70
8.2L w/ Hurth	C878221-D857199	1990-92
8.2L (Gen.V)	D857200-F819619	1993-96
8.2L MPI (LH) Gen VI	F819620-K999999	1996-97

GM MIE V8 427, 454, 482 & 502 CID (INTRABORDA)		
MODELO	S/N	AÑO
8.2L MPI (LH) Gen VI	L002450-L0086012	1998
8.2L MPI (LH) Gen VI	L0086013-SUP	1999

MIE 5, 6 & V8 CILINDRO MOTOR DIESEL INTRABORDA			
MODELO	HP	S/N	AÑO
530 D-TA	150	B993002-C539258	1989
636 D-TA	180	B993750-C696011	1989
D183	150	C539259-D725149	1990-93
D219	180	C696012-D850124	1990-93
D254	210	C849461-D554729	1990-93
D3.0L	150	D725150-SUP	1994-SUP
D3.6L	180	D850125-SUP	1994-SUP
D4.2L	210	D554730-SUP	1994-SUP
D7.3L	262	F060000-SUP	1994-SUP

MC 60, 80 & 90 COLAS & TRANSOM PLATES		
MODELO	S/N	AÑO
60 (0)	1830753-2063740	1965-66
80	2063741-2898029	1966-69
90	2898020-3225967	1970-72

MC I, II & III		
MODELO	S/N	AÑO
I	1534570-1684187	1963
II (1.33:1)	1474909-2278488	1962-67

MC I, II & III Cont.		
MODELO	S/N	AÑO
II (1.78:1)	2398798-2671321	1968-69
III	2373127-3002613	1968-72
III	5128065-SUP	1978-SUP

MC 1A, 1B & 1C		
MODELO	S/N	AÑO
1A, 1B & 1C	1684188-1777798	1964
1A, 1B & 1C (E-Z Shift)	1776349-2065189	1965-66

MC 120, 140, 160 & 165		
MODELO	S/N	AÑO
120/140	2062141-378049	1967-73
120/140	3780850-4893634	1974-77
120/140	4893635-6225576	1978-82
160	2065190-2763441	1967-69
165	2763442-3780849	1970-73
165	3780849-4890459	1974-77
165	4890460-6268064	1978-82

MC470 & 485		
MODELO	S/N	AÑO
470	4208730-4893834	1976-77
470	4893835-6225576	1978-82
485	5487437-6225576	1980-82

MC 888, 225S & 233		
MODELO	S/N	AÑO
888	3106717-3784374	1971-73
888	3784375-4782329	1974-77
225S	3856268-4200499	1974
233	4200500-4782329	1975-77

MC 898, 228, 250 & 260		
MODELO	S/N	AÑO
898/228	4782330-4898729	1977
898/228	4898730-6229157	1978-82
250	4791300-4898729	1977
260	4898730-6229157	1978-82

MC R, MR, ALPHA ONE, ALPHA ONE SS & ALPHA ONE GEN II		
MODELO	S/N	AÑO
R	6152230-6847029	1983-84
MR	6810538-A479506	1985
Alpha One	A470165-SUP	1986-90
Alpha One SS	A545004-SUP	1986-89
Alpha One Gen II	D469859-SUP	1991-SUP

MC BRAVO & BLACKHAWK		
MODELO	S/N	AÑO
Bravo One	B664190-SUP	1988-SUP
Bravo Two	C564952-SUP	1989-SUP
Bravo Three	D763691-SUP	1993-SUP
Blackhawk	F186717-SUP	1994-SUP

MC 215E & 215H		
MODELO	S/N	AÑO
215H	2782203-2909034	1970
215E	2782203-2909034	1970-72

MC TR & TRS		
MODELO	S/N	AÑO
TR	3377316-3787239	1973
TR	3787240-4794899	1974-76
TR	4794900-5009866	1977
TR	5009867-SUP	1978-SUP
TRS	3787240-4203749	1974-75
TRS	4203750-4795399	1976
TRS	4795400-SUP	1977-SUP

Modelo identificación gráfico
MERCURUISER



18-5291
KIT ENCENDIDO
Reemplaza: 808483K2
Motores GM V-8 con Delco HEI-1998 y nuevos (excepto motores MPI con 555 ECM)
Incluye 18-5354 tapa & 18-5402 rotor



18-5246
KIT ENCENDIDO
Reemplaza: 898253T28
Para: Último modelo V-6, 4.3L (Alpha/Bravo)



18-5247
KIT ENCENDIDO
Reemplaza: 898253T29, 8M0061335, 8M0060495
Para: Último modelo V-8 (Alpha/Bravo 350, Mag, 5.0L, & MX 6.2L)



18-5252
KIT ENCENDIDO
Contiene:
Ref. Descripción
18-5310 Juego contactos
18-5344 Condensador
Rotor
Prestolite 8 cil.



18-5250
KIT ENCENDIDO
Reemplaza: 34235T1, 34235Q1
-CONTIENE-
Ref # O.E. # Descripción
18-5311 34235 Juego de contactos
18-5345 33662 Condensador
18-5418 58217 Rotor
Delco 4 & 6 cil.



18-5251
KIT ENCENDIDO
-CONTIENE-
Ref # O.E. # Descripción
18-5314 391-5090 Juego de contactos
18-5338 391-5092 Condensador
18-5404-1 391-7057 Rotor
Mallory 8 cil. Tapa alta



18-5253
KIT ENCENDIDO
-CONTIENE-
Ref # O.E. # Descripción
18-5318 58033 Juego de contactos
18-5346 58034, 81-64851 Condensador
18-5420 65864 Rotor
Autolite 8 cil.



18-5254
KIT ENCENDIDO
-CONTIENE-
Ref # O.E. # Descripción
18-5317 64850, 87-71831 Juego de contactos
18-5346 58034, 81-64851 Condensador
18-5420 65864, 78016 Rotor
Mercury 8 cil.



18-5258
KIT ENCENDIDO
-CONTIENE-
Ref # O.E. # Descripción
18-5303 392-6325 Juego de contactos
18-5347 392-6324 Condensador
18-5407 392-6326 Rotor
Prestolite 8 cil.



18-5260
KIT ENCENDIDO
-CONTIENE-
Ref # O.E. # Descripción
18-5303 392-6325 Juego de contactos
18-5345 392-6324 Condensador
18-5403 392-9767 Rotor
Prestolite 8 cil.



18-5266
KIT ENCENDIDO
Para: Distribuidores 18-5481, 18-5482, 18-5483, 18-5477, 18-5478 y 18-5479
Incluye 18-5300 rotor



18-5267
KIT ENCENDIDO
-CONTIENE-
Ref # O.E. # Descripción
18-5318 58033 Juego de contactos
18-5346 58034, 81-64851 Condensador
18-5420 65864, 78016 Rotor
18-5389 393-4988T Tapa distribuidor
Autolite V-8 - terminal único



18-5268
KIT ENCENDIDO
-CONTIENE-
Ref # O.E. # Descripción
18-5311 34235 Juego de contactos
18-5345 33662 Condensador
18-5418 58217 Rotor
18-5385 393-9459 Tapa distribuidor
Delco en línea 4 - terminal único



18-5269
KIT ENCENDIDO
-CONTIENE-
Ref # O.E. # Descripción
18-5311 34235 Juego de contactos
18-5345 33662 Condensador
18-5418 58217 Rotor
18-5386 33765 Tapa distribuidor
Delco En línea 6 - terminal único



18-5271
KIT ENCENDIDO
-CONTIENE-
Ref # O.E. # Descripción
18-5314 391-5090 Juego contactos
18-5338 391-5092 Condensador
18-5404-1 391-7057, 391-5088 Rotor
18-5376 391-5075 Tapa distribuidor
Mallory V-8 - Punto único - terminal único



18-5273
KIT ENCENDIDO
-CONTIENE-
Reemplaza: 805759T3 / 805759Q3
Ref # O.E. # Descripción
18-5431 13524A5 Rotor
18-5395 16457A4 Tapa distribuidor
Mercury Thunderbolt HEI - V-8



Display Package

**18-5274
KIT ENCENDIDO**
— CONTIENE —

Ref #	O.E. #	Descripción
18-5432	13524A6	Rotor
18-5396	13753A2, 815407A2	Tapa distribuidor Mercury Thunderbolt HEI - V-6



Display Package

**18-5275
KIT ENCENDIDO**
— CONTIENE —

Ref #	O.E. #	Descripción
18-5303	392-6325	Juego contactos
18-5347	392-6324	Condensador
18-5403	392-9089	Rotor
18-5352	392-9766	Tapa distribuidor

Prestolite V-8 - Sólo un platino - Tapa tornillos



Display Package

**18-5276
KIT ENCENDIDO**
— CONTIENE —

Ref #	O.E. #	Descripción
18-5303	392-6325	Juego contactos
18-5347	392-6324	Condensador
18-5403	392-9089	Rotor
18-5353	392-9086	Tapa distribuidor

Prestolite V-6 - Sólo un platino - Tapa tornillos



Display Package

**18-5277
KIT ENCENDIDO**
— CONTIENE —

Ref #	O.E. #	Descripción
18-5303	392-6325	Juego contacto
18-5347	392-6324	Condensador
18-5407	392-6326	Rotor
18-5369	392-6318	Tapa distribuidor

Prestolite V-8 - terminal único - Tapa tipo clip



**18-5278
KIT ENCENDIDO**
Reemplaza: 850484T3
Delco EST - V-6

— CONTIENE —

Ref #	Descripción	O.E. #
18-5362	Tapa distribuidor	850484
18-5408	Rotor	850485



**18-5280
KIT ENCENDIDO**
Reemplaza: 811635Q2
Delco EST - En línea 4

— CONTIENE —

Ref #	Descripción	O.E. #	Cant.
18-5361	Tapa distribuidor	811635, T3	1
18-5406	Rotor	811636, 1	1



**18-5281
KIT ENCENDIDO**
Reemplaza: 808483Q2
Delco EST - V-8

— CONTIENE —

Ref #	Descripción	O.E. #	Cant.
18-5354	Tapa distribuidor	808483	1
18-5405	Rotor	808484, 1, 898253010	1



**18-5282
KIT ENCENDIDO**
Holley, Mercury Marine -
Sólo un platino V-8

— CONTIENE —

Ref #	Descripción	O.E. #
18-5389	Tapa distribuidor	393-4988T, 2
18-5420	Rotor	65864, 78016
18-5317	Juego contactos	64850, 87-71831
18-5346	Condensador	58034, 81-64851



**18-5283
KIT ENCENDIDO**
Para: Mallory Sólo un platino 4 en línea

— CONTIENE —

Ref #	Descripción	O.E. #
18-5397	Tapa distribuidor	-
18-5404-1	Rotor	391-7057
18-5314	Juego de contactos	391-5090
18-5338	Condensador	391-5092



**18-5301
KIT ENCENDIDO**
Reemplaza:
Para: Tapón macho
V-8 flamethrower
distribuidor



**18-5302
KIT ENCENDIDO**
Reemplaza:
Para: Tapón macho
V-8 flamethrower
distribuidor



**18-5303
JUEGO DE CONTACTOS**
Reemplaza: 392-898253005,
392-6325, 8M6001219,
F16900031



**18-5311
JUEGO DE CONTACTOS**
Reemplaza: 34235, 34235T



**18-5310
JUEGO DE CONTACTOS**
Reemplaza: 33700



**18-5314
JUEGO DE CONTACTO**
Reemplaza: 391-5090,
391-898253004, 8M6001250



**18-5317
JUEGO DE CONTACTO**
Reemplaza: 64850,
87-71831



**18-5318
JUEGO DE CONTACTO**
Reemplaza: 58033,
898253007



**18-5338
CONDENSADOR**
Reemplaza: 391-5092,
391-898253001, 391-5093,
391-5092, 8M6001217
F16900040

 <p>18-5344 CONDENSADOR Reemplaza: 33706</p>	 <p>18-5345 CONDENSADOR Reemplaza: 33662, 898253003, 898253005, 33662Q, 6325, 8M6001218, FI6900031</p>	 <p>18-5346 CONDENSADOR Reemplaza: 58034, 81-64851</p>	 <p>18-5347 CONDENSADOR Reemplaza: 392-6324, 392-898253002, 8M6001249, FI6900023, FI6900032, FI6900083, FI6900189</p>	 <p>18-5402 ROTOR Reemplaza: 898253009 Motores GM V-8 con Delco HEI-1998 y nuevos (excepto motores MPI con 555 ECM)</p>
 <p>18-5245 ROTOR Reemplaza: 884790, 898253013 Para: Último modelo V-6, V-8 (Alpha/ Bravo 350 Mag, 5.0L, & MX 6.2L)</p>	 <p>18-5403 ROTOR Reemplaza: 392-9089, 392-9089T, 392-9767, 392-9089Q, FI6900186 FI6900190</p>	 <p>18-5404-1 ROTOR Reemplaza: 391-7057, 391-5088, 391-7057T, 391-898253029, 8M6001224, FI6901224</p>	 <p>18-5405 ROTOR Reemplaza: 808484, 808484 1, 898253010 Use con 18-5354 tapón distribuidor Para nuevos GM style "Modulo en tapa" distribuidores - V-8</p>	 <p>18-5406 ROTOR Reemplaza: 811636, 811636 1, 898253011 Use con 18-5361 tapón distribuidor 3.0L LX</p>
 <p>18-5407 ROTOR Reemplaza: 392-6326, 392-6326T, FI6900044</p>	 <p>18-5300 ROTOR Reemplaza: 33707 Para: Flamethrower Distribuidor</p>	 <p>18-5408 ROTOR Reemplaza: 850485, 8504851, 898253012, 8M0062084, 804424 Use con 18-5362 Tapa Distribuidor Para nuevos GM Style "Module in Cap" Distribuidores V6 Aplicaciones</p>	 <p>18-5418 ROTOR Reemplaza: 58217, 898253008, 58217Q</p>	 <p>18-5420 ROTOR Reemplaza: 65864, 78016</p>
 <p>18-5431 ROTOR Reemplaza: 13524A5, T1 V-8</p>	 <p>18-5432 ROTOR Reemplaza: 13524A6, 13524Q06, 13524A4, 19405A4, 90576A4 V-6</p>	 <p>18-5243 TAPA DISTRIBUIDOR Reemplaza: 888731, 898253T23 Para: Último modelo V-6 (4.3L Alpha/Bravo)</p>	 <p>18-5244 TAPA DISTRIBUIDOR Reemplaza: 884792, 858253T22 Para: Último modelo V-8 (Alpha/ Bravo 350 Mag, 5.0L, & MX 6.2L) Use juego cables 18-8821-1</p>	 <p>18-5352 TAPA DISTRIBUIDOR Reemplaza: 392-9766, 392-9766Q1, 392-9766T, FI6900185 Prestolite</p>
 <p>18-5353 TAPA DISTRIBUIDOR Reemplaza: 392-9086, 392-9086T</p>	 <p>18-5354 TAPA DISTRIBUIDOR Reemplaza: 808483, 808483T3, 804483T 804418 Para nuevos GM style "Modulo en tapa" Distribuidores-V-8 Use 18-5405 Rotor</p>	 <p>18-5361 TAPA DISTRIBUIDOR Reemplaza: 811635, 811635T3 Use 18-5406 Rotor 3.0L LX</p>	 <p>18-5362 TAPA DISTRIBUIDOR Reemplaza: 850484, 850484T, 850484T2 Para nuevos GM Style "Modulo en la tapa" Distribuidores - V6 Use 18-5408 Rotor</p>	 <p>18-5369 TAPA DISTRIBUIDOR Reemplaza: 392-6318, 392-6318T, FI6900184 Prestolite con juntas 18-5399</p>

① Referencias acabadas en "D" envasadas - Referencias normales no envasadas

APLICACIONES EMPIEZAN EN LA PÁGINA 40

 <p>18-5376 TAPA DISTRIBUIDOR Reemplaza: 391-5075, 391-5075Q1, FI6900148 Mallory</p>	 <p>18-5384 TAPA DISTRIBUIDOR Reemplaza: 33708</p>	 <p>18-5385 TAPA DISTRIBUIDOR Reemplaza: 393-9459, 393-9459Q1, 393-9459T, 33667, FI6900052</p>	 <p>18-5386 TAPA DISTRIBUIDOR Reemplaza: 33765, 33765T</p>
 <p>18-5389 TAPA DISTRIBUIDOR Reemplaza: 393-4988T, 393-4988T2, 393-4988, 393-3230</p>	 <p>18-5395 TAPA DISTRIBUIDOR Reemplaza: 16457A4, 805759T2, 805759T1, 805759A5, 805759A2, 805759A1, 90746A1, 43557A1, 43557 V-8</p>	 <p>18-5396 TAPA DISTRIBUIDOR Reemplaza: 13753A2, 815407A2 V-6</p>	 <p>18-5397 TAPA DISTRIBUIDOR Reemplaza: Mallory 9-29418 Para: Ford 2.3L con Mallory Distribuidor (87-90)</p>
 <p>18-5473 TAPA DISTRIBUIDOR Tapa distribuidor negro con terminales macho Flamethrower Distribuidores</p>	 <p>18-5474 TAPA DISTRIBUIDOR Tapa distribuidor rojo con terminales macho Flamethrower Distribuidor</p>	<p>Pack de 2</p>  <p>18-5399 18-5399-9 ① JUNTA TAPA DISTRIBUIDOR Reemplaza: 392-6329</p>	 <p>18-29417 TAPA DISTRIBUIDOR Reemplaza: Mallory 270B Para: Mallory 6 cilindro</p>

CARACTERÍSTICAS

- Relleno con aceite para mejor refrigeración y gran durabilidad
- Baja resistencia que produce una gran intensidad para un mejor encendido y economía de combustible
- Más hilos maximizan la energía y la fiabilidad sobre el rango de las RPM
- Se ajusta a los soportes existentes para una fácil instalación

 <p>18-5466 BOBINA ENCENDIDO DE ALTO RENDIMIENTO 1.5 ohm (aceite), negro - 8 cilindro: Flame-Thrower 40,000 voltios bobina.</p> <ul style="list-style-type: none"> • Usar con el kit de encendido de conversión electrónica original • Puede ser usado con otros sistemas de encendido 	 <p>18-5469 BOBINA DE ENCENDIDO DE ALTO RENDIMIENTO 3.0 ohm (aceite), negro - 4 & 6 cilindro: Flame-Thrower 40,000 voltios bobina.</p> <ul style="list-style-type: none"> • Usar con kit de conversión electrónica original • Puede ser usado con otros sistemas de encendido 	 <p>18-5472 BOBINA ENCENDIDO DE ALTO RENDIMIENTO 0,6 ohm (llenado aceite), negro - 4, 6, & 8 cilindros: Flame-Thrower 45,000 voltios bobina.</p> <ul style="list-style-type: none"> • Bobina de baja resistencia 0,6 ohm diseñada para usar con kits de conversión electrónica de alto rendimiento ignitor II
-------------------------------------------------------------------------------------------------------------------------------------------------------------------------------------------------------------------------------------------------------------------------------------------------------------------------------------------------------------------------------------------------------------------------	--------------------------------------------------------------------------------------------------------------------------------------------------------------------------------------------------------------------------------------------------------------------------------------------------------------------------------------------------------------------------------------------------------------------	---------------------------------------------------------------------------------------------------------------------------------------------------------------------------------------------------------------------------------------------------------------------------------------------------------------------------------------------------------------------------------------------------------------------------------------------

Ref No.	Descripción	Bobina recomendada	Resistencia Ohms	Ref No.	Descripción	Bobina recomendada	Resistencia Ohms
18-5294	Kit conversión electrónica	18-5469	3	18-5286	Kit conversión electrónica alto rend.	18-5472	0.6
18-5295	Kit conversión electrónica	18-5469	3	18-5288	Kit conversión electrónica alto rend.	18-5472	0.6
18-5296-2	Kit conversión electrónica	18-5466	1.5	18-5289	Kit conversión electrónica alto rend.	18-5472	0.6
18-5297	Kit conversión electrónica	18-5469	3	18-5290	Kit conversión electrónica alto rend.	18-5472	0.6
18-5298	Kit conversión electrónica	18-5466	1.5	18-5481	Flame-Thrower Distribuidor	18-5472	0.6
18-5299	Kit conversión electrónica	18-5466	1.5	18-5482	Flame-Thrower Distribuidor	18-5472	0.6
18-5285	Kit conversión electrónica Alto rend.	18-5472	0.6	18-5483	Flame-Thrower Distribuidor	18-5472	0.6

TABLA APLICACIONES EMPIEZAN EN LA PÁGINA 40

 <p>18-5433 BOBINA ENCENDIDO Reemplaza: 38547, 32193A2, 392-806529A1, 898253T24 DELCO 1115202 (Utiliza resistencia externa)</p>	 <p>18-5438 BOBINA ENCENDIDO Reemplaza: 392-7803A4, 392-805570A2 HEI Thunderbolt encendido</p>	 <p>18-5465 BOBINA ENCENDIDO Reemplaza: 392-863704T, 8M0054588 2001 y nuevos 4.3L, 5.0L, 5.7L & 6.2L con 555 ECM (OM300000 y sup)</p>	 <p>18-7493 BOBINA Reemplaza: 392889925 Para: 8.1L & 496 Mag OM315053 & SUP</p>	 <p>18-7648 BOBINA ENCENDIDO Reemplaza: 392-881732</p>
 <p>18-5442 BOBINA ENCENDIDO Reemplaza: 806673T, T1</p>	 <p>18-5443 BOBINA ENCENDIDO Reemplaza: 817378T, 817378, 898253T27</p>	 <p>18-5117 MODULO DE ENCENDIDO Reemplaza: GM 10482803 Para: MCM MIE 4.3L MPI, 5.0L MPI, 350 Mag MPI y MX 6.2L MPI motores con ECM555 (2001 & sup) S/N OM300000 & sup</p>	 <p>18-5107-1 MODULO ENCENDIDO 4/6/8 cil. Reemplaza: 811637001, 811637002, 811637T, 811637, 850487, 804412, 802464 Delco EST</p>	 <p>18-5464 MODULO ENCENDIDO Para: Sierra 18-5481, 18-5482 and 18-5483 pico DISTRIBUIDORES ELECTRONICOS DE ALTO RENDIMIENTO (excepto HEI/EST)</p>
 <p>18-5488 MODULO ENCENDIDO Modulo de reemplazo para distribuidores electronicos Mallory</p>	 <p>18-5108 SENSOR BOBINA DE PICK-UP Reemplaza: 811639, T V4/V6/V8 Delco EST</p>	 <p>18-5116-1 KIT SENSOR ENCENDIDO Reemplaza: 87-861780A2, Q4, 87-892150A02 Para: V-6 & V-8 con Thunderbolt encendido (1981-1997) conector tuercia</p>	 <p>18-7556 CIGÜÑAL SENSOR Reemplaza: 864297001 Para: Mercury 5.0L, 6.2L 1998-2010</p>	 <p>18-7642 ENS. PICK-UP Reemplaza: 898141 Para: Motores equipados con Delco HVS distribuidor</p>
 <p>18-26810 GM HEI 4 TERMINAL Para: GM HEI Distribuidor con 4 terminales</p>	 <p>18-26811 GM HEI 2 TERMINAL Para: GM HEI Distribuidor con 2 terminales</p>	 <p>18-26812 HEI BOBINA CONECTOR</p>	 <p>18-26813 HEI BOBINA NEGRA CONECTOR</p>	 <p>18-61051 KIT TORNILLOS (4 por PACK) Para: Mercuriser V6 & V8 Thunderbolt Tapa distribuidor</p>



CARACTERÍSTICAS

- Ajuste automático de la bobina y se ajusta para mantener el pico en todo el rango de evoluciones del motor.
- Total disponibilidad de energía entre 3.000 y 5.000 RPM.
- Encendido más regular(estable)
- Usar con 18-5472 "Flame Thrower II" bobina de alto rendimiento

18-5285
**KIT CONVERSIÓN ELEC-
TRÓNICO ALTO RENDIMIENTO**

Para: 4 Cilindros Delco Distribuidor



18-5286
**KIT CONVERSIÓN
ELECTRÓNICO ALTO
RENDIMIENTO**

Para: 6 Cilindros Delco Distribuidor



18-5288
**KIT CONVERSIÓN ELECTRÓNICO ALTO
RENDIMIENTO**

Para: Mayoría de distrib. Prestolite V-8 tapa fijada con clips



18-5289
KIT DE CONVERSIÓN

Para: Mayoría de distribuidores prestolite tapa fijada con tornillos



18-5290
**KIT CONVERSIÓN ELECTRÓNICO
ALTO RENDIMIENTO**

Para: Mayoría de Mallory YL o YD 8 cil., rotación normal y contrarrotación.



CARACTERÍSTICAS

- Reemplaza platinos y condensador para un buen encendido
- Usa bobina tapa y rotor standard.
- Fácil de instalar, una pieza, 2-conexiones de cables.
- Con una tolerancia de 1/4° en el encendido 0 a 6000 RPM.
- Se pueden usar con bobina Flame Thrower 18-5466 y 18-5469.

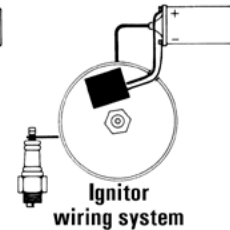

18-5294
KIT CONVERSIÓN ELECTRÓNICO

Para: 6 Cil. Delco Distribuidor



18-5295
KIT CONVERSIÓN ELECTRÓNICO

Para: Mayoría 4 Cil. Prestolite Distribuidores (Excepto IBM7026)
Para: Onan, Universal, Waukesha, Wisconsin



① 18-5296-2D



18-5296-2
KIT CONVERSIÓN ELECTRÓNICO

Para: Mayoría de Mallory YL o YD 8 cil., rotación normal y contrarrotación.



① 18-5297D



18-5297
KIT CONVERSIÓN ELECTRÓNICO

Para 4 Cil. GM



18-5298
KIT CONVERSIÓN ELECTRÓNICO

(con tapa fijada con clips) Para: Mayoría Prestolite V-8 Distribuidores



① 18-5299D



18-5299
KIT CONVERSIÓN ELECTRÓNICO

(con tapa fijada) Para: Mayoría Prestolite V-8 Distribuidores
Use con 18-5403 Rotor



APLICACIONES EMPIEZAN EN LA PÁGINA 40

① Referencias acabadas en "D" envasadas - Referencia normal no envasada



CARACTERÍSTICAS

- Distribuidores mejoran el encendido y mejoran las prestaciones.
- Los componentes de alta calidad utilizados garantizan una larga vida.
- Mejoran las prestaciones y la potencia.

Standard Rotation

CCW Rotation

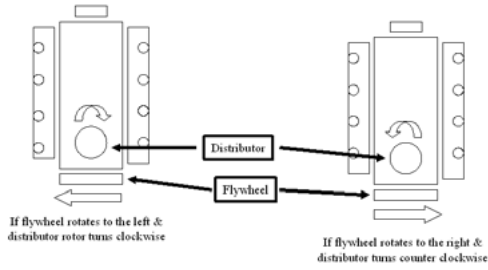

18-5481
DISTRIBUIDOR ELECTRÓNICO ALTO RENDIMIENTO
 Para: Ford V-8 351 Windsor
 Reemplaza tapa/rotor kit: 18-5266

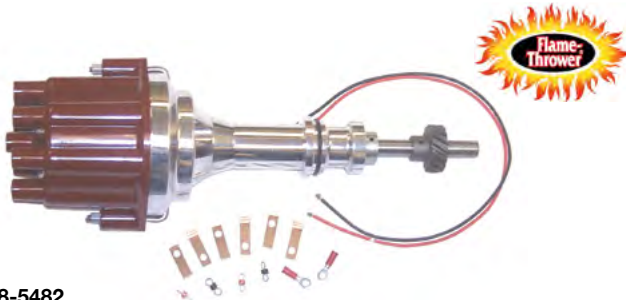

18-5482
DISTRIBUIDOR ELECTRÓNICO ALTO RENDIMIENTO
 Para: motores Ford V-8 351 Cleveland, 351M, 400, 429 y 460
 Reemplaza tapa/rotor kit: 18-5266



18-5483
DISTRIBUIDOR ELECTRÓNICO ALTO RENDIMIENTO
 Para: bloque motor Chevrolet marine pequeño y grande (altura de cubierta estándar)
 Reemplaza tapa/rotor kit: 18-5266

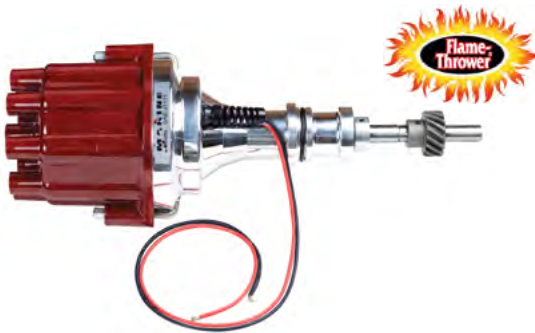

18-5477
DISTRIBUIDOR ELECTRÓNICO
 Para: motor Ford 302 V-8
 Reemplaza tapa/Rotor Kit 18-5266

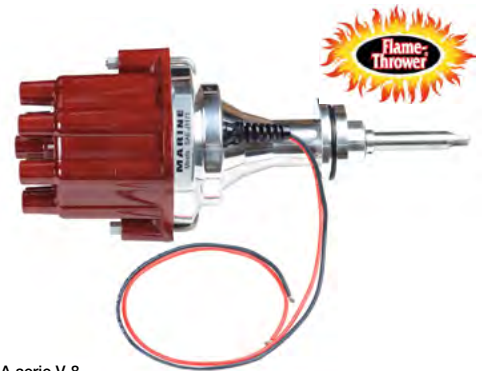

18-5478
DISTRIBUIDOR ELECTRÓNICO
 Para: motor Chrysler LA serie V-8
 Reemplaza tapa/Rotor Kit 18-5266



18-5479
DISTRIBUIDOR ELECTRÓNICO
 Para: motor GM V-8 rotación reverso
 Reemplaza tapa/Rotor Kit 18-5266



18-5480
KIT DE CONVERSIÓN DE ENCENDIDO COMPLETO
 Para: GM SB & BB con altura cubierta estándar
 —CONTIENE—

Ref #	Descripción
18-5472	Bobina
18-8803-2	Juego cables
18-5483	Distribuidor

18-26002-1
KIT SISTEMA ENCENDIDO
Para: motores GM 4.3L/262 CID



18-5470
THUNDERBOLT IV V-8 DISTRIBUIDOR
Reemplaza: 805185A36
Para: motores GM V-8
Kit encendido 18-5273



18-5471
THUNDERBOLT IV V-6 DISTRIBUIDOR
Reemplaza: 805185A37
GM V-6 motor
Kit encendido 18-5274



18-5350
DISTRIBUIDOR
Reemplaza: 888751A03, 888751A02, 888751A1
Para: Vortec V-6 4.3L MPI (2002-SUP) (S/N OM300000 y SUP)



18-5351
DISTRIBUIDOR
Reemplaza: 884794A02, 884794A1
Para: Vortec V-8 2001 y sup 5.0L/ 5.7L/ 6.2L MPI motores (S/N OM300000 y sup)



18-5475
DISTRIBUIDOR
Reemplaza: 817377, 817377T
PARA: 4 CIL GM CON DELCO EST ENCENDIDO
KIT ENCENDIDO 18-5280



18-5476
DISTRIBUIDOR
Reemplaza: 807964A1, 907964A1
Para: Motores GM V-6 con Delco EST encendido HEI
Kit encendido 18-5278



18-5484-1
DISTRIBUIDOR ELECTRÓNICO
ROTACION CONVENCIONAL
Reemplaza: 805222A1
Último modelo HEI

Para V8 — 262-454 & 502 excepto
384/ 409 y bloques grandes
• Diseñado como reemplazo de enchufe
para distribuidores de combustible con
sistema de inyección tipo GM.

— CONTIENE —
Descripción Ref #
Tapa distribuidor 18-5354
Rotor 18-5405

Kit encendido 18-5281



18-26111-1
DISTRIBUIDOR
Reemplaza: Mallory YL648AV
Para: Mercruiser 3.7L L4/LH



18-5486-2
DISTRIBUIDOR ELECTRÓNICO
Rotación convencional
Para Chevrolet L4, 153 & 181 CID

— CONTIENE —
Ref # Descripción
18-5397 Tapa distribuidor
18-5488 Modulo
18-5404-1 Rotor



18-5487-2

DISTRIBUIDOR ELECTRÓNICO

Reemplaza: 9-26309, Mallory YLM676AV

Rotación convencional

Para GM L6, 194, 230, 250, 292 CID

—CONTIENE—

Ref #	Descripción
18-5488	Modulo
18-5404-1	Rotor



18-5489-2

DISTRIBUIDOR ELECTRÓNICO

Rotación convencional

Para Ford V8 351W CID

—CONTIENE—

Ref #	Descripción
18-5376	Tapa distribuidor
18-5488	Modulo
18-5404-1	Rotor



18-5494-2

DISTRIBUIDOR ELECTRÓNICO

Rotación convencional

Para Chevrolet todos V8 incluyen 482, 502, 540 CID (Excepto 348,409 & bloque grande para cubierta)

—CONTIENE—

Ref #	Descripción
18-5376	Tapa distribuidor
18-5488	Modulo
18-5404-1	Rotor



18-5495-2

DISTRIBUIDOR ELECTRÓNICO

Rotación convencional

Para Ford V8 302 CID

—CONTIENE—

Ref #	Descripción
18-5376	Tapa distribuidor
18-5488	Modulo
18-5404-1	Rotor



18-5496-2

DISTRIBUIDOR ELECTRÓNICO

Reemplaza: YLM567CV

Rotación convencional

Para: Ford V8 351C — 460 CID

—CONTIENE—

Ref #	Descripción
18-5376	Distribuidor tapa
18-5488	Modulo
18-5404-1	Rotor



18-5497-2

DISTRIBUIDOR ELECTRÓNICO

Reemplaza: YLM579AV

Rotación convencional

Para Chrysler V8 273,318 (67 & SUP) 340, 360 CID "LA"

—CONTIENE—

Ref #	Descripción
18-5376	Distribuidor tapa
18-5488	Modulo
18-5404-1	Rotor



18-5309-1

DISTRIBUIDOR

Contacto controlado (Rotación estándar)

Reemplaza: Mallory YL512CV

Para mayoría de motores Ford 302 CID V-8

Kit encendido 18-5251

—CONTIENE—

Ref #	Descripción
18-5314	Juego de contactos
18-5338	Condensador
18-5404-1	Rotor



18-5312-1

DISTRIBUIDOR (Contacto controlado)

Reemplaza: Mallory YL554CV

Para mayoría de motores Ford 351 CID V-8

Kit encendido 18-5251



18-5313-1

DISTRIBUIDOR

Contacto controlado (rotación estándar)

Reemplaza: 17177A1, 91823A3,

816148A1, 74905A3, 68521A4,

68521A3, 13447A1

Mallory YL624AV

Para mayoría de motores GM V-8 (pequeño & gran bloque) Mallory tapa alta

Kit encendido 18-5251

—CONTIENE—

Ref #	Descripción
18-5314	Juego de contactos
18-5338	Condensador
18-5404-1	Rotor



18-5315-1

DISTRIBUIDOR

Contacto controlado (Standard Rotation)

Reemplaza: 87581, 87581T, 62424,

58231, 52352, 33266, 195141

Mallory YL673AV

Para mayoría de motores GM 4 Cil (120 & 140 HP)

kit en encendido 18-5251

—CONTIENE—

Ref #	Descripción
18-5314	Juego de contactos
18-5338	Condensador
18-5404-1	Rotor





18-5498-2
DISTRIBUIDOR ELECTRÓNICO
Reemplaza: 9-26307; Mallory YLM624BV
Para GM V8, 482, 502, 540 CID (Excepto 348, 409 & bloque grande para cubierta) (Rotación reverso)



18-5316-1
DISTRIBUIDOR
Reemplaza: Mallory YL624BV
Para mayoría GM V8 (Rotación reverso)



18-5339-1
DISTRIBUIDOR
Reemplaza: 9-26103; Mallory YL566AV
Para GM V8 327



18-26110-1
DISTRIBUIDOR
Reemplaza: 9-26110; Mallory YL579AV
Para Chrysler V8, 273, 318 (1967 & Sup), motores 340 y 360 "LA"



18-26104-1
DISTRIBUIDOR
Reemplaza: 9-26104; Mallory YL567EV
Para Ford V8 351C



18-26112-1
DISTRIBUIDOR
Reemplaza: 9-26112; Mallory YL676AV
Para GM L6, 194, 230, 250, 292 CID (Rotación convencional)



18-5512
I/L 4 Delco EST kit conversión
Descripción: Convierte motores electrónicos de 4 cilindros
Incluye: Distribuidor, Bobina, cables encendido, y cableados



18-5513
V-6 DELCO EST KIT CONVERSIÓN
Descripción: Convierte 6 Cilindro motor electrónico GM
Incluye: Distribuidor, bobina, Cables encendido, y cableados



18-5514
V-8 DELCO EST KIT CONVERSIÓN
Descripción: Convierte 8 Cilindros motores electrónicos GM
Incluye: Distribuidor, bobina, cables encendido, y cableados



18-5518
I/L 4 Sierra Electrónico kit conversión distribuidor
Descripción: Convierte 4 Cilindros GM Motores electrónicos
Incluye: Distribuidor, bobina, cables encendido, y cableados



18-5519
I/L 6 Sierra Electrónico kit conversión distribuidor
Descripción: Convierte 6 Cilindros GM motores electrónicos
Incluye: Distribuidor, bobina, cables encendido, y cableados



18-5520
V-8 KIT DISTRIBUIDOR CONVERSIÓN ELECTRÓNICA
Descripción: Convierte 8 Cilindro motores electrónicos GM
Incluye: Distribuidor, bobina, cables encendido, y cableado

MODELO	Cil.	Tipo encendido	Año	Serie #	Kit encendido	Juego de contactos	Rotor	Dist. tapa	Bobina	Distribuidor	Cables de bujías
110	153/I4	⊙	1963-1966	1537370-2044033	18-5250 ★	18-5311	18-5418	18-5385	18-5433	18-5315-1	18-8800-1
					18-5268 ☐						
120	153/L4	⊙	1964-1986	1666601 - B531853	18-5250 ★	18-5311	18-5418	18-5385	18-5433	18-5315-1	18-8800-1
					18-5268 ☐						
2.5L	153/L4	⊙	1987-1989	B531854 - C853255	18-5250	18-5311			18-5433		
PRESTOLITE REPLC IGN	4 CIL	⊙	1963-1989	1537370 - C853255		18-5303	18-5403				
140	181/L4	⊙	1968-1986	2508261 - B450800	18-5250 ★	18-5311	18-5418	18-5385	18-5433	18-5315-1	18-8800-1
					18-5268 ☐						
3.0L	181/L4	⊙	1987-1989	B450801 - C856558	18-5250	18-5311			18-5433		
3.0L	181/L4	⊙	1990-1991	C856559 - D504541		18-5303	18-5403		18-5433		
3.0L	181/L4	⊕	1990-1991	C856559 - D504541							18-8811-1
3.0L	181/L4	⊙	1991-1994	D504542 - F603999				18-5361	18-5443		18-8833-1
3.0L	181/L4	⊙	1998-2010	L010042 - & SUP				18-5361	18-5443		18-8833-1
3.0L MPI	181/L4	⊙	2008-2010	A072812 - & SUP				18-5361	18-5443		18-8833-1
3.0LX	181/L4	⊕	1990-1991	C856559 - D504541							18-8811-1
3.0LX	181/L4	⊙	1991-1997	D504542 - K999999				18-5361	18-5443		18-8833-1
3.0L/ LX	L4		1990-1995	C856559 - F603999	18-5262	18-5303	18-5403		18-5433	18-5315-1	18-8800-1
3.0L/ LX	L4		1990-1995	C856559 - F603999							18-8811-1
3.0L/LX	L4		1996 & SUP	F604000 & SUP	18-5280		18-5406	18-5361	18-5443		18-8833-1
PRESTOLITE REPLC IGN	4 CYL	⊙	1968-1991	2508261 - D504541		18-5303	18-5403				
165	224/L4	⊙	1987	B434941 - B774251	18-5250	18-5311			18-5433		
170	224/L4	⊙	1985-1986	6916779 - B434940	18-5250	18-5311			18-5433		
180	224/L4	⊙	1987	B436391 - B775248	18-5250	18-5311			18-5433		
180	224/L4	⊙	1987-1989	B436391 - B775248		18-5303	18-5403		18-5433		
190	224/L4	⊙	1985-1986	6916779 - B436390	18-5250	18-5311			18-5433		
3.7L	224/L4	⊙	1988-1989	B774252 - & SUP	18-5250	18-5311			18-5433		
3.7LX	224/L4	⊙	1988-1989	B775249 - & SUP	18-5250	18-5311			18-5433		
3.7LX	224/L4	⊙	1988-1989	B775249 - & SUP		18-5303	18-5403		18-5433		
470	224/L4	⊙	1976-1984	4208730 - 6916778	18-5250 ★	18-5311	18-5418	18-5385	18-5433		18-8808-2
165, 170, 190 (224CID)	L4		1985-1989	6916779 & SUP	18-5250 ★	18-5311	18-5418	18-5385	18-5433		18-8808-2
					18-5268 ☐						
180LX	L4		1987-1989	B436391 & SUP	18-5250 ★	18-5311	18-5418	18-5385	18-5433		18-8808-2
					18-5268 ☐						
180LX	L4		1987-1989	B436391 & SUP	18-5262	18-5303	18-5403		18-5433		18-8808-2
160, 165(250cid)	L6		1967-1981	2048022-5813433	18-5250 ★	18-5311	18-5418	18-5386	18-5433		18-8809-1
					18-5269 ☐						
485	224/L4	⊙	1980-1982	5685394 - 6218036	18-5250	18-5311			18-5433		
488	224/L4	⊙	1983-1984	6170297 - 6916778	18-5250	18-5311			18-5433		
PRESTOLITE REPLC IGN	4 CIL	⊙	2010			18-5303	18-5403				
140	194/L6	⊙	1963	1538930 - 1725960	18-5250 ★	18-5311	18-5418	18-5386		18-5312-1	18-8809-1
					18-5269 ☐						
150	230/L6	⊙	1964-1966	1666495 - 2048046	18-5250 ★	18-5311	18-5418	18-5386			18-8809-1
					18-5269 ☐						
160	250/L6	⊙	1967-1970	2048022 - 2771483	18-5250	18-5311		18-5386	18-5433		
165	250/L6	⊙	1971-1981	2771484 - 5813433	18-5250	18-5311		18-5386	18-5433		
200	292/L6	⊙	1969	2453769 - 2712072	18-5250 ★	18-5311	18-5418	18-5386	18-5433	18-5487-2	18-8809-1
					18-5269 ☐						
PRESTOLITE REPLC IGN	6 CYL	⊙	2010			18-5303	18-5403	18-5353	18-5433		
185 (4 bbl)	229/V-6	⊙	1983-1984	6330183 - 6919655	18-5262 ★	18-5303	18-5403	18-5353	18-5433		18-8801-1
					18-5276 ☐						
175	262/V-6	⊙	1987	B527955 - B773242			18-5432	18-5396	18-5438		
175, 185, 4.3	262/V-6		1985-1993	6919656 - F000877	18-5274		18-5432	18-5396	18-5438		18-8810-1
185 (2bbl)	262/V-6	⊙	1985-1987	6919656 - B527954			18-5432	18-5396	18-5438		

- ⊙ Mallory encendido
- ⊙ Prestolite
- ⊙ Autolite
- ⊙ Mercury encendido
- ⊙ Holley
- ⊙ Thunderbolt IV

- ⊕ con tornillo bajo la tapa
- ⊙ Delco
- ⊙ Electronic dist. (rotación std) excluyendo thunderbolt encendido
- ⊙ Delco EST
- ⊕ Sistema digital Delco
- ★ Sin tapa dist

- ☐ Con tapa dist
- ☐ Mercury HEI
- ☐ Delco HEI
- ⚡ Thunderbolt V
- ▼ Prestolite con clip bajo la tapa distribuidor
- ⊕ Controlador contacto dist. (Rotación std) excl. Thunderbolt enc.

MODELO	Cil.	Tipo encendido	Año	Serie #	Kit encendido	Juego de contactos	Rotor	Dist. tapa	Bobina	Distribuidor	Cables de bujías
205	262/V-6	⊕	1985-1987	A331455 - B775129			18-5432	18-5396	18-5438		
205, 4.3LX 4bbl	262/V-6		1985-19996	A331455 - F802999	18-5274		18-5432	18-5396	18-5438		18-8810-1
262 TBI (GEN +)	262/V-6	⊕	1996-1997	F803800 - K999999					18-5443		18-8835-1
4.3L (2bbl)	262/V-6	⊕	1988-1996	B773243 - F802999			18-5432	18-5396	18-5438		
4.3L (2bbl) (GEN +)	262/V-6	⊕	1998-2010	L010044 & SUP			18-5432	18-5396			
4.3L EFI (GEN +) (TBI)	262/V-6	⊕	1998	L012009 - L359999					18-5438		18-8835-1
4.3L EFI (GEN +) (TBI)	262/V-6	⊕	1999-2001	L360000 - M299999			18-5432	18-5396	18-5438		
4.3L MPI	262/V-6	⊕	2002-2010	M300000 & SUP	18-5246		18-5245	18-5243	18-5465	18-5350	18-8829-1
4.3LH (GEN +) (4bbl)	262/V-6	⊕	1998-2002	L010044 - M614999			18-5432	18-5396	18-5438		
4.3LX (4bbl)	262/V-6	⊕	1988-1996	B775130 - F802999			18-5432	18-5396	18-5438		
4.3LX (GEN +) (2bbl)	262/V-6	⊕	1996-1997	F803000 - K999999			18-5432	18-5396	18-5438		
4.3L/LH/LX/LXH	V6		1996-2001	F803000 & SUP	18-5274		18-5432	18-5396	18-5438		18-8810-1
Alpha(Gen+)											
4.3L/LH/LX/LXH	V6		1996-2001	F803000 & SUP	18-5274		18-5432	18-5396	18-5438		18-8810-1
Bravo(Gen+)											
4.3L EFI,262	V6		1996-1998	F803000 - L359999	18-5278		18-5408	18-5362	18-5443		18-8810-1
Mag(TBI)(Gen+)											
4.3L EFI(TBI)	V6		1996 & sup	L012009 - L359999	18-5278		18-5408	18-5362	18-5443	18-5476	18-8835-1
(Gen+)				L360000 & SUP	18-5274		18-5432	18-5396	18-5438		18-8835-1
4.3L EFI(TBI)	V6		1999-2001	L360000 & SUP	18-5274		18-5432	18-5396	18-5438		18-8810-1
215 MCM & MIE (FORD)	302/V-8	⊕	1970-1972	2781153 - 3563181	18-5253 *	18-5318	18-5402	18-5389	18-5433	18-5495-2 ⊕	18-8803-2
					18-5267 ☐					18-5309-1 ⊕	
215 MCM & MIE (FORD)	302/V-8	⊕	1970-1972	2781153 - 3563181	18-5251 *	18-5314	18-5404-1	18-5376	18-5433	18-5495-2 ⊕	18-8803-2
					18-5271 ☐					18-5309-1 ⊕	
225 MCM & MIE (FORD)	302/V-8	⊕	1973-1974	3385721 - 4166999	18-5253 *	18-5318	18-5420	18-5389	18-5433	18-5495-2 ⊕	18-8803-2
Ford(302cid)					18-5267 ☐					18-5309-1 ⊕	
225 MCM & MIE (FORD)	302/V-8	⊕	1973-1974	3385721 - 4166999	18-5251 *	18-5314	18-5404-1	18-5376	18-5433	18-5495-2 ⊕	18-8803-2
					18-5271 ☐					18-5309-1 ⊕	
225 MCM & MIE (FORD)	302/V-8	⊕	1973-1974	3385721 - 4166999	18-5254 *	18-5317	18-5420	18-5389	18-5433	18-5495-2 ⊕	18-8803-2
					18-5267 ☐					18-5309-1 ⊕	
888 (FORD)	302/V-8	⊕	1971-1977	3108723 - 4887829	18-5254	18-5317	18-5420	18-5389	18-5433	18-5495-2 ⊕	18-8803-2
										18-5309-1 ⊕	
888 (FORD)	302/V-8	⊕	1971-1977	3108723 - 4887829	18-5253	18-5318	18-5420	18-5389	18-5433	18-5495-2 ⊕	18-8803-2
888 (FORD)	302/V-8	⊕	1971-1977	3108723 - 4887829	18-5258 *	18-5303	18-5407	18-5369	18-5433	18-5495-2 ⊕	
					18-5277 ☐					18-5309-1 ⊕	18-8803-2
888 (FORD)	302/V-8	⊕	1971-1977	3108723 - 4887829	18-5251 *	18-5314	18-5404-1	18-5376	18-5433	18-5495-2 ⊕	
					18-5271 ☐					18-5309-1 ⊕	18-8803-2
190 (GM 283)	283/V-8	⊕	1963-1964	1564539 - 1730903	18-5252	18-5310	18-5417	18-5384	18-5438	18-5498-1 ⊕	
										18-5494-2 ⊕	
										18-5313-1 ⊕	
198 MIE	305/V-8	⊕	1977	4776402 - 4931099		18-5314	18-5404-1		18-5433		
200 (5.0L)	305/V-8	⊕	1985-1995	6899058 - F600999			18-5431	18-5395	18-5438		
228	305/V-8	⊕	1977-1982	4765100 - 6218461		18-5314	18-5401-1		18-5433		
228	305/V-8	⊕	1982-1984	6218462 - 6899268			18-5431	18-5395	18-5438		
228 MIE	305/V-8	⊕	1977-1980	4765100 - 5907057		18-5314	18-5401-1		18-5433		
228 MCM & MIE	305/V-8		1977-1984	4765100 - 6218461	18-5251 *	18-5314	18-5404-1	18-5376	18-5433		18-8803-2
					18-5271 ☐					18-5498-1 ⊕	
228	305/V-8		1985-1986	6218462 - 6899268	18-5273		18-5431	18-5395	18-5438	18-5494-2 ⊕	18-8804-1
										18-5498-1 ⊕	
230, 5.0L/LX MIE	305/V-8		1981-1995	5907058 - F600999	18-5273		18-5431	18-5395	18-5438	18-5494-2 ⊕	18-8804-1
										18-5498-1 ⊕	
198, 898 MCM &	305/V-8		1977-1982	4776402 - 6218461	18-5251 *	18-5314	18-5404-1	18-5376	18-5433	18-5494-2 ⊕	18-8803-2
					18-5271 ☐					18-5498-1 ⊕	
230	305/V-8	⊕	1985-1987	6899269 - MB773739			18-5431	18-5395	18-5438		

- ⊕ Mallory encendido
- ⊕ Prestolite
- ⊕ Autolite
- ⊕ Mercury encendido
- ⊕ Holley
- ⊕ Thunderbolt IV
- ⊕ Con tornillo bajo la tapa
- ⊕ Delco
- ⊕ Dist. electrónico (rotación std) excluye Thunderbolt encendido
- ⊕ Delco EST
- ⊕ Sistema digital Delco
- ★ Sin tapa dist
- ☐ Con tapa dist
- ⬅ Mercury HEI
- ⊕ Delco HEI
- ⬆ Thunderbolt V
- ⬇ Prestolite con clip bajo la tapa distribuidor
- ⊕ Controlador de contacto dist. (Std. Rotation) excl. Thunderbolt enc.

MODELO	Cil.	Tipo encendido	Año	Serie #	Kit encendido	Juego de contactos	Rotor	Dist. tapa	Bobina	Distribuidor	Cables de bujías
230 MIE	305/V-8	⊙	1981-1987	5907058 - B788151			18-5431	18-5395	18-5438		
5.0L (GEN +)	305/V-8	⚡	1998-2010	L015751 & SUP			18-5431	18-5395	18-5438		
5.0L EFI (Gen+)	305/V-8	⊙	1998	L012052 - L331630	18-5281		18-5405	18-5354	18-5442	18-5494-2 ⊙	18-8836-1
										18-5498-1 ⊙	
5.0L EFI (GEN +)	305/V-8	⊙	1998	L331651 - L339999					18-5442		
5.0L EFI (GEN +)	305/V-8	⊙	1999	L331631 - L331650			18-5431		18-5438		
5.0L MPI	305/V-8	⊙	2002-2010	M300000 & SUP							18-8828-1
5.0L MIE	305/V-8	⊙	1988	B788152 - C396832			18-5431	18-5395	18-5438		
5.0LX	305/V-8	⊙	1988-1995	B773740 - F600999			18-5431	18-5395			
898	305/V-8	⊙	1977-1982	4762210 - 621461		18-5314	18-5404-1		18-5433		
898	305/V-8	⊙	1983-1984	6218462 - 6899057			18-5431	18-5395	18-5438		
350MAG MPI	V8		1998-2001	L302200 & SUP	18-5273		18-5431	18-5395	18-5438	18-5494-2	
(Gen+) &										18-5498-1	
MIE(Gen+)											
350 MAG MPI	V8		2001-2004	M300000 & SUP	18-5247		18-5245	18-5244	18-5465	18-5351	
350 MAG MPI					18-5247		18-5245	18-5244			
HORIZON											
350 MAG	V8		1999-2001	L304700 & SUP	18-5273		18-5431	18-5395	18-5438	18-5494-2	
HORIZON MIE										18-5498-1	
350 MAG HORIZON	V8		2001-2004	M300000 & Sup	18-5247		18-5245	18-5244	18-5465	18-5351	
MIE											
350MAG MPI	V8		1999-2001	L304600 & Sup	18-5273		18-5431	18-5395	18-5438	18-5494-2	
SKI(Gen+)										18-5498-1	
350MAG SKI	V8		1991-1996	D505450 - K040399	18-5273		18-5431	18-5395	18-5438	18-5494-2	
										18-5498-1	
350MAG SKI	V8		1991-1996	D505450 - K040399	18-5273		18-5431	18-5395	18-5438	18-5494-2	
										18-5498-1	
350MAG SKI	V8		1991-1997	D505450 - K999999	18-5273		18-5431	18-5395	18-5438	18-5494-2	
										18-5498-1	
225 (GM)	327/V-8	⊙	1963-1969	1539620 - 2694014	18-5252 ★	18-5310	18-5417	18-5384	18-5433	18-5494-2 ⊙	18-8803-2
					18-5270 ☞					18-5498-1 ⊙	
										18-5313-1 Ⓢ	
225 MIE (GM)	327/V-8	⚡	1968	2278647 - 2694014	18-5282		18-5420	18-5389		18-5494-2 ⊙	18-8803-2
										18-5498-1 ⊙	
250 MCM & MIE	327/V-8	⚡	1968-1969	2314301 - 2639854	18-5282		18-5420	18-5389		18-5494-2 ⊙	18-8803-2
										18-5498-1 ⊙	
250	350/V-8	⊙	1977	4768000 - 4908849	18-5251 ★	18-5314	18-5404-1	18-5376	18-5433	18-5494-2 ⊙	18-8803-2
					18-5271					18-5498-1 ⊙	
250 MCM & MIE (GM)	350/V-8	⊙	1975-1976	3258728 - 4521254		18-5317	18-5420	18-5389	18-5433		
255 MCM (GM)	350/V-8	⊙	1976	4498701 - 4767999		18-5314	18-5404-1		18-5433		
255 MIE	350/V-8	⊙	1976-1980	4498701 - 5907057		18-5314	18-5404-1				
260	350/V-8	⊙	1978-1982	4908850 - 6218461		18-5314	18-5404-1		18-5433		
270 MCM & MIE	350/V-8	⚡	1969-1972	2851074 - 3385720	18-5282		18-5420	18-5389	332- 4895A 8	18-5494-2 ⊙	18-8803-2
										18-5498-1 ⊙	
280 TRS	350/V-8	⊙	1975	4176250 - 4499390		18-5317	18-5420	18-5389	18-5433		
280 TRS	350/V-8	⊙	1976	4499391 - 4770199	18-5251 ★	18-5314	18-5404-1	18-5376	18-5433	18-5494-2 ⊙	18-8803-2
					18-5271 ☞					18-5498-1 ⊙	
										18-5313-1 Ⓢ	
300	350/V-8	⊙	1985-1986	6668677 - B430367			18-5431	18-5395	18-5438		
320 EFI	350/V-8	⊙	1987-1989	A543604 - C622418			18-5431	18-5395	18-5438		
350 MAG ALPHA	350/V-8	⊙, ⚡	1986-1997	A635178 - K999999			18-5431	18-5395	18-5438		
350 MAGALPHA EFI (GEN +)	350/V-8	⊙	1996-1997	F800300 - K999999	18-5281		18-5405	18-5354	18-5442	18-5494-2 ⊙	18-8836-1
350 MAG BRAVO MPI	350/V-8	⊙	1995-1997	F415189 - K999999				18-5354	18-5443	18-5498-1 ⊙	18-8836-1
350 MAG EFI SKI	350/V-8	⊙	1994-1997	F215561 - K999999				18-5354	18-5443		18-8832-1

- ⊙ Mallory Ignition
- ⊙ Prestolite
- ⊙ Autolite
- ⊙ Mercury Ignition
- ⊙ Holley
- ⊙ Thunderbolt IV

- ⊙ Con tornillo bajo la tapa
- ⊙ Delco
- ⊙ Dist. electrónico (rotación std) excluye Thunderbolt encendido
- ⊙ Delco EST
- ⊙ Sistema digital Delco
- ★ Sin tapa dist

- ☞ Con tapa dist
- ⚡ Mercury HEI
- ⊙ Delco HEI
- ⚡ Thunderbolt V
- ▼ Prestolite con clip bajo la tapa distribuidor
- Ⓢ Controlador contacto dist. (Rotación std) excl. Thunderbolt enc.

MODELO	Cil.	Tipo encendido	Año	Serie #	Kit encendido	Juego de contactos	Rotor	Dist. tapa	Buñía	Distribuidor	Cables de bujías
350 MAG MPI (GEN +)	350/V-8	ESP	1998	L010019 - L325962	18-5281		18-5405	18-5354	18-5442	18-5494-2 ②	18-8832-1
										18-5498-1 ②	
350 MAG MPI (GEN +)	350/V-8	☛	1999-2001	L325953 - M999999			18-5431	18-5395	18-5438		
350 MAG MPI	350/V-8	ESP	2002-2010	M300000 & SUP				18-5244			18-8828-1
350 MAG MPI HORIZON	350/V-8	ESP	2002-2007	M300000 - A299999				18-5244			
350 MAG MPI HORIZON MIE	350/V-8	☛	1999-2001	L304700 - M299999			18-5431	18-5395	18-5438		
350 MAG MPI HORIZON MIE	350/V-8	ESP	2002-2007	M300000 - A089999				18-5244			
350 MAG MPI MIE (GEN +)	350/V-8	ESP	1998	L002008 - L302199	18-5281		18-5405	18-5354	18-5443	18-5494-2 ②	18-8832-1
										18-5498-1 ②	
350 MAG MPI MIE (GEN +)	350/V-8	☛	1998-2001	L302200 - M299999	18-5273		18-5431	18-5395	18-5438		18-8834-1
350 MAG MPI MIE	350/V-8	ESP	2002-2007	M300000 - A089999				18-5244			18-8828-1
350 MAG MPI SKI	350/V-8	ESP	1995-1998	F350583 - L304599	18-5281		18-5405	18-5354	18-5443	18-5494-2 ②	18-8836-1
										18-5498-1 ②	
350 MAG MPI SKI (GEN +)	350/V-8	☛	1999-2001	L304600 - M299999			18-5431	18-5395	18-5438		
350 MAG MPI SKI	350/V-8	ESP	2002-2007	M300000 - A089999				18-5244			18-8828-1
350 MAG SKI	350/V-8	②, ♣	1991-1997	D505450 - K999999			18-5431	18-5395	392-805570A 2		
350MAG BRAVO	V8		1995-1998	F415189 - L325952	18-5281		18-5405	18-5354	18-5443	18-5494-2 ②	18-8836-1
MPI &(Gen+)										18-5498-1 ②	
350MAG EFI SKI	V8		1996-1997	F820707 - K999999	18-5281		18-5405	18-5354	18-5443	18-5494-2 ②	18-8832-1
&(Gen+)										18-5498-1 ②	
5.0L Alpha &	V8		1998-2001	L015751 & sup	18-5273		18-5431	18-5395	18-5438	18-5494-2 ②	18-8821-1
Bravo(Gen+)										18-5498-1 ②	
5.0L EFI (Gen +)	V8		1999-2001	L331631 & sup	18-5273		18-5431	18-5395	18-5438	18-5494-2 ②	18-8834-1
										18-5498-1 ②	
5.0L MCM/MIE MPI,	V8		2001 & sup	M300000 & SUP	18-5247		18-5245	18-5244	18-5465	18-5351	18-8828-1
198, 898, 5.0L GM	V8		1983-1984	6218462 - 6899057	18-5273		18-5431	18-5395	18-5438	18-5494-2	18-8804-1
(305cid)										18-5498-1	
200, 5.0L GM	V8		1985-1995	6218462 - F600999	18-5273		18-5431	18-5395	18-5438	18-5494-2	18-8804-1
(305cid)										18-5498-1	18-8834-1
200, 5.0L GM	V8		1987-1995	B525982 - F600999	18-5273		18-5431	18-5395	18-5438	18-5494-2	
(305cid)										18-5498-1	
5.7L	350/V-8	②, ♣	1988-2010	6218462 & SUP			18-5431	18-5395			18-8828-1
5.7L EFI	350/V-8	ESP	1995-1997	F225560 - K999999				18-5354			18-8828-1
5.7L EFI (GEN +)	350/V-8	ESP	1998	L010035 - L325976				18-5354	18-5442		
5.7L EFI (GEN +)	350/V-8	ESP	1998	L326000 - L331598				18-5354	18-5442		
5.7L EFI (GEN +)	350/V-8	ESP	1998	L336000 - L339999				18-5354	18-5442		
5.7L EFI (GEN +)	350/V-8	☛	1999	L325977 - L325999			18-5431	18-5395	18-5438		
5.7L EFI (GEN +)	350/V-8	☛	1999	L331599 - L331991			18-5431	18-5395	18-5438		
5.7L EFI (GEN +)	350/V-8	☛	1999	L335716 - L335999			18-5431	18-5395	18-5438		
5.7L EFI (GEN +)	350/V-8	☛	1999-2001	L340000 - M299999			18-5431	18-5395	18-5438		
5.7L EFI MIE (GEN +)	350/V-8	☛	1997	K040300 - K999999					18-5442		
5.7L MIE	350/V-8	②, ♣	1988-2010	B788152 & SUP			18-5431	18-5395			
5.7L MPI HORIZON MIE	350/V-8	ESP	2008-2010	A090000 & SUP				18-5244			18-8821-1
5.7L MPI MIE	350/V-8	ESP	2008-2010	A090000 & SUP				18-5244			
5.7L MPI SKI	350/V-8	ESP	2008-2010	A090000 & SUP				18-5244	18-5433		18-8821-1
5.7L SKI	350/V-8	②	1985-1995	A338553 - F775199	18-5251 ★	18-5314	18-5404-1	18-5376	18-5433	18-5494-2 ②	18-8802-1
					18-5271 ☞					18-5498-1 ②	
5.7L SKI	350/V-8	②	1985-1996	A338553 - F775199	18-5262 ★	18-5303	18-5403	18-5352	18-5433	18-5494-2 ②	18-8802-1
					18-5275 ☞					18-5498-1 ②	
5.7L SKI	350/V-8	②, ♣	1987-2010	B514627 & SUP			18-5431	18-5395			
5.7LX	350/V-8	♣	1995-1997	F601000 - K999999			18-5431	18-5395	18-5438		
5.7LX BRAVO EFI (GEN +)	350/V-8	ESP	1996-1997	F800300 - K999999				18-5354			
5.7LX EFI	350/V-8	ESP	1996-1997	F752400 - K999999	18-5281		18-5405	18-5354	18-5442	18-5494-2 ②	18-8836-1
										18-5498-1 ②	

- ① Mallory encendido
- ② Prestolite
- ③ Autolite
- ④ Mercury encendido
- ⑤ Holley
- ⑥ Thunderbolt IV

- ⑦ Con tornillo bajo la tapa
- ⑧ Delco
- ⑨ Dist. electrónico (rotación std) excluye Thunderbolt encendido
- ⑩ Delco EST
- ♣ Sistema digital Delco
- ★ Sin tapa dist

- ☞ Con tapa dist.
- ☛ Mercury HEI
- ESP Delco HEI
- ♣ Thunderbolt V
- ♥ Prestolite con clip bajo la tapa distribuidor
- ♣ Controlador contacto dist. (Rotación std.) excl. Thunderbolt enc.

MODELO	Cil.	Tipo encendido	Año	Serie #	Kit encendido	Juego de contactos	Rotor	Dist. tapa	Bobina	Distribuidor	Cables de bujías
5.7L MIE & SKI	V8		1998 & sup	L002003 & sup	18-5273 ★		18-5431	18-5395	18-5438		18-8830-1
5.7L EFI & (Gen+)	V8		1995-1998	F225560-L339999	18-5281 ☞		18-5405	18-5354	18-5442	18-5494-2 Ⓣ	18-8836-1
										18-5498-1 Ⓣ	
5.7L EFI & (Gen+)	V8		1999-2001	L325977 & SUP	18-5273		18-5431	18-5395	18-5438	18-5494-2 Ⓣ	18-8834-1
										18-5498-1 Ⓣ	
5.7L SKI	V8		1987-1997	B514627 - K999999	18-5273		18-5431	18-5395	18-5438	18-5494-2 Ⓣ	18-8821-1
										18-5498-1 Ⓣ	
5.7L SKI	V8		1987-1995	B514627 - F775199	18-5273		18-5431	18-5395	18-5433	18-5494-2 Ⓣ	18-8821-1
										18-5498-1 Ⓣ	
5.7L SKI	V8		1998-2001	L002005 & sup	18-5273		18-5431	18-5395	18-5438	18-5494-2 Ⓣ	18-8821-1
										18-5498-1 Ⓣ	
260, 350MAG	V8		1987-1995	B525982 - F600999	18-5273		18-5431	18-5395	18-5438	18-5494-2	18-8804-1
5.7L SKI/ ALPHA/										18-5498-1	
BRAVO(350cid)											
260, 350MAG,	V8		1987-1995	B525982 - F600999	18-5273		18-5431	18-5395	18-5438	18-5494-2	18-8821-1
5.7L ALPHA/										18-5498-1	
BRAVO(350cid)											
350MAG, 5.7L/	V8		1994-2001	F353525 & SUP	18-5273		18-5431	18-5395	18-5438	18-5494-2	18-8821-1
LX ALPHA &										18-5498-1	
BLACK SCORPION SKI (GEN +)	350/V-8	☞	1996-2003	F800000 - M391599				18-5354	18-5443		18-8832-1
BLACK SCORPION SKI (GEN +)	350/V-8	☞	2003-2007	M391600 - W698432				18-5395			
SCORPION 350	350/V-8	☞	2008-2010	W698433 & SUP				18-5395			
BLACK SCORPION	V8		1996	F800000 - K040000	18-5281		18-5405	18-5354	18-5443	18-5494-2	18-8832-1
SKI(Gen+) (350cid)										18-5498-1	
BLACK SCORPION	V8		1997-1998	K040001 - L005600	18-5281		18-5405	18-5354	18-5443	18-5494-2	18-8824-1
SKI(Gen+) (350cid)										18-5498-1	
BLACK SCORPION	V8		1998-2002	L005601 - M391599	18-5281		18-5405	18-5354	18-5443	18-5494-2	18-8822-1
SKI(Gen+) (350cid)										18-5498-1	
233 MCM & MIE (FORD)	351/V-8	Ⓣ	1975-1977	4173000 - 4902304	18-5260 ★	18-5303	18-5409	18-5352	18-5433	18-5489-2 Ⓣ	18-8803-2
					18-5275 ☞					18-5312-1 Ⓢ	
233 MCM & MIE (FORD)	351/V-8	▼	1975-1977	4173000 - 4902304	18-5258 ★	18-5303	18-5407	18-5369	18-5433	18-5489-2 Ⓣ	18-8803-2
					18-5277 ☞					18-5312-1 Ⓢ	
233 MCM & MIE (FORD)	351/V-8	Ⓣ	1975-1977	4173000 - 4902304	18-5254	18-5317	18-5420	18-5389	18-5433	18-5489-2 Ⓣ	18-8803-2
										18-5312-1 Ⓢ	
255 MCM & MIE	351/V-8		1973-1974	3385721 - 4166999	18-5254	18-5317	18-5420	18-5389	18-5433	18-5489-2	18-8803-2
										18-5312-1	
255 MCM & MIE	351/V-8		1973-1974	3385721 - 4166999	18-5251	18-5314	18-5404-1	18-5376	18-5433	18-5489-2	18-8803-2
					18-5271					18-5312-1	
255 MIE & MCM (FORD)	351/V-8	Ⓣ	1973-1980	3258728 - 5907057		18-5314	18-5404-1		18-5433		
255 MIE & MCM (FORD)	351/V-8	Ⓣ	1973-1980	3258728 - 5907057			18-5420	18-5389	18-5433		
255, 260MCM &	V8		1975-1982	3258728 - 6218461	18-5251	18-5314	18-5404-1	18-5376	18-5433	18-5494-2 Ⓣ	18-8803-2
MIE(350cid)					18-5271					18-5498-1 Ⓣ	
										18-5313-1 Ⓢ	
255MCM & MIE	V8		1975-1980	4498701 - 5907057	18-5254	18-5317	18-5420	18-5389	18-5433	18-5494-2 Ⓣ	18-8803-2
(350cid)										18-5498-1 Ⓣ	
										18-5313-1 Ⓢ	
260,350MAG,	V8		1982-1994	6218462 - F600999	18-5273		18-5431	18-5395	18-5438	18-5494-2 Ⓣ	18-8804-1
										18-5498-1 Ⓣ	
										18-5313-1 Ⓢ	
300, 320EFI	350/V-8		1985-1989	A543604 - C622418	18-5273		18-5431	18-5395	18-5438	18-5494-2 Ⓣ	18-8804-1
										18-5498-1 Ⓣ	
377 MAG	377/V-8	☞	2008-2010	A300000 & SUP				18-5244			
377 SCORPION MCM	377/V-8	☞	1999-2005	L416146 - M907201	18-5281		18-5405	18-5354	18-5443	18-5494-2 Ⓣ	
										18-5498-1 Ⓣ	

- Ⓣ Mallory encendido
- Ⓣ Prestolite
- Ⓣ Autolite
- Ⓣ Mercury encendido
- Ⓣ Holley
- Ⓣ Thunderbolt IV

- ☞ Con tornillos bajo la tapa
- Ⓣ Delco
- Ⓣ Dist. electrónico (Rotación std) excluye Thunderbolt encendido
- Ⓣ Delco EST
- Ⓢ Sistema digital Delco
- ★ Sin tapa dist.

- ☞ Con tapa dist.
- ☞ Mercury HEI
- ☞ Delco HEI
- Ⓢ Thunderbolt V
- ▼ Prestolite con clip bajo la tapa distribuidor
- Ⓢ Controlador contacto dist. (Std. Rotation) excl. Thunderbolt enc.

MODELO	Cil.	Tipo encendido	Año	Serie #	Kit encendido	Juego de contactos	Rotor	Dist. tapa	Bobina	Distribuidor	Cables de bujías
377 SCORPION SKI	377/V-8		1997-1998	K000656 - L00314	18-5281		18-5405	18-5354	18-5443	18-5494-2 Ⓣ	
										18-5498-1 Ⓣ	
MX 6.2L MPI	377/V-8	☛	2000-2001	L680003 - M299999	18-5273		18-5431	18-5395	18-5438	18-5494-2 Ⓣ	18-8834-1
										18-5498-1 Ⓣ	
MX 6.2L MPI (377CID)	377/V-8	Ⓢ	2002-2007	M300000 - A299999	18-5247		18-5245	18-5244			18-8828-1
MX 6.2L MPI	377/V-8		2001-2004	M300000 & SUP	18-5247		18-5245	18-5244	18-5465	18-5351	18-8828-1
MX 6.2L MPI HORIZON	377/V-8	Ⓢ	2002-2007	M300000 - A299999	18-5247		18-5245	18-5244	18-5465	18-5351	18-8828-1
MX 6.2L MPI HORIZON MIE	377/V-8	Ⓢ	2002-2010	M300000 & SUP	18-5247		18-5245	18-5244	18-5465	18-5351	18-8828-1
MX 6.2L MPI MIE	377/V-8	☛	2000-2001	L670000 - M299999			18-5431	18-5395	18-5438		
MX 6.2L MPI MIE	377/V-8	Ⓢ	2002-2010	M300000 - & SUP				18-5244			18-8828-1
MX 6.2L MPI SKI	377/V-8	Ⓢ	2002-2007	M317000 - A089999	18-5247		18-5245	18-5244			18-8828-1
MX 6.2L BLACK SCORPION SKI	377/V-8	Ⓢ	2001-2003	F800000 - M391599				18-5354			N/D
MX 6.2L BLACK SCORPION SKI	377/V-8	☛	2003-2007	M391600 - W698432				18-5395			
SCORPION 377	377/V-8	☛	2008-2010	W698433 & SUP				18-5395			
325 MCM & MIE	427/V-8	♣	1969-1974	2278747 & SUP	18-5282		18-5420	18-5389		18-5494-2 Ⓣ	18-8803-2
										18-5498-1 Ⓣ	
330 MCM & MIE	454/V-8	Ⓣ	1977-1981	4623115-6083144	18-5251 ★	18-5314	18-5404-1	18-5376	18-5433	18-5494-2 Ⓣ	18-8803-2
					18-5271 ☞					18-5498-1 Ⓣ	
										18-5313-1 Ⓣ	
330 MCM & MIE	454/V-8	♣	1977-1981	4623115-6083144	18-5282		18-5420	18-5389		18-5494-2 Ⓣ	18-8803-2
										18-5498-1 Ⓣ	
										18-5313-1 Ⓣ	
330	454/V-8	Ⓣ	1982-1987	6083145 - B816540			18-5431	18-5395	18-5438		
330, 340, 7.4L	454/V-8		1981-1992	5889914 - D715493	18-5273		18-5431	18-5395	18-5438	18-5494-2 Ⓣ	18-8804-1
MCM & MIE(454cid)										18-5498-1 Ⓣ	
340 MIE	454/V-8	Ⓣ	1981-1987	5889914 - B788365			18-5431	18-5395	18-5438		
350 MIE	454/V-8	♣	1974-1976	3780450 - 4623109	18-5282		18-5420	18-5389		18-5494-2 Ⓣ	18-8803-2
										18-5498-1 Ⓣ	
370 TRS	454/V-8	Ⓣ	1978-1985	4179554 - 6721527	18-5251 ★	18-5314	18-5404-1	18-5376	18-5433	18-5494-2 Ⓣ	18-8803-2
					18-5271 ☞					18-5498-1 Ⓣ	
										18-5313-1 Ⓣ	
370 TRS	454/V-8	Ⓣ	1978-1985	4883520 - 6721527	18-5254	18-5317	18-5420	18-5389	18-5433	18-5494-2 Ⓣ	18-8803-2
										18-5498-1 Ⓣ	
										18-5313-1 Ⓣ	
370 TRS	454/V-8	Ⓣ	1985-1987	6721528 - B714586	18-5273		18-5431	18-5395	18-5433	18-5494-2 Ⓣ	18-8804-1
										18-5498-1 Ⓣ	
400 TRS	454/V-8	Ⓣ	1980-1986	5668232 - B457644		18-5314	18-5404-1		18-5433		
400 TRS	454/V-8	Ⓣ	1980-1986	5668232 - B457644		18-5317		18-5389	18-5433		
420	454/V-8	Ⓣ	1987-1989	A398941 - B622418	18-5273		18-5431	18-5395	18-5438	18-5494-2 Ⓣ	18-8837-1
										18-5498-1 Ⓣ	
425	454/V-8	Ⓣ	1990-1993	B622419 - D937011			18-5431	18-5395	18-5438		18-1837-1
440 TRS	454/V-8	Ⓣ	1983-1986	6181070 - B485220		18-5314	18-5404-1		18-5433		
450	454/V-8	Ⓣ	1995-1996	F347100 - F347277	18-5273		18-5431	18-5395	18-5438	18-5494-2 Ⓣ	
										18-5498-1 Ⓣ	
454 MAG ALPHA	454/V-8	Ⓣ	1986-1997	A631894 - B785148	18-5273		18-5431	18-5395	18-5438	18-5494-2 Ⓣ	18-8804-1
										18-5498-1 Ⓣ	
454 MAG BRAVO	454/V-8	Ⓣ, ♣	1988-1997	B721206 - K999999			18-5431	18-5395	18-5438		
454 MAG EFI	454/V-8	Ⓢ	1994-1996	F115700 - F802349				18-5354	18-5443		18-8832-1
454 MAG MPI	454/V-8	Ⓢ	1996-1998	F802350 - L085009				18-5354	18-5443		18-8832-1
454 MAG MPI	454/V-8	Ⓢ	1998-2001	L085010 - M024999				18-5354	18-5443		18-8832-1
454 MAG MPI HORIZON MIE	454/V-8	Ⓢ	1998-2001	L002200 - L674000	18-5281		18-5405	18-5354	18-5443	18-5494-2 Ⓣ	
										18-5498-1 Ⓣ	
454-EFI, MAG MPI	454/V-8		1994-2001	F115700 & SUP	18-5281		18-5405	18-5354	18-5443	18-5494-2 Ⓣ	18-8832-1
HORIZON MIE										18-5498-1 Ⓣ	

- Ⓣ Mallory Encendido
- Ⓢ Prestolite
- Ⓢ Autolite
- Ⓢ Mercury encendido
- Ⓢ Holley
- Ⓢ Thunderbolt IV

- Ⓣ Con tornillo bajo la tapa
- Ⓢ Delco
- Ⓢ Dist. electrónico (Rotación std) excluye Thunderbolt encendido
- Ⓢ Delco EST
- ♣ Sistema digital Delco
- ★ Sin tapa dist.

- ☞ Con tapa dist
- ☛ Mercury HEI
- Ⓢ Delco HEI
- ♣ Thunderbolt V
- ♥ Prestolite con clip bajo la tapa distribuidor
- ♣ Controlador contacto dist. (Std. Rotation) excl. Thunderbolt enc.

MODELO	Cil.	Tipo encendido	Año	Serie #	Kit encendido	Juego de contactos	Rotor	Dist. tapa	Bobina	Distribuidor	Cables de bujías
454 MAG MPI	454/V-8		1999-2001	L086001 - L674000	18-5281		18-5405	18-5354	18-5443	18-5494-2 ②	18-8832-1
HORIZON MIE										18-5498-1 ②	
454 MAG MPI SKI	454/V-8	⊙	1995-1997	F215800 - K999999				18-5354	18-5443		18-8832-1
525 SC	454/V-8	⊙, ⚡	1991-1999	D456000 - L415623			18-5431	18-5395			
7.4L BRAVO	454/V-8	⊙, ⚡	1988-1997	B771113 - K999999			18-5431	18-5395			
7.4L MIE	454/V-8	⊙, ⚡	1988-1997	B788366 - K999999			18-5431	18-5395			
7.4L MPI (L29)	454/V-8	⊙	1998-2001	L010003 - M024330				18-5354	18-5443		18-8832-1
7.4L MPI MIE	454/V-8	⊙	1995-1997	F563052 - K999999				18-5354	18-5443		18-8832-1
7.4L MPI MIE (L29)	454/V-8	⊙	1998-2001	L002006 - L674613				18-5354	18-5443		18-8832-1
7.4L TBI MIE	454/V-8	⊙	1996-1997	F874815 - K999999				18-5354			N/D
7.4LX BRAVO EFI	454/V-8	⊙	1996-1997	F820000 - K999999				18-5354	18-5443		18-8832-1
7.4LX BRAVO MPI	454/V-8	⊙	1996-1997	F602010 - K999999				18-5354	18-5443		18-8832-1
390	482/V-8	⚡	1969-197070	2781129 - 2825059	18-5282		18-5420	18-5389			18-8803-2
460 TRS	482/V-8	⊙	1983-198686	6180970 - 6181046	18-5251	18-5314	18-5404-1	18-5376	18-5433	18-5494-2 ②	18-8803-2
										18-5498-1 ②	
										18-5313-1 ⚡	
460 TRS	482/V-8	⊙	1983-1986	6180970 - 6181046	18-5254	18-5317	18-5420	18-5389	18-5433	18-5494-2 ②	18-8803-2
										18-5498-1 ②	
										18-5313-1 ⚡	
465	V8		1992-1994	D763732 - F213244	18-5273		18-5431	18-5395	18-5438		18-8837-1
496 / 8.1L	V8		2000 & sup	M025000 & SUP			N/D				18-8838-1
500	502/V-8	⊙, ⚡	1994-1999	F213293 - L601036	18-5273		18-5431	18-5395	18-5438		18-8837-1
500 EFI	502/V-8	⊙	1998-2005	L001477 - M907127				18-5354	18-5443		
502 MAG	502/V-8	⊙	1990-1993	C878221 - F114528	18-5273		18-5431	18-5395	18-5438		18-8804-1
502 MAG EFI	502/V-8	⊙	1993-1996	D840650 - F802599				18-5354	18-5443		18-8832-1
502 MAG MPI	502/V-8	⊙	1996-1998	F802600 - L085000				18-5354	18-5443		18-8832-1
500(Gen+)	502/V-8		1999	L414639 - L601036	18-5273		18-5431	18-5395	18-5438		18-8837-1
500GM EFI	502/V-8		1998-2000	0L001477 & sup	18-5281		18-5405	18-5354	18-5443		
502 MAG MPI	502/V-8		1993-1998	D840650 - L085000	18-5281		18-5405	18-5354	18-5443		18-8832-1
502GM MAG	502/V-8		1998-2001	L085001 & sup	18-5281		18-5405	18-5354	18-5443		18-8832-1
8.2L GM MPI MIE	502/V-8		1996-2001	F819620 & sup	18-5281		18-5405	18-5354	18-5443		18-8832-1
8.2L GM MPI MIE	502/V-8		1990-1996	C878221 - F819619	18-5273		18-5431	18-5395	18-5438		18-8804-1
525 SC	502/V-8		1991-1995	0D456000-0F877734	18-5273		18-5431	18-5395	18-5438		18-8804-1
525 SC	502/V-8		1996-1999	0K000012 & sup	18-5273		18-5431	18-5395	18-5438		18-8837-1
575 SCi	502/V-8	⊙	2000-2005	L306696 - M950526				18-5354	18-5443		
575 SCi	502/V-8	⊙	2000-2005	L306696 & SUP	18-5281		18-5405	18-5354	18-5443		
600 SC	502/V-8	⊙, ⚡	1991-2000	D456489 - L301186			18-5431	18-5395	18-5438		
600 SC	502/V-8		1991-1993	D456489 - D763875	18-5273		18-5431	18-5395	18-5438		18-8837-1
600 SC	502/V-8		1993-2001	D763876 & SUP	18-5273		18-5431	18-5395	18-5438		18-8837-1
8.2L MIE	502/V-8	⊙, ⚡	1990-1996	C878221 - F819619			13524T 1	18-5395	18-5438		
8.2L MPI MIE	502/V-8	⊙	1996-1998	F819620 - L086012				18-5354	18-5443		
8.2L MPI MIE	502/V-8	⊙	1998-2001	L086013 - L674200				18-5354	18-5443		
500 BULLDOG	540/V-8	⊙, ⚡	1990-2001	C577003 - M050281	18-5273		18-5431	18-5395	18-5438		18-8837-1
575	540/V-8	⊙	1986-1992	A677429 - D763716			18-5431	18-5395	18-5438		
800 SC	572/V-8	⊙, ⚡	1993-1998	D763836 & UP	18-5273		18-5431	18-5395	18-5438		18-8837-1

- ⊙ Mallory encendido
- ⊙ Prestolite
- ⊙ Autolite
- ⊙ Mercury encendido
- ⊙ Holley
- ⊙ Thunderbolt IV
- ⊙ Con tornillos bajo la tapa
- ⊙ Delco
- ⊙ Electronic dist. (std rotation) excluye Thunderbolt encendido
- ⊙ Delco EST
- ⊙ Sistema digital Delco
- ★ Sin tapa dist.
- ⊙ Con tapa dist.
- ⊙ Mercury HEI
- ⊙ Delco HEI
- ⊙ Thunderbolt V
- ⊙ Prestolite con clip bajo la tapa distribuidor
- ⊙ Controlador contacto dist. (Rotación std.) excl. Thunderbolt enc.

PREMIUM MARINE CABLES ENCENDIDO

Los cables de encendido SierraMAGFORCE son "amigos de la electrónica" ya que gracias a su protección todos los dispositivos electrónicos están aislados durante la entrega máxima de voltaje.

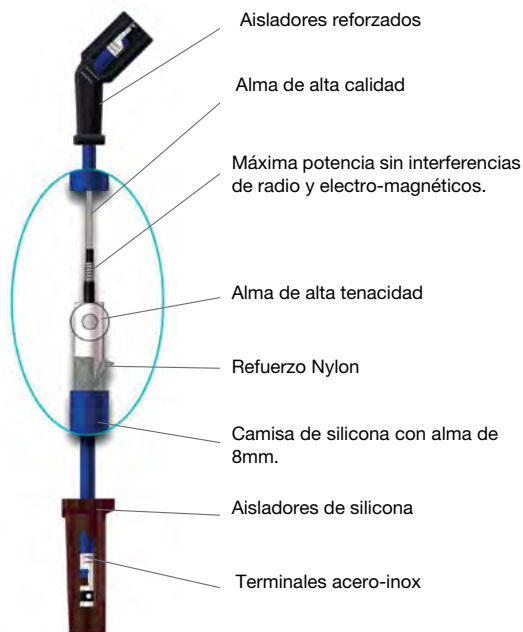

MERCURUISER MARINE APLICACIÓN CABLES ENCENDIDO

Modelo	Cil.	Distribuidor	Año inicial	Año final	Serie # inicial	Serie # final	Juego enchufe cable
110	4	Delco	1963	1966	1537370	2044033	18-8800-1
120	4	Delco	1964	1986	1666601	0B531853	18-8800-1
2.5L	4	Delco	1987	1989	0B531854	0C853255	18-8800-1
140	4	Delco	1968	1986	2508261	0B450800	18-8800-1
3.0L	4	Delco	1987	1989	0B450801	0C856558	18-8800-1
3.0L, LX	4	Prestolite	1990	1991	0C856559	0D504541	18-8800-1
3.0L, LX	4	Delco Digital	1990	1991	0C856559	0D504541	18-8811-1
3.0L	4	Delco EST	1991	& Sup	0D504542	& Sup	18-8833-1
3.0LX	4	Delco EST	1991	1997	0D504542	0K999999	18-8833-1
3.0L MPI	4	Delco EST	2012	& Sup	1A072812	& Sup	18-8833-1
165	4	Delco	1987	1987	0B434940	0B774251	18-8808-2
170	4	Delco	1985	1986	6916779	0B434940	18-8808-2
180	4	Prestolite	1987	1987	0B436391	0B775248	18-8800-1
190	4	Delco	1985	1986	6916779	0B436390	18-8808-2
3.7L	4	Delco	1988	1989	0B774252	& Sup	18-8808-2
3.7LX	4	Delco	1988	1989	0B775249	& Sup	18-8808-2
3.7LX	4	Prestolite	1988	1989	0B775249	& Sup	18-8800-1
470	4	Delco	1976	1984	4208370	6916778	18-8808-2
485	4	Delco	1980	1982	5685394	6218036	18-8808-2
488	4	Delco	1981	1984	6170297	6916778	18-8808-2
140	L6	Delco	1963	1963	1538930	1725960	18-8809-1
150	L6	Delco	1964	1966	1666495	2048046	18-8809-1
160	L6	Delco	1967	1969	2048022	2770031	18-8809-1
165	L6	Delco	1970	1981	2770032	5813433	18-8809-1
200	L6	Delco	1969	1969	2453769	2712072	18-8809-1
185	6	Prestolite	1983	1984	6330183	6919655	18-8801-1
175	6	Thunderbolt IV	1987	1987	0B527955	0B773242	18-8810-1

APLICACIONES CONTINUAN EN LA SIGUIENTE PÁGINA

MERCURUISER MARINE APLICACIÓN CABLES ENCENDIDO

Modelo	Cil.	Distribuidor	Año inicial	Año final	Serie # inicial	Serie # final	Juego enchufe cable
185	6	Thunderbolt IV	1985	1987	6919656	0B527954	18-8810-1
205	6	Thunderbolt IV	1985	1987	0A331445	0B775129	18-8810-1
262 Mag	6	Delco EST	1996	1997	0F803800	0K999999	18-8835-1
4.3L	6	Thunderbolt IV	1988	1996	0B773243	0F802999	18-8810-1
4.3L Alpha	6	Thunderbolt V	1998	& Sup	0L010044	& Sup	18-8810-1
4.3L Bravo	6	Thunderbolt V	1998	& Sup	0L010044	& Sup	18-8810-1
4.3L EFI	6	Delco EST	1998	1998	0L012009	0L359999	18-8835-1
4.3L EFI	6	Thunderbolt V	1999	2004	0L360000	& Sup	18-8810-1
4.3L MPI	6	Delco HVS	2001	& Sup	0M300000	& Sup	18-8829-1
4.3LH Alpha	6	Thunderbolt V	1998	2004	0L010044	& Sup	18-8810-1
4.3LH Bravo	6	Thunderbolt V	1998	2004	0L010044	& Sup	18-8810-1
4.3LX, LXH	6	Thunderbolt IV	1988	1997	0B775130	0K999999	18-8810-1
215 MCM & MIE (Ford)	8	Autolite/Mallory	1970	1972	2781153	3563181	18-8803-2
225 MCM & MIE (Ford)	8	Autolite/Mallory/Mercury	1973	1974	3385721	4166999	18-8803-2
888 (Ford)	8	Autolite/Mallory	1971	1977	3108723	4887829	18-8803-2
190 (GM)	8	Delco	1963	1964	1564539	1730903	18-8803-2
198 MIE	8	Mallory	1977	1977	4776402	4931099	18-8803-2
200	8	Thunderbolt IV	1985	1987	6899058	8774444	18-8821-1
228	8	Mallory	1977	1982	4765100	6218461	18-8803-2
228	8	Thunderbolt IV	1983	1984	6218462	6899268	18-8821-1
228 MIE	8	Mallory	1977	1980	4765100	5907057	18-8803-2
230	8	Thunderbolt IV	1985	1987	6899269	0B773739	18-8821-1
230 MIE (LH)	8	Thunderbolt IV	1981	1987	5907058	0B788151	18-8821-1
230 MIE (RH)	8	Thunderbolt IV	1981	1987	5907058	0B788151	18-8821-1
5.0L	8	Thunderbolt IV	1988	1995	0B774445	0F600999	18-8821-1
5.0L Alpha	8	Thunderbolt V	1998	& Sup	0L015751	& Sup	18-8821-1
5.0L Bravo	8	Thunderbolt V	1998	& Sup	0L015751	& Sup	18-8821-1
5.0L EFI	8	Delco EST	1998	1998	0L012052	0L339999	18-8822-1
5.0L MIE (LH)	8	Thunderbolt IV	1988	1988	0B788152	0C396832	18-8821-1
5.0L MIE (RH)	8	Thunderbolt IV	1988	1988	0B788152	0C396832	18-8821-1
5.0L MPI Alpha	8	Delco HVS	2001	& Sup	0M300000	& Sup	18-8828-1
5.0LX	8	Thunderbolt IV	1988	1995	0B773740	0F600999	18-8821-1
898	8	Mallory	1977	1982	4762210	6218461	18-8803-2
898	8	Thunderbolt IV	1983	1984	6218462	6899057	18-8821-1
225 (GM)	8	Delco	1963	1969	1539620	2694014	18-8803-2
225 MIE (GM)	8	Thunderbolt	1968	1968	2278647	2694014	18-8803-2
250 MCM & MIE	8	Thunderbolt	1968	1969	2314301	2639854	18-8803-2
250	8	Mallory	1977	1977	4768000	4908849	18-8803-2
255 MCM & MIE	8	Mallory	1975	1976	3258728	4501254	18-8803-2
255 MCM & MIE	8	Mercury	1976	1976	4498701	4767999	18-8803-2
255 MIE	8	Mercury	1977	1980	4768000	5907057	18-8803-2
260	8	Mallory	1978	1982	4908850	6218461	18-8803-2
260	8	Thunderbolt IV	1982	1987	6218462	0B773304	18-8821-1
260 MIE (LH)	8	Thunderbolt IV	1981	1986	5907058	0B788151	18-8821-1
260 MIE (RH)	8	Thunderbolt IV	1981	1986	5907058	0B788151	18-8821-1
270 MCM & MIE	8	Thunderbolt	1969	1972	2851074	3385720	18-8803-2
280 TRS	8	Mercury/Mallory	1975	1975	4176250	4499390	18-8803-2
300	8	Thunderbolt IV	1985	1986	6668677	0B430367	18-8821-1
320 EFI	8	Thunderbolt IV	1987	1989	0A543604	0C622418	18-8821-1
350 Mag Alpha	8	Thunderbolt IV	1986	1994	0A635178	0F353690	18-8821-1
350 Mag Alpha	8	Thunderbolt V	1995	1997	0F353691	0K999999	18-8821-1
350 Mag Alpha EFI	8	Delco EST	1996	1997	0F800300	0K999999	18-8822-1

APLICACIONES CONTINUAN EN LA SIGUIENTE PÁGINA

MERCUISER MARINE APLICACIÓN CABLES ENCENDIDO

Modelo	Cil.	Distribuidor	Año inicial	Año final	Serie # inicial	Serie # final	Juego enchufe cable
350 Mag Bravo MPI	8	Delco EST	1995	1996	0F415189	0K999999	18-8822-1
350 Mag EFI Ski	8	Delco EST	1994	1997	0F215561	0K999999	18-8822-1
350 Mag MPI	8	Delco EST	1998	1998	0L010019	0L325952	18-8822-1
350 Mag MPI Alpha	8	Delco HVS	2001	& Sup	0M300000	& Sup	18-8828-1
350 Mag MPI Bravo	8	Delco HVS	2001	& Sup	0M300000	& Sup	18-8828-1
350 Mag MPI Horizon	8	Delco HVS	2001	& Sup	0M300000	& Sup	18-8828-1
350 Mag MPI Horizon MIE	8	Delco HVS	2001	& Sup	0M300000	& Sup	18-8828-1
350 Mag MPI MIE	8	Delco HVS	2001	& Sup	0M300000	& Sup	18-8828-1
350 Mag MPI Ski	8	Thunderbolt IV	1991	1996	0D505450	0K40399	18-8821-1
350 Mag MPI Ski	8	Thunderbolt V	1991	1997	0D505450	0K999999	18-8821-1
5.7L Alpha	8	Thunderbolt IV	1988	1995	0B773305	0F600999	18-8821-1
5.7L Alpha	8	Thunderbolt V	1996	1997	0F601000	& Sup	18-8821-1
5.7L Bravo	8	Thunderbolt IV	1988	1993	0B773305	0F353524	18-8821-1
5.7L Bravo	8	Thunderbolt V	1994	& Sup	0F353525	& Sup	18-8821-1
5.7L EFI	8	Delco EST	1995	1998	0F225560	0L339999	18-8822-1
5.7L EFI MIE	8	Delco EST	1997	1997	0K040300	0K999999	18-8822-1
5.7L MIE	8	Thunderbolt IV	1988	1995	0B788152	0F746099	18-8821-1
5.7L MIE	8	Thunderbolt V	1996	1997	0F622100	0K999999	18-8821-1
5.7L MIE	8	Thunderbolt V	1998	& Sup	0L002003	& Sup	18-8821-1
5.7L Ski	8	Mallory/Prestolite	1985	1995	0A338553	0F775199	18-8802-1
5.7L Ski	8	Thunderbolt IV	1987	1995	0B514627	0F775199	18-8821-1
5.7L Ski	8	Thunderbolt V	1996	1997	0F775200	0K999999	18-8821-1
5.7L Ski	8	Thunderbolt V	1998	& Sup	0L002005	& Sup	18-8821-1
5.7LX Alpha & Bravo	8	Thunderbolt V	1996	1997	0F601000	0K999999	18-8821-1
5.7LX Bravo & EFI	8	Delco EST	1996	1997	0F752400	0K999999	18-8822-1
233 MCM & MIE (Ford)	8	Mercury/Prestolite	1975	1977	4173000	4902304	18-8803-2
255 MCM & MIE (Ford)	8	Mercury/Mallory	1973	1980	3258728	5907057	18-8803-2
MX 6.2L MPI	8	Delco HVS	2001	& Sup	0M300000	& Sup	18-8828-1
MX 6.2L MPI Horizon	8	Delco HVS	2001	& Sup	0M300000	& Sup	18-8828-1
MX 6.2L MPI Horizon MIE	8	Delco HVS	2001	& Sup	0M300000	& Sup	18-8828-1
MX 6.2L MPI MIE	8	Delco HVS	2001	& Sup	0M300000	& Sup	18-8828-1
377 MAG MPI BRAVO	8	Delco HVS	TODOS	TODOS	1A300000	& Sup	18-8828-1
325 MCM & MIE	8	Thunderbolt	1969	1974	2278747	& Sup	18-8803-2
325 MCM & MIE	8	Mallory	1969	1972	2278747	& Sup	18-8803-2
390	8	Mallory	1968	1970	TODOS		18-8803-2
330	8	Mallory	1977	1981	4623115	6083144	18-8803-2
330	8	Thunderbolt	1977	1981	4623115	6083144	18-8803-2
330	8	Thunderbolt IV	1982	1987	6083145	0B816540	18-8821-1
340 MIE	8	Thunderbolt IV	1981	1987	5889914	0B788365	18-8821-1
350 MIE	8	Thunderbolt	1974	1976	3780450	4623109	18-8803-2
370 TRS	8	Mallory/Holley	1978	1985	4179554	6721527	18-8803-2
370 TRS	8	Thunderbolt IV	1985	1987	6721528	0B714586	18-8821-1
400 TRS	8	Mallory/Holley	1980	1986	5668232	0B457644	18-8803-2
440 TRS	8	Mallory/Holley	1983	1986	6181070	0B485220	18-8803-2
450	8	Thunderbolt IV	1995	1996	0F347100	0F347277	18-8821-1
454 Mag Alpha	8	Thunderbolt IV	1986	1988	0A631894	0B785148	18-8821-1
454 Mag Bravo	8	Thunderbolt IV	1988	1997	0B721206	0K999999	18-8821-1
454 Mag EFI	8	Delco EST	1994	1996	0F115700	0F802349	18-8822-1
454 Mag MPI	8	Delco EST	1996	2001	0F802350	M024999	18-8822-1
454 Mag MPI Horizon MIE	8	Delco EST	1999	2001	0L002200	0L674000	18-8822-1
454 Mag MPI Ski	8	Delco EST	1995	1997	0F215800	0K999999	18-8822-1
7.4L Bravo I, II, III	8	Thunderbolt IV	1988	1997	0B771113	0K999999	18-8821-1

APLICACIONES CONTINUAN EN LA SIGUIENTE PÁGINA

MERCURUISER MARINE APLICACIÓN CABLES ENCENDIDO

Modelo	Cil.	Distribuidor	Año inicial	Año final	Serie # inicial	Serie # final	Juego enchufe cable
7.4L Bravo III	8	Thunderbolt V	1992	1997	603118	0K999999	18-8821-1
7.4L EFI MIE	8	Thunderbolt IV	1988	1996	0B788366	0F820141	18-8821-1
7.4L MIE	8	Thunderbolt IV	1988	1996	0B788366	0F820141	18-8821-1
7.4L MIE	8	Thunderbolt V	1992	1997	0D715494	0K999999	18-8821-1
7.4L MPI (L29)	8	Delco EST	1998	2001	0L010003	0M024330	18-8822-1
7.4L MPI MIE	8	Delco EST	1995	2001	0F563052	0M025999	18-8822-1
7.4LX Bravo EFI & MPI	8	Delco EST	1996	1997	0F602010	0K999999	18-8822-1
390	8	Thunderbolt	1969	1970	2781129	2825059	18-8803-2
460 TRS	8	Mallory/Holley	1983	1986	6180970	6181046	18-8803-2
460 Ciclon	8	TODOS	1983	1985	TODOS		18-8803-2
496 Mag & Mag HO	8	Delco (coil over plug)	2000	& Sup	0M025000	& Sup	18-8838-1
8.1 MIE & HO MIE	8	Delco (coil over plug)	2000	& Sup	0M025000	& Sup	18-8838-1
502 Mag Bravo	8	Thunderbolt IV	1990	1993	0G878221	0F114528	18-8821-1
502 Mag EFI	8	Delco EST	1993	1996	0B40650	0F802599	18-8822-1
502 Mag MPI	8	Delco EST	1996	2001	0F802600	0M024999	18-8822-1
525 SC	8	Thunderbolt IV	1991	1995	0D456000	0F877734	18-8821-1
8.2L MIE	8	Thunderbolt IV	1990	1996	0C878221	0F819619	18-8821-1
8.2L MPI MIE	8	Delco EST	1996	2001	0F819620	0L674200	18-8822-1



**18-5225
KIT CABLES BUJÍAS**
Reemplaza: Mercury 84-99215A26, 84-813706A26, 84-93475A26, 84-93212A1, 84-90816A26
Kit incluye 25 pies de cable de encendido de 7 MM hypalon con alma metálica y un amplio surtido de 3 tipos de terminales para fuer-abordas.



**18-5226
CABLE ENCENDIDO
Alma metálica
100' bobina
7mm Hypalon**



CABLES BATERIA

Ref No.	talla	Color	Calibre	Ref No.	talla	Color	Calibre
BC88523	2'	rojo	4	BC88563	6'	rojo	2
BC88533	2'	negro	4	BC88573	6'	negro	2
BC88543	4'	rojo	2	BC88583	8'	rojo	1
BC88553	4'	negro	2	BC88593	8'	negro	1

Terminales soldados para terminal de 3/8"

Pack de 10



**18-5224
18-5224-9①
TERMINAL CABLE BUJÍAS**
Reemplaza: 20121, 8M0084600

Pack de 10



**18-5750
18-5750-9①
TAPA BUJÍAS UNIVERSAL**
Suministrado con conector terminal completo



**18-5752
TAPA BUJIAS UNIVERSAL
8mm**

**18-55510
MOTOR DE ARRANQUE**
Reemplaza: 8M0095471.
Para: 4.5L y 6.2 no motores GM



Standard Rotation

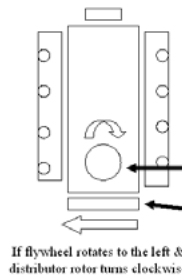

CCW Rotation

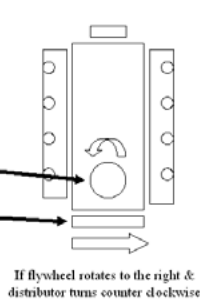

18-5603

ARRANQUE

Reemplaza: 50-808011A4

Entrada trasera de montaje superior CCW arranque para rotación estándar motores GM & Ford. Pueden utilizarse en lugar de 18-5908

18-6275

ARRANQUE

Reemplaza:

50-807904A1, 50-863007A1, 50-864340A2, 50-806964A4, 50-806964A3, 50-806964A2, 50-812604A2, 50-812428A3, 50-812428A3, 50-12177A2, 50-12121A2, 50-822330A2, 814472, 50-99418A2, 50-77328A3, 50-77328A1

• Engranaje magnético permanente

• Intraborda

• 2 tornillos

• Rotación CW • SAE J1171

• Use con último modelo motores 3.0L con 14" volante

Para : Volvo Penta, Mercruiser, Marine Power

Use Solenoide 18-5811

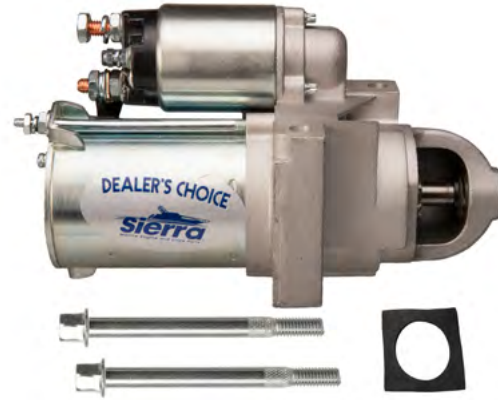

18-5920

ARRANQUE

PMGR remplace para 18-5903; 302CID, 351CID Motores Ford



18-5911

ARRANQUE

(Heavy-Duty) (Rotación agujas reloj) (9 dientes) Para motores GM ,montaje inferior, tornillos paralelos y rotación estándar. Rotación estándar

Reemplaza: 50-76965A4, 50-99417A2, 50-99419A3, 50-17251A3

Reemplaza Solenoide: 18-5837

SAEJ1171



18-5907

ARRANQUE

(Heavy-Duty) (Rotación agujas del reloj) (9 dientes) Montaje superior, entrada posterior motores GM & Ford. Rotación opuesta.

Mercuriser 4 cil. 165/170/180/190/470/485/488

Reemplaza: 50-72550A2,50-79604A3, 50-97499A2, 50-97499R4, 50-72550R2, 50-97499R3

Reemplaza solenoide: 18-5837

SAEJ1171

18-5913
ARRANQUE
(Sentido reloj)
Delco magnético permanente 2 tornillos
12V - 11 dientes - tornillos desplazados
Para: Último modelo GM - 14" volante
Reemplaza: 50-812428A3, 50-812604A2,
50-822330A2, 50-864340A2
Incluye 18-8402 (2) tornillos
Reemplaza Solenoide: 18-6287
SAEJ1171 PARA: 4.3L (1996 & SUP); 5.0 & 5.7L (1998 & SUP)



CE

18-5919
ARRANQUE
magnético permanente I/O starter, 11 dientes
Reemplaza: 50-806963A4, 50-806965A2, 50-806965A4
Solenoide de recambio: 18-6287
Incluye 1 tornillo 18-8402 y 1 tornillo 18-8404
Para: Motores chevy con volante de 12 3/4"
SN-OF803000AN/OF803114AN 4.3LX/LXH Alpha/Bravo 262 CID
SN-355305AN/22560AN 5.7L Alpha (EFI)/5.7L Bravo (EFI)
SAEJ1171

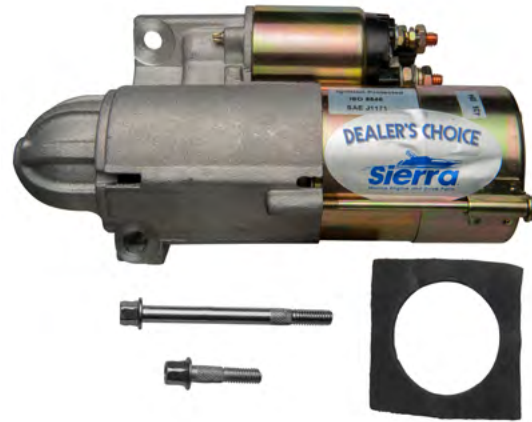

CE

18-5910
ARRANQUE
(Heavy-Duty) (Giro agujas del reloj) (9 dientes) bloque pequeño V-6 & V-8 GM motores con volante de 14 1/4". Para motores con rotación estandar.
Reemplaza: 50-12177A2, 50-99418A2



CE
MARINE
UL
LISTED

18-5908
ARRANQUE
(Heavy-Duty) (Giro contrario a las agujas del reloj) (9 dientes)
Montaje superior, entrada posterior motores GM & Ford. Para motores rotación estándar.
Reemplaza: 50-76965A3, 50-808011A1, 50-808011A05, 50-808011A4, 50-808011A3, 50-99419A3, 50-76967A4, 50-76967A1
50-65784A1, 50-47455, 50-17251A3, 50-17251A2
Reemplaza Solenoide: 18-5837
SEAJ1171



CE



18-5903
ARRANQUE
 (Giro agujas del reloj) Montaje inferior, dos tornillos, para motores ford rotación estándar.
 Reemplaza: 50-69865A1, 50-12872, 50-56886
 Reemplaza Solenoide: 18-5801
 *Para tipo PMGR style order 18-5923

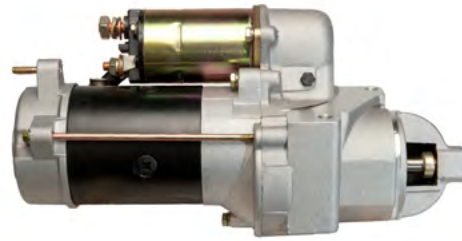

18-6870
ARRANQUE
 Reemplaza: Mercury 50-805833, T
 Para: D7.3L D-tronic 260 LD, 300 año 1999



18-6946
ARRANQUE
 Reemplaza: 50-8m8021116
 Para: Alto rendimiento de arranque de 11 dientes para 6.2L & Escorpión 8.9L HO aplicaciones



18-6947
ARRANQUE
 Reemplaza: Mercruiser 50-805991
 Para: 7.3L (BRAVO & MIE) DIESEL NAV 444 V-8 1994-1996

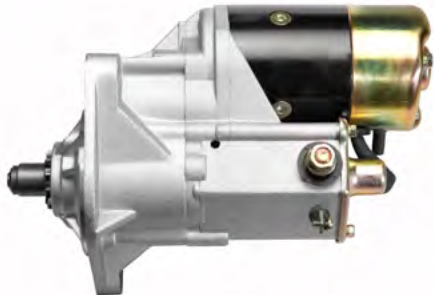

18-6949
ARRANQUE
 Reemplaza: Mercruiser 50-831001562, 50-831001961
 Para: WO4CTA (150 HP) HINO 234 I/L4, WO4CTI (210 HP) HINO 234 I/L4



18-6957
ARRANQUE
 Reemplaza: Mercruiser 50-801333980, 50-854178, 50-855507



18-8412
EXTENSIÓN TORNILLO ARRANQUE
 Alarga la conexión del solenoide que requiere más conexiones.



18-2434
ALOJAMIENTO
 Reemplaza: 814309A1
 Para: GM V-8's bloques grandes y pequeños intraborda/modelos ski

TORNILLOS ARRANQUE



Descripción	Mercruiser #	Ref #
Tornillo arranque 3/8 - 16 - 4 3/8 Largo	10-8053432	18-8402
Tornillo arranque 3/8 - 16 - 1 11/16 Largo	10-8083434	18-8404-1



**18-5717
JUEGO ESCOBILLAS**
Reemplaza: 33270

**18-5804
SOLENOIDE**
Reemplaza: 13037
Delco



**18-5837
SOLENOIDE**
Reemplaza: 89-99253, 89-18080, 89-89902, 89-33316, 89-60687
Delco



**18-5838
SOLENOIDE**
Reemplaza: 33261, 89902
Delco



**18-5840
SOLENOIDE**
Prestolite 15-79,
SAW 4201, SAW4207, SAW4210



APLICACIONES JUEGO ESCOBILLAS/INTERRUPTOR DE ARRANQUE

Años	Volt.	Arranque No.	Juego Escobillas	Interruptor arranque	Años	Volt.	Arranque No.	Juego escobillas	Interruptor Arranque
1977-82	12	1108755	18-5717	18-5838	1971-78	12	TODOS	18-5717	18-5838
1977-82	12	1108756	18-5717	—	1969-78	12	MEO-7003	—	18-5840
1977-82	12	1109484,5,6	18-5717	18-5838					

① **18-5801D** Display Package

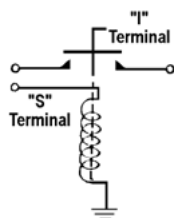

**18-5801
SOLENOIDE**
Reemplaza: 89-76416A1

① **18-5802D** Display Package

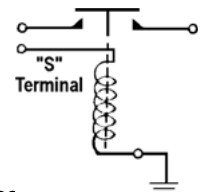

**18-5802
SOLENOIDE**
Base tierra
Reemplaza: 65057A1, 65057T1, 65057, 54981

① Referencias acabadas en "D" envasadas - Referencias normales no envasadas
APLICACIONES EMPIEZAN EN LA PÁGINA 58

① 18-5810D 

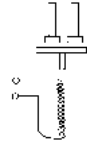

18-5810
SOLENOIDE



18-5811
ARRANQUE SOLENOIDE
Reemplaza: 809463A1, 8094631, 809463, 8094621, 809462
Para: PG 260 Serie arranque, GM V6 & V8 (1983-Sup)

① 18-5815D 

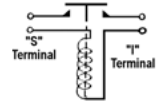

18-5815
SOLENOIDE
Reemplaza: 89-68258A4, 89-853654A1, 89-76545, 89-76545T, 89-65258, 89-61053, 89-15857

① 18-5816D 

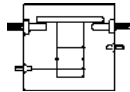

18-5816
SOLENOIDE
Reemplaza: 89-96054, T, 89-91975
(Soporte plano)

① 18-5817D 

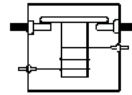

18-5817
SOLENOIDE
Reemplaza: 89-96158, 89-96158T, 94318, 846070
(Soporte curvado)

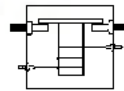
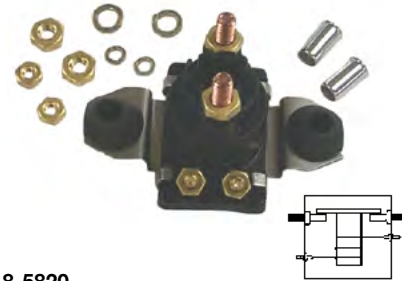

18-5820
SOLENOIDE
Reemplaza: 89-818999A2, 89-825842A1, 89-850188T1

① 18-5836D 

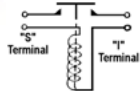

18-5836
SOLENOIDE
Reemplaza: 25661, 256611, 25661T1



18-9802
Luz cronometraje
Para más de 10,000 RPM's



18-6749
SOPORTE TRIM
Soporte metálico
Reemplaza: 862548A1, 42419A1, 88893A4, 88553A1, 862548A1, 58397A3, 58397A2, 42419A1
Para: Soporte de montaje al suelo MerCruiser



18-6750
SOPORTE TRIM
Acero inox
Reemplaza: 862548A1, 42419A1
Para: Soporte de montaje al suelo MerCruiser



18-6747
TILT/ TRIM
Reemplaza: 865380A25, 865380A15, 865380A05, 865380A02, 14336A28, 14336A22, 14336A17, 14336A15, 14336A9, 14336A6, 88183A12, 88183A3
Para último modelo aplicaciones colas



18-6752
BOMBA HIDRÁLICA TRIM
Baja presión - Caudal alto
Soporte metálico
Reemplaza: 14336A9, 88183A12, 96477A3, 88183A11, 88183A6, 865380A25, 865380A15, 865380A05, 865380A02, 14336A28, 14336A22, 14336A17, 14336A15, 14336A6
Para: 1983 y último sin "Conector rápido"
Reemplaza Motor: 18-6772
Fusibles 20 amp



18-6753
BOMBA HIDRÁLICA TRIM
Baja presión - Caudal alto
Soporte acero inox
Reemplaza: 14336A9, 88183A12
Para: 1983 y último sin "quick connect"
Reemplaza Motor: 18-6772
Fusibles 20 amp

① Referencias acabadas en "D" envasadas - Referencias normales no envasadas

APLICACIONES EMPIEZAN EN LA PÁGINA 58

18-6768

BOMBA POWER TRIM

Soporte acero

Reemplaza: 93247A7, 93247A4, 392-8261A1, 392-8263, 88475A4, 79271A4, 74436A9

Reemplaza bomba de alta presión Prestolite/Sistema de bajo caudal. Utiliza principalmente 1982 y anteriores. Fusibles 20 amp



18-6799

KIT BOMBA POWER TRIM

Soporte acero inox

93247A7, 93247A4, 392-8261A1, 392-8263, 88475A4, 79271A4, 74436A9

Reemplaza bomba para Prestolite alta presión/Sistema caudal bajo. Agua salada. Soporte acero inox. Utiliza principalmente 1982 y anteriores. Fusibles 20 amp.



18-6763

MOTOR TILT/TRIM

Reemplaza: 92975A6, 79271A4, 67914A2, 92975A32, 93247A7

Para 1984. Para mayoría colas Mercuriser Stern-drives (Motor y solo depósito)
Para kit reparación use: 18-6253

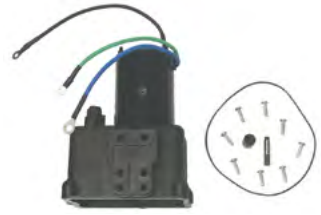

18-6769-1

BOMBA TILT/TRIM

Baja presión - Caudal alto

Reemplaza: 14336A8, 88183A5 From 1984
Para mayoría colas Mercuriser



18-6772

BOMBA MOTOR TILT

Reemplaza: 17649, 17649T, 891736T

Para últimos modelos de Alpha I, Generation II, y dirección Bravo; Primeros modelos de square motores. Colas Mercuriser reemplaza por unidades Oildyne



18-6813

MOTOR TRIM

Baja presión/Caudal alto

Reemplaza: 14336A6, A8, A9, A15, A20, 88183A5, A8, A12, 865380A13, A25

Igual que 18-6769-1, además de cableado
Reemplaza Solenoide: 18-5817



18-6771

DEPÓSITO TILT/TRIM

Reemplaza: 18525, 18525A1, 17646



18-6778

TILT/TRIM DEPÓSITO

Reemplaza: 883166A1, 883166A2
Para: Motores Tilt con 4 tornillos



18-6823

CABLEADO

Reemplaza: Universal

Convierte 3-cable Tilt y Trim
Motres de 2-cables diseño



18-6746

MOTOR TILT/TRIM

Reemplaza: 14336A20, 14336A25, 14336A31, 14336A8, 865380A03, 865380A13, 88183A5"

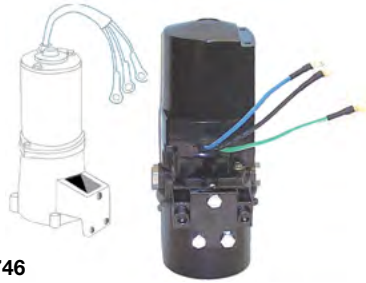

18-6253

PLATINA CONMUTADOR

Use con 18-6763



18-15501

DISYUNTOR

Reemplaza: 88-93582
60 AMP

18-6256

KIT MUELLE

Reemplaza: 392-2529
Para : Use con bomba Prestolite (Mercury #'s 74436A9, 79271A4, 88475A5 y 93247A4)



18-6255

KIT ESCOBILLAS

Reemplaza: 392-8989
Para: Use con bomba Prestolite (Mercury #'s 93247A4)





18-6293
ALTERNADOR
Reemplaza: 862031T, 862031T1 • SAE J1171
7SI/70 amp, montaje de bisagra, Polea de serpiente 2.44"
Diámetro



18-6298
ALTERNADOR
Reemplaza: 863077T • SAE J1171
7SI/70 amp, montaje bisagra,
Polea de serpiente 1.97" Diámetro



18-5983
ALTERNADOR
Reemplaza: 862030T • SAE J1171
7SI/70 amp, montaje bisagra, polea sencilla



18-5956
ALTERNADOR
(1-cables) (No Core) (68 AMP)
Se adapta a Mercruiser y muchas otras aplicaciones
equipado con ventilador y polea.
Reemplaza: 69729, 90794, 78403A2,
78403A1, 78477, 59755, 56045
SAE J1171



18-5957
ALTERNADOR
(3-Cables) (68 AMP)
Reemplaza Mando, Motorola y el original Delco. Usa
las mismas conexiones eléctricas y metodo de mon-
taje. Equipado con ventilador y polea.
Reemplaza: 78477, 78403A2, 92497A3,
78403A1, 90794, 69729, 59755, 56045,
817119A4, 817119A1, 98555A1, 92497,
12449A1, 12449
SAE J1171



18-5946
ALTERNADOR
(1-Cable) (68 AMP)
Se adapta a Mercruiser y muchas otras aplicaciones.
Equipado con ventilador y polea. • SAE J1171



18-5945
ALTERNADOR
(3-Cables) (68 AMP) • SAE J1171
Reemplaza Mando, Motorola y el original Delco. Usa
las mismas conexiones eléctricas y metodo montaje.
Equipado con ventilador y polea.



18-5960
ALTERNADOR
Polea de serpiente • 65 Amp
Reemplaza: 807653T • SAE J1171



18-5966
ALTERNADOR
Polea de ranura única • 55 Amp
Reemplaza: 817119A4, 12449A1, 98555A1,
92497, 817119A1, 12449A1, 12449
• SAE J1171



18-5967
ALTERNADOR
Polea de serpiente • 55 Amp
Reemplaza: 807652T • SAE J1171



18-5965
ALTERNADOR
65 Amp
Reemplaza: 817119A1, 817119A4,
805884T, 98555A1, 92497A3, 92497,
12449A1, 12449
SAE J1171



18-6841
ALTERNADOR
Reemplaza: 56045, 59755, 69729,
78403A2, 78403A1, 78477, 90794
Para: Aplicaciones 37-63A Marine



18-6842
ALTERNADOR
Reemplaza: 56045, 59755, 69729, 78403A2,
78403A1, 78477, 90794
Para: Aplicaciones 37-63A Marine



18-6844
ALTERNADOR
Reemplaza: Mercruiser 834832,
T2, 857006A3,
Denso 101211-3460



18-6975
ALTERNADOR (Universal)
Para: Alternador alto amp 160A,
montaje universal diseño Delco
CS1300, correa y polea serpiente
incluida.

APLICACIONES EMPIEZAN EN LA SIGUIENTE PÁGINA



**18-6948
ALTERNADOR**
Reemplaza: 882571, 8M0084523
Para: CMD 1.7 MI 120 I/L4, CMD 1.7 MS 120 I/
L4, D1.7L DTI



**18-6960
ALTERNADOR**
Reemplaza: Mercruiser 821663,
8216631, 821663A1
Denso 101211-3020, 3021



**18-5953-1
KIT CONVERSIÓN ALTERNADOR**
Incluye nuevo 18-5956 68 AMP alternador, soporte montaje 18-5968, polea (8.0" D.O. x 2.75" H), cableado, tornillería e instrucciones. Convierte modelo 470 bloque de aluminio con número de serie 4625580 & sup con stator sistema de carga y refrigerado regulador de voltaje a sistema alternador. NOTE: Kit fusible 18-8220 (se vende por separado) se requieren con motores de arranque Delco starters; Motores de arranque Prestolite con solenoide remoto no requieren el kit fusible. Compruebe visualmente el motor de arranque antes de pedirlo.
Para: Mercruiser 224 / 3.7L



**18-5949
KIT CONVERSIÓN CORREA**
3/8" x 33 1/2"
Reemplaza kit de conversión de correa de alternador usado en la serie 470 Mercruiser. Incluido en el kit 18-5953-1.



**18-5968
SOPORTE ALTERNADOR**
Reemplaza soporte para alternador kit conversión Utilizado en la serie 470 Mercruiser incluido en el kit de 18-5953



**18-8220
KIT FUSIBLE**
Reemplaza: 88-79023A91
Para uso con 18-5953 alternador kits conversión instalado en Mercruiser (Model 470) 3.7 litros bloques de aluminio con número de serie 6902288 & sup.
90 AMP



**18-5740
REGULADOR DE VOLTAJE**
Reemplaza: 42785

Modelo #	Cil.	Años	Desde. S/N	Hasta. S/N	Solenoide	Arranque Remanufacturado	Nuevo arranque	Alternador Remanufacturado	Nuevo Alternador
110	GM 4	1963-1966	1538370	2044033	18-5836	18-5911	18-5911	—	—
120	GM 4	1964-1975	1666601	4469865	18-5836	18-5911	18-5911	18-5957	18-5957
120	GM 4	1976-1982	4469866	6229717	18-5815	18-5911	18-5911	18-5957	18-5957
120 / 2.5L	GM 4	1983-1989	6229718	C853255	18-5817	18-5911	18-5911	—	18-5966 ④
140	GM 4	1968-1975	2508261	4460664	18-5836	18-5911	18-5911	18-5957	18-5957
140	GM 4	1976-1981	4460665	6229717	18-5815	18-5911	18-5911	18-5957	18-5957
140/3.0L	GM 4	1982-1989	6229718	C856558	18-5817	18-5911	18-5911	18-5957	18-5957
140/3.0L	GM 4	1999-2001	0L382122	0M326292	18-5817	—	18-6275	—	18-5983 **
140/3.0L/3.0LX	GM 4	1990-92	C856559	D831100	18-5817	18-5911	18-5911	18-5957	18-5957
140/3.0LX	GM 4	1992-97	D831101	0K999999	18-5817	N/D	18-6275	—	18-5966 ④
165/3.7L	Merc 4	1987-1989	B434941	C762299	18-5802	18-5907	18-5907	N/D	N/D
170	Merc 4	1985-1986	6916779	B434940	18-5802	18-5907	18-5907	N/D	N/D
180/3.7LX	Merc 4	1987-1989	B436391	C762299	18-5802	18-5907	18-5907	N/D	N/D
190	Merc 4	1985-1986	6916779	B436390	18-5802	18-5907	18-5907	N/D	N/D
470	Merc 4	1976-1984	4208730	6916778	18-5802	18-5907	18-5907	N/D	N/D
470MIE	Merc 4	1980-1981	5520115	6218036	18-5802	18-5907	18-5907	N/D	N/D
485	Merc 4	1980-1984	5685394	6916778	18-5802	18-5907	18-5907	N/D	N/D
140	GM 6	1963	1538930	1725960	18-5836	18-5911	18-5911	—	—
150	GM 6	1964-66	1666495	2048046	18-5836	18-5911	18-5911	—	—
160	GM 6	1967-69	2048022	2768031	18-5836	18-5911	18-5911	—	—
160	GM 6	1969	2768032	2770031	18-5836	18-5911	18-5911	18-5957	18-5957
165	GM 6	1970-1975	2770032	4471565	18-5836	18-5911	18-5911	18-5957	18-5957
165	GM 6	1976-1981	4471566	5813433	18-5815	18-5911	18-5911	18-5957	18-5957
200	GM 6	1969	2453769	2712072	18-5836	18-5911	18-5911	—	—
175/4.3L	GM V-6	1987-1992	B527955	D714106	18-5816	—	18-5913	—	18-5966 ④
185	GM V-6	1983-1984	6330183	6919655	18-5816	18-5911	18-5911	—	18-5966 ④
185	GM V-6	1985-1987	A331455	B527954	18-5816	N/D	18-5913	—	18-5966 ④
205	GM V-6	1985-1991	A331455	D714369	18-5816	N/D	18-5913	—	18-5966 ④
262 Mag. EFI	GM V-6	1996-1997	F803800	K999999	18-5817	N/D	18-5913	—	18-5960
262 Mag. EFI	GM V-6	1996-1997	F803800	K999999	18-5817	N/D	18-5913	—	18-5960
4.3L/LX/LXH	GM V-6	1992-1997	D714107	K999999	18-5817	—	18-5913	—	18-5967
4.3L/LX/LXH	GM V-6	1996-1997	F803000	K999999	18-5817	—	18-5913	—	18-5967
4.3L/LH	GM V-6	1998-99	L010044	0L618999	18-5817	—	18-5913	—	18-5967
4.3L/LH(Gen +)	GM V-6	2000-02	0L619000	0M320024	18-5817	—	18-5913	—	18-6293 **
4.3EFI	GM V-6	1998-99	L012009	0L618999	18-5817	—	18-5913	—	18-5960
4.3L EFI	GM V-6	2000-01	0L619000	0M299999	18-5817	—	18-5913	—	18-6293 **
4.3L MPI	GM V-6	2002	0M300000	0M320024	18-5817	—	18-5913	—	18-6293 **
190	GM V-8	1963-1964	1564539	1730903	18-5836	18-5911	18-5911	—	—
200	GM V-8	1985-1986	6218462	B525981	18-5816	18-5911	18-5911 ① ③	—	18-5966 ④
200	GM V-8	1985-1986	6218462	B525981	18-5816	18-5910	18-5910 ② ⑥	—	18-5966 ④
200/5.0L	GM V-8	1987-1995	B525982	F600999	18-5816	18-5910	18-5910	—	18-5966 ④
200/5.0L	GM V-8	1987-1995	B525982	F600999	18-5817	18-5910	18-5910	—	18-5966 ④
215 MCM & MIE	Ford V-8	1970-1972	2781153	3563181	18-5836	18-5908	18-5908 ①	18-5957	18-5957

① Para volante diámetro 12 3/4"
② Para volante diámetro 14"
③ Modelos c/magneto permanente use 18-5919
④ 55 AMP hasta 65 AMP use 18-5965
⑤ Negro
⑥ Modelos c/magneto 18-5913
⑦ Dirección Bravo
⑧ Encendido Firepower
⑨ Modulo encendido montado en distribuidor
⑩ Modulo encendido montado en codo
⑪ Rotación izq.
⑫ NLA p/ modelos anteriores a S/N 4167000
⑬ PG 260 (9-1/4" largo)
⑭ PG260F1 (8-1/2" largo)
⑮ Rotación derecha
⑯ Encendido estándar
⑰ Encendido Thunderbolt
⑱ Thunderbolt IV
⑲ Thunderbolt V
⑳ Modelos transmisión Delco Style

Modelo #	Cil.	Años	Desde. S/N	Hasta. S/N	Solenoide	Arranque remanu	Arranque nuevo	Alternador Remanufact.	Alternador Nuevo
215 MCM & MIE	Ford V-8	1970-1972	2781153	3563181	18-5836	18-5907	18-5907 ⑤	18-5957	18-5957
225	Ford V-8	1973-1974	3385721	4166999	18-5802	18-5903	—	18-5957	18-5957
225 MIE	Ford V-8	1973-1974	3385721	4176999	18-5836	18-5908	18-5908 ①	18-5957	18-5957
225 MIE	Ford V-8	1973-1974	3385721	4176999	18-5836	18-5907	18-5907 ⑤	18-5957	18-5957
888	Ford V-8	1971-1977	3108723	4612109	18-5802	18-5903	—	18-5957	18-5957
888	Ford V-8	1971-1977	4612110	& Sup	18-5801	18-5903	—	18-5957	18-5957
225	GM V-8	1963-1966	1539620	2278646	18-5836	18-5911	18-5911	—	—
225 MIE	GM V-8	1968	2278647	2694014	18-5836	18-5908	18-5908 ①	—	—
225 MIE	GM V-8	1968	2278647	2694014	18-5836	18-5907	18-5907 ⑤	—	—
225	GM V-8	1967-1969	2278647	2694014	18-5836	—	—	—	—
228/230	GM V-8	1977-1986	4765100	B525981	18-5816	18-5911	18-5911 ① ③	—	18-5966 ④
228/230	GM V-8	1977-1986	4765100	B525981	18-5816	18-5910	18-5910 ② ⑥	—	18-5966 ④
228 MIE	GM V-8	1977-1980	4765100	5907057	18-5815	18-5908	18-5908 ①	18-5957	18-5957
228 MIE	GM V-8	1977-1980	4765100	5907057	18-5815	18-5907	18-5907 ⑤	18-5957	18-5957
230/5.0LX	GM V-8	1987-1995	B525982	F600999	18-5816 ⑩	18-5910	18-5910 ③	—	18-5966 ④
230/5.0LX	GM V-8	1987-1995	B525982	F600999	18-5817 ⑨	18-5910	18-5910 ③	—	18-5966 ④
230/5.0L MIE	GM V-8	1987-1988	5907058	B788151	18-5816	18-5908	18-5908 ①	—	18-5966 ④
230/5.0L MIE	GM V-8	1987-1988	5907058	B788151	18-5816	18-5907	18-5907 ⑤	—	18-5966 ④
5.0L(Gen +)	GM V-8	1998-99	L015751	L618999	18-5817	—	18-5913	—	18-5967
5.0L(Gen +)	GM V-8	2000-2002	L619000	M320024	18-5817	—	18-5913	—	18-6293 **
5.0L EFI	GM V-8	1998-99	L012052	L618999	18-5817	—	18-5913	—	18-5960
5.0L EFI	GM V-8	2000-01	L619000	M299999	18-5817	—	18-5913	—	18-6293 **
5.0L MPI	GM V-8	2002	M300000	M320024	18-5817	—	18-5913	—	18-6293 **
198 MIE	GM V-8	1977	4762210	6218461	18-5815	18-5908	18-5908 ①	18-5957	18-5957
198 MIE	GM V-8	1977	4762210	6218461	18-5815	18-5907	18-5907 ⑤	18-5957	18-5957
898	GM V-8	1977-1982	4762210	6218461	18-5801	18-5911	18-5911	18-5957	18-5957
898	GM V-8	1983-1984	621462	B525981	18-5816	18-5911	18-5911 ① ③	—	18-5966 ④
898	GM V-8	1983-1984	621462	B525981	18-5816	18-5910	18-5910 ② ⑥	—	18-5966 ④
233	Ford V-8	1975-1977	4173000	4902304	18-5801	18-5903	—	18-5957	18-5957
233 MIE	Ford V-8	1975-1976	4173000	4775784	18-5836	18-5908	18-5908 ①	18-5957	18-5957
233 MIE	Ford V-8	1975-1976	4173000	4775784	18-5836	18-5907	18-5907 ⑤	18-5957	18-5957
250 MCM & MIE	GM V-8	1968-1969	2314301	2639854	18-5836	18-5908	18-5908 ①	—	—
250 MCM & MIE	GM V-8	1968-1969	2314301	2639854	18-5836	18-5907	18-5907 ⑤	—	—
250	GM V-8	1977	4768000	4908849	18-5801	18-5911	18-5911	18-5957	18-5957
255	Ford V-8	1973-1974	3258728	4175499	18-5802	18-5903	—	18-5957	18-5957
255 MIE	Ford V-8	1973-1974	3258728	4178299	18-5836	18-5908	18-5908 ①	18-5957	18-5957
255 MIE	Ford V-8	1973-1974	3258728	4178299	18-5836	18-5907	18-5907 ⑤	18-5957	18-5957
255	GM V-8	1975-1976	4175500	4767999	18-5815	18-5911	18-5911	18-5957	18-5957
255 MIE	GM V-8	1975-1980	4175500	5907057	18-5815	18-5908	18-5908 ①	18-5957	18-5957
255 MIE	GM V-8	1975-1980	4175500	5907057	18-5815	18-5907	18-5907 ⑤	18-5957	18-5957
260	GM V-8	1978-1982	4908850	6218461	18-5801	18-5911	18-5911	18-5957	18-5957
260	GM V-8	1982-1986	6218462	B525981	18-5816	18-5911	18-5911 ① ③	—	18-5966 ④
260	GM V-8	1982-1986	6218462	B525981	18-5816	18-5910	18-5910 ② ⑥	—	18-5966 ④
260/5.7L	GM V-8	1987-1995	B525982	F600999	18-5816 ⑩	18-5910	18-5910 ⑥	—	18-5966 ④
260/5.7L	GM V-8	1987-1995	B525982	F600999	18-5817 ⑨	18-5910	18-5910 ⑥	—	18-5966 ④
260/5.7L MIE	GM V-8	1987-1995	5907058	F746099	18-5816	18-5908	18-5908 ①	—	18-5966 ④
260/5.7L MIE	GM V-8	1987-1995	5907058	F746099	18-5816	18-5907	18-5907 ⑤	—	18-5966 ④
5.7L/LX	GM V-8	1996	F601000	K001526	18-5817	—	18-5913	—	18-5966 ④
5.7L/LX	GM V-8	1997 & sup	K001527	& sup	18-5817	—	18-5913	—	18-5967
5.7L	GM V-8	2000-02	L619000	M320024	18-5817	—	18-5913	—	18-6293 **
5.7L/LX EFI	GM V-8	1995-1996	F225560	K001505	18-5816	—	18-5913	—	18-5965
5.7L/LX EFI	GM V-8	1997	K001506	K999999	18-5816	—	18-5913	—	18-5960
5.7L EFI	GM V-8	1998 & sup	L010035	& sup	18-5816	—	18-5913	—	18-5960
5.7L EFI	GM V-8	2000-01	L619000	M299999	18-5816	—	18-5913	—	18-6293 **
5.7L MIE	GM V-8	1994-1996	F622151	K040306	18-5816	18-5908	18-5908 ①	—	18-5966 ④
5.7L MIE	GM V-8	1994-1996	F622151	K040306	18-5816	18-5907	18-5907 ⑤	—	18-5966 ④
5.7L MIE	GM V-8	1997 & sup	K040307	& sup	18-5817	18-5908	18-5908	—	18-5967
5.7L MIE	GM V-8	1998-01	L002003	L677226	18-5817	18-5908	18-5908	—	18-6293 **
5.7L EFI MIE	GM V-8	1997	K040300	K999999	18-5816	18-5908	18-5908	—	18-5960
5.7L Ski	GM V-8	1985-1995	A338533	F775199	18-5816	—	18-5913 ⑤	—	18-5966 ④
5.7L Ski	GM V-8	1985-1995	A338533	F775199	18-5816	18-5907	18-5907 ①	—	18-5966 ④
5.7L Ski	GM V-8	1996	F775200	K040003	18-5817	—	18-5913	—	18-5966 ④
5.7L Ski	GM V-8	1997	K040004	K999999	18-5817	—	18-5913	—	18-5967
5.7L Ski	GM V-8	1998 & sup	L002005	& sup	18-5817	—	18-5913	—	18-5967
5.7L Ski	GM V-8	2000-01	L619000	L678784	18-5817	—	18-5913	—	18-6293 **
350 Mag. Alpha	GM V-8	1986-1995	A635178	F600999	18-5816 ⑩	18-5910	18-5910 ⑥	—	18-5966 ④
350 Mag. Alpha	GM V-8	1987-1996	B525982	K001526	18-5817 ⑨	18-5910	18-5910 ⑥	—	18-5966 ④
350 Mag. Alpha	GM V-8	1997	K001527	K999999	18-5817	—	18-5913	—	18-5967
350 Mag. EFI & MPI	GM V-8	1995-1996	F415189	K001500	18-5816	—	18-5913	—	18-5965
350 Mag. EFI & MPI	GM V-8	1997 & Sup	K001501	& sup	18-5816	—	18-5913	—	18-5960
350 Mag MPI	GM V-8	2000-01	L619000	M299999	18-5816	—	18-5913	—	18-6293 **
350 Mag MPI / Horizon	GM V-8	2002	M300000	M320024	18-5817	—	18-5913	—	18-6293 **
350 Mag.MPI MIE	GM V-8	1998 & sup	L002008	& sup	18-5816	18-5908	18-5908	—	18-5960
350 Mag MPI MIE / Horizon	GM V-8	1999-01	L304700	L678398	18-5816	18-5908	18-5908	—	18-6293 **
350 Mag Ski	GM V-8	1991-1996	D505450	K040399	18-5816 ⑧	—	18-5913	—	18-5966 ④
350 Mag Ski	GM V-8	1991-1996	D505450	K040399	18-5817 ⑦	—	18-5913	—	18-5966 ④
350 Mag Ski	GM V-8	1997	K040400	K999999	18-5817	—	18-5913	—	18-5967
350 Mag EFI Ski	GM V-8	1994-1997	F215561	K999999	18-5816	—	18-5913	—	18-5965
350 Mag MPI Ski	GM V-8	1995-1996	F350583	F799999	18-5816	—	18-5913	—	18-5965
350 Mag MPI Ski	GM V-8	1998 & sup	L002600	& sup	18-5817	—	18-5913	—	18-5960
350 Mag MPI Ski	GM V-8	1998-02	L002600	M310021	18-5817	—	18-5913	—	18-6293 **
Black Scorpion	GM V-8	1996	F800000	K040000	18-5816	—	18-5913	—	18-5965
Black Scorpion	GM V-8	1997 & sup	K040001	& sup	18-5816	—	18-5913 ⑤	—	18-5960

① Para volante diámetro 12 3/4"
 ② Para volante diámetro 14"
 ③ Modelos c/magneto permanente use 18-5919
 ④ 55 AMP hasta 65 AMP use 18-5965
 ⑤ Negro
 ⑥ Modelos c/magneto permanente use 18-5913
 ⑦ Dirección bravo
 ⑧ Encendido Firepower encendido
 ⑨ Módulo encendido montado en distribuidor
 ⑩ Módulo encendido montado en codo
 ① Rotación izq.
 ② NLA p/modelos anteriores S/N 4167000
 ③ PG 260 (9-1/4" largo)
 ④ PG260F1 (8-1/2" largo)
 ⑤ Rotación derecha
 ⑥ Encendido estándar
 ⑦ Encendido Thunderbolt
 ⑧ Thunderbolt IV
 ⑨ Thunderbolt V
 ⑩ modelos Transmisión Delco Style

Modelo #	Cil.	Años	Desde. S/N	Hasta. S/N	Solenoide	Arranque Remanufact.	Nuevo arranque	Alternador Remanufact.	Nuevo Alternador
Black Scorpion	GM V-8	1997 & Sup	K040001	& Sup	18-5816	—	18-5913 ④	—	18-5960
Black Scorpion	GM V-8	1997-01	K040001	L678036	18-5816	—	18-5913	—	18-6293 **
270 MCM & MIE	GM V-8	1969-1972	2851074	3385720	18-5836	18-5908	18-5908 ①	18-5957	18-5957
270 MCM & MIE	GM V-8	1969-1972	2851074	3385720	18-5836	18-5907	18-5907 ⑤	18-5957	18-5957
280 TRS	GM V-8	1975-1976	4176250	4770199	18-5815	18-5911	18-5911	18-5957	18-5957
300 TR TEMPEST	GM V-8	1985-1986	6668677	B430367	18-5816	18-5908	18-5908	—	18-5966 ④
300 MR TEMPEST	GM V-8	1985-1986	6668677	B430367	18-5816	—	18-5919 ①	—	18-5966 ④
300 MR TEMPEST	GM V-8	1985-1986	6668677	B430367	18-5816	—	18-5913 ②	—	18-5966 ④
320 EFI	GM V-8	1987-1989	A543604	C622418	18-5816	—	18-5913	—	18-5966 ④
MX 6.2L MPI	GM V-8	2000-2002	L680003	M320024	18-5817	—	18-5913	—	18-6293
MX 6.2L MPI Horizon	GM V-8	2002	M300000	M320024	18-5817	—	18-5913	—	18-6293
MX 6.2L MPI Horizon MIE	GM V-8	2002	M300000	M310099	18-5817	—	18-5603	—	18-6293
MX 6.2L MPI MIE	GM V-8	2002	M300000	M310099	18-5817	—	18-5603	—	18-6293
MX 6.2L Black Scorpion Ski	GM V-8	2001	L670015	L678036	18-5816	—	18-5913	—	18-6293
325 MCM & MIE	GM V-8	1968-1970	2278747	2761141	18-5836	18-5908	18-5908 ①	—	—
325 MCM & MIE	GM V-8	1968-1970	2278747	2761141	18-5836	18-5907	18-5907 ⑤	—	—
325 MCM & MIE	GM V-8	1970-1974	2761142	3780449	18-5836	18-5908	18-5908 ①	18-5957	18-5957
325 MCM & MIE	GM V-8	1970-1974	2761142	3780449	18-5836	18-5907	18-5907 ⑤	18-5957	18-5957
330	GM V-8	1977-1981	4623115	6083144	18-5836 ⑦	—	18-5913	18-5957	18-5957
330	GM V-8	1977-1981	4623115	6083144	18-5815 ⑥	—	18-5913	18-5957	18-5957
330	GM V-8	1982-1987	6083145	B816540	18-5816	18-5908	18-5908	—	18-5966 ④
330 MIE	GM V-8	1977-1980	4623115	5889913	18-5836 ⑦	18-5908	18-5908 ①	18-5957	18-5957
330 MIE	GM V-8	1977-1980	4623115	5889913	18-5815 ⑥	18-5907	18-5907 ⑤	18-5957	18-5957
340/7.4L MIE w/BW	GM V-8	1981-1992	5889914	D715493	18-5816	18-5908	18-5908 ①	—	18-5966 ④
340/7.4L MIE w/BW	GM V-8	1981-1992	5889914	D715493	18-5816	18-5907	18-5907 ⑤	—	18-5966 ④
7.4L	GM V-8	1988-1991	B771113	D603117	18-5816	18-5910	18-5910 ⑥	—	18-5966 ④
7.4L	GM V-8	1988-1996	B771113	F800699	18-5816 ⑩	18-5910	18-5910 ⑥	—	18-5966 ④
7.4L	GM V-8	1992-1997	D603118	K999999	18-5817 ⑨	—	18-5913	—	18-5966 ④
7.4LX EFI & MPI	GM V-8	1996-1997	F602010	K999999	18-5816	—	18-5913	—	18-5965
7.4L MPI	GM V-8	1998 & Sup	L010003	& Sup	18-5817	—	18-5913	—	18-6293
7.4L MIE	GM V-8	1989-1996	C391564	F820141	18-5816 ⑧	18-5908	18-5908	—	18-5966 ④
7.4L MIE	GM V-8	1992-1997	D715494	K999999	18-5817 ⑨	18-5908	18-5908	—	18-5966 ④
7.4L EFI & MPI MIE	GM V-8	1995-1997	F563052	K999999	18-5816	18-5908	18-5908	—	18-5965
7.4L MPI MIE	GM V-8	1998 & Sup	L002006	& Sup	18-5817	18-5908	18-5908	—	18-6293
350 MIE	GM V-8	1974-1976	3780450	4623109	18-5836	18-5908	18-5908 ①	18-5957	18-5957
350 MIE	GM V-8	1974-1976	3780450	4623109	18-5836	18-5907	18-5907 ⑤	18-5957	18-5957
370 TRS	GM V-8	1978-1985	4179554	6721527	18-5815	18-5908	18-5908	18-5957	18-5957
370 TRS	GM V-8	1978-1985	4179554	6721527	18-5815	18-5908	18-5908	—	18-5966 ④
370 TRS	GM V-8	1985-1987	6721528	B714586	18-5816	18-5908	18-5908	—	18-5966 ④
390 MCM & MIE	GM V-8	1969-1970	2781129	3042731	18-5836	18-5908	18-5908 ①	18-5957	18-5957
390 MCM & MIE	GM V-8	1969-1970	2781129	3042731	18-5836	18-5907	18-5907 ⑤	18-5957	18-5957
400 TRS	GM V-8	1980-1986	4179554	B457644	18-5815	18-5908	18-5908	18-5957	18-5957
400 TRS	GM V-8	1980-1986	4179554	B457644	18-5815	18-5908	18-5908	—	18-5966 ④
420	GM V-8	1987-1989	A398941	B622418	18-5816	18-5908	18-5908	—	18-5966 ④
425	GM V-8	1990-1992	A398941	D937011	18-5816	18-5908	18-5908	—	18-5966 ④
440 TRS	GM V-8	1983-1986	4179554	B485220	18-5815	18-5908	18-5908	18-5957	18-5957
440 TRS	GM V-8	1983-1986	4179554	B485220	18-5815	18-5908	18-5908	—	18-5966 ④
450	GM V-8	1995-1996	F347100	F347277	18-5820	—	18-5913	—	—
454 Mag.	GM V-8	1986-1994	A631894	F304999	18-5816	—	18-5913	—	18-5966 ④
454 Mag.	GM V-8	1995-1997	F305000	K999999	18-5817	—	18-5913	—	18-5966 ④
454 Mag. MPI	GM V-8	1994-1997	F115700	K999999	18-5816	—	18-5913	—	18-5965
454 Mag. MPI	GM V-8	1998 & Sup	L010029	& Sup	18-5816	—	18-5913	—	18-6293
454 Mag. MPI MIE	GM V-8	1996-1997	F820100	K999999	18-5816	—	18-5913	—	18-5965
454 Mag. MPI MIE	GM V-8	1998 & Sup	L002200	& Sup	18-5816	18-5908	18-5908	—	18-6293
454 EFI Ski	GM V-8	1995-1996	F215800	F820099	18-5816	—	18-5913	—	18-5965
460 TRS	GM V-8	1983-1986	4179554	6181046	18-5815	18-5908	18-5908	18-5957	18-5957
460 TRS	GM V-8	1983-1986	4179554	6181046	18-5815	18-5908	18-5908	—	18-5966 ④
465	GM V-8	1990-1994	C849992	F213244	18-5816 ⑧	—	18-5913 ⑦	—	18-5966 ④ ⑤
465	GM V-8	1990-1994	C849992	F213244	—	18-5908	18-5908 ⑩	—	—
500	GM V-8	1994-1997	F213293	& Sup	18-5820	—	18-5913 ⑦	—	—
500	GM V-8	1994-1995	F213293	& Sup	18-5820	18-5908	18-5908 ⑩	—	—
500 Bulldog	GM V-8	1990-1996	C577254	& Sup	18-5820 ⑧	—	18-5913 ⑦	—	—
500 Bulldog	GM V-8	1990-1996	C577254	& Sup	18-5816 ⑧	18-5908	18-5908 ⑩	—	18-5966 ④ ⑤
502 Mag. Bravo	GM V-8	1990-1993	C878221	F114528	18-5816	—	18-5913	—	18-5966 ④
502 Mag. MPI	GM V-8	1993-1997	D840650	K999999	18-5816	—	18-5913	—	18-5965
502 Mag. MPI	GM V-8	1998 & Sup	L017000	& Sup	18-5816	—	18-5913	—	18-6293
525 SC	GM V-8	1991-1993	D456000	D763831	18-5816	—	18-5913 ⑦	—	18-5966 ④ ⑤
525 SC	GM V-8	1991-1993	D456000	D763831	18-5816	18-5908	18-5908 ⑩	—	—
525 SC	GM V-8	1993-1997	D763871	& Sup	18-5820	—	18-5913 ⑦	—	18-5966 ④ ⑤
525 SC	GM V-8	1993-1997	D763871	& Sup	18-5820	18-5908	18-5908 ⑩	—	—
525 EFI	GM V-8	2003-2010	M900146	& Sup	—	—	—	—	18-6298
575	GM V-8	1986-1992	A677429	D763716	18-5816	18-5908	18-5908	—	18-5966 ④
600 SC	GM V-8	1991-1996	D456489	F877642	18-5816 ⑧	18-5908	18-5908	—	18-5966 ④ ⑤
600 SC	GM V-8	1991-1996	D456489	F877642	18-5820 ⑧	18-5908	18-5908	—	—
600 SC	GM V-8	1997	K000227	& Sup	18-5820	—	18-5913 ⑩	—	—
600 Sci	GM V-8	2005-2010	M952908	& Sup	—	—	—	—	18-6298
800 SC	GM V-8	1993-1996	D763836	& Sup	18-5820	18-5908	18-5908 ⑩	—	—
8.2L MIE	GM V-8	1990-1996	C878221	F819619	18-5816 ⑧	18-5908	18-5908	—	18-5966 ④
8.2L MIE	GM V-8	1993-1996	D857200	F819619	18-5817	18-5908	18-5908	—	18-5966 ④
8.2L MPI MIE	GM V-8	1996-1997	F819620	K999999	18-5816	18-5908	18-5908	—	18-5965
8.2L MPI MIE	GM V-8	1998 & Sup	L002450	& Sup	18-5816	18-5908	18-5908	—	18-6293

① Para volante diámetro 12 3/4"

② Para volante diámetro 14"

③ Modelos c/magneto permanente use 18-5919

④ 55 AMP hasta 65 AMP use 18-5965

⑤ Negro

⑥ Modelos c/magneto 18-5913

⑦ Dirección Bravo

⑧ Encendido Firepower

⑨ Modulo encendido montado en distribuidor

⑩ Modulo encendido montado en codo

⑪ Rotación izq.

⑫ NLA p/modelos anteriores S/N 4167000

⑬ PG 260 (9-1/4" largo)

⑭ PG260F1 (8-1/2" largo)

⑮ Rotación derecha

⑯ Encendido estándar

⑰ Encendido Thunderbolt

⑱ Thunderbolt IV

⑲ Thunderbolt V

⑳ Modelos transmisión

** Delco Style



18-7683
REGULADOR DE PRESIÓN COMBUSTIBLE
Reemplaza: 849899
Para: MCM 500 EFI



18-7663
REGULADOR DE PRESIÓN COMBUSTIBLE
Reemplaza: 802630T01, 802630001, 802630T, 802630, 8M0069803
7.4L MPI (L29)



18-33207
REGULADOR DE PRESIÓN COMBUSTIBLE
Reemplaza: 860349A1
Para: MCM/MIE 7.4L/LX MPI, 4545 Mag MPI, 502 Mag MPI, MIE 8.2L MPI.



18-33211
REGULADOR DE PRESIÓN COMBUSTIBLE
Reemplaza: 892681
Para: Mercruiser 8.1L, 496 Mag HO, 502 Mag MPI 375-400 HP.



18-7600
SENSOR DE TEMPERATURA
Reemplaza: 805218T



18-7700
SENSOR POSICIÓN ACELERADOR
Reemplaza: 853678T
Para: MCM/MIE 4.3L MPI, 5.0L MPI, MX6.2L MPI w/ECM 555 and 350 Mag MPI, Black Scorpion Tow Sports, 377 Scorpion Tow Sports, 7.4L MPI(L29) & MCM 496 Mag & HO y MIE 8.1S & HO



18-7630
SENSOR POSICIÓN ACELERADOR
Reemplaza: 805226A1



18-7701
CONTROL MOTOR
Reemplaza: 862998
Para: MCM 3.0L MPI, V6 & V8(305, 350 & 496 cid) MPI motores con ECM555 (Incluye juntas)



18-7697
IAC MOTOR
Reemplaza: 803149
Para: MCM/MIE 350 Mag MPI, Black Scorpion Tow Sports, 377 Scorpion MCM & Tow Sports, MX6.2L MPI, 7.4L MPI(L29) & 575 Sci



18-7632
CONTROL MOTOR RELANTI
Reemplaza: 805224A1



18-33800
PCV VÁLVULA
Reemplaza: 21-806118
Para: MCM 262 Mag EFI, 4.3L EFI



18-7682
SENSOR DE PICADO
Reemplaza: 849934, 879150150
Para: MCM 575 Sci



18-7684
SENSOR DE PICADO
Reemplaza: 864856A1, 805217A1
Para: MCM/MIE GM V6 & V8 (350, 377, 454 & 502cid)EFI



18-7660
SENSOR DE PICADO
Reemplaza: 881731, 8M0054726
V-6 & V-8 MPI motores con 555 ECM



18-7550
SENSOR DE PICADO
Reemplaza: 861249, 861249A1
Para: MERCURY 5.7L, 7.4L 1998-2001



18-7551
SENSOR MAP
Reemplaza: 861425
Para: Mercury Scorpion,
Escorpión negro 1998-2010



18-7668
MAP SENSOR
Reemplaza: 854445
525 EFI



18-7553
SENSOR DE GOLPE
Replaces: 808015T
Para: Mercury 5.7L MAG 1998-2010



18-7554
SENSOR DE GOLPE
Reemplaza: 878187
Para: Mercury 5.7L MAG 1994-2010



18-7677
SENSOR DE GOLPE
Reemplaza: 806612T
Para: GM V8(305, 350 & 377 cid)



18-7703
SENSOR DE GOLPE
Reemplaza: 805544T



18-7646
SENSOR ARBOL DE LEVAS
Reemplaza: 892615002, 892615001,
862615



18-7685
INYECTOR TBI
Reemplaza: 852956A1
Para: MCM GM V6 & V8 (305 & 350
cid) motores TBI



18-7757
**SENSOR POSICIÓN ACELERA-
DOR** Reemplaza: 803148
Para: 350 Mag OL005900 & sup



18-33104
INYECTOR COMBUSTIBLE
Reemplaza: 802632T, 802632
Para: MCM/MIE 7.4L MPI L29



18-7688
INYECTOR COMBUSTIBLE
Reemplaza: 885176
Para: Motores MCM 4.3L MPI (s/n OM300000-1A063239)
& 5.0L, 5.7L & 6.2L MPI motores con ECM 555
(s/n OM300000-1A064824)



18-7698
INYECTOR COMBUSTIBLE
Reemplaza: 881693002
Para: MCM 496 Mag & HO y MIE 8.1S & HO

18-7690
KIT RETÉN INYECTOR
Use con inyector Mercury
852956A1, 853998A1, 853998T, 853998
Para: 262 Mag EFI (1996-97), 4.3L EFI (1998-01), 5.0L
EFI (1998-01), 350 Mag Alpha EFI (Gen+) (1996-97), 350
Mag EFI SKI (1994-97), 5.7L EFI (1995-01), 5.7L EFI MIE
(Gen+) (1997), 5.7L LX Bravo EFI (Gen+) (1996-97), 5.7 LX
EFI (1995-97), 7.4L LX TBI (1996-97), 575 Sci (2000-05)

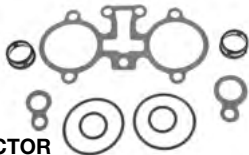

18-7691
KIT RETÉN INYECTOR
Use con Mercury Injector # 806807A1
Para: 350 Mag Bravo MPI (1995-96), Black Scorpion
SKI (1996)



18-7692
KIT RETÉN INYECTOR
Use con inyector Mercury # 861260T, 861260
Para: 350 Mag MPI(98-01), 350 Mag MPI Horizon MIE(99-01), 350 Mag MPI MIE(98-01), 350 Mag MPI SKI(98-01),
MX 6.2L MPI(00-01), 454 Mag MPI(99-01), 454 Mag MPI
Horizon MIE(99-01), 502 Mag MPI(99-01), 8.2L MPI(99-01)



18-7693
KIT RETÉN INYECTOR
Use con inyector Mercury # 802632T, 849896
Para: 7.4L MPI(L29)(98-01), 7.4L MPI MIE(L29)(98-01), 500 EFI(99-05)



18-7694
KIT RETÉN INYECTOR
Use con inyector Mercury # 881693002
Para: 496 Mag (2001-08), 496 Mag DTS (2001-08), 496 Mag HO (2001-08), 496 Mag HO
DTS (2001-08), 8.1L MIE (2001-08), 496 Mag DTS (2001-08), 8.1L HO MIE (2001-08), 496
Mag HO DTS (2001-08)



18-7695
KIT RETÉN INYECTOR
Use con inyector Mercury # 885176
Para: 4.3L MPI(02-08), 5.0L MPI(02-08), 5.0L MPI DTS(05-08), 350 Mag MPI(02-08), 350
Mag MPI DTS(05-08), 350 Mag MPI Horizon(02-07), 350 Mag MPI Horizon DTS(05-07), 350
Mag MPI Horizon MIE(02-07), 350 Mag Horizon MIE DTS(05-07), 350 Mag MPI MIE(02-07),
350 Mag MPI MIE DTS(05-07), 350 Mag MPI SKI(02-07), 5.7L Horizon MIE(08), 5.7L MIE(08),
5.7L DTS MIE(08), 5.7L MPI SKI(08), MX6.2L MPI(02-07), MX6.2L MPI DTS(05-07), MX6.2L
MPI Horizon(04-07), MX6.2L MPI Horizon DTS(05-07), MX6.2L MPI Horizon MIE(02-08),
MX6.2L MPI Horizon MIE DTS(05-08), MX 6.2L MPI MIE(02-07), MX6.2L MPI MIE DTS(05-07),
MX6.2L MPI SKI(02-07)



18-7696
KIT RETÉN INYECTOR
Use con inyector Mercury # 805225A1
Para: 320 EFI(87-89), 350 Mag Bravo MPI(Gen+)(97), negro Scorpion Ski(97-08), 377
Scorpion MCM(99-05), 377 Scorpion Ski(97-98), MX6.2L Black Scorpion Ski (01-07),
454 Mag EFI SKI(94-97), 454 Mag MPI(96-98), 454 Mag MPI Horizon MIE(98), 7.4L MPI
MIE(95-97), 7.4LX MPI(96-97), 502 Mag MPI(93-98), 525 EFI(03-08), 8.2L MPI MIE(96-98)



Aplicaciones Sistema inyección combustible

Modelo	Litros	CiD	# Cil	Intervalo de años	rango de serie	Inyector	IAC Válvula	TPS	F/P regulador montados en riel	F/P Refrigerador regular montado	Sensor de picado
3.0L MPI	3.0L	181	L4	2008-2010	A072812 & SUP	N/D	18-7701	N/D	N/D	N/D	N/D
262 MAG EFI	4.3L	262	V-6	1996-1997	F803800 - K999999	18-7685	18-7632	18-7630	N/D	N/D	18-7684
4.3L EFI	4.3L	262	V-6	1998-2001	L012009 - M299999	18-7685	18-7632	18-7630	N/D	N/D	N/D
4.3L MPI	4.3L	262	V-6	2002-2007	M300000 - A063239	18-7688	18-7701	18-7700	N/D	N/D	N/D ②
4.3L MPI	4.3L	262	V-6	2007-2010	A063240 & SUP	N/D	18-7701	18-7700	N/D	N/D	N/D ②
5.0L EFI	5.0L	305	V-8	1998-2001	L012052 - M299999	18-7685	18-7632	18-7630	N/D	N/D	N/D
5.0L MPI	5.0L	305	V-6	2002-2007	M300000 - A064824	18-7688	18-7701	18-7700	N/D	N/D ①	N/D ②
5.0L MPI	5.0L	305	V-6	2007-2010	A064825 & SUP	N/D	18-7701	18-7700	N/D	N/D ①	N/D ②
5.0L MPI DTS	5.0L	305	V-8	2005-2007	W310000 - A064824	18-7685	N/D	N/D	N/D	N/D	N/D
5.0L MPI DTS	5.0L	305	V-8	2010	A064825 & SUP	N/D	N/D	N/D	N/D	N/D	N/D
350 MAG ALPHA EFI (GEN +)	5.7L	350	V-8	1996-1997	F800300 - K999999	18-7685	18-7632	18-7630	N/D	N/D	18-7684
350 MAG BRAVO MPI	5.7L	350	V-8	1995-1996	F415189 - K001500	N/D	18-7632	18-7630	N.L.A.	N/D	18-7684 ②
350 MAG BRAVO MPI (GEN +)	5.7L	350	V-8	1997	K001501 - K999999	N/D	18-7632	18-7630	N/D	N/D	18-7684 ②
350 MAG EFI SKI	5.7L	350	V-8	1994-1996	F215561 - F820706	18-7685	18-7632	18-7630	N/D	N/D	18-7684
350 MAG EFI SKI	5.7L	350	V-8	1996	F820707 - K040005	18-7685	18-7632	18-7630	N/D	N/D	18-7684
350 MAG MPI	5.7L	350	V-8	1998	L010019 - L331598	N/D	18-7697	18-7700	N/D	N/D	N/D
350 MAG MPI	5.7L	350	V-8	1998	L336000 - L346999	N/D	18-7697	18-7700	N/D	N/D	N/D
350 MAG MPI	5.7L	350	V-8	1999	L331599 - L335999	N/D	18-7697	18-7757	N/D	N/D	N/D
350 MAG MPI	5.7L	350	V-8	1999-2001	L340000 - M299999	N/D	18-7697	18-7757	N/D	N/D	N/D
350 MAG MPI	5.7L	350	V-8	2002-2007	M300000 - A064824	18-7688	18-7701	18-7700	N/D	N/D ①	N/D ②
350 MAG MPI DTS	5.7L	350	V-8	2005-2007	W310000 - A064824	18-7688	N/D	N/A	N/D	N/D	N/D ②
350 MAG MPI DTS	5.7L	350	V-8	2007-2010	A064825 & SUP	N/D	N/D	N/A	N/D	N/D	N/D ②
350 MAG MPI HORIZON	5.7L	350	V-8	2002-2007	M300000 - A064824	18-7688	18-7701	18-7700	N/D	N/D ①	N/D ②
350 MAG MPI HORIZON	5.7L	350	V-8	2007	A064825 - A299999	N/D	18-7701	18-7700	N/D	N/D ①	N/D ②
350 MAG MPI HORIZON DTS	5.7L	350	V-8	2005-2007	W310000 - A064824	18-7688	N/D	N/A	N/D	N/D	N/D ②
350 MAG MPI HORIZON DTS	5.7L	350	V-8	2007	A064825 - A299999	N/D	N/D	N/A	N/D	N/D	N/D ②
350 MAG MPI HORIZON MIE	5.7L	350	V-8	1999-2001	L304700 - M299999	N/D	18-7697	18-7757	N/D	N/D	N/D
350 MAG MPI HORIZON MIE	5.7L	350	V-8	2002-2004	M300000 - M398371	18-7688	18-7701	18-7700	N/D	N/D	N/D ②
350 MAG MPI HORIZON MIE	5.7L	350	V-8	2004-2007	M398372 - A064824	18-7688	18-7701	18-7700	N/D	N/D	N/D ②
350 MAG MPI HORIZON MIE	5.7L	350	V-8	2007	A064825 - A089999	N/D	18-7701	18-7700	N/D	N/D	N/D ②
350 MAG MPI HORIZON MIE DTS	5.7L	350	V-8	2005-2007	W390000 - A064824	18-7688	N/D	N/A	N/D	N/D	N/D ②
350 MAG MPI HORIZON MIE DTS	5.7L	350	V-8	2007	A064825 - A089999	N/D	N/D	N/A	N/D	N/D	N/D ②
350 MAG MPI MIE	5.7L	350	V-8	1998	L002008 - L302199	N/D	18-7697	18-7700	N/D	N/D	N/D
350 MAG MPI MIE	5.7L	350	V-8	1999-2001	L302200 - M299999	N/D	18-7697	18-7757	N/D	N/D	N/D
350 MAG MPI MIE	5.7L	350	V-8	2002-2004	M300000 - M398371	18-7688	18-7701	18-7700	N/D	N/D	N/D ②
350 MAG MPI MIE	5.7L	350	V-8	2004-2007	M398372 - A064824	18-7688	18-7701	18-7700	N/D	N/D	N/D ②
350 MAG MPI MIE	5.7L	350	V-8	2007	A064825 - A089999	N/D	18-7701	18-7700	N/D	N/D	N/D ②
350 MAG MPI HORIZON MIE DTS	5.7L	350	V-8	2005-2007	W390000 - A064824	18-7688	N/D	N/A	N/D	N/D	N/D ②
350 MAG MPI HORIZON MIE DTS	5.7L	350	V-8	2007	A064825 - A089999	N/D	N/D	N/A	N/D	N/D	N/D ②
350 MAG MPI MIE DTS	5.7L	350	V-8	1998	L002008 - L302199	N/D	18-7697	18-7700	N/D	N/D	N/D
350 MAG MPI MIE DTS	5.7L	350	V-8	1999-2001	L302200 - M299999	N/D	18-7697	18-7757	N/D	N/D	N/D
350 MAG MPI MIE	5.7L	350	V-8	2002-2004	M300000 - M398371	18-7688	18-7701	18-7700	N/D	N/D	N/D ②
350 MAG MPI MIE	5.7L	350	V-8	2004-2007	M398372 - A064824	18-7688	18-7701	18-7700	N/D	N/D	N/D ②
350 MAG MPI MIE	5.7L	350	V-8	2007	A064825 - A089999	N/D	18-7701	18-7700	N/D	N/D	N/D ②
350 MAG MPI MIE DTS	5.7L	350	V-8	2005-2007	W390000 - A064824	18-7688	N/D	N/A	N/D	N/D	N/D ②
350 MAG MPI MIE DTS	5.7L	350	V-8	2007	A064825 - A089999	N/D	N/D	N/A	N/D	N/D	N/D ②
350 MAG EFI SKI	5.7L	350	V-8	1994-1996	F215561 - F820706	18-7685	18-7632	18-7630	N/D	N/D	18-7684
350 MAG MPI SKI	5.7L	350	V-8	1998	L002600 - L304599	N/D	18-7697	18-7700	N/D	N/D	N/D
350 MAG MPI SKI	5.7L	350	V-8	1999-2001	L304600 - M299999	N/D	18-7697	18-7757	N/D	N/D	N/D
350 MAG MPI SKI	5.7L	350	V-8	2002-2007	M300000 - A064824	N/D	18-7701	18-7700	N/D	N/D	N/D ②

① BRAVO APPS W/SN W060000, PIDE REGULADOR # 892681 ② MAPA SENSOR (TEMP & PRESIÓN)

Modelo	Litro	CID	# Cil	Intervalo de años	Rango de serie	Inyector	IAC Válvula	TPS	F/P Regulador montados en riel	F/P Refrigerador Regular montado	Sensor de picado
350 MAG MPI SKI	5.7L	350	V-8	2007	A064825 - A089999	N/D	18-7701	18-7700	N/D	N/D	N/D
5.7L EFI	5.7L	350	V-8	1995-1997	F225560 - K999999	18-7685	18-7632	18-7630	N/D	N/D	18-7684
5.7L EFI (GEN +)	5.7L	350	V-8	1998-2001	L010035 - M299999	18-7685	18-7632	18-7630	N/D	N/D	N/D
5.7L EFI MIE (GEN +)	5.7L	350	V-8	1997	K040300 - K999999	18-7685	18-7632	18-7630	N/D	N/D	18-7684
5.7L MPI HORIZON MIE	5.7L	350	V-8	2008-2010	A090000 - & SUP	N/D	18-7701	18-7700	N/D	N/D	N/D
5.7L MPI HORIZON DTS MIE	5.7L	350	V-8	2008-2010	A090000 - & SUP	N/D	N/D	N/D	N/D	N/D	N/D
5.7L MPI MIE	5.7L	350	V-8	2008-2010	A090000 - & SUP	N/D	18-7701	18-7700	N/D	N/D	N/D
5.7L MPI DTS MIE	5.7L	350	V-8	2008-2010	A090000 - & SUP	N/D	N/D	N/D	N/D	N/D	N/D
5.7L MPI SKI	5.7L	350	V-8	2008-2010	A090000 - & SUP	N/D	N/D	18-7700	N/D	N/D	N/D
5.7LX BRAVO EFI (GEN +)	5.7L	350	V-8	1996-1997	F800300 - K999999	18-7685	18-7632	18-7630	N/D	N/D	18-7684
5.7LX EFI	5.7L	350	V-8	1995-1997	F225560 - K999999	18-7685	18-7632	18-7630	N/D	N/D	18-7684
BLACK SCORPION SKI		350	V-8	1996	F350583 - K040000	N/D	18-7697	18-7700	N.L.A.	N.L.A.	18-7684
BLACK SCORPION SKI		350	V-8	1997	K040001 - L002699	N/D	18-7697	18-7700	N/D	N/D	18-7684
BLACK SCORPION SKI		350	V-8	1998	L002700 - L005600	N/D	18-7697	18-7700	N/D	N/D	N/D
BLACK SCORPION SKI		350	V-8	1998-2002	L005601 - M391599	N/D	18-7697	18-7757	N/D	N/D	N/D
BLACK SCORPION SKI		350	V-8	2003-2010	M391600 - W698432	N/D	18-7701	18-7757	N/D	N/D	N/D
SCORPION 350	5.0L	350	V-8	2008-2010	W698433 & SUP	N/D	18-7701	18-7757	N/D	N/D	N/D
377 MAG		377	V-8	2008-2010	A300000 & SUP	N/D	18-7701	18-7700	N/D	N/D	N/D
377 MAG DTS		377	V-8	2008-2010	A300000 & SUP	N/D	N/D	N/D	N/D	N/D	N/D
377 SCORPION MCM		377	V-8	1999-2005	L416146 - M907201	N/D	18-7697	18-7757	N/D	N/D	18-7684
377 SCORPION SKI		377	V-8	1997-1998	K000656 - L600314	N/D	18-7697	18-7700	N/D	N/D	18-7684
MX 6.2L MPI	6.2L	377	V-8	2000-2001	L680003 - M299999	N/D	18-7697	18-7757	N/D	N/D	N/D
MX 6.2L MPI	6.2L	377	V-8	2002-2004	M300000 - W059999	18-7688	18-7701	18-7700	N/D	N/D	N/D
MX 6.2L MPI	6.2L	377	V-8	2004-2007	W060000 - A064824	18-7688	18-7701	18-7700	N/D	N/D	N/D
MX 6.2L MPI	6.2L	377	V-8	2007	A064825 - A299999	N/D	18-7701	18-7700	N/D	N/D	N/D
MX 6.2L MPI DTS.	6.2L	377	V-8	2005-2007	W310000 - A064824	18-7688	N/D	N/D	N/D	N/D	N/D
MX 6.2L MPI DTS.	6.2L	377	V-8	2007	A064825 - A299999	N/D	N/D	N/D	N/D	N/D	N/D
MX 6.2L MPI HORIZON	6.2L	377	V-8	2002-2004	M300000 - W059999	18-7688	18-7701	18-7700	N/D	N/D	N/D
MX 6.2L MPI HORIZON	6.2L	377	V-8	2004-2007	W060000 - A064824	18-7688	18-7701	18-7700	N/D	N/D	N/D
MX 6.2L MPI HORIZON	6.2L	377	V-8	2007	A064825 - A299999	N/D	18-7701	18-7700	N/D	N/D	N/D
MX 6.2L MPI HORIZON DTS	6.2L	377	V-8	2005-2007	W310000 - A064824	18-7688	N/D	N/D	N/D	N/D	N/D
MX 6.2L MPI HORIZON DTS	6.2L	377	V-8	2007	A064825 - A299999	N/D	N/D	N/D	N/D	N/D	N/D
MX 6.2L MPI HORIZON MIE	6.2L	377	V-8	2002-2004	M300000 - M398394	18-7688	18-7701	18-7700	N/D	N/D	N/D
MX 6.2L MPI HORIZON MIE	6.2L	377	V-8	2004-2007	M398395 - A064825	18-7688	18-7701	18-7700	N/D	N/D	N/D
MX 6.2L MPI HORIZON MIE	6.2L	377	V-8	2007-2010	A064825 & SUP	N/D	18-7701	18-7700	N/D	N/D	N/D
MX 6.2L MPI HORIZON MIE DTS	6.2L	377	V-8	2005-2007	W390000 - A064824	18-7688	N/D	N/D	N/D	N/D	N/D
MX 6.2L MPI HORIZON MIE DTS	6.2L	377	V-8	2007-2010	A064825 & SUP	N/D	N/D	N/D	N/D	N/D	N/D
MX 6.2L MPI MIE	6.2L	377	V-8	2002-2004	M300000 - M398394	18-7688	18-7701	18-7700	N/D	N/D	N/D
MX 6.2L MPI MIE	6.2L	377	V-8	2004-2007	M398395 - A064825	18-7688	18-7701	18-7700	N/D	N/D	N/D
MX 6.2L MPI MIE	6.2L	377	V-8	2007-2010	A064825 & SUP	N/D	18-7701	18-7700	N/D	N/D	N/D
MX 6.2L MPI MIE DTS	6.2L	377	V-8	2005-2007	W390000 - A064824	18-7688	N/D	N/D	N/D	N/D	N/D
MX 6.2L MPI MIE DTS	6.2L	377	V-8	2007-2010	A064825 & SUP	N/D	N/D	N/D	N/D	N/D	N/D
MX 6.2L MPI SKI	6.2L	377	V-8	2002-2007	M317000 - W689999	18-7688	18-7701	18-7700	N/D	N/D	N/D
MX 6.2L BLACK SCORPION SKI	6.2L	377	V-8	2001-2003	L005601 - M391599	N/D	18-7697	18-7757	N/D	N/D	N/D
MX 6.2L BLACK SCORPION SKI	6.2L	377	V-8	2003-2007	M391750 - W698432	N/D	18-7701	18-7757	N/D	N/D	N/D
454 MAG EFI	7.4L	454	V-8	1994-1996	F115700 - F802349	N/D	18-7632	18-7630	N/D	N/D	18-7684
454 MAG EFI SKI	7.4L	454	V-8	1995-1996	F215800 - F820099	N/D	18-7632	18-7630	N/D	N/D	18-7684
454 MAG EFI SKI	7.4L	454	V-8	1996-1997	F820099 - K999999	N/D	18-7632	18-7630	N/D	N/D	18-7684
454 MAG MPI	7.4L	454	V-8	1996-1997	F802350 - K147349	N/D	18-7632	18-7630	N/D	N/D	18-7684
454 MAG MPI	7.4L	454	V-8	1997-1998	K147350 - L085399	N/D	18-7632	18-7630	N/D	N/D	18-7684
454 MAG MPI	7.4L	454	V-8	1999-2001	L085400 - M024999	N/D	18-7632	18-7630	N/D	N/D	18-7684
454 MAG MPI HORIZON MIE	7.4L	454	V-8	1998	L002200 - L086049	N/D	18-7632	18-7630	N/D	N/D	18-7684
454 MAG MPI HORIZON MIE	7.4L	454	V-8	1999-2001	L086050 - L674000	N/D	18-7632	18-7630	N/D	N/D	18-7684
7.4L MPI (L29)	7.4L	454	V-8	1998-2001	L010003 - M024330	N/D	18-7697	18-7700	18-7663	N/D	N/D
7.4L MPI MIE	7.4L	454	V-8	1995-1996	F563052 - K147349	N/D	18-7632	18-7630	N/D	N/D	18-7684
7.4L MPI MIE	7.4L	454	V-8	1997	K147350 - K999999	N/D	N/D	18-7630	N/D	N/D	18-7684
7.4L MPI MIE (L29)	7.4L	454	V-8	1998-2001	L010003 - L674613	N/D	N/D	18-7700	18-7663	N/D	N/D
7.4LX TBI	7.4L	454	V-8	1996-1997	F820000 - K999999	N.L.A.	18-7632	18-7630	N/D	N/D	18-7684
7.4LX MPI	7.4L	454	V-8	1996	F602010 - K147349	N/D	18-7632	18-7630	N/D	N/D	18-7684
7.4LX MPI	7.4L	454	V-8	1997	K147350 - K999999	N/D	18-7632	18-7630	N/D	N/D	18-7684
496 MAG		496	V-8	2001-2004	M025000 - W059999	N/D	N/D	18-7700	18-7663	N/D	N/D
496 MAG		496	V-8	2004	W060000 - W060573	N/D	N/D	18-7700	18-7663	N/D	N/D
496 MAG		496	V-8	2004-2010	W060574 - & SUP	N/D	N/D	18-7700	N/D	N/D	N/D
496 MAG DTS		496	V-8	2001-2004	M025000 - W059999	N/D	N/D	N/D	18-7663	N/D	N/D
496 MAG DTS		496	V-8	2004	W060000 - W060573	N/D	N/D	N/D	18-7663	N/D	N/D
496 MAG HO		496	V-8	2001-2004	M025000 - W059999	N/D	N/D	18-7700	18-7663	N/D	N/D
496 MAG HO		496	V-8	2004	W060000 - W060461	N/D	N/D	18-7700	18-7663	N/D	N/D
496 MAG HO		496	V-8	2004-2010	W060462 - & SUP	N/D	N/D	18-7700	N/D	N/D	N/D
496 MAG HO DTS		496	V-8	2001-2004	M025000 - W059999	N/D	N/D	N/D	18-7663	N/D	N/D
496 MAG HO DTS		496	V-8	2004	W060000 - W060461	N/D	N/D	N/D	18-7663	N/D	N/D
496 MAG HO DTS		496	V-8	2004-2010	W060462 - & SUP	N/D	N/D	N/D	N/D	N/D	N/D
496 MAG & HO EC		496	V-8	2007-2010	A066166 & SUP	N/D	N/D	18-7700	N/D	N/D	N/D
496 MAG & HO DTS EC		496	V-8	2010		N/D	N/D	N/D	N/D	N/D	N/D
8.1L & HO MIE		496	V-8	2001-2004	M026000 - W089999	N/D	N/D	18-7700	18-7663	N/D	N/D
8.1L & HO MIE		496	V-8	2004	W090000 - W389999	N/D	N/D	18-7700	18-7663	N/D	N/D
8.1L & HO MIE		496	V-8	2004-2010	W390000 - & SUP	N/D	N/D	18-7700	N/D	N/D	N/D
8.1L & HO MIE DTS		496	V-8	2001-2004	M026000 - W089999	N/D	N/D	N/D	18-7663	N/D	N/D
8.1L & HO MIE DTS		496	V-8	2004	W090000 - W389999	N/D	N/D	N/D	18-7663	N/D	N/D
8.1L & HO MIE EC		496	V-8	2007-2010	W697154 - & SUP	N/D	N/D	18-7700	N/D	N/D	N/D
500 EFI	8.2L	502	V-8	1999-2005	L001477 - M907127	N/D	18-7632	N/D	N/D	N/D	18-7684
502 MAG MPI	8.2L	502	V-8	1993-1996	D840650 - K147349	N/D	18-7632	18-7630	N/D	N/D	18-7684
502 MAG MPI	8.2L	502	V-8	1997-1998	K147350 - L085432	N/D	18-7632	18-7630	N/D	N/D	18-7684
502 MAG MPI	8.2L	502	V-8	1999-2001	L085432 - M024999	N/D	18-7632	18-7630	N/D	N/D	18-7684
575 Sci	8.2L	502	V-8	2000-2005	L306696 - M950526	N.L.A.	18-7632	18-7630	N/D	N/D	N/D
575 Sci	8.2L	502	V-8	2000-2005	L306696 - M950526	N.L.A.	18-7632	18-7630	N/D	N/D	N/D
8.2L MAG	8.2L	502	V-8	2010	A350340 & SUP	N/D	N/D	18-7700	N/D	N/D	N/D
8.2L MIE	8.2L	502	V-8	2010	A350340 & SUP	N/D	N/D	18-7700	N/D	N/D	N/D
8.2L MPI MIE	8.2L	502	V-8	1996	F819620 - K147349	N/D	18-7632	18-7630	N/D	N/D	18-7684
8.2L MPI MIE	8.2L	502	V-8	1997-1998	K127350 - L086012	N/D	18-7632	18-7630	N/D	N/D	18-7684
8.2L MPI MIE	8.2L	502	V-8	1999-2001	L086013 - L674200	N/D	18-7632	18-7630	N/D	N/D	18-7684

TODOS LOS CARBURADORES SIERRA INCLUYEN JUNTA BASE

- Precisión remanufacturada para alcanzar o exceder las especificaciones OEM
- Recalibrados y reprogramados para maximizar la eficiencia y rendimiento del combustible
- Prueba de flujo por todas partes del regulador a todos los carburadores
- La mezcla de combustible y ajustes ociosos son predeterminados para asegurar que sólo el menos ocioso y ajustes de estrangulador son necesarios durante la instalación
- Todas las bases son revesadas de nuevo y los manguitos del eje regulador sustituidos

Sistema combustible
MERCURISER



**18-7370N
CARBURADOR**
Reemplaza: 3310-860070A2,
3310-806077A2, 3310-
806078A2, 1389-9562A1,
1389-9350A2, 1389-8490A2,
1389-815396A2
Para: MCM 120/2.5L & 140/3.0L



**18-7373N
MERCARB 2V CARBURADOR**
Reemplaza:
Mercruiser 3310-864941A01
2002-2004 4.3L
(s/n OM615000-OW300012
Use kit carb 18-7098-1



**18-7375N
CARBURADOR**
Reemplaza: 3310-864942A01,
3310-861448A1
Para: 1998-2004 MCM 5.0L



**18-7376N
CARBURADOR**
Reemplaza: 3310-864943A01,
3310-861245A1
Para: 1998 y nuevos 5.7L aplicaciones



**18-7615N
CARBURADOR Q-JET**
Reemplaza: 1347-816373A4,
1347-804624R1,
1347-804624R02
Use kit carb 18-7095



**18-7639
CARBURADOR**
Reemplaza: 3310-864943A01,
86125A1
Mercarb-5.7L 2V 1998 y nuevos 5.7L
(OL010337-OW300754) & 5.7L MIE
(OL002003-OW090899)
(Remanufacturado)
Use kit carb 18-7098-1 & junta 18-0994



**18-7640
CARBURADOR**
Q-jet universal con inductor eléctrico
(Remanufacturado)
Use kit carb 18-7095 & junta 18-0994



**18-7603-1
CARBURADOR**
2 cuerpos - Rochester
Reemplaza: 1347-818622,
1376-5659A1, 1347-818622 1,
1347-818622R02
(Remanufacturado)
Use kit carb 18-7075 & junta 18-0994 (izq)
& 18-0434 (derecha)



**18-7604-1
CARBURADOR**
4 cuerpos - Rochester
Reemplaza: 3304-9354A2,
1347-804623R02, 1347-804623R1
(Remanufacturado)
Use kit carb 18-7095 & junta 18-2648



**18-7605-1
CARBURADOR**
4 cuerpo - Rochester
Reemplaza: 1347-9661A3,
1347-804623A1,
1347-804623R02
(Remanufacturado)
Use kit carb 18-7095 & junta 18-2648



**18-7608-1
CARBURADOR**
2 cuerpos - Rochester
Reemplaza: 1347-818620,
1347-818620 1, 1347-818620R02
(Remanufacturado)
Use kit carb 18-7070 & junta 18-0356



**18-7609-1
CARBURADOR**
2 cuerpos - Rochester
Reemplaza: 1347-818619,
1347-818619 1, 1347-818619 1R
(Remanufacturado)
Use kit carb 18-7070 & junta 18-0356



**18-7610-1
CARBURADOR**
2 cuerpos - Rochester
Reemplaza: 1347-818621,
1347-818621 1, 1347-818621 1R02
(Remanufacturado)
Use kit carb 18-7070 & junta 18-0396



**18-7611-2
CARBURADOR**
2 cuerpos - Rochester
Reemplaza: 3310-807312A1,
3310-807312R02
(Remanufacturado)
Use kit carb 18-7097 & junta 18-0994



**18-7613-1
CARBURADOR**
4 cuerpos - Carter (Weber)
Reemplaza: 3310-806969A1,
3310-806969R01
(Remanufacturado)
Use junta 18-0467



**18-7615-1
CARBURADOR**
4 cuerpos - Rochester
Reemplaza: 1347-816373A4,
1347-804624R1, 1347-804624R02
(Remanufacturado)
Use Carb Kit 18-7095 & junta 18-2548



**18-7616-1
CARBURADOR**
4 cuerpos - Rochester
Reemplaza: 1347-8288A1,
1347-804626R02
(Remanufacturado)
Use kit carb 18-7072 & junta 18-2848



**18-7617-1
CARBURADOR**
4 Barrel - Rochester
Reemplaza: 1347-9863A3,
1347-804624R1, 1347-804625R02
(Remanufacturado)
Use kit carb 18-7095 & junta 18-2848

TODOS LOS CARBURADORES SIERRA INCLUYEN JUNTA BASE

18-7618-1
CARBURADOR
 4 cuerpos - Rochester
 Reemplaza: 1347-8289A1,
 1347-804624R1, 1347-804624R02
(Remanufacturado)
 Use kit carb 18-7095 & junta 18-2848



18-7619-1
CARBURADOR
 4 cuerpos - Rochester
 Reemplaza: 1347-9142A2, 1347-8460A3
(Remanufacturado)
 Use kit carb 18-7095 & junta 18-0462



18-79994N
CARBURADOR
 Reemplaza: 3310-866142A04,
 3310-866142A03
 Para: TKS-5.0L



18-79995N
CARBURADOR
 Reemplaza: 3310-866143A03
 Para: TKS-5.7L



18-79996
CARBURADOR
(Remanufacturado)
 Reemplaza: 3310-818660A1
 Para: Weber 4.3L (1992-96)



18-79997
CARBURADOR
(Remanufacturado)
 Reemplaza: 3310-807826A1
 Para: Weber 4.3L (1996 & sup)



APLICACIÓN CARBURADOR

Modelo	CID / # Cil	Intervalo de años	Desde N° serie #	Hasta N° Serie #	Original Carb Num. referencia	Código carb	Modelo rep. Carburador	Repuesto carb	Flotador Number	carburador Sierra Carb #
90	96/L4	1970-1971	2851424	3225967	1351- 4263A 1	7040082 R2/2GC	18-7746	1347-818619R02	18-7200	18-7609-1
90	96/L4	1972	3225868	3226957	1351- 4263A 1	7036543 R2/2GC	18-7746	1347-818619R02	18-7200	18-7609-1
110	153/L4	1963-1966	1357370	2044033	1336-2076	R2/2GC	—	—	—	18-7609-1
120	153/L4	1972-1973	3377341	3770649	1351-4263A3	7043182 R2/2GC	18-7746	1347-818619R02	18-7200	18-7609-1
120	153/L4	1974-1975	3770650	4469865	1351-5202A1	7044182 R2/2GC	18-7746	1347-818619R02	18-7200	18-7609-1
120	153/L4	1976-1978	4469866	5192048	1351-6065A2	7044182 R2/2GC	18-7746	1347-818619R02	18-7200	18-7609-1
120	153/L4	1979-1982	5192049	6229717	1351-7354A1	17059054 R2/2GC	18-7746	1347-818619R02	18-7200	18-7609-1
120	153/L4	1983	6229718	6663797	1351- 8480A 2	17081060 R2/2GC	18-7746	1347-818621R02	18-7200	18-7610-1
120	153/L4	1984	6663798	6853913	1389- 8490A 2	M2/MERCARB	18-7097	3310-860070A 2	18-7202	—
120	153/L4	1985	6853914	A492055	1389- 9350A 2	M2/MERCARB	18-7097	3310-860070A 2	18-7202	—
120	153/L4	1986	A492056	B531853	1389- 9562A 1	M2/MERCARB	18-7098-1	3310-860070A 2	18-7202	—
2.5L	153/L4	1983-1989	B531854	C853255	3310-806077A 2	M2/MERCARB	18-7098-1	3310-860070A 2	18-7202	—
140	181/L4	1968-1969	2508261	2816416	1351- 3635A 1	7036646 R/2GC	18-7746	—	18-7200	—
140	181/L4	1970	2816417	2911439	1351- 4032A 1	7040080 R/2GC	18-7746	1347-818620R02	18-7200	18-7608-1
140	181/L4	1970-1973	2911440	3771644	1351-4293A1	7040084 R/2GC	18-7746	1347-818620R02	18-7200	18-7608-1
140	181/L4	1974-1978	3771645	5157668	1351-5203A1	7043184 R/2GC	18-7746	1347-818620R02	18-7200	18-7608-1
140	181/L4	1979-1982	5157669	6229717	1351-7355A1	17059052 R/2GC	18-7746	1347-818620R02	18-7200	18-7608-1
140	181/L4	1983	6229718	6671328	1351- 8480A 2	17081060 R/2GC	18-7746	1347-818521R02	18-7200	—
140	181/L4	1984	6671329	6852269	1389- 8490A 2	M2/MERCARB	18-7097	3310-860070A 2	18-7202	—
140	181/L4	1985	6852270	A484072	1389- 9350A 2	M2/MERCARB	18-7097	3310-860070A 2	18-7202	—
140	181/L4	1986	A484073	B450800	1389- 9562A 1	M2/MERCARB	18-7098-1	3310-860070A 2	18-7202	—
140/3.0L	181/L4	1983-1989	6229718	C856556	1351-8480A2	R2/2GC	—	1348-818621 1	—	18-7610-1
3.0L	181/L4	1987-1989	B450801	C856556	3310-806077A 2	M2/MERCARB	18-7098-1	3310-860070A 2	18-7202	—
3.0L	181/L4	1990	C856559	D447414	1389-815396A 2	M2/MERCARB	18-7098-1	3310-860070A 2	18-7202	—
3.0L	181/L4	1991-1993	D447415	D836075	1389-806077A 2	M2/MERCARB	18-7098-1	3310-860070A 2	18-7202	—
3.0L	181/L4	1993-1994	D836076	F603999	1389-806078A 1	M2/MERCARB	18-7098-1	3310-860070A 2	18-7202	—
3.0L	181/L4	1998-2002	L010042	M385672	3310-807504A 1	M2/MERCARB	18-7098-1	3310-8M0045397	18-7202	—
3.0L	181/L4	2003-2004	M385673	W301999	3310-864940A01	M2/MERCARB	18-7098-1	3310-8M0045397	18-7202	—
3.0L	181/L4	1999-2004	L382122	W301999	3310-864940A01	M2/MERCARB	18-7098-1	865959A01	18-7202	⑤
3.0L	181/L4	2004-2010	W302000	& SUP	3310-866140A02	M2/MERCARB	18-7098-1	3310-866140A02	18-7202	—
3.0LX	181/L4	1990-1997	C856559	K999999	1389-815397A 2	M2/MERCARB	18-7098-1	3310-8M0045397	18-7202	—
3.0LX	181/L4	1990-1997	C856559	K999999	3310-805924A 2	M2/MERCARB	18-7098-1	3310-8M0045397	18-7202	—
165 (4 CIL)	224/L4	1987	B434941	B774251	1389- 9564A 1	M2/MERCARB	18-7098-1	3310-860071A 2	18-7202	—
170	224/L4	1985-1989	6916779	B434940	1389- 9564A 1	M2/MERCARB	18-7098-1	3310-860071A 2	18-7202	—
180	224/L4	1987	B436391	B775248	1347- 9142A 2	17083522 R4/4ME	18-7077	—	18-7201	—
190 (4 CIL)	224/L4	1985-1986	6916779	B436390	1347- 9142A 2	17083522 R4/4ME	18-7077	—	18-7201	—
3.7L	224/L4	1988-1989	B774252	& SUP	1389- 9564A 1	M2/MERCARB	18-7098-1	3310-860071A 2	18-7202	—

- ① Starter automático
- ② Negro
- ③ Azul
- ④ Starter eléctrico frontal (azul)

- ⑤ En línea
- ⑥ Parte trasera (azul)
- ⑦ Separador montado
- ⑧ Utilizar si es MERCARB carb. original
- ⑨ Utilizar si es carb. original Rochester

- ⑩ Use con transmisión en línea
- ⑪ Use con transmisión V-drive
- ⑫ V-drive
- ⑬ Cufia montada
- ⑭ TKS kit actualización

APLICACIÓN CARBURADOR

Modelo	CID / # Cil	Intervalo de años	Desde Nº serie #	Hasta Nº Serie #	Original Carb Num. referencia	Código carb	Modelo rep. Carburador	Repuesto carb	Flotador Número	Carburador Sierra Carb #
3.7LX	224/L4	1988-1989	B775249	& SUP	1347-9142A 2	17083522 R4/4ME	18-7077	—	18-7201	—
470	224/L4	1976-1984	4208730	6916778	1376-5990A 1	17057132 R2/2GC	18-7076	3310-860071A 4	18-7202 ⑩	—
470	224/L4	1983-1984	6218037	6916778	1389-8489A 5	M2/MERCARB	18-7097	3310-860071A 2	18-7202 ④	—
485	224/L4	1980-1982	5685394	6218036	1376-5990A 1	17057132 R2/2GC	18-7076	3310-860071A 4	18-7202	—
488	224/L4	1983-1984	6170297	6916778	1347-8460A 3	17081299 R4/4ME	18-7077	—	18-7201	18-7619-1
150	230/L6	1964-1966	1830152	2048046	1338-2633	8025188 R2/2GC	18-7746	—	18-7200	—
160	250/L6	1967-1968	2048022	2492038	1338-2991	7026088 R2/2GC	18-7746	—	18-7200	—
160	250/L6	1969	2492036	277031	1351-3635A 1	7036646 R/2GC	18-7746	—	18-7200	—
165 (6 Cil)	250/L6	1970-1972	3774865	3354791	1351-4282A1	7043183 R2/2GC	18-7746	1347-818620R02	18-7200	18-7608-1
165 (6 Cil)	250/L6	1979-1981	5178959	5813433	1351-7356A1	17059050 R2/2GC	18-7746	1347-818620R02	18-7200	18-7608-1
165 (6 Cil)	L6	1972-1973	3354702	3774864	1351-4871A1	R2/2GC	—	1347-818620 1	—	18-7608-1
180/190 3.7L					—	R4/4ME	—	1347-8460	—	18-7619-1
L4 Engine	—	1985-1989	6916779	último	1347-9142A2	R4/4ME	—	—	—	18-7619-1
200 (6 Cil)	292/L6	1969	2453769	2494935	1347-3237A 4	7037082 R4/4MV	18-7077	—	18-7201	—
185 (4bb)	229/V-6	1993-1994	6330183	6919655	3300-8886A 2	17083515 R4/4ME	18-7077	—	18-7201	—
175	262/V-6	1987	B527955	B773242	3304-9565A 1	M2/MERCARB	18-7098-1	3310-807764A 1	18-7202	—
185	262/V-6	1985-1986	A331455	B527954	3304-9353A 2	M2/MERCARB	18-7097	3310-807764A 1	18-7202	—
205	262/V-6	1985-1987	A331455	B775129	3304-9354A2	17084516 R4/4MV	18-7077	—	18-7201	18-7605-1
4.3L	262/V-6	1988-1992	B773243	D714106	3304-9565A 1	M2/MERCARB	18-7098-1	3310-807764A 1	18-7202	—
4.3L	262/V-6	1992-1993	D714107	F000877	3304-9565A 1	M2/MERCARB	18-7098-1	3310-807764A 1	18-7202	—
4.3L	262/V-6	1993-1995	F000878	F601126	3310-806972A 1	M2/MERCARB	18-7098-1	3310-807764A 1	18-7202	—
4.3L	262/V-6	1996-2002	F601127	M614999	3310-807764A 1	M2/MERCARB	18-7098-1	3310-807764A 1	18-7202	—
4.3L	262/V-6	2002-2004	M615000	W300012	3310-864941A01	M2/MERCARB	18-7098-1	3310-864941A01	18-7202	—
4.3L	262/V-6	2000-2004	L619000	W300012	3310-864941A01	M2/MERCARB	18-7098-1	865960A02	18-7202 ⑤	—
4.3L	262/V-6	2004-2010	W300013	& SUP	3310-866141A02	M2/MERCARB	18-7098-1	3310-866141A02	18-7202	—
4.3LH	262/V-6	1998-2002	L010044	M614999	3310-807826A 1	9666 WEBER	18-7749	—	—	—
4.3LX	262/V-6	1988-1991	B775130	D714369	3304-9354A 2	17084516 R4/4MV	18-7077	1347-804623R02	18-7201	18-7605-1
4.3LX	262/V-6	1992-1996	D714370	F802999	3310-818660A 1	9600 WEBER	18-7749	—	—	—
4.3XH	262/V-6	1996-1997	F803114	K999999	3310-807826A 1	9666 WEBER	18-7749	—	—	—
215 MCM/MIE (FORD)	302/V-8	1970-1972	2781153	3385720	1356-4066	C9FF9510E H4/4160	18-7096	1356-804628R02	18-7206	—
225 MCM/MIE (FORD)	302/V-8	1973-1974	3385721	4166999	1356-5155	D2JL9510C H4/4160	18-7096	1356-804628R02	18-7206	—
888	302/V-8	1971-1977	3108723	4887829	1376-5659A1	7044185 R2/2GC	18-7075	1376-818622R02	18-7202 ⑩	18-7603-1
888	302/V-8	1971-1977	3108723	4887829	1356-4642	D1JJ95108 H2/2300	18-7081	—	—	—
198 MIE	305/V-8	1977	4776402	4931099	1376-6491A 1	17057139 R2/2GC	18-7075	3310-861080A 1	18-7202	—
200	305/V-8	1985-1986	6899058	A482026	1389-8488A 2	M2/MERCARB	18-7097	3310-861080A 1	18-7202	—
200	305/V-8	1985-1987	A482027	B525981	1389-9563A 1	M2/MERCARB	18-7098-1	3310-861080A 1	18-7202	—
200	305/V-8	1987	B525982	B774444	1389-9670A 2	M2/MERCARB	18-7098-1	3310-807312A1	18-7202	—
228	305/V-8	1977-1978	4765100	5069430	1347-6427A1	17057282 R4/4MV	18-7077	9661A 3	18-7201	18-7605-1
228	305/V-8	1978-1981	5069431	6021783	1347-7361A1	17059292 R4/4MV	18-7077	9661A 3	18-7201	18-7605-1
228	305/V-8	1982	6021784	6218461	1347-8296A4	17080565 R4/4MV	18-7077	9661A 3	18-7201	18-7605-1
228	305/V-8	1982-1984	6218462	6899268	1347-9661A 3	17080565 R4/4MV	18-7077	9661A 3	18-7201	18-7605-1
228 MIE	305/V-8	1977-1978	4765100	5069430	1347-6438A1	17057283 R4/4MV	18-7077	9661A 3	18-7201	18-7605-1
228 MIE	305/V-8	1978-1982	5069431	6040745	1347-7364A1	17059291 R4/4MV	18-7077	9661A 3	18-7201	18-7605-1
228 TR	305/V-8	1977-1978	4765100	5069430	1347-6438A 1	17057283 R4/4MV	18-7077	9661A 3	18-7201	18-7605-1
230	305/V-8	1985-1987	6899269	B773739	1347-9661A 3	17080565 R4/4MV	18-7077	9661A 3	18-7201	18-7605-1
230 MIE	305/V-8	1982-1987	6040746	B788151	1347-8290A1	17080564 R4/4MV	18-7077	9661A 3	18-7201	18-7605-1
223/230/5.0LX	V-8	1983-1995	6218462	F600999	1347-9661A3	R4/4MV	—	1347-9661A3	—	18-7605-1
5.0L	305/V-8	1988-1995	B774445	F600999	1389-9670A 2	M2/MERCARB	18-7098-1	3310-807312A1	18-7202	—
5.0L (GEN +)	305/V-8	1998-2002	L015751	M599999	3310-861448A 1	M2/MERCARB	18-7098-1	3310-864942A01	18-7202	—
5.0L (GEN +)	305/V-8	2002-2004	M600000	W300009	3310-864942A01	M2/MERCARB	18-7098-1	3310-864942A01	18-7202	—
5.0L (GEN +)	305/V-8	2000-2004	L619000	W300009	3310-864942A01	M2/MERCARB	18-7098-1	865961A02	18-7202 ⑤	—
5.0L (GEN +)	305/V-8	2004-2010	W300010	& SUP	3310-866142A03	M2/MERCARB	18-7098-1	3310-866142A04	18-7202	—
5.0LX	305/V-8	1988-1995	B773740	F600999	1347-9661A 3	17080565 R4/4MV	18-7077	9661A 3	18-7201	18-7605-1
898/200/5.0L	V-8	1987-95	B525982	F600999	1389-9670A2	M2/MERCARB	—	3310-807312A1	—	18-7611-1
898	305/V-8	1977	4762210	6021383	1376-6491A 1	17057139 R2/2GC	18-7075	3310-861080A 1	18-7202	—
898	305/V-8	1982	6021384	6218461	1376-8295A 3	17080350 R2/2GC	18-7075	3310-861080A 1	18-7202	—
898	305/V-8	1983-1984	6218462	6899057	1389-8488A 2	M2/MERCARB	18-7097	3310-861080A 1	18-7202	—
225 MCM/MIE (GM)	327/V-8	1963-1969	1539620	2694014	1347-3237A 3	④ 7037082 R4/4MV	—	1347-804624R02	—	18-7615N
250	350/V-8	1977	4768000	4908849	1347-3353	① 7037082 R4/4MV	—	1347-804624R02	—	18-7615N
250	350/V-8	1977	4768000	4908849	1347-3237A 3	② 7037082 R4/4MV	—	1347-804624R02	—	18-7615N
255	350/V-8	1975-1976	4175550	4767999	1347-5732A 1	7044291 R4/4MV	18-7077	1347-804624R02	18-7201	18-7615N
255 MIE (GM)	350/V-8	1975-1978	4175550	4924564	1347-5732A 1	7044291 R4/4MV	18-7077	1347-804624R02	18-7201	18-7615N
255 MIE (GM)	350/V-8	1978	4924565	5195908	1347-7062A1	17057292 R4/4MV	18-7077	1347-804624R02	18-7201	18-7615N
255 MIE (GM)	350/V-8	1979-1980	5195909	5907057	1347-7365A1	17059299 R4/4MV	18-7077	1347-804624R02	18-7201	18-7615N
260 MIE	V-8	1980-1986	5907058	B522505	1347-8289A1	R4/4MV	—	1347-8289A1	—	18-7618-1
260	350/V-8	1978	4908850	5068085	1347-6492A 1	17057298 R4/4MV	18-7077	1347-804624R02	18-7201	18-7615N
260	350/V-8	1976-1982	5068086	6024393	1347-7362A 1	17059288 R4/4MV	18-7077	1347-804624R02	18-7201	18-7615N
260	350/V-8	1982-1987	6024393	B525981	1347-8292A 4	17080561 R4/4MV	18-7077	1347-804624R02	18-7201	18-7615N
260	350/V-8	1987	B525982	B773304	1347-9662A 1	17080561 R4/4MV	18-7077	1347-804624R02	18-7201	18-7615N
260 MIE	350/V-8	1981-1987	5907058	B522505	1347-8289A 1	17080562 R4/4MV	18-7077	1347-804624R02	18-7201	18-7615N
260 MIE	350/V-8	1987	B522506	B788151	1347-9662A 1	17080561 R4/4MV	18-7077	1347-804624R02	18-7201	18-7615N

- ① Starter automático
- ② negro
- ③ Azul
- ④ Starter eléctrico
- ⑤ Frontal (Azul)

- ⑥ En línea
- ⑦ Parte trasera (azul)
- ⑧ Separador montado
- ⑨ Utilizar si es MERCARB carb. original
- ⑩ Utilizar si es carb. original Rochester

- ⑪ Use con transmisión en línea
- ⑫ Use con transmisión V-drive
- ⑬ V-drive
- ⑭ Cufia montada
- ⑮ TKS kit actualización

APLICACIÓN CARBURADOR

Modelo	CID / # Cil.	Intervalo año	Desde Nº serie #	Hasta Nº serie #	Original Carb Núm. ref	Código carb	Modelo rep. carb	Repuesto carb	Flotador	Carburador Sierra
260/5.7MIE	V-8	1987-1993	B522506	F024999	1347-966A4	R4/4MV	—	1347-816373A4	—	18-7615N
260/5.7L ALPHA	V-8	1987-1993	B525982	F000454	1347-9662A4	R4/4MV	—	1347-816373A4	—	18-7615N
270 MCM/MIE	350V-8	1969-1972	2851074	3385720	1347- 4180A 1	7029285 R4/4MV	18-7077	—	18-7201	—
280 TRS	350V-8	1975	4176250	4176468	1347- 4179A 2	7040283 R4/4MV	18-7077	—	18-7201	—
280 TRS	350V-8	1975-1976	4176469	4770199	1347- 5981A 1	7044290 R4/4MV	18-7077	—	18-7201	—
300 MR/TRS	350V-8	1985-1986	6668677	B430367	1347- 7498A 7	17059280 R4/4MV	18-7077	—	18-7201	18-7615N
350 MAG ALPHA	350V-8	1986-1991	A635178	D617327	1347- 8289A 1	17080562 R4/4MV	18-7077	1347-804624R02	18-7201	18-7615N
350 MAG ALPHA	350V-8	1992-1995	D617328	F600999	3310-806970A 1	9770SA WEBER	18-7749	3310-807262A 1	—	—
350 MAG ALPHA	350V-8	1996-1997	F601000	K999999	3310-807262A 2	9781 WEBER	18-7748	—	—	—
350 MAG SKI	350V-8	1991-1996	D505450	K040399	3310-806970A 1	9770SA WEBER	18-7749	—	—	①
350 MAG SKI	350V-8	1991-1997	D505450	K999999	3310-807262A 2	9781 WEBER	18-7748	—	—	①
350 MAG SKI	350V-8	1997	K040400	K999999	3310-860371A 1	9781SB WEBER	18-7748	—	—	②
5.7L (2BBL)	350V-8	1996-1997	F601000	K999999	3310-807312A1	M2/MERCARB	18-7098-1	3310-807312A1	18-7202	18-7611-2
5.7L (GEN +) (2bbl)	350V-8	1998-2002	L010037	M599999	3310-861245A 1	M2/MERCARB	18-7098-1	3310-864943A01	18-7202	18-7639
5.7L (GEN +) (2bbl)	350V-8	2002-2004	M600000	W300754	3310-864943A01	M2/MERCARB	18-7098-1	3310-864943A01	18-7202	18-7639
5.7L (GEN +) (2bbl)	350V-8	2000-2004	L015751	W300754	3310-864943A01	M2/MERCARB	18-7098-1	865962A02	18-7202	⑤
5.7L (Gen II)	V-8	1998-2004	L010037	W300754	3310-864943101	M2/MERCARB	—	3310-864943101	—	18-7639
5.7L (GEN +) (2bbl)	350V-8	2004-2010	W300755	& SUP	3310-866143A03	M2/MERCARB	18-7098-1	3310-866143A03	18-7202	—
5.7L ALPHA	350V-8	1988-1993	B773305	F000454	1347- 9662A 4	17080561 R4/4MV	18-7077	1347-804624R02	18-7201	18-7615N
5.7L ALPHA	350V-8	1993-1994	F000455	F273497	3310-805484A 1	9661 WEBER	18-7749	—	—	—
5.7L ALPHA	350V-8	1993-1994	F000455	F273497	3310-806761A 1	9665S WEBER	18-7748	—	—	—
5.7L ALPHA	350V-8	1994-1995	F273498	F600999	3310-806761A 3	9665S WEBER	18-7748	3310-806761A 3	—	—
5.7L BRAVO (W/O HIGH RISE INTAKE)	350V-8	1988-1991	B773305	D617327	1347- 9662A 4	17080561 R4/4MV	18-7077	1347-804624R02	18-7201	18-7615N
5.7L BRAVO (W/HIGH RISE INTAKE)	350V-8	1988-1991	B773305	D617327	1347- 8289A 1	17080562 R4/4MV	18-7077	1347-804624R02	18-7201	18-7615N
5.7L BRAVO W/O HIGH RISE INTAKE	V-8	1987-1991	OB525982	OD617327	1347-9662A4	R4/4MV	—	1347-816373A4	—	18-7615N
5.7L BRAVO W/HIGH RISE INTAKE	V-8	1987-1991	OB525982	OD617327	1347-8289A1	R4/4MV	—	1347-8289A1	—	18-7618-1
5.7L BRAVO	350V-8	1992-1995	D617328	F600999	3310-806970A 1	9770SA WEBER	18-7749	3310-807262A 1	—	—
5.7L MIE	350V-8	1988-1992	B768152	D715493	1347- 9662A 4	17080561 R4/4MV	18-7077	1347-804624R02	18-7201	18-7615N
5.7L MIE	350V-8	1992-1994	D715494	F349999	3310-806761A 2	9665S WEBER	18-7748	3310-806761A 2	—	—
5.7L MIE	350V-8	1995	F349300	F622099	3310-806761A 3	9665S WEBER	18-7748	3310-806761A 3	—	—
5.7L MIE (2bbl)	350V-8	1998-2002	L002003	M316999	3310-861245A 1	M2/MERCARB	18-7098-1	3310-864943A01	18-7202	18-7639
5.7L MIE (2bbl)	350V-8	2002-2004	M317000	W090899	3310-864943A01	M2/MERCARB	18-7098-1	3310-864943A01	18-7202	18-7639
5.7L MIE (2bbl)	350V-8	2000-2004	L390600	W090899	3310-864943A01	M2/MERCARB	18-7098-1	865962A02	18-7202	⑤
5.7L MIE (2bbl)	350V-8	2004-2010	W090900	& SUP	3310-866143A03	M2/MERCARB	18-7098-1	3310-866143A03	18-7202	—
5.7L SKI	350V-8	1985-1987	A338553	B514626	1347- 9415T	17085013 R4/4MV	18-7077	9415T	18-7201	—
5.7L SKI	V-8	1985-1993	A338533	F025099	1347-9415T	R4/4MV	—	1347-9415T	—	18-7615N
5.7L SKI	350V-8	1987-1995	F450000	F775199	3310-805484A 1	9661 WEBER	18-7749	3310-806761A 3	—	—
5.7L SKI (2bbl)	350V-8	1996-1997	F775200	K999999	3310-807312A1	M2/MERCARB	18-7098-1	3310-807312A1	18-7202	18-7611-2
5.7L SKI (GEN +) (2bbl)	350V-8	1998-2002	L002005	M316999	3310-861245A 1	M2/MERCARB	18-7098-1	3310-864943A01	—	18-7639
5.7L SKI (GEN +) (2bbl)	350V-8	2002-2004	M317000	W090899	3310-864943A01	M2/MERCARB	18-7098-1	3310-864943A01	—	18-7639
5.7L SKI (GEN +) (2bbl)	350V-8	2000-2004	L390600	W090899	3310-864943A01	M2/MERCARB	18-7098-1	865962A02	18-7202	⑤
5.7L SKI (GEN +) (2bbl)	350V-8	2004-2010	W090900	& SUP	3310-866143A03	M2/MERCARB	18-7098-1	3310-866143A03	18-7202	—
5.7LX (4bbl)	350V-8	1996-1997	F601000	K999999	3310-807262A 2	9761 WEBER	18-7748	—	—	—
233 MCM & MCI (FORD)	351V-8	1975-1977	4173000	4465029	1376- 5744 1	7044187 R2/2GC	18-7075	1347-818622R02	—	18-7603-1
233 MCM & MCI (FORD)	351V-8	1975-1977	4465030	4902304	1376- 6152A 1	17056197 R2/2GC	18-7075	1347-818622R02	—	18-7603-1
325 MCM/MIE	427V-8	1969-1970	2278747	3042730	1347- 3342	7027080 R4/4MV	18-7077	—	18-7201	—
325 MCM/MIE	427V-8	1971-1972	3042731	3780449	1347- 4533A 1	7041831 R4/4MV	18-7077	—	18-7201	—
325 MCM/MIE	427V-8	1969-1972	2278747	3780449	1347- 3689A 1	7029280 R4/4MV	18-7077	—	18-7201	—
330 MCM	427V-8	1977-1978	4623115	5027230	1347-6493A1	17057287 R4/4MV	18-7077	1347-804626R02	18-7201	18-7616-1
330 MCM	427V-8	1977-1981	5027231	6083144	1347-7363A1	17059290 R4/4MV	18-7077	1347-804626R02	18-7201	18-7616-1
330 MCM	427V-8	1982-1987	6083145	B816540	1347-8291A3	17080563 R4/4MV	18-7077	1347-804626R02	18-7201	18-7616-1
330 MIE	427V-8	1977-1978	4623115	5226384	1347-6493A1	17057287 R4/4MV	18-7077	1347-804626R02	18-7201	18-7616-1
330 MIE	427V-8	1979-1980	5226385	5889913	1347-7366A1	17059287 R4/4MV	18-7077	1347-804626R02	18-7201	18-7616-1
340 MIE	454V-8	1981-1987	5889914	D788365	1347-8288A1	17080560 R4/4MV	18-7077	1347-804626R02	18-7201	18-7616-1
370	454V-8	1978-1987	4179554	B714586	1347- 7498A 2	17059280 R4/4MV	18-7077	1347-804625R02	18-7201	—
400	454V-8	1980-1986	4179554	B457644	1347- 7498A 2	17059280 R4/4MV	18-7077	1347-804625R02	18-7201	—
420	454V-8	1987-1989	A398941	B622418	13549A 4	H4	18-7751	—	—	—
425	454V-8	1990-1993	B622419	D937011	13549A 4	H4	18-7751	—	—	—
440	454V-8	1983-1986	4179554	B485220	1393- 8862A 1	H4	18-7751	—	—	—
450	454V-8	1995-1996	F347100	F347277	13549A14	H4	18-7751	—	—	—
454 MAG ALPHA	454V-8	1986-1988	A631894	B785148	1347-8291A3	17080563 R4/4MV	18-7077	1347-804626R02	18-7201	18-7616-1
454 MAG BRAVO	454V-8	1988-1992	B721206	D808068	1347-7498A2	17059280 R4/4MV	18-7077	1347-804625R02	18-7201	18-7617-1
454 MAG BRAVO	454V-8	1992-1994	D805069	F304999	3310-806755A 1	9779 WEBER	18-7748	—	—	—
454 MAG BRAVO	454V-8	1995-1997	F305000	K999999	3310-806755A 2	9779 WEBER	18-7748	—	—	—
7.4L BRAVO I/II	454V-8	1988-1991	B771113	D603117	1347-8291A3	17080563 R4/4MV	18-7077	1347-804626R02	18-7201	18-7616-1
7.4L BRAVO I/II	454V-8	1992-1994	D603118	F351999	3310-806969A 2	9780 WEBER	18-7748	—	—	—
7.4L BRAVO I/II	454V-8	1995-1997	F352000	K999999	3310-806969A1	9780 WEBER	18-7748	3310-806969A 1	—	18-7613-1
7.4L BRAVO III	454V-8	1993-1996	D838819	F800699	3310-806755A 2	9779 WEBER	18-7748	—	—	—

- ① Starter automático
- ② Negro
- ③ Azul
- ④ Starter automático
- ⑤ Frontal (Azul)

- ⑥ En línea
- ⑦ Parte trasera (azul)
- ⑧ Separador montado
- ⑨ Utilizar si es MERCARB carb.original
- ⑩ Utilizar si es carb. original Rochester

- ① Use con transmisión en línea
- ② Use con transmisión V-drive
- ③ V-drive
- ④ Cufia montada
- ⑤ TKS Kit actualización

APLICACIÓN CARBURADOR

Modelo	CID / # Cil	Intervalo Años	Desde N° serie #	Hasta N° serie #	Original Carb Núm. ref	Modelo Código carb	Modelo rep. carb	Repuesto carb.	Flotador	carburador Sierra
7.4L BRAVO III	454/V-8	1996-1997	F800700	K999999	3310-806969A1	9780 WEBER	18-7748	3310-806969A 1	—	18-7613-1
7.4L MIE	454/V-8	1988-1992	5889914	D715493	1347- 8268A 1	17080560 R4/4MV	18-7077	1347-804626R02	18-7201	18-7616-1
460	482/V-8	1983-1986	4179554	B485220	1393- 8862A 1	H4	18-7751	—	—	—
465	502/V-8	1990-1992	C849992	F213244	—	H4	18-7751	—	②	—
465	502/V-8	1990-1992	C849992	F213244	—	H4	18-7751	—	③	—
500	502/V-8	1994-1995	F213293	F615766	13549A12	H4	18-7751	—	③	—
500	502/V-8	1996-1998	F615767	L001772	13549A 15	H4	18-7751	—	③	—
500 (GEN +)	502/V-8	1999	L414639	L601036	13549T21	H4	18-7751	—	③	—
502 MAG	502/V-8	1990-1992	C878221	D824588	1347-814623A 2	17089112 R4/4MV	18-7077	—	18-7201	—
502 MAG	502/V-8	1992-1993	D824589	F114528	3310-806971A 1	9782 WEBER	18-7748	—	—	—
8.2L MIE	502/V-8	1990-1992	C878221	D857199	1347-814623A 2	17089113 R4/4MV	18-7077	—	—	—
8.2L MIE	502/V-8	1990-1992	C878221	D857199	3310-817693A 1	9774 WEBER	18-7748	—	—	—
8.2L MIE	502/V-8	1993-1996	D857200	F819619	3310-806971A 1	9782 WEBER	18-7748	—	—	—
500 BULLDOG	540/V-8	1990-1995	C577254	F348987	13549A10	H4	18-7751	—	③	—
500 BULLDOG	540/V-8	1995-2001	F615762	M050281	13549A23	H4	18-7751	—	③	—

- ① Starter automático
- ② negro
- ③ azul
- ④ Starter eléctrico
- ⑤ Frontal (Azul)

- ⑥ En línea
- ⑦ Parte trasera (azul)
- ⑧ Separador montado
- ⑨ Utilizar si es MERCarb carb.original
- ⑩ Utilizar si es carb. original Rochester

- ⑪ Use con transmisión en línea
- ⑫ Use con transmisión V-drive
- ⑬ V-drive
- ⑭ Cuña montada
- ⑮ TKS kit actualización

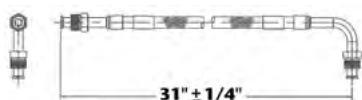

18-8114

LINEA DE COMBUSTIBLE

Conexión de la bomba de combustible. Reemplaza tubo de 3/8 X 31". PTFE con terminales macho de 5/8"-18 y 5/8"-18 90°. SAE J1527 tipo A1

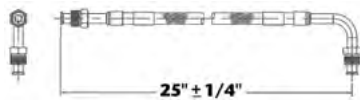

18-8115

LINEA DE COMBUSTIBLE

Conexión de la bomba combustible al carburador. Reemplaza tubo de 3/8" X 25" PTFE con terminales macho 5/8"-18 y 5/8"-18 90°. SAE J1527 tipo A1

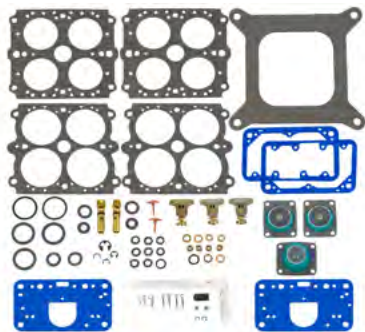

**18-7751
KIT CARB**

Reemplaza: 13220

Para: GM 420 V8 454 (1987-89), GM 425 V8 454 (1990-93), GM 425 (Gen V) V8 454 (1992-93), 440 TRS GM 454 (1983-86), GM 450 V8 454(1995-96), 460 TRS V8 482 (1983-86), GM 465 V8 502 (1990-92), GM 465 (Gen V) V8 502 (1992-94), 500 (Gen+) GM 502 V8 (1999), 500 (Gen V) 502 V8 (1994-98), 500 Bulldog 540 V8 (1990-01)



**18-7071
KIT CARB**

Reemplaza: 1397-3458



**18-7075
KIT CARB**

Reemplaza: 1397-5830, 1397-7099, 1397-8760, 1397-5831



**18-7070
KIT CARB**

Reemplaza: 1397-2072, 1397-7542, 1397-2637, 1397-7543, 1397-8872, 1397-3464,



**18-7072
KIT CARB**
Reemplaza: 1397-3306, 1397-4329,
1397-5635, 1397-6638, 823426A1



**18-7076
KIT CARB**
Reemplaza: 1397-6367, A1



**18-7077
KIT CARB**
Reemplaza: 1397-8952, 823426A1

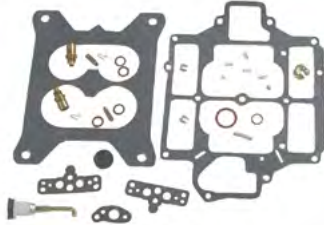

**18-7078
KIT CARB**
Reemplaza: 1397-2605, 1397-3462,
1397-2133, 1337-2604, 1337-2103



**18-7080
KIT CARB**
Reemplaza: 1398-3089, 1346-2770



**18-7081
KIT CARB**
Reemplaza: 1396-4656
Contiene agujas y asientos ajustables

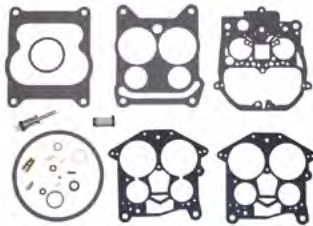

**18-7095
KIT CARB**
Reemplaza: 1397-7539, 1397-7540,
1397-7544, 1397-8535, 1397-9723



**18-7096
KIT CARB**
Reemplaza: 1396-5238, 1396-5222,
1356-5169, 1356-5155, 1356-4092,
1356-4066
Contiene agujas y asientos ajustables



**18-7097
KIT CARB**
Reemplaza: 3302-9437, 3302-804845
MerCarb 2 bbl. bottom fondo llenado bomba acelerador
1983-1986 MCM 120, 140, 470, 185, 200, 898.



**18-7098-1
KIT CARB**
Reemplaza 3302-804844002,
3302-804844001, 3302-804844
MerCarb 2 bbl. llenado lateral bomba acelerador
1986 y sup. MCM 4-cil., V6 & V8



**18-7728
KIT CARB**

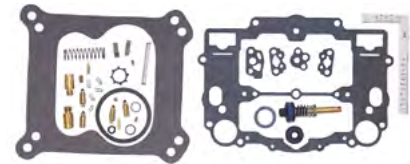

**18-7749
KIT CARB**
Reemplaza: 809065, 835076, 823728





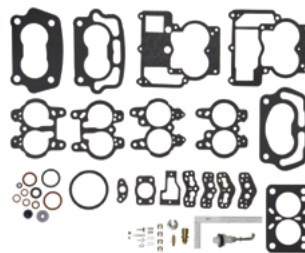





**18-7748
KIT CARB**
Reemplaza: 809064



**18-7746
KIT CARB**
Reemplaza: 823427A1, 1397-8873, 1397-
8872, 1397-7547, 1397-7543, 1397-7542,
1397-3464, 1397-3459, 1397-2637, 1397-
2634, 1397-2631, 1397-2067
Kit reparación para 2 BBL Rochester



**18-34075
KIT ESPACIADOR CARB**
Se adapta a Holley, Edelbrock, Carter AFB
cuadrado a colector Rochester

 <p>18-7200 FLOTADOR REEMPLAZA: 1397-2060 (Resistente al alcohol) Plástico</p>	 <p>18-7201 FLOTADOR Reemplaza: 1397-3327, 1397-8546, 1397-8959 (Resistente al alcohol) Brass</p>	 <p>18-7202 FLOTADOR Reemplaza: 1397-5837, 3302-9031 (Resistente al alcohol) Brass</p>
 <p>18-36906 FLOTADOR CARB Reemplaza: 811536, 811536T Para: Mercruiser con 4 bbl Weber Carb</p>	 <p>18-7666 INTERRUPTOR PRESIÓN Reemplaza: 1397-8582 carburadores Rochester 4V</p>	 <p>18-7664 TERMOSTATO STARTER Reemplaza: 809066 Carburadores Weber 4V con starter eléctrico</p>
 <p>18-7665 TERMOSTATO STARTER Reemplaza: 70125A1, 70125A02, 70125 Rochester & Mercarb 2V con starter eléctrico</p>	 <p>18-7667 TERMOSTATO STARTER Reemplaza: 71464A01, 71464, 72625 Carburador Rochester con estrangulador separado</p>	 <p>18-7227 TERMOSTATO STARTER Reemplaza: 1396-4148 Para carburador Holley</p>

APLICACIÓN KIT CARBURADOR/FLOTADOR

Modelo & serie #	Mercruiser Carb. #	Mfg. Carb. #	código carb & Modelo	Kit carb. ①	Flotador
TODOS MCM 80	1346-2770	RBS-4394S	C1/RBS	18-7080	—
MCM 90					
3225967 & Inf.	1351-4263A1	7040082	R2/2GC	18-7746	18-7200
3225968 & encima	1351-4263A2	7041369	R2/2GC	18-7746	18-7200
TODOS MCM110	1336-2076	7036543	R2/2GC	18-7070	18-7200
MCM 120/2.5L					
2520424 & inf.	1336-2076	7036543	R2/2GC	18-7746	18-7200
2520425-3377340	1336-3594A1	7036543	R2/2GC	18-7746	18-7200
3377341-3770649	1351-4263A3	7041369	R2/2GC	18-7746	18-7200
3770650-4469865	1351-5202A1	7043182	R2/2GC	18-7746	18-7200
4469866-5192047	1351-6065A2	7044182	R2/2GC	18-7746	18-7200
5192048-6229717	1351-7354A1	17059054	R2/2GC	18-7746	18-7200
6229718 & encima	1351-8480A2	17081060	R2/2GC	18-7746	18-7200
6229718 & encima	1389-8490A2	N/D	M2/Mercarb	18-7097	18-7202
6229718 & encima	1389-9350A2	N/D	M2/Mercarb	18-7097	18-7202
6229718 & encima	1389-9562A1	N/D	M2/Mercarb	18-7098-1	18-7202
MCM 140 /3.0L/3.0LX(4 cil.)					
2816416 & inf.	1351-3635A1	7036646	R2/2GC	18-7746	18-7200
2816417-3332137	1351-4032A1	7040080	R2/2GC	18-7746	18-7200
3332138-3771644	1351-4293A1	7040084	R2/2GC	18-7746	18-7200
3771645-5157668	1351-5203A1	7043184	R2/2GC	18-7746	18-7200
5157669-6229717	1351-7355A1	17059052	R2/2GC	18-7746	18-7200
6229718-C856558	1351-8480A2	17081060	R2/2GC	18-7746	18-7200
6229718-C856558	1389-8490A2	N/D	M2/Mercarb	18-7097	18-7202
6229718-C856558	1389-9350A2	N/D	M2/Mercarb	18-7097	18-7202
6229718-C856558	1389-9562A1	N/D	M2/Mercarb	18-7098-1	18-7202
C856559 & encima	1389-815396A2	N/D	M2/Mercarb	18-7098-1	18-7202
C856559 & encima	1389-815397A2	N/D	M2/Mercarb	18-7098-1	18-7202
MCM 140 (6 cil)					
TODOS (BC)	1338-2161	7025638	R1/BC	18-7071	—

① NO INCLUYE BARRAS DE MEDICIÓN

APLICACIÓN CARBURADOR KIT/FLOTADOR (Cont.)

Modelo & Serie #	carburador Mercuriser #	Mfg. Carb. #	Código carb & Modelo	Kit carb ①	Flotador
TODOS (B)	1338-2166	7025662	R1/B	18-7071	—
MCM 150					
1823489 & post	1338-2428	7024180	R1/BC	18-7071	—
1823489 & post	1338-2431	7024181	R1/B	18-7071	—
1823490-1830151	1338-2608	7025183	R1/BC	18-7071	—
1823490-1830151	1338-2609	7025184	R1/B	18-7071	—
1830152 & ant	1338-2633	7025188	R2/2GC	18-7070	18-7200
MCM 160					
2492035 & post	1338-2991	7026088	R2/2GC	18-7746	18-7200
2492036 & ant	1351-3635A1	7036646	R2/2GC	18-7746	18-7200
MCM 165 (6 cil)					
3354701 & post	1351-4282A1	7040083	R2/2GC	18-7746	18-7200
3354702-3774864	1351-4871A1	7042183	R2/2GC	18-7746	18-7200
3774865-5178958	1351-5204A1	7043183	R2/2GC	18-7746	18-7200
5178959 & ant	1351-7356A1	17059050	R2/2GC	18-7746	18-7200
MCM 165/170/3.7L (4 cil)					
6218037-6916778	1389-8489A5	N/D	M2/Mercarb	18-7097	18-7202
6916779 & ant	1389-9564A1	N/D	M2/Mercarb	18-7098-1	18-7202
MCM 175/4.3L/185 (V-6)	3304-9565A1	N/D	M2/Mercarb	18-7098-1	18-7202
Todos (229 CID)					
A221455-D714106	3300-8886A2	17083515	R4/4MV	18-7095	18-7201
185 (262 CID)					
A221455-B527954	3304-9353A2	N/D	M2/Mercarb	18-7097	18-7202
MCM 205 (262 CID)	3304-9354A2	—	R4/4MV	18-7095	18-7201
A331455-D714369	3304-9565A1	N/D	M2/Mercarb	18-7098-1	18-7202
TODOS MCM/MIE 470	1376-5990A1	17057132	R2/2GC	18-7076	18-7202
TODOS MCM 485	1376-5990A1	17057132	R2/2GC	18-7076	18-7202
TODOS MCM 488	1347-8460A3	17081299	R4/4ME	18-7077	18-7201
MCM 888					
TODOS HOLLEY	1356-4642	D1JJ-9510-8	H2/2300	18-7081	18-7206
TODOS ROCHESTER	1376-5659A1	7044185	R2/2GC	18-7075	18-7202
MCM 180/190/3.7LX					
(4 cil)	1347-9142A2	17083522	R4/4MV	18-7095	18-7201
MIE 198/200/5.0L					
6021383 & post	1376-6491A1	17057139	R2/2GV	18-7075	18-7202
6021384 & ant	1376-8295A3	17080350	R2/2GV	18-7075	18-7202
MCM 200 (6 cil)					
2494935 & post	1347-3237A2	7037082	R4/4MV	18-7072	18-7201
2494936 & ant	1347-3237A4	7037082	R4/4MV	18-7072	18-7201
MCM 898/200/5.0L					
6218462 & ant	1389-8488A2	N/D	M2/Mercarb	18-7097	18-7202
6218462 & ant	1389-9563A1	N/D	M2/Mercarb	18-7098-1	18-7202
6218462 & ant	1389-9670A2	N/D	M2/Mercarb	18-7098-1	18-7202
MCM 205/4.3LX (V-6 262 CID)					
A331455-D714369	3304-9354A2	17084516	R4/4MV	18-7095	18-7201
TODOS MCM/MIE 215	1356-4066	C9FF-9510-E	H4/4160	18-7096	18-7206
MCM/MIE 225 (FORD)					
TODOS	1356-5155	D2JL-9510-C	H4/4160	18-7096	18-7206
MCM/MIE 225 (GM)	1337-2103	7025564	R4/4GC	18-7078	—
1536920-2694014	1337-2604	7025756	R4/4GC	18-7078	—
	1347-3353	7037082	R4/4MV	18-7072	18-7201
	1347-3237A3	7037082	R4/4MV	18-7072	18-7201
MCM 228					
5069430 & post	1347-6427A1	17057282	R4/4MV	18-7072	18-7201
MCM 228TR/ MIE 228					
5069430 & post	1347-6438A1	17057283	R4/4MV	18-7072	18-7201
MCM 228/230/5.0L					
5069431-6021783	1347-7361A1	17059292	R4/4MV	18-7095	—
6021784-6218461	1347-8296A4	17080565	R4/4MV	18-7095	18-7201
6218462 & post	1347-9661A3	—	R4/4MV	18-7095	18-7201
MIE 228					
5067431-6040745	1347-7364A1	17059291	R4/4MV	18-7095	18-7201

① NO INCLUYE BARRAS DE MEDICIÓN

APLICACIÓN CARBURADOR KIT/FLOTADOR (Cont.)

Modelo & Serie #	Carburador Mercruiser #	Mfg. Carb. #	Código carb & Modelo	Carb. Kit ①	Flotador
6040746 & ant	1347-8290A1	17080564	R4/4MV	18-7095	18-7201
TODOS MIE 230/5.0L	1347-8290A1	17080564	R4/4MV	18-7095	18-7201
230/5.0LX	1347-9661A3	—	R4/4MV	18-7095	18-7201
MCM/MIE 233					
4465029 & post	1376-5744A1	7044187	R2/2GC	18-7075	18-7202
4465030 & ant	1376-6152A1	17056197	R2/2GC	18-7075	18-7202
MCM/MIE 250 AUTO. CHOKE					
4767999 & post	1347-3353	7037082	R4/4MV	18-7072	18-7201
MCM/MIE 250 (EL. CHOKE)					
4767999 & post	1347-3237A3	7037082	R4/4MV	18-7072	18-7201
MCM 250					
4768000 & ant	1347-6492A1	17057298	R4/4MV	18-7072	18-7201
MCM/MIE 255 (GM)					
4924564 & post	1347-5732A1	7044291	R4/4MV	18-7072	18-7201
4924565-5195908	1347-7062A1	17057295	R4/4MV	18-7072	18-7201
5195909-5907067	1347-7365A1	17059289	R4/4MV	18-7095	18-7201
5907068 & ant	1347-8289A1	17080562	R4/4MV	18-7095	18-7201
MCM/MIE 255 (FORD)					
todos	1356-5169	D2JL-9510E	H4/4160	18-7096	18-7206
MCM 260/5.7L BRAVO					
5060805 & post	1347-6492A1	17057298	R4/4MV	18-7072	18-7201
5060806-6024393	1347-7362A1	17059288	R4/4MV	18-7095	18-7201
6024394-B525981	1347-8292A4	17080561	R4/4MV	18-7095	18-7201
B525982 & ant	1347-9662A4	—	R4/4MV	18-7095	18-7201
MIE 260/5.7L 350 MAG					
A635178-D617327	1347-8289A1	17080562	R4/4MV	18-7095	18-7201
MIE 5.7 SKI					
A339533-F205099	1347-9415T	17085013	R4/4MV	18-7095	18-7201
TODOS MCM/MIE 270	1347-4180A1	7029285	R4/4MV	18-7072	18-7201
MCM 280					
4176468 & post	1347-4179A2	7040283	R4/4MV	18-7072	18-7201
4176469 & ant	1347-5981A1	7044290	R4/4MV	18-7072	18-7201
MCM 300 MR/TRS (GM)					
6668677 & ant	1347-7498A7	—	R4/4MV	18-7095	18-7201
MCM/MIE 325 AUTO. CHOKE					
3042730 & post	1347-3342	7027080	R4/4MV	18-7072	18-7201
3042731 & ant	1347-4533A1	7041831	R4/4MV	18-7072	18-7201
MCM/MIE 325 EL. CHOKE					
2278747-378099	1347-3689A1	7029280	R4/4MV	18-7072	18-7201
MCM 330/454 MAGNUM (ALPHA ONE)					
5027230 & post	1347-6493A1	17057287	R4/4MV	18-7072	18-7201
5027231-6083144	1347-7363A1	17059290	R4/4MV	18-7095	18-7201
6083145 & ant	1347-8291A3	17080563	R4/4MV	18-7095	18-7201
MIE 330					
5226384 & post	1347-6493A1	17057287	R4/4MV	18-7072	18-7201
5226385 & ant	1347-7366A1	17059287	R4/4MV	18-7095	18-7201
MIE 340/7.4L					
TODOS	1347-8288A1	17080560	R4/4MV	18-7095	18-7201
MCM 350 MAGNUM/5.7L BRAVO					
B525992-317327	1347-8289A1	—	R4/4MV	18-7095	18-7201
TODOS MIE 350	1347-5326A2	17065977	R4/4MV	18-7072	18-7201
TODOS MCM 370/400	1347-7498A2	17059280	R4/4MV	18-7095	18-7201
MCM 7.4L (BRAVO ONE)	1347-8291A3	17080563	R4/4MV	18-7095	18-7201
MCM 454 7.4L					
6083145-B816540	—	—	H4/4150, R6647A	18-7728	—
MCM 454 MAGNUM					
TODOS (BRAVO ONE)	1347-7498A2	17059280	R4/4MV	18-7095	18-7201
	1347-9863A3	—	R4/4MV	18-7095	18-7201
MCM 502 MAGNUM (BRAVO ONE)					
C878221-D857199	1347-814623A2	—	R4/4MV	18-7095	18-7201
MCM 8.2L	1347-814623A2	—	R4/4MV	18-7095	18-7201

① NO INCLUYE BARRAS DE MEDICIÓN



18-7228
ANTI-DEFLAGRANTE
Reemplaza:
85784A1, 805016A1



18-7229
ANTI-DEFLAGRANTE
Reemplaza:
85785T, 85785-2



18-7230
ANTI-DEFLAGRANTE
Reemplaza:
41639A1, 41639



18-7231
ANTI-DEFLAGRANTE
Reemplaza: 85785A2



18-7232
ANTI-DEFLAGRANTE
Reemplaza:
57882, 57882T



18-7234
ANTI-DEFLAGRANTE
Reemplaza: 805016A1

ESPECIFICACIONES DE ANTI-DEFLAGRANTES DE ALUMINIO ANODIZADO

MOTOR	REF NO.	ALTURA A	ELEMENTO B	CUELLO C	TUBOS VENT*
4 & 6 cil.	18-7228	2.156	1.088	3.120	1
4 & 6 cil.	① 18-7234	2.280	1.550	3.100	0
V-8	18-7229	2.250	1.470	5.050	0
V-8	18-7230	2.250	1.470	5.050	1
V-8	18-7231	2.250	1.470	5.050	2
Altas prest.	18-7232	2.969	2.190	5.050	2

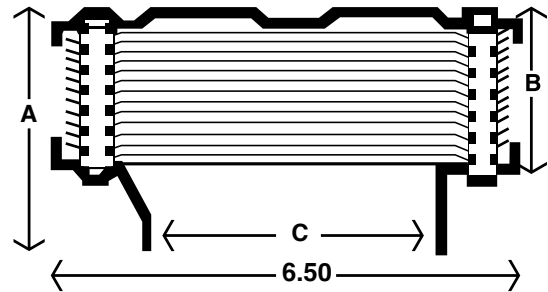

① 7" Diámetro externo * Los tubos de ventilación aceptan manguera 5/8 pulgadas DI

TODAS LAS BOMBAS DE GASOLINA INCLUYEN JUNTA DE MONTAJE

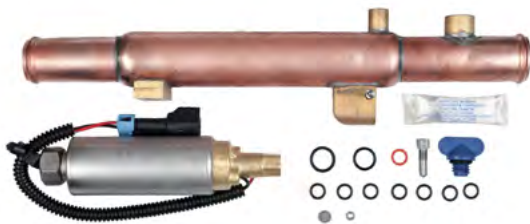

18-8861
BOMBA COMBUSTIBLE CON REFRIGERACIÓN
Reemplaza: 861156A02
Para: GM V-6/ V-8 EFI 0L000000-0M299999



18-8862
BOMBA COMBUSTIBLE CON REFRIGERACIÓN
Reemplaza: 861156A03
Para: GM V-6/ V-8 EFI 0M300000



18-8864
BOMBA COMBUSTIBLE CON REGULADOR
Reemplaza: 866169T01, 866169A01
Para: Gm V-8 con Gen III Modulo refrigeración comb-alta presión



18-8865
BOMBA COMBUSTIBLE
Reemplaza: 866170A01
Para: Gm V-8 con Gen III Modulo refrigeración comb-baja presión



18-8867
BOMBA COMBUSTIBLE
Reemplaza: 861155A6, 861155A5, 805656A6, 805656A5, 805656A2, 805025A2
Para: 4.3L V-6



18-8868
BOMBA COMBUSTIBLE
Terminales con rosca
Reemplaza: 861155A3, 861155A2
Para: 5.0/ 5.7L V-8 & 4.3L



18-7326
BOMBA COMBUSTIBLE ELÉCTRICO
Reemplaza: 805656A2, 805656A6,
805656A5, 805025A2, 861155A6, 861155A5
Para: 1992-93, 1996 F.I. & Carburador 4.3L
con bomba eléctrica en-línea



18-35433
BOMBA COMBUSTIBLE ELÉCTRICO
1 terminal con rosca, 1 terminal conector
Reemplaza: 861156A1
Para: Mercruiser V6 & V8 305/350/377/454/502 EFI (No-rosca)(Reemplaza bomba refrigeración comb.)



18-7266
BOMBA COMB
Identificación D.I. # 41413, M6696
Para: Ford (V-8) 302, 351



18-7267
BOMBA COMB
Identificación D.I. # 41414
Reemplaza: 62092T, 62092, 54552
Para Ford (V-8) 302
(Incluye junta)



18-7274
BOMBA COMB
Identificación D.I. # 41421, M73021
Reemplaza: 86246, 86246A1, 78485, 71646
Para: GM (V-8) 305, 350, 400, 228 / 250 /
255 / 260 / 280



18-7275
BOMBA COMB
Identificación D.I. # 41422
Reemplaza: 86247, 86247T, 86247A2,
78820, 63196, 46860
Para: GM (V-8) 454, 330 / 325 / 350 / 390
(Incluye junta)



18-7278
BOMBA COMB
Identificación D.I. # M60032
Reemplaza: 86234A4, 86234A05,
86234A3,
86234, 77594, 71327, 47585
Para: GM (4 & 6 Cil.) 153, 181, 225, 250,
120 / 140 / 160 / 165 / 470 / 485 / 488
Use filtro 18-7860 & junta 18-0889



18-7282
BOMBA COMB
Identificación D.I. # M60337
Reemplaza: 8M0073435, 861676T09
Para: GM 4 cil. (2.5/3.0L) & Mercruiser 3.7L
Use filtro 18-7784 & junta 18-0889



18-7283
BOMBA COMB
Identificación D.I. # M60600
Reemplaza: 8M0058164, 8M0058164, 97401
Para: GM (V-8) 305, 350, 228 / 230 / 260 / 898
Use junta 18-0889



18-7284
BOMBA COMB
Identificación D.I. # M60315
Reemplaza: 41141A2, 862077A1
Para: GM (V-6) 231, 262, 229
Use filtro 18-7784 & junta 18-0889



18-7288-1
BOMBA COMB
Identificación D.I. #60601
Reemplaza: 812454A1, 862048A1, 812454A3,
97399A2, 97399
Para: En línea (4 cil) 120, 140, 3.0L y 224 CID
7.4L / 454 / 420 / 330



18-35437
BOMBA COMB
Reemplaza: 42725A3, 861676A1,
861676T09, 8M0073435
Para: Mercruiser 3.0L (SN L097000 & Sup)
(Incluye junta)



18-8860
BOMBA COMB
Reemplaza: 861677T
Para: APLICACIONES GM V-8 (454 & 502)
(Incluye juntas)



18-7256
BOMBA COMB
Identificación D.I. # 6790, M3530
Reemplaza: 32722
Para: GM (4 & 6 Cil.) 153, 230, 250, 292

APLICACIÓN BOMBA COMBUSTIBLE

Modelo	CID / # CIL	Intervalo año	Desde		Hasta		Bomba combustible		Filtro
			Número serie	Número serie	#1	#2	bomba		
120	153/L4	1964-1972	1666601	3377340	18-7278	①	—	18-7860	
120	153/L4	1964-1972	1666601	3377340	18-7256	②	—	—	
120	153/L4	1972-1982	3377341	6229717	18-7278	—	—	18-7860	
120	153/L4	1983-1986	6229718	B531853	18-7278	③	—	18-7860	
120			4469866	& Inf	18-7278	—	—	—	
120			4469866	4952700	18-7278	—	—	—	
120			4952701	& Sup	18-7278	—	—	—	
120			5192049	6229717	18-7278	—	—	—	
120/2.5L			6229718	& Sup	18-7278	—	—	—	
120/2.5L			6229718	& Sup	18-7282	—	—	—	
2.5L	153/L4	1987-1989	B531854	BC853255	18-7278	④	—	18-7860	
140 (4 Cil.)	181/L4	1968-1982	2508261	6229717	18-7278	—	—	18-7860	
140 (4 Cil.)	181/L4	1983-1986	6229718	B450800	18-7278	⑤	—	18-7860	
3.0L	181/L4	1987-1989	B450801	C856558	18-7278	⑥	—	18-7860	
140			4460664 & Inf	& Inf	18-7278	—	—	—	
140			4460665	4918569	18-7278	—	—	—	
140			4918570	& Sup	18-7278	—	—	—	
140 (4 Cil.)			5157669	6229717	18-7278	—	—	—	
140/3.0L			6229717 & Inf	& Inf	18-7278	—	—	—	
140/3.0L			6229718 & Sup	& Sup	18-7282	—	—	—	
3.0L/3.0LX			C856559 & Sup	& Sup	18-7282	—	—	—	
140 (6 Cil.)			1538930	1725960	18-7256	—	—	—	
150			1666495	2048046	18-7256	—	—	—	
160			2048022	2770031	18-7278	—	—	—	
165			4471566	4884834	18-7278	—	—	—	
165			5178959 & Sup	& Sup	18-7278	—	—	—	
165/3.7L (4 Cil.)			6916779 & Sup	& Sup	18-7282	—	—	—	
180/3.7-LX (4 Cyl.)			6916779 & Sup	& Sup	18-7282	—	—	—	
175/4.3L (262 CID)			B527955 & Sup	& Sup	18-7284	—	—	—	
185 (229 CID)			6330183 & Sup	& Sup	18-7284	—	—	—	
185 (262 CID)			A331455 & Sup	& Sup	18-7284	—	—	—	
470	224/L4	1976-1984	4208730	6916778	18-7278	—	—	18-7860	
485	224/L4	1980-1982	5685394	6218036	18-7278	—	—	18-7860	
488	224/L4	1983-1984	6170297	6916778	18-7278	⑦	—	18-7860	
140 (6 CIL)	194/L6	1963	1538930	1725960	18-7256	—	—	—	
150	230/L6	1964-1966	1666495	2048046	18-7256	—	—	—	
160	250/L6	1967-1969	2048022	2770031	18-7278	⑧	—	18-7860	
160	250/L6	1967-1969	2048022	2770031	18-7256	⑨	—	—	
165 (6 CIL)	250/L6	1979-1981	2770032	5813433	18-7278	—	—	18-7860	
200 (6 CIL)	250/L6	1969	2453769	2712072	18-7278	—	—	18-7860	
200 GM			6218462	& Sup	18-7283	—	—	—	
200/5.0L GM			B525982	& Sup	18-7283	—	—	—	
185 (4bbl)	229/V-6	1983-1984	6330183	6919655	18-7284	—	—	—	
175	262/V-6	1987	B527955	B773242	18-7284	—	—	—	
185 (2bbl)	262/V-6	1985-1986	A331455	B527954	18-7284	—	—	—	
205	262/V-6	1985-1987	A331455	B775129	18-7284	—	—	—	
205/4.3L-LX (262 CID)			B527955	& Sup	18-7284	—	—	—	
262 MAG EFI (GEN +)	262/V-6	1996-1997	F803800	K999999	18-8867	—	—	—	
4.3L	262/V-6	1988-1992	B773243	D714106	18-7284	—	—	—	
4.3L (GEN II)	262/V-6	1992-1996	D714107	F802999	18-8867	—	—	—	
4.3L (GEN +)	262/V-6	1998-2010	L012009	& Sup	18-8868	—	—	—	
4.3L EFI (GEN +)	262/V-6	1998-2001	L012009	M299999	18-8861	⑩	—	—	
4.3L MPI	262/V-6	2002-2010	M300000	& Sup	18-8862	⑪	—	—	
4.3LH (GEN+)	262/V-6	1998-2002	L010044	M614999	18-8868	—	—	—	
4.3LX	262/V-6	1988-1992	B775130	D714369	18-7284	—	—	—	
4.3LX (GEN II)	262/V-6	1992-1996	D714107	F802999	18-8867	—	—	—	
4.3LX (GEN +)	262/V-6	1996-1997	F803000	K999999	18-8867	—	—	—	
4.3LXH (GEN +)	262/V-6	1996-1997	F803114	K999999	18-8867	—	—	—	
215 (FORD)	302/V-8	1970-1972	2781153	3563181	18-7267	—	—	—	
215 Ford			3085036	& Inf	18-7267	—	—	—	
215 Ford			3258182	& Sup	18-7267	—	—	—	
225 Ford	302/V-8	1973-1974	3385721	4166999	18-7267	—	—	—	
228 MCM & MIE	305/V-8	1977-1978	4765100	5170008	18-7274	—	—	—	
228 MCM & MIE	305/V-8	1979-1982	5170009	6218461	18-7274	—	—	—	
228 MCM & MIE	305/V-8	1979-1982	5170009	6218461	18-7283	⑫	—	—	
888 (FORD)	302/V-8	1971-1977	3108723	4887829	18-7267	—	—	—	
228	305/V-8	1982-1984	6218462	6899268	18-7283	—	—	—	
230 MIE	305/V-8	1981-1987	5907058	B788151	18-7283	—	—	—	
230/5.0L-GM (IB)			B522506	& Sup	18-7283	—	—	—	
230 GM			6218462	& Sup	18-7283	—	—	—	
230/5.0L-LX GM			B525982	& Sup	18-7283	—	—	—	
230	305/V-8	1985-1987	6899269	B773739	18-7283	—	—	—	
5.0L	305/V-8	1988-1995	B774445	F600999	18-7283	—	—	—	
5.0L (GEN +)	305/V-8	1998-2010	L015751	& Sup	18-8868	—	—	—	
5.0L EFI (GEN +)	305/V-8	1998-2001	L012052	M299999	18-8861	⑬	—	—	
5.0L MIE	305/V-8	1988	B788152	C396832	18-7283	—	—	—	
5.0L MPI ALPHA	305/V-8	2002-2010	M300000	& Sup	18-8862	⑭, ⑮	18-8868 ⑯	—	
5.0L MPI BRAVO	305/V-8	2002-2004	M300000	W059999	18-8862	⑰, ⑱	18-8868 ⑲	—	
5.0L MPI BRAVO	305/V-8	2004-2010	W060000	& Sup	18-8864	⑳	18-8865 ㉑	—	
5.0LX	305/V-8	1988-1995	B773740	F600999	18-7283	—	—	—	
898	305/V-8	1977-1982	4762210	6218461	18-7274	㉒	—	—	
898	305/V-8	1977-1982	4762210	6218461	18-7283	㉓	—	—	
898	305/V-8	1983-1984	6218462	6899057	18-7283	—	—	—	
233 FORD			4500860	& Sup	18-7267	—	—	—	
250	350/V-8	1977	4768000	4908849	18-7274	—	—	—	
255	350/V-8	1975-1976	4175500	4767999	18-7274	—	—	—	
255 MIE (GM)	350/V-8	1975-1980	4175500	5907057	18-7274	—	—	—	
255 FORD			3258728	& Sup	18-7267	—	—	—	
255 GM			5195909	& Sup	18-7274	—	—	—	
260	350/V-8	1978-1982	4908850	6218461	18-7274	㉔	—	—	
260	350/V-8	1978-1982	4908850	6218461	18-7283	㉕	—	—	
260	350/V-8	1983-1987	6218461	& Sup	18-7283	—	—	—	
260 MIE	350/V-8	1981-1987	5907058	B788151	18-7283	—	—	—	

① Baja presión de la bomba de elevación

② Refrigeración de la bomba de comb. de alta presión

③ Bomba comb. con cazoleta filtro arriba

④ Bomba comb. con cazoleta filtro abajo

⑤ AC bomba combustible

⑥ Carter bomba comb.

⑦ Bomba comb. mecánica

⑧ Usar si bomba comb. tiene vaso comprobador

⑨ Usar si bomba comb. tiene tubo

⑩ Bomba comb/Kit refrigeración

APLICACIÓN BOMBA COMBUSTIBLE

Model	CID / # CIL	Intervalo años	Desde Número serie	Hasta Número serie	Bomba comb #1	Bomba comb #2	Filtro bomba
260/5.7 GM			B525982	& Sup	18-7283	—	—
260 GM Intraborda			5907058	& Sup	18-7283	—	—
260/5.7L GM (IB)			5907058	& Sup	18-7283	—	—
5.7L-GM			F025000	& Sup	18-7283	—	—
280	350/V-8	1975-1976	4176250	4770199	18-7274	—	—
300MR/TRS GM	350/V-8	1985-1986	6668677	B430367	18-7283	—	—
320 EFI	350/V-8	1987-1989	A543604	C622418	N.L.A	—	—
325-GM			2278747	3640670	18-7275	—	—
330 GM			4623115	& Sup	18-7275	—	—
330 GM/W.B.W.			6083145	& Sup	18-7288-1	—	—
340/7.4L-GM (IB)			5889914	& Sup	18-7288-1	—	—
350 MAG ALPHA	350/V-8	1986-1997	A635178	K999999	18-7823	—	—
350 MAG ALPHA EFI (GEN +)	350/V-8	1996	F800300	K001508	18-7283	—	—
350 MAG ALPHA EFI (GEN +)	350/V-8	1997	K001509	K999999	18-8863	⑩	—
350 MAG BRAVO MPI	350/V-8	1995-1996	F415189	K001500	18-7283	—	—
350 MAG BRAVO MPI	350/V-8	1997	K001501	K999999	18-8863	⑨	—
350 MAG EFI SKI	350/V-8	1994-1997	F215561	K999999	18-8863	⑩	—
350 MAG MPI	350/V-8	1998-2001	L010019	M299999	18-8861	⑩	—
350 MAG MPI ALPHA	350/V-8	2002-2010	M300000	& Sup	18-8862	⑨	18-8868 ①
350 MAG MPI BRAVO	350/V-8	2002-2004	M300000	W059999	18-8862	⑨, ⑩	18-8868 ①
350 MAG MPI BRAVO	350/V-8	2004-2010	W060000	& Sup	18-8864	⑨	18-8865 ①
350 MAG MPI HORIZON	350/V-8	2002-2004	M300000	W059999	18-8862	⑨, ⑩	18-8868 ①
350 MAG MPI HORIZON	350/V-8	2004-2007	W060000	A299999	18-8864	⑨	18-8865 ①
350 MAG MPI HORIZON MIE	350/V-8	1999-2001	L304700	M299999	18-8861	⑨	— ①
350 MAG MPI HORIZON MIE	350/V-8	2002-2004	M300000	M398371	18-8862	⑨, ⑩	18-8868 ①
350 MAG MPI HORIZON MIE	350/V-8	2004-2007	M398372	A089999	18-8864	⑨	18-8865 ①
350 MAG MPI MIE	350/V-8	1998-2001	L002008	M299999	18-8861	⑩	—
350 MAG MPI MIE	350/V-8	2002-2004	M300000	M398371	18-8862	⑨, ⑩	18-8868 ①
350 MAG MPI MIE	350/V-8	2004-2007	M398372	A089999	18-8864	⑨	18-8865 ①
350 MAG MPI MIE	350/V-8	1998-2001	L002008	M299999	18-8861	⑩	—
350 MAG MPI MIE	350/V-8	2002-2004	M300000	M398371	18-8862	⑨, ⑩	18-8868 ①
350 MAG MPI MIE	350/V-8	2004-2007	M398372	A089999	18-8864	⑨	18-8865 ①
350 MAG MPI SKI	350/V-8	1995-1996	F350583	F799999	18-7283	—	—
350 MAG MPI SKI (GEN +)	350/V-8	1998-2001	L002600	M299999	18-8861	⑩	—
350 MAG MPI SKI (GEN +)	350/V-8	2002-2007	M300000	A089999	18-8862	⑩	18-8868 ①
350 MAG SKI	350/V-8	1991-1997	D505450	K999999	18-7283	—	—
350 GM			3780450	& Sup	18-7275	—	—
(MAG-TOURNEY SKI)			D505450	& Sup	18-7283	—	—
370 TRS-GM			6721528	& Sup	18-7288-1	—	—
390-GM			2781129 - 2825059	2825059	18-7275	—	—
5.7L	350/V-8	1988-1997	B773305	K999999	18-7283	—	—
5.7L (GEN +)	350/V-8	1998-2010	L010037	& Sup	18-8868	—	—
5.7L EFI	350/V-8	1995-1996	F225560	K001505	18-7283	—	—
5.7L EFI	350/V-8	1997-2001	K001506	M299999	18-8861	⑩	—
5.7L MIE	350/V-8	1988-1997	B788152	K999999	18-7283	—	—
5.7L MIE (GEN +)	350/V-8	1998-2010	L002003	& Sup	18-8868	—	—
5.7L MPI HORIZON MIE	350/V-8	2008-2010	A090000	& Sup	18-8864	⑨	18-8865 ①
5.7L MPI MIE	350/V-8	2008-2010	A090000	& Sup	18-8864	⑨	18-8865 ①
5.7L MPI SKI	350/V-8	2008-2010	A090000	& Sup	18-8862	⑨, ⑩	18-8868 ①
5.7L SKI	350/V-8	1985-1997	A338553	K999999	18-7283	—	—
5.7L SKI (GEN +)	350/V-8	1998-2010	L002005	& Sup	18-8868	—	—
5.7LX	350/V-8	1996-1997	F601000	K999999	18-7283	—	—
5.7LX BRAVO EFI (GEN +)	350/V-8	1996	F800300	K001508	18-7283	—	—
5.7LX BRAVO EFI (GEN +)	350/V-8	1997	K001509	K999999	18-8863	⑩	—
5.7LX EFI	350/V-8	1996	F752400	K001505	18-7283	—	—
5.7LX EFI	350/V-8	1997	K001506	K999999	18-8863	⑩	—
5.7 GM (SKI)			B514627	& Sup	18-7283	—	—
5.7L BRAVO (GM)350			B525982	& Sup	18-7283	—	—
BLACK SCORPION SKI	350/V-8	1997	K040001	K999999	18-8863	⑨, ⑩	—
BLACK SCORPION SKI	350/V-8	1998-2001	L000000	L679175	18-8861	⑨, ⑩	—
BLACK SCORPION SKI	350/V-8	2001-2007	L679176	W698432	18-8861	⑨, ⑩	18-8868 ①
SCORPION 350	350/V-8	2008-2010	W698433	& Sup	18-8861	⑨, ⑩	18-8868 ①
SCORPION 350 EC	350/V-8	2009-2010	W698433	& Sup	18-8864	⑨	18-8864 ①
233 (FORD)	351/V-8	1975-1977	4173000	4902304	18-7267	—	—
255 (FORD)	351/V-8	1973-1974	3258728	4175499	18-7267	—	—
377 MAG	377/V-8	2008-2010	A300000	& Sup	18-8864	⑨	18-8865 ①
377 SCORPION MCM	377/V-8	1999-2005	L416146	M907201	18-8861	⑩	—
377 SCORPION SKI	377/V-8	1997-1998	K00656	L600314	18-8861	⑩	—
MX 6.2L MPI	377/V-8	2000-2001	L680003	M299999	18-8861	⑩	—
MX 6.2L MPI	377/V-8	2002-2004	M300000	W059999	18-8862	⑨, ⑩	18-8868 ①
MX 6.2L MPI	377/V-8	2004-2007	W060000	A299999	18-8864	⑨	18-8865 ①
MX 6.2L MPI HORIZON	377/V-8	2002-2004	M300000	W059999	18-8862	⑨, ⑩	18-8868 ①
MX 6.2L MPI HORIZON	377/V-8	2004-2007	W060000	A299999	18-8864	⑨	18-8865 ①
MX 6.2L MPI HORIZON MIE	377/V-8	2002-2004	M300000	M398394	18-8862	⑨, ⑩	18-8868 ①
MX 6.2L MPI HORIZON MIE	377/V-8	2004-2010	M398395	& Sup	18-8864	⑨	18-8865 ①
MX 6.2L MPI MIE	377/V-8	2002-2004	M300000	M398394	18-8862	⑨, ⑩	18-8868 ①
MX 6.2L MPI MIE	377/V-8	2004-2010	M398395	& Sup	18-8864	⑨	18-8865 ①
MX 6.2L MPI SKI	377/V-8	2002-2010	M317000	& Sup	18-8862	⑨, ⑩	18-8868 ①
MX 6.2L BLACK SCORPION SKI	377/V-8	2001	L670015	L679175	18-8861	⑩	—
MX 6.2L BLACK SCORPION SKI	377/V-8	2001-2007	L679176	W698432	18-8861	⑨, ⑩	18-8868 ①
SCORPION 377	377/V-8	2008-2010	W698433	& Sup	18-8861	⑨, ⑩	18-8868 ①
SCORPION 377 HO EC	377/V-8	2009-2010	A091488	A092170	18-8864	⑨	18-8865 ①
325	427/V-8	1969-1972	2278747	3780449	18-7275	—	—
330	454/V-8	1977-1981	4623115	6083144	18-7275	—	—
330 WITH B/W	454/V-8	1982-1987	6083145	B816540	18-7288-1	—	—
340 MIE	454/V-8	1981-1987	5889914	B788365	18-7288-1	—	—
350 MIE	454/V-8	1974-1976	3780450	4623109	18-7275	—	—
370 TRS	454/V-8	1978-1987	4179554	B714586	18-7288-1	—	—
400 TRS	454/V-8	1980-1986	4179554	B457644	18-7288-1	—	—
420	454/V-8	1987-1989	A398941	B622418	18-7288-1	—	—
425-GM			A398941	& Sup	18-7288-1	—	—
425	454/V-8	1990-1992	B622419	D725499	18-7288-1	—	—
425 (GEN V)	454/V-8	1992-1993	D763855	D937011	18-8860	—	—
440 TRS	454/V-8	1983-1986	4179554	B485220	18-7288-1	—	—

- ① Baja presión de la bomba de elevación
- ② Refrigeración de la bomba de comb. de alta presión
- ③ Bomba comb. con cazoleta filtro arriba
- ④ Bomba comb. con cazoleta filtro abajo
- ⑤ AC Bomba combustible
- ⑥ Carter bomba combustible
- ⑦ Bomba combustible mecánica
- ⑧ Usar si bomba comb tiene vaso comprobador
- ⑨ Usar si bomba comb. tiene tubo
- ⑩ Bomba combustible/Kit refrigeración

APLICACIÓN BOMBA COMB

Modelo	CID / # CIL	Intervalo Año	Desde Número serie	Hasta Número serie	Bomba comb #1	Bomba comb #2	Filtro bomba
450	454/V-8	1995-1996	F347100	F347277	18-8860	—	—
454 MAG ALPHA	454/V-8	1986-1988	A631894	B785148	18-7288-1	—	—
454 MAG BRAVO GM			B840126	& Sup	18-7288-1	—	—
454 MAG BRAVO	454/V-8	1988-1992	A631894	B785148	18-7288-1	—	—
454 MAG BRAVO	454/V-8	1992-1997	D805069	K999999	18-8860	—	—
454 MAG EFI	454/V-8	1994-1996	F115700	F802349	18-8860	—	—
454 MAG EFI SKI	454/V-8	1995-1996	F215800	F820099	18-8860	—	—
454 MAG MPI	454/V-8	1996	F802350	K147349	18-8860	—	—
454 MAG MPI	454/V-8	1997	K147350	K999999	18-8861	Ⓜ	—
454 MAG MPI	454/V-8	1998-2001	L010029	M024999	18-8861	Ⓜ	—
454 MAG MPI HORIZON MIE	454/V-8	1998-2001	L002200	L674000	18-8861	Ⓜ	—
454 MAG MPI SKI	454/V-8	1996-1997	F820100	K999999	18-8860	—	—
470			5097479	& Inf	18-7278	—	—
470			5097480	& Sup	18-7278	—	—
470			5520115	6218036	18-7278	—	—
470			6218037	& Sup	18-7278	—	—
485			5685394	& Sup	18-7278	—	—
488			6170297	& Sup	18-7278	—	—
525SC	454/V-8	1992-1999	D725809	L415623	18-8860	—	—
7.4L BRAVO	454/V-8	1988-1991	B771113	D603117	18-7288-1	—	—
7.4L BRAVO	454/V-8	1992-1997	D603118	K999999	18-8860	—	—
7.4L EFI MIE	454/V-8	1996-1997	F874815	K999999	18-8863	Ⓜ	—
7.4L MIE	454/V-8	1988-1992	B788366	D715493	18-7288-1	—	—
7.4L MIE	454/V-8	1992-1997	D715494	K999999	18-8860	—	—
7.4L MPI	454/V-8	1998-2001	L010003	M024330	18-8861	Ⓜ	—
7.4L MPI MIE	454/V-8	1995-1997	F563052	K147349	18-8860	—	—
7.4L MPI MIE	454/V-8	1997	K147350	K999999	18-8863	Ⓜ	—
7.4L MPI MIE	454/V-8	1997-2001	L002006	L674613	18-8861	Ⓜ	—
7.4LX BRAVO EFI	454/V-8	1996-1997	F820000	K999999	18-8863	Ⓜ	—
7.4LX BRAVO MPI	454/V-8	1996-1997	F602010	K999999	18-8860	—	—
7.4L W/HURTH (IB)			C391564	& Sup	18-7288-1	—	—
390	482/V-8	1969-1970	2781129	2825059	18-7275	—	—
496 MAG & HO	496/V-8	2001-2004	M025000	W059999	18-8862	Ⓜ, Ⓜ	18-8868 Ⓜ
496 MAG & HO	496/V-8	2004-2010	W060000	& Sup	18-8864	Ⓜ	18-8865 Ⓜ
8.1S MPI MIE & HO	496/V-8	2001-2004	M026000	W089999	18-8862	Ⓜ, Ⓜ	18-8868 Ⓜ
8.1S MPI MIE & HO	496/V-8	2004-2010	W090000	& Sup	18-8864	Ⓜ	18-8865 Ⓜ
465	502/V-8	1992-1994	D456155	F213244	18-7275	—	—
500	502/V-8	1994-1998	F213293	L001772	18-7275	—	—
502 MAG BRAVO	502/V-8	1992-1993	D824589	F114528	18-8860	—	—
502 MAG EFI	502/V-8	1993-1995	D840650	F802599	18-8860	—	—
502 MAG MPI	502/V-8	1996	F802600	K147349	18-8860	—	—
502 MAG MPI	502/V-8	1997	K147350	K999999	18-8863	Ⓜ	—
502 MAG MPI	502/V-8	1998-2001	L017000	M024999	18-8861	Ⓜ	—
600SC	502/V-8	1992-2000	D725676	L601186	18-8860	—	—
8.2L MAG & HO	502/V-8	2010	A340340	& Sup	18-8864	Ⓜ	18-8865 Ⓜ
8.2L MAG & HO MIE	502/V-8	2010	A350802	& Sup	18-8864	Ⓜ	18-8865 Ⓜ
8.2L MIE	502/V-8	1993-1996	D857200	F819619	18-8860	—	—
8.2L MPI MIE	502/V-8	1996-1997	F819620	K147349	18-8860	—	—
8.2L MPI MIE	502/V-8	1997	K147350	K999999	18-8863	Ⓜ	—
8.2L MPI MIE	502/V-8	1998-2001	L002450	L674200	18-8861	Ⓜ	—

- Ⓜ Baja presión de la bomba de elevación
- Ⓜ Refrigeración de la bomba de comb. de alta presión
- Ⓜ Bomba comb. con cazoleta filtro arriba
- Ⓜ Bomba comb. con cazoleta filtro abajo
- Ⓜ AC Bomba comb.
- Ⓜ Carter bomba comb
- Ⓜ bomba comb mecánica
- Ⓜ usar si bomba comb. tiene vaso comprobador
- Ⓜ usar si bomba comb. tiene tubo
- Ⓜ bomba comb/Kit refrigeración

SEPARADOR AGUA/COMBUSTIBLE

Los filtros sierra separan hasta un 99.8% de agua emulsionada en la gasolina. Los filtros de 10 micrones separan hasta un 90% de impurezas y pueden ser aplicados para un consumo máximo de 350 litros por hora.

Están indicados para prevenir daños en los motores intraborda y fueraborda de inyección.

- DISEÑO UNIVERSAL -

RECAMBIO DIRECTO PARA MERCURY Y YAMAHA

SOPORTE DEL SEPARADOR DE AGUA/COMBUSTIBLE



Tipo de soporte	Ref #	Reemplaza	Tipo soporte	Ref #	Reemplaza
1/4" Acero inox	18-7777		1/4" Aluminio	18-7853-1	Mercury 89876A3, 55481, 89876
3/8" Acero inox	18-7776		3/8" Aluminio	18-7775	

KITS SEPARADORES AGUA/COMBUSTIBLE



KITS FILTROS 21 MICRONES - PARA MOTORES CARBURADOS

Tipo kit	Ref #	Capacidad de filtrado	Contiene	Reemplaza
1/4" Aluminio (Filtro corto)	18-7848-1 1878481E	21	1 - 18-7844 filtro & 1 18-7853-1 soporte 2 - 18-4256 1/4" tapones	Mercury - 35-807172A4, Q4, 35-60494A4, 35-805369A4, 35-57250A1, 35-55501A1, 35-52456A1, 35-60494A1, 52444
1/4" Pack aluminio Contiene filtro recambio	18-7848-2	21	2 - 18-7844 filtro & 1 18-7853-1 soporte 2 - 18-4256 1/4" tapones	
1/4" Aluminio (Filtro alto)	18-7852-1	21	1 - 18-7845 filtro & 1 18-7853-1 soporte 2 - 18-4256 1/4" tapones	
1/4" Pack aluminio Contiene filtro recambio	18-7852-2	21	2 - 18-7845 filtro & 1 18-7853-1 soporte 2 - 18-4256 1/4" tapones	
3/8" Aluminio (Filtro alto)	18-7775-1	21	1 - 18-7845 filtro & 1 18-7775 soporte 2 - 18-4264 3/8" tapones	
1/4" Acero inox (Filtro alto)	18-7777-1	21	1 - 18-7845 filtro & 1 18-7777 soporte 2 - 18-4256 1/4" tapones	
3/8" Stainless Steel (Filtro alto)	18-7776-1	21	1 - 18-7845 filtro & 1 18-7776 soporte 2 - 18-4264 3/8" tapones	

KIT FILTROS 10 MICRONES PARA MOTORES DE INYECCIÓN



tipo kit	Ref #	Capacidad de filtrado	Contiene
1/4" Aluminio (Filtro corto)	18-7983-1	10	1 - 18-7944 filtro & 1 18-7853-1 Soporte • 2 - 18-4256 1/4" Tapones
1/4" Aluminio Bonus Pack (Contiene filtro de repuesto)	18-7983-2	10	2 - 18-7944 filtro & 1 18-7853-1 Soporte • 2 - 18-4256 1/4" Tapones
1/4" Aluminio (Filtro largo)	18-7982-1	10	1 - 18-7945 filtro & 1 18-7853-1 Soporte • 2 - 18-4256 1/4" Tapones
1/4" Aluminio Bonus Pack (Contiene filtro de repuesto)	18-7982-2	10	2 - 18-7945 filtro & 1 18-7853-1 Soporte • 2 - 18-4256 1/4" Tapones
1/4" Aluminio (Filtro alta capacidad)	18-7966-1	10	1 - 18-7866 filtro & 1 18-7853-1 Soporte • 2 - 18-4256 1/4" Tapones
3/8" Aluminio (Filtro alto)	18-7986-1	10	1 - 18-7945 filtro & 1 18-7775 Soporte • 2 - 18-4264 3/8" Tapones
1/4" Acero inox (Filtro largo)	18-7984-1	10	1 - 18-7945 filtro & 1 18-7777 Soporte
3/8" Acero inox (Filtro largo)	18-7985-1	10	1 - 18-7945 filtro & 1 18-7776 Soporte • 2 - 18-4264 3/8" Tapones
1/4" Aluminio (Filtro alto)	18-79912	10	1 - 18-79911 & 1 - 18-7853-1



KITS FILTROS 10 MICRONES CON VASO DECANTADOR

El vaso transparente Sierra AquaVue™ se usa para fueraborda e instalaciones en cubierta.

El vaso antiinflamable se usa para instalaciones bajo cubierta.

Los filtros con vaso decantador transparente o metálico permiten drenar el agua, alargando la vida útil del elemento filtrante.

Tipo kit	Ref #	Capacidad de filtrado	Contiene
1/4" Aluminio c/ cazoleta de desagüe	18-7951	10	1 - 18-7919 filtro & 1 18-7853-1 soporte 1 - 18-7924 vaso metálico 2 - 18-4256 1/4" tapones
1/4" Acero inoxidable c/ cazoleta de desagüe	18-7938	10	1 - 18-7919 filtro & 1 18-7777 soporte 1 - 18-7924 vaso metálico 2 - 18-4256 1/4" tapones

**SOPORTE COMPACTO Y KIT SEPARADOR -
PARA PEQUEÑOS FUERABORDAS Y APLICACIONES DE AGUA DULCE**



**18-7774
SOPORTE ALUMINIO CONTACTO**



**18-6999
SOPORTE
PARA FILTRO**
Para todos los motores mercruiser 305 y 350



**18-7965-1
10 MICRON COMPACTO
KIT SEPARADOR**
Contiene:
1 - 18-7774 soporte
1 - 18-7865 filtro

FILTROS DE REPUESTO



DISEÑO UNIVERSAL - REPUESTO DIRECTO PARA MERCURY

FILTROS DE REPUESTO 10 MICRONES			FILTROS DE REPUESTO 21 MICRONES		
Ref #	Descripción	Reemplaza	Ref #	Descripción	Reemplaza
18-7944	corto - 3.875"	35-807172, 35-802893Q, 35-806771, 35-8053691, 35-805369, 35-604941, 35-60494, 35-57250, 35-55501, 35-52456	18-7844 / 187844E	Corto - 3.875"	35-807172, 35-802893Q
18-7945 187945E	Largo - 8.5"	35-802893Q, 35-806771, 35-8053691, 35-805369, 35-604941, 35-60494, 35-57250, 35-55501, 35-52456	18-7845	Largo - 4.35"	35-807172, 35-806771, 35-8053691, 35-60494A4, 35-604941, 35-57250, 35-55501
18-7866	Alta capacidad - 6"				
18-7865	Compacto 10 Micrones				
18-79911	Largo - 8.5"	35-8M0079962			



**FILTROS DE REPUESTO 10
MICRONES Y KITS CON VASO
DECANTADOR**



FILTROS DE REPUESTO			REPUESTO VASOS DECANTADORES	
Ref #	Descripción	Reemplaza	Ref #	Descripción
18-7919 810001	Elemento filtrante	35-809097, 35-8M0103095 Racor S3213	18-7924	Vaso metálico
18-7920	Elemento filtrante	Mercury 35-809099 Racor S3214	KITS FILTROS CAZOLETAS	
18-7947	Elemento filtrante	Racor S3240	Ref #	Descripción
18-7948	Elemento filtrante Para - 320RRAC01	35-886638 Racor S3227	18-7929	Filtro y Vaso metálico Tipo mercury Contiene: 18-7919 filtro, 18-7924 cazoleta
18-7949	Elemento filtrante Para - 660RRAC02	Racor S3232	18-7943	Filtro & Vaso metálico Contiene: 18-7920 filtro, 18-7924 cazoleta
			18-7969	Filtro & Vaso metálico Contiene: 18-7948 filtro, 18-7924 cazoleta



18-7919 / 810001
FILTRO SEPARADOR
GASOLINA AGUA
Reemplaza: Mercruiser 35-809097,
35-8M0103095
y Racor™ S3213
Para elementos filtrantes con decantador



18-8955
TAPA DEL SEPARADOR
AGUA/COMBUSTIBLE
Para: 18-7944 & 18-7945 Tamaño filtro



18-7784
FILTRO COMBUSTIBLE
Reemplaza:
Mercruiser 35-11004A1, 35-803897Q1
Para: 2.5L/3.0L(6229718 & posteriores), Todos MC224 CID
(6218037 & posteriores), Todos GM 262 CID (A331455 &
posteriores) con bombas de combustible de carter



18-7977
"GEN III SISTEMA DE
FILTRO COMB.
REFRIGERACIÓN COMB."
Reemplaza: 35-866171A01
Para: 350 Mag MPI Alpha/Bravo, 350 Mag MPI Horizon Alpha/
Bravo, 350 Mag MPI Horizon MIE, 350 Mag MPI MIE, 496 MAG,
496 MAG H.O., 5.0 MPI Alpha/Bravo, 8.1L Inboard, 8.1L Inboard
H.O., MX 6.2L MPI Alpha/Bravo, MX 6.2L MPI Horizon Alpha/
Bravo, MX 6.2L MPI Horizon MIE, MX 6.2L MPI MIE



18-7964
FILTRO KIT TRANSMISIÓN
Reemplaza: 35-815419, 8791014241,
879194241, 35-813405A1, 35-813405,
FI9608751, FFF001138
Para: Mercruiser V-8 Intraborda con transmisión Hurt



18-7855
FILTRO COMBUSTIBLE
Reemplaza: 1397-2150
Rochester Carb entrada



18-7717
FILTRO ELEMENTO
Reemplaza: 35-93568
Para: Carburadores Rochester 2 bbl & 4 bbl



18-7859
FILTRO COMBUSTIBLE
Reemplaza: 35-53336,
3302-9033, 35-53336Q
Para: Mayoría GM In línea 4 & 6 cilindro, Ford & Gm
V-8's hasta 400 HP y todos Mercruiser 224 CID



18-7721
FILTRO COMBUSTIBLE
Reemplaza: 35-864572
Todos motores MPI & EFI con bomba de empuje, 8.1L &
496cid, para 3/8" DI línea combustible



18-7860
FILTRO COMBUSTIBLE
Reemplaza: 35-49088A2,
35-49088Q2, 35-49088
FI8390006
(Usado en bomba combustible 18-7278)
Para: En línea 4 & 6 cilindros motores



18-7869
FILTRO COMBUSTIBLE
Usa filtro 18-7859
Reemplaza: 1397-8767, 1397-8545
Para:

Modelo/HP	Serie #
GM 2.5L/3.0L	6229718 & post
GM 5.0L/5.7L	6218462 & post
Todos 205	A331455 & post
228 HP	6021784 & post
330 HP	6083145 & post
GM 255	590768 & post
5.7L SKI 340,230 & 260 Intrabordas	TODOS



18-7873
FILTRO COMBUSTIBLE
Reemplaza: 35-808275
Para: Modelos D7.3/270 Bravo & MIE Diesel
Motores 1994-96



18-7715
FILTRO COMBUSTIBLE
Reemplaza: 35-892665.
Para: Mercruiser V-8 Gen III



18-79901
VST FILTRO
Reemplaza: 66L-13915-00-00
Para: 454 EFI(GenV) GM 1994-96
454 EFI (SKI)(Gen V) GM 1995
454 Mag Bravo MPI (Gen VI) GM 1996-97
454 Mag MPI (SKI)(Gen VI) GM 1996-97
502 EFI (Gen V) GM 1993-95
502 Mag MPI (Gen VI) GM 1996
7.4L MIE MPI (LH) Gen V GM 1995-96
7.4L MIE MPI (LH) Gen VI GM 1996-97
7.4LX Bravo MPI (Gen V) GM 1996
7.4LX Bravo MPI (Gen VI) GM 1996-97
8.2L MIE MPI (LH) Gen VI GM 1996-97



18-6457
POLEA PLÁSTICO
Reemplaza: 807757T
3" DE Serpentin para ancho de correa 13/16" ,
Para último modelo motores GM V6 & V8



18-3506
BOMBA DE CIRCULACIÓN
Reemplaza: 46-879194401
Para: V6 MCM SN: 1A063240 (2007), Nuevos 4.3L sin agujero bypass agua
- ACTUAL



18-3593
BOMBA AGUA
Reemplaza: 884727, 884727001, 880817, 814755, 65142A1, 65142, 52353, 37369, 35957, F2774666, FI1100785, FI1001079
Último Modelo 4 cil GM requieren adaptador de manguera



18-3575
BOMBA CIRCULACIÓN AGUA (Bi-Direccional)
Replaces: 65142A1, 884727001, 844727, 880817, 814755, 65142, 52353, 37369, 33957, F2774666, FI1100785, FI1101079
Para: GM En línea (4 & 6 Cil.)



18-3577-1
BOMBA AGUA CIRCULACIÓN (Bi-Direccional)
Reemplaza: 67859, 17670, 811573, 850454, 8504541, 878342, 850454002, 59972, 54534, 49139, F6269358, FI1100997, FI1101053
Para: bloques grandes GM



18-3573
BOMBA AGUA CIRCULACIÓN
Todos 8.1L bloques grandes GM
Reemplaza: 883514, 883925
Para motores con tapa distribución de plástico



18-3584
BOMBA AGUA CIRCULACIÓN
Reemplaza: Mercruiser 71683A1, 883885, 71683, 58086, 56879
Mercruiser 215 to 255 & 888
Para: Motores Ford bloques pequeños V-8.



18-3599-1
BOMBA AGUA CIRCULACIÓN
Reemplaza: Mercruiser 60658, 811841, 850399, 8503991, 17437, 878341, 850399002, 54793, 52226, 37951, 35341, FI1101292, FI1101208, FI1100742
Para motores GM V-6 & bloques pequeños V-8



18-3007
IMPULSOR
Reemplaza: 47-89983, 4789983T
Para 60 HP



18-3016-1
KIT IMPULSOR
Con junta
Reemplaza: 47-862232A2, 8M0104229
Para: Último modelo Bravo & High Performance. Incluye 350 Mag., 4.3L., 496 Mag., 5.0L., 8.1S y MX 6.2L



18-3017
18-3017S
IMPULSOR
Reemplaza: 47-89984, 47-899842, 47-89984T3, 47-89984T4, 47-899844, 47-30221, 47-65960, 47-85460
Para todos #1, R, MR, Alpha Units hasta S/N D494568.
Además para bomba salada: 190 IB S/N 1564539-1720903
225 IB S/N 1539620-2278646



18-3056
18-3056S
IMPULSOR
Reemplaza: 47-43026-2
Para Alpha I-Generation 2 S/N D494569 & encima
Mercruiser Vazer



















18-3087
IMPULSOR
Reemplaza: Colas Bravo antiguas: 47-59362, 47-59362T

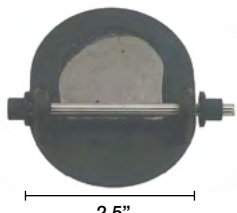

18-3109
TUBO GUIA
Reemplaza: 23-29804, 23-29804T, 23-52928
(use con 18-3116 alojamiento)



18-3110
CASQUILLO
Reemplaza: 26-38970, 26-36557A1, 26-29677
(Ref 18-3116 alojamiento)

 <p>18-3114 CASQUILLO IMPULSOR Reemplaza: 48752, 48752T (Incluido en 18-3116)</p>	 <p>18-3117 PLATINA IMPULSOR Reemplaza: 32435, 324351, 30605 Para #1 Unidades hasta S/N D494568</p>	 <p>18-3122 PLATINA IMPULSOR Reemplaza: 817276, 8172761, 8172763 Para Alpha I - Generation 2 S/N D494569 & ant</p>		
 <p>18-3350 PLATINA DESGASTE Reemplaza: 72778, 94576</p>	 <p>18-3351 PLATINA DESGASTE Reemplaza: 72777, 94916</p>	 <p>18-3293 CHAVETA Reemplaza: 28-43037</p>		
 <p>18-3151 ALOJAMIENTO Reemplaza: 816597</p>	 <p>18-3417 BASE BOMBA AGUA Reemplaza: 46-57234A1</p>	 <p>18-3420 BASE BOMBA AGUA Reemplaza: 46-44292A3, 46-44292Q03, 46-44292T1</p>		
 <p>18-3421 BASE BOMBA AGUA Reemplaza: 46-48748A1</p>	 <p>18-3116 BOMBA AGUA ALOJAMIENTO Reemplaza: 46-96418, 46-96148A1, 46-96148T1, 46-64141A1, 46-48743A1</p>	 <p>Pack. de 2 6.125" 2.360" 18-2732 18-2732-9① VÁLVULA DE ESCAPE ANTI-RETORNO Reemplaza: 807166A3</p>		
 <p>3.175" 2.5" 18-2733 VÁLV. ESCAPE ANTI-RETORNO Reemplaza: 92802, 99370A2</p>	 <p>3.780" 3" 18-2727 VÁLVULA DE ESCAPE ANTI-RETORNO Reemplaza: 60930</p>	 <p>18-3220 TUBO DE AGUA Reemplaza: 32-54236 Para #1 -R/MR/Alpha</p>	 <p>18-3221 TUBO DE AGUA Reemplaza: 32-814384, 32-860220 Para Gen II</p>	
 <p>18-3222 TUBO DE AGUA Reemplaza: 23-816583 Para Gen II</p>	<p>Pack de 5</p>  <p>18-3226 18-3226-9① TORNILLO BOMBA IMPULSOR Reemplaza: 10-30720 Para R unidades</p>	<p>Pack de 5</p>  <p>18-3227 18-3227-9① CLAVIJA BASE BOMBA Reemplaza: 17-35973 Para R/MR, Alpha I</p>	<p>Pack de 5</p>  <p>18-3229 18-3229-9① TORNILLO Reemplaza: 10-28668 Para MR/Alpha</p>	 <p>18-3197 TORNILLO Reemplaza: 10-76156, 10-67373</p>

① Precio por pack



18-3160
BOMBA AGUA MAR, BRONCE
Reemplaza: 46-862914A13
Use impulsor 18-3016-1



18-3600
BOMBA AGUA MAR
Reemplaza: 46-72774A32, 46-72774A11, 46-73823A7, 46-63450A2, 46-59112A2
Para: Motores V8 con V-Belt y 2 piezas bomba
Use kit reparador 18-3155



18-36001
BOMBA AGUA MAR
Reemplaza: 46-807151A12
Para: Motores V6 & V8 con correa y 1 pieza bomba
Use kit reparador 18-3237



18-3155
KIT REPARACIÓN BOMBA AGUA
Reemplaza: 47-72774A89
Para: Bravo bomba agua mar con 2 piezas alojamiento



18-3216
KIT IMPULSOR
Reemplaza: 47-59362A4
Para: 1996-97 7.4L MIE MPI(LH) Gen VI GM 454 V8, 1996-97, 7.4L TBI MIE(LH) Gen VI GM 454 V8, 1996-97 8.2L MIE MPI(LH) Gen VI GM 502 V8.



18-3318
KIT BOMBA AGUA
Reemplaza: 47-59362Q08
Para: 1 plástico y 2 piezas cuerpos bomba



18-3237
KIT REPARACIÓN IMPULSOR
Para: Bravo I, II, III (1988 & sup) B664190 & sup se adapta a bravo con alojamiento de una pieza
-CONTIENE -

Ref #	Desc.	O.E. #	Cant.
18-3087	Impulsor	47-59362	1
18-3350	Plat. desg.	94576	1
18-7163	Aro tórico	25-33465	1



18-3214
KIT REPARACIÓN IMPULSOR
Reemplaza: 47-43026T6, T8, T11
Alpha I - Generation II
S/N D494569 & superiores
Mercuriser Vazer
Para similares Kit con alojamiento superior, order 18-3147

① 18-3214D

-CONTIENE -

Ref #	Desc.	O.E. #	Cant.
18-2564	Junta impulsor	22-43033-1, 27-43033-1	1
18-2565	Junta impulsor	27-43047-1	1
18-2566	Junta impulsor	27-817277	1
18-2944	Arandela	12-19183	1
18-3056	Impulsor	47-43026-1, 47-43026-2	1
18-3122	Platina impulsor	817276	4
18-7420	Aro tórico	25-21836	1



18-3217
KIT IMPULSOR
Para #1 Units hasta S/N D494568
(Similar a #46-96148A5 sin base ni alojamiento)

① 18-3217D

-CONTIENE -

Ref #	Desc.	O.E. #	Cant.
18-3109	Tubo agua	23-29804	1
18-3017	Impulsor	47-89984	1
18-2919	Junta	27-42631-1	1
18-3110	Casquillo	26-38970	1
18-2945	Reten	12-19183	2
18-2826	Junta	27-85610-1	1
18-2914	Junta	27-85608-1	1
18-2915	Junta	27-85609-1	1
18-2944	Junta	26-45577	1
18-3117	Platina	32435	1
18-7158	Aro tórico	25-30613	1
18-7162	Aro tórico	25-33145	1
18-7173	Aro tórico	25-30224	1
18-7176	Aro tórico	25-90011	1
18-2801	Junta bomba agua	27-32438	1
18-7196	Aro tórico	25-38099	1
18-7426	Aro tórico	35-30271	1



18-3150
KIT BOMBA AGUA
Reemplaza: 46-807151A14, 46-807151A7
Para: Bravo



18-3309D
18-3309
KIT BOMBA AGUA
Para: Bravo
-CONTIENE -

Ref #	Desc.	O.E. #	Cant.
18-3350	Platina desgaste	94576	1
18-3351	Platina desgaste	94916	1
18-3087	Impulsor	47-59362	1
18-0386	Junta cuerpo	27-94914	2
18-0916	Junta bomba agua	27-805215-1	1



18-3147
KIT BOMBA AGUA
Reemplaza: 817275T4, 817275K05
Para: Gen II-inf s/n D469859 y sup
Para similares kit sin alojamiento superior, order 18-3214

-- CONTIENE --

Ref #	Desc.	O.E. #	Cant.
18-3109	Tubo guía	23-29804	1
18-3017	Impulsor	47-89984	1
18-3116	alojamiento	46-96148A1	1
18-2919	Junta base bomba	27-42631-1	1
18-3110	Casquillo	26-38970	1
18-2945	Junta tapón de vaciado	26-20260, 12-19183	2
18-2826	Junta base bomba agua	27-85610-1	1
18-2914	Junta inf. bomba a platina desgaste	27-85608-1	1
18-2915	Junta sup. bomba a platina desgaste	27-85609-1	1
18-2944	Retén	26-45577	1
18-3117	Platina	32435	1
18-7158	Aro tórico	25-30613	1
18-7162	Aro tórico	25-33145	1
18-7173	Aro tórico	25-30224	1
18-7176	Aro tórico	25-90011	1
18-2801	Junta bomba agua	27-32438	1
18-7196	Aro tórico	25-38099	1
18-7426	Aro tórico	35-30271	1



**18-3517
KIT BOMBA AGUA
Sin base**

Reemplaza: 46-96148A5, 46-60367A1, 46-96148A8

-- CONTIENE --

Ref #	Desc.	O.E. #	Cant.
18-3109	Tubo guía	23-29804	1
18-3017	Impulsor	47-89984	1
18-3116	Alojamiento	46-96148A1	1
18-3420	Base bomba agua	46-44292A3	1
18-2919	Junta base bomba agua	27-42631-1	1
18-3110	Casquillo	26-38970	1
18-2945	Junta tapón de vaciado	12-19183	2
18-2826	Junta base bomba agua	27-85610-1	1
18-2914	Junta inf. bomba a platina desgaste	27-85608-1	1
18-2915	Junta sup. bomba a platina desgaste	27-85609-1	1
18-2944	Retén	26-45577	1
18-3117	Platina	32435	1
18-7158	Aro tórico	25-30613	1
18-7162	Aro tórico	25-33145	1
18-7173	Aro tórico	25-30224	1
18-7176	Aro tórico	25-90011	1
18-2801	Junta bomba agua	27-32438	1
18-7196	Aro tórico	25-38099	1
18-7426	Aro tórico	35-30271	1



**18-3320
KIT BOMBA AGUA**

Para: unidades MR/Alpha I
S/N 6854393-OD469858

-- CONTIENE --

Ref #	Desc.	O.E. #	Cant.
18-3109	Tubo guía	23-29804	1
18-3017	Impulsor	47-89984	1
18-3116	Alojamiento	46-96148A1	1
18-3421	Base bomba agua	46-48748A1	1
18-2919	Junta base bomba de agua	27-42631-1	1
18-3110	Casquillo	26-38970	1
18-2945	Junta tapón de vaciado	12-19183	2
18-2826	Junta base bomba de agua	27-85610-1	1
18-2914	Junta inf. bomba a platina a desgaste	27-85608-1	1
18-2915	Junta sup. bomba a platina desgaste	27-85609-1	1
18-2944	Retén	26-45577	1
18-3117	Platina	32435	1
18-7158	Aro tórico	25-30613	1
18-7162	Aro tórico	25-33145	1
18-7173	Aro tórico	25-30224	1
18-7176	Aro tórico	25-90011	1
18-2801	Junta bomba agua	27-32438	1
18-7196	Aro tórico	25-38099	1
18-7426	Aro tórico	35-30271	1

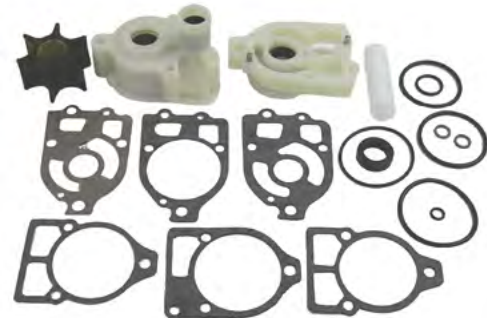

**18-3321
KIT BOMBA AGUA**

Para: #1 Units con enjuague
S/N 2495186-2763441

-- CONTIENE --

Ref #	Desc.	O.E. #	Cant.
18-3109	Tubo guía	23-29804	1
18-3017	Impulsor	47-89984	1
18-3116	alojamiento	46-96148A1	1
18-2919	Junta base bomba agua	27-42631-1	1
18-3417	Base bomba agua	46-57234A1	1
18-3110	Casquillo	26-38970	1
18-2945	Junta tapón de vaciado	12-19183	2
18-2826	(Junta) base bomba agua aloj. engranaje	27-85610-1	1
18-2914	Junta inf. bomba a platina	27-85608-1	1
18-2915	Junta sup. bomba a platina	27-85609-1	1
18-2944	Retén	26-45577	1
18-3117	Platina	32435	1
18-7158	Aro tórico	25-30613	1
18-7162	Aro tórico	25-33145	1
18-7173	Aro tórico	25-30224	1
18-7176	Aro tórico	25-90011	1
18-2801	Junta bomba agua	27-32438	1
18-7196	Aro tórico	25-38099	1
18-7426	Aro tórico	35-30271	1
18-2919	Junta bomba de agua	27-46231-1	1

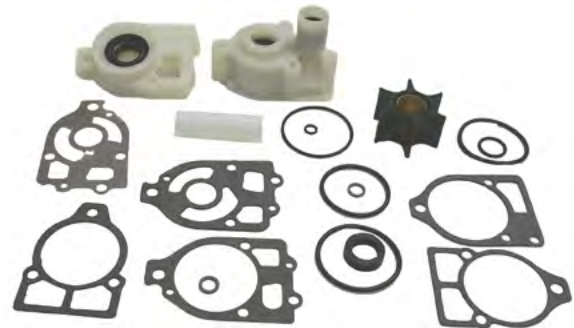

**18-3317
KIT BOMBA AGUA**

Para: #1/R Units sin enjuague
S/N 2763442-6854392

KIT BOMBA AGUA COMPLETA, KIT REPARACIÓN, APLICACIÓN IMPULSOR

Modelo	Serie Número	Kit bomba agua completo	Bomba alojamiento sup. Housing	Kit bomba superior	base bomba agua	Kit impulsor rep. (no alojamiento)	Impulsor
#1 con tornillo de plástico enjuague	2495186 - 2763441	18-3321	18-3116	18-3517	18-3421	18-3217	18-3017
#1 sin tornillo de plástico enjuague	2763442 - 6854392	18-3317 ①	18-3116	18-3517	18-3417 ①	18-3217	18-3017
MR/ALPHA I	6854393 - OD594568	18-3320	18-3116	18-3517	18-3420	18-3217	18-3017
ALPHA I - Generation II & Vazer	OD494569 & superior	18-3147	--	18-3570	--	18-3214	18-3056
BRAVO/Intraborda con cuerpo bomba plástico	3040411 & superior	--	--	18-3150	--	18-3318	18-3087
BRAVO/Intraborda con cuerpo bomba bronce	OM100001 & superior	--	--	18-3160	--	18-3016-1	--

① Modelos retrofijados con Alpha (sin pasador precarga) usar partes Alpha (18-3320 y 18-3420)

DESPIECE BOMBA AGUA II GENERACIÓN

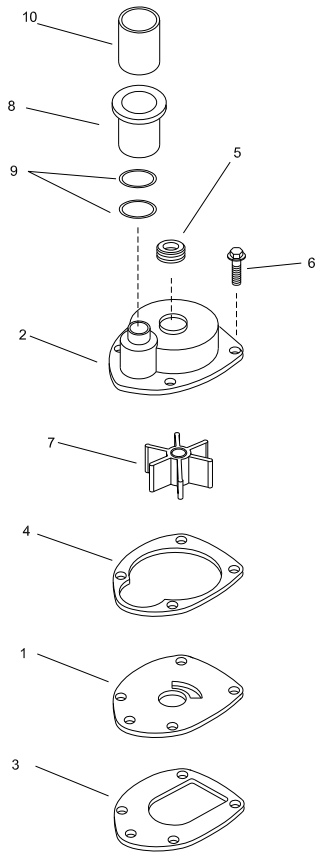

Sequence	Description	Part #	O.E. #	Qty.
1	Platina impulsor	18-3122	817276	1
2	Cuerpo bomba	N.S.S.	817275A1	1
3	Junta, Base	18-2564	27-43033-1	1
4	Junta, alojamiento	18-2566	27-817277	1
5	Retén	18-2599	26-816575A2	1
6	Tornillo	N/D	10-816928	4
7	Impulsor	18-3056	47-43026-2	1
8	Acoplamiento	18-3151	47-43026T11	1
9	Aro tórico	18-7420	25-21836	2
10	Manguito	18-3222	23-816583	1

DESPIECE BOMBA DE AGUA MR ALPHA

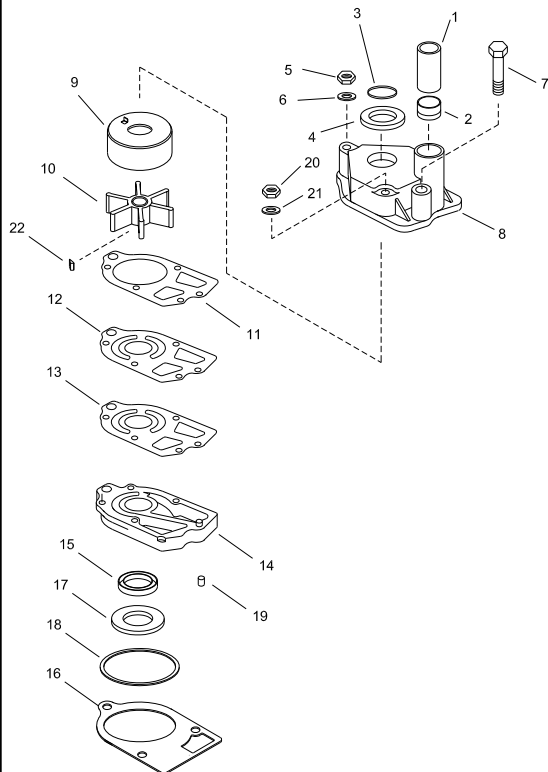





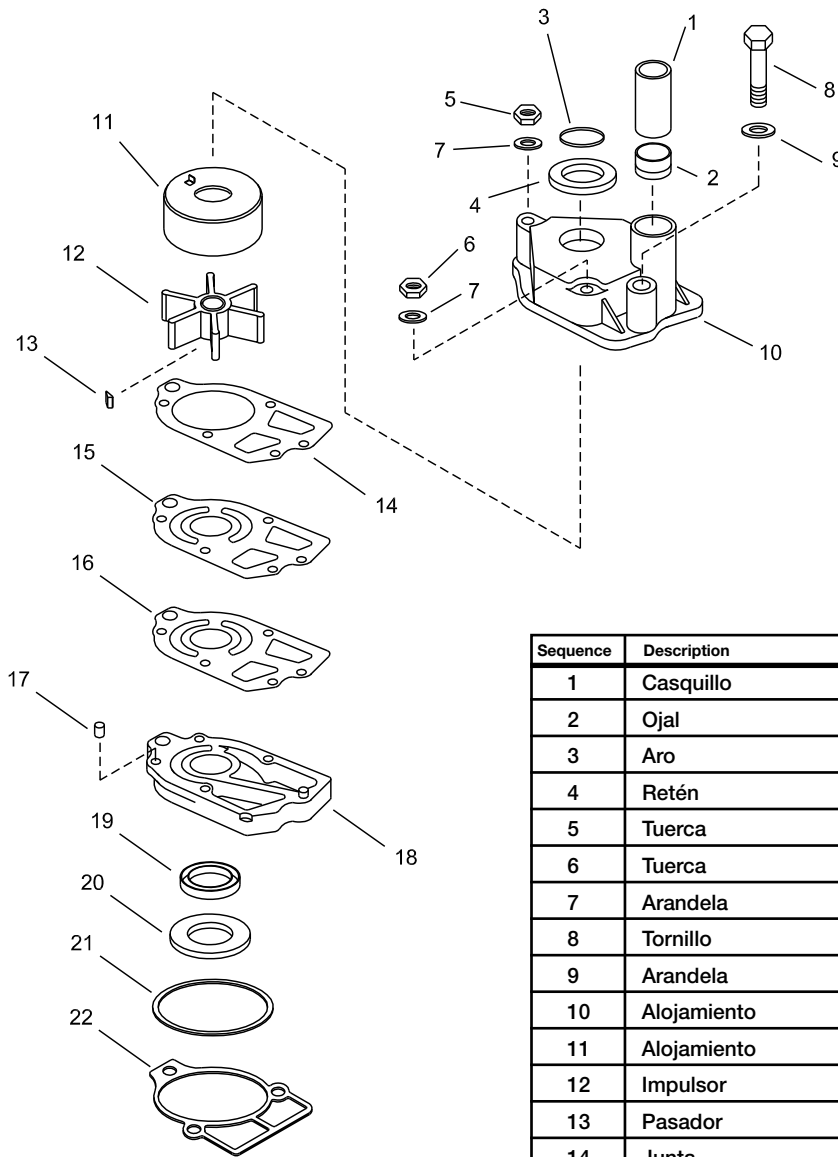

Sequence	Description	Part #	O.E. #	Qty.
1	Casquillo	18-3109	23-29804	1
2	Retén	18-3110	26-38970	1
3	Aro superior	18-7158	25-30613	1
4	Aro	18-7426	25-30271	1
5	Tuerca	N/A	11-13436	1
6	Arandela	18-4270	12-36001	3
7	Tornillo	N/A	10-96411	1
8	Alojamiento	18-3116	46-96148A1	1
9	Alojamiento	18-3114	48752T	1
10	Impulsor	18-3017	48752	1
11	Junta	18-2915	47-89984	1
12	Pletina	18-3117	27-85609-1	1
13	Junta	18-2914	27-85608-1	1
14	Base	18-3420	46-44292A3	1
15	Retén aceite	18-2013	26-16977	1
16	Junta	18-2919	27-42631-1	1
17	Retén aceite	18-2014	26-89238	1
18	Aro	18-7176	25-90011	1
19	Pasador	N/A	17-42836	1
20	Tuerca	N/A	11-13438	1
21	Arandela	18-4275	12-29245	2
22	Pasador	N/A	28-56654	1

DESPIECE BOMBA DE AGUA R/MR



Sequence	Description	Part #	O.E. #	Qty.
1	Casquillo	18-3109	23-29804	1
2	Ojal	18-3110	26-38970	1
3	Aro	18-7158	25-30613	1
4	Retén	18-7426	25-30271	1
5	Tuerca	18-3723	11-45592	1
6	Tuerca	18-3722	11-20361, 11-35888	2
7	Arandela	18-4275	12-29245	3
8	Tornillo	18-3226	10-30720	1
9	Arandela	18-4270	12-36001	1
10	Alojamiento	18-3116	46-96148A1	1
11	Alojamiento	18-3114	48752	1
12	Impulsor	18-3017	47-89984	1
13	Pasador	N/A	28-56654	1
14	Junta	18-2915	27-85609-1	1
15	Platina	18-3117	32435	1
16	Junta	18-2914	27-85608-1	1
17	Pasador	18-3227	17-35973	1
18	Base	18-3417	46-57234A1	1
19	Retén aceite	18-2013	26-16977	1
20	Retén aceite	18-2014	26-89238	1
21	Aro	18-7162	25-33145	1
22	Junta	18-2826	27-85610-1	1

 <p>18-3549 TERMOSTATO Reemplaza: 14586 120°</p>	 <p>18-3550 TERMOSTATO Reemplaza: 59078, 59078A1 140°</p>	 <p>18-3551 TERMOSTATO Reemplaza: 32728, 35884, 59137, 59137A1, 8072521, 8072531, 807252T1, 8M0089715 142°</p>	 <p>18-3552 TERMOSTATO Reemplaza: 76270, 76270T 160°</p>	 <p>18-3555 TERMOSTATO Reemplaza: 99155A1, 99155T2 160°</p>
------------------------------------------------------------------------------------------------------------------------------------------------------------	-------------------------------------------------------------------------------------------------------------------------------------------------------------------------	--------------------------------------------------------------------------------------------------------------------------------------------------------------------------------------------------------------------------------------	---------------------------------------------------------------------------------------------------------------------------------------------------------------------	-----------------------------------------------------------------------------------------------------------------------------------------------------------------------------

 <p>18-3557 TERMOSTATO Reemplaza: 47594 143°</p>	 <p>18-3649 TERMOSTATO Reemplaza: 8072522, 807252T2, 8052732, 8M0091470 160°</p>	 <p>18-43015 TERMOSTATO Reemplaza: Mercury 864493 Para: Mercuriuser MCM 4.3L MPI, 5.0L MPI y MX6.2L con escape seco y refrigeración cerrada.</p>	 <p>18-43017 TERMOSTATO Reemplaza: Mercury 863358T, 8M0074922 Para: Mercuriuser 496 Mag & HO, 8.1L MIE & HO</p>	 <p>18-3568 KIT TERMOSTATO Reemplaza : 99155T1</p> <table border="1"> <thead> <tr> <th>Modelo</th> <th>Año</th> <th>Serie #</th> </tr> </thead> <tbody> <tr> <td>5.7MIE</td> <td>1998-2001</td> <td>OL002003 & Sup</td> </tr> <tr> <td>MX6.2LMPI</td> <td>2000-2001</td> <td>OL680003 & Sup</td> </tr> <tr> <td>454 Horizon MIE</td> <td>1998-2001</td> <td>OL002200 & Sup</td> </tr> <tr> <td>502 Mag. MPI</td> <td>1998-2001</td> <td>OL017000 & Sup</td> </tr> </tbody> </table>	Modelo	Año	Serie #	5.7MIE	1998-2001	OL002003 & Sup	MX6.2LMPI	2000-2001	OL680003 & Sup	454 Horizon MIE	1998-2001	OL002200 & Sup	502 Mag. MPI	1998-2001	OL017000 & Sup
Modelo	Año	Serie #																	
5.7MIE	1998-2001	OL002003 & Sup																	
MX6.2LMPI	2000-2001	OL680003 & Sup																	
454 Horizon MIE	1998-2001	OL002200 & Sup																	
502 Mag. MPI	1998-2001	OL017000 & Sup																	



18-3644
KIT TERMOSTATO
-CONTIENE-

Ref #	Descripción	O.E.#
18-3649	Termostato 160°	807252T2
18-2553	Termostato Junta tapa	27-47510
18-2917	Termostato Junta tapa	27-53045-1



18-3646
KIT TERMOSTATO
Reemplaza: 807252Q3, 807252T6
-CONTIENE-

Ref #	Descripción	O.E.#
18-3551	Termostato	59137
18-2917	Junta Termostato alojamiento	27-53045-1, 27-33918
18-2844	Junta tapa termostato	27-48818-1
18-2553	Junta tapa termostato	27-47510
18-2834	Junta tapa termostato	27-60208



18-3647
KIT TERMOSTATO
Reemplaza: 807252Q5, 807252T8
-CONTIENE-

Ref #	Descripción	O.E.#
18-3649	Termostato	807252-2
18-2844	Junta tapa termostato	27-48818-1
18-2552	Junta tapa termostato	27-33179-2
18-2553	Junta tapa termostato	27-47510
18-7173	Aro tórico	25-30224
18-2917	Junta tapa termostato	27-53045-1, 27-33918



18-3648
KIT TERMOSTATO
160°



18-3650
KIT TERMOSTATO
-CONTIENE-

Ref #	Descripción	O.E.#
18-2831	Junta termostato	27-47590-1
18-3550	Termostato	59078



18-3651
KIT TERMOSTATO
-CONTIENE-

Ref #	Descripción	O.E.#
18-2554	Junta tapa termostato	27-90556
18-2553	Junta tapa termostato	27-47510
18-2834	Junta tapa termostato	27-60208
18-2844	Junta tapa termostato	27-48818-1
18-3551	Termostato	59137



18-3652
KIT TERMOSTATO
-CONTIENE-

Ref #	Descripción	O.E.#
18-2555	Junta tapa termostato	27-89656-1
18-2843	Junta tapa termostato	27-74830
18-3552	Termostato	76270



18-3667
KIT TERMOSTATO
-CONTIENE-

Ref #	Descripción	O.E.#
18-2555	Junta tapa termostato	27-89656-1
18-3555	Termostato	99155A1



18-3668
KIT TERMOSTATO
Reemplaza: 807252T4, 807252Q4
-CONTIENE-

Ref #	Descripción	O.E.#
18-2552	Junta tapa termostato	27-33179-2
18-2553	Junta tapa termostato	27-47510
18-2554	Junta tapa termostato	27-41812
18-3551	Termostato	59137
18-7173	Aro tórico	25-30224
18-2917	Junta alojamiento termostato	27-53045-1, 27-33918

APLICACIONES TERMOSTATOS EMPIEZAN EN LA SIGUIENTE PÁGINA

① Referencias acabadas en D envasadas - Referencias sin D no envasadas



18-1977-1
TERMOSTATO ALOJAMIENTO
Reemplaza: 47441, 47441A1
Para 225, GM 260, 228, 898/198,
185R, 898R, 228R, 2GR



18-1989
TERMOSTATO ALOJAMIENTO
Reemplaza: 87290A4, 861006A1
Acero inox
Use 18-1989K Kit servicio termostato
para piezas de repuesto



18-1993
TERMOSTATO ALOJAMIENTO
Reemplaza: 47587, 47587A2, 47588,
60372A1, 60372A2, 60908A2, 861493A3,
861493A07



18-1994
TERMOSTATO ALOJAMIENTO
Reemplaza: 8M0061381
Para: Acero inox Version use 18-1989



18-3531
TERMOSTATO ALOJAMIENTO
Reemplaza: 861188A1, 807074A1,
808064A1
Para: MCM/MIE GM V-6 & V-8 305,350,454 & 502 cid
motores con sistemas de refrigeración cerrado



18-1910
KIT TERMOSTATO ALOJAMIENTO
Reemplaza: 47587, 47587A2, 47588,
60372A1, 60372A2, 63908A2, 861493A07,
861493A3
Para: 3.0L GM 1999-Sup, S/N 0L340999-inf



18-1989K
KIT SERVICIO TERMOSTATO
Kit servicio para 18-1989 alojamiento termostato



18-1508
RETÉN TERMOSTATO
Reemplaza: 25-8071341
Para: Vazer (2007 & SUP), GM
V6 & V8 con cierre del sistema
de alojamiento (1996 & SUP)

APLICACIÓN TERMOSTATO

Motores / Modelo	CID / # Cil	Intervalo Año	Desde Nº Serie #	Hasta Nº serie #	Alojamiento	Tapa termostato	Termostato & Kit juntas	Termostato	Requiere juntas	Requiere Juntas - Design II	Requiere Juntas - Diseño III
ROVER			3140000	SUP	—			18-3551	—		
60	68/L4	1965-1968	1887079	2049044				18-3551			
80	80/L4	1966-1969	2049045	2851423				18-3551			
90	96/L4	1970-1972	2851424	3226957				18-3557	18-2831		
100 VASER	98/L4	2007-2010	w995000	& SUP					18-1508		
110	153/L4	1963-1966	1537370	2044033		①		18-3551			
110	153/L4	1963-1966	1821720	2044033		②		18-3551			
120	153/L4	1964-1972	1666601	3377340		③		18-3551			
120	153/L4	1964-1966	1725593	2046624		④		18-3551			
120	153/L4	1967	2046625	2324346		⑤		18-3551			
120	153/L4	1968-1972	2324347	3377340	18-3650	⑥, ③	18-3650	18-3550	18-2831		
120	153/L4	1972-1986	3377341	B531853	18-3650	③	18-3650	18-3550	18-2831		
2.5L	153/L4	1987-1989	B531854	C853255	18-3650	③	18-3650	18-3550	18-2831		
140	181/L4	1968-1986	2508261	B450800	18-3650	③	18-3650	18-3550	18-2831		
140 (6 CIL)			1538930	1725960				18-3551			
3.0L	181/L4	1987-1989	B450801	C856558	18-3650	③	18-3650	18-3550	18-2831		
3.0L, FWC	181/L4	1990-2010	C856559	SUP		④	18-3647	18-3649			
3.0L	181/L4	1990-1994	C856559	F603999	18-3650	⑦, ③	18-3650	18-3550	18-2831		
3.0L	181/L4	2000-2010	L341000	& UP		⑦	18-3647	18-3649	18-2552		
3.0L	181/L4	1998-2000	L010042	L340999	18-3650	⑦, ③	18-3650	18-3550	18-2831		
3.0L MPI	181/L4	2008-2010	A072812	& SUP			18-3647	18-3649	18-2552		
3.0L MPI FWC	181/L4	2008-2010	A072812	& SUP		⑧	18-3647	18-3649			
3.0LX, FWC	181/L4	1990-1997	C856559	K999999		⑧	18-3647	18-3649			
3.0LX	181/L4	1990-1997	C856559	K999999	18-1910	⑦, ③	18-3650	18-3550	18-2831		
150			1666495	2048046				18-3551			
160			2048022	2770031				18-3551			
160			2048022	2233574				18-3557			
160			2326069	2770031				18-3557	18-2831		
165			2770032	5813433			18-3650	18-3550	18-2831		
165	224/L4	1987	B434941	B774251			18-3667	18-3555	18-2555		
165			6916779	SUP			18-3667	18-3555	18-2555		

- ① Diseño I
- ② Diseño II
- ③ Diseño III
- ④ Aluminio escape Manifold
- ⑤ Colector escape Manifold
- ⑥ Refrigeración cerrado
- ⑦ Refrigeración estándar
- ⑧ Con bola retención
- ⑨ Sin bola retención

- ⑩ SN 4167000 & Sup
- ⑪ Termostato aloj. Original aparece como la NLA.
Kit actualización 87290A23
- ⑫ Termostato aloj. original aparece como la NLA.
Kit actualización 90736A24
- ⑬ Termostato alojamiento kit completo
- ⑭ Solo 3 puntos y sistema de drenaje
- ⑮ Sistema de drenaje 7 puntos
- ⑯ Cuerpo acelerador mecánico

- ⑰ Cuerpo acelerador digital
- ⑱ Motor control de emisiones
- ⑲ Sistema drenaje manual
- ⑳ Sistema drenaje aire actuado
- ㉑ Diseño antiguo
- ㉒ Diseño nuevo
- ㉓ 160 grados
- ㉔ Para acero inoxidable use versión 18-1989

APLICACIÓN TERMOSTATO (Cont.)

Motor / Modelo	CID / # CIL	Intervalo años	Desde Nº Serie #	Hasta Nº Serie #	Alojamiento	Termostato Tapa	Termostato & kit juntas	Termostato	Requiere Juntas	Requiere juntas - Diseño II	Juntas Requiere - Desieño I
170	224/L4	1985-1986	6916779	B434940	18-3667		18-3667	18-3555	18-2555		
175/4.3L, 4.3LX (262 CID)	③		B527955	SUP	—		18-3668	18-3551	18-2553	18-2554	
175/4.3L, 4.3 LX (262 CID)	④		B527955	SUP	—		18-3668	18-3551	18-2552	18-2553	
175/4.3L, 4.3 LX (262 CID)	④		F001220	SUP	—		18-3648	18-3649	18-2552	18-2553	
180/3.7L-LX (4 CIL)			6916779	SUP	—		18-3667	18-3555	18-2555		
180	224/L4	1987	B436391	B775248			18-3667	18-3555	18-2555		
185 (229 CID)			6330183	6919655	18-1994	♥	18-3668	18-3551	18-2553	18-2554	
185 (262 CID)			A331455	B527954	18-1994	♥	18-3668	18-3551	18-2553	18-2554	
190			1564539	1730903	—			18-3551	—		
190	224/L4	1985-1986	6916779	B436390			18-3667	18-3555	18-2555		
3.7L	224/L4	1988-1989	B774552	& SUP			18-3667	18-3555	18-2555		
3.7LX	224/L4	1988-1989	B775249	& SUP			18-3667	18-3555	18-2555		
470 MCM/MIE	224/L4	1976-1982	4208730	6218036				18-3552	18-2843		
470	224/L4	1983-1984	6218037	6916778			18-3667	18-3555	18-2555		
485	224/L4	1980-1982	5685394	6218036				18-3552	18-2555		
488	224/L4	1983-1984	6170297	6916778			18-3667	18-3555	18-2555		
140 (6 CIL)	194/L6	1963	1538930	1725960				18-3551			
150	230/L6	1964-1966	1666495	2048046		①		18-3551			
150	230/L6	1964-1966	1727985	2048046		②		18-3551			
160	250/L6	1967-1969	2048022	2770031		③		18-3551			
160	250/L6	1967	2048022	2233574		④		18-3551			
160	250/L6	1968-1969	2326096	2770031	18-1910	⑤ ⑥		18-3557	18-2831		
165 (6 CIL)	250/L6	1970-1981	2770032	5813433	18-1910	⑦	18-3650	18-3550	18-2831		
200 (6 CIL)	292/L6	1969	2453769	2712072	18-1910	⑧		18-3557	18-2831		
185 (4bb)	229-V-6	1983-1984	6330183	6919655	18-3678		18-3668	18-3551	18-2554	18-2553	18-2917
175	262/V-6	1987	B527955	B773242	18-1994	⑨	18-1977-1	18-3668	18-3551	18-2554	18-2917
175	262/V-6	1987	B527955	B773242		⑩ ⑪		18-3668	18-3551	18-2554	18-2917
185 (2bb)	262/V-6	1985-1986	A331455	B527954	18-1994		18-1977-1	18-3668	18-3551	18-2554	18-2917
205	262/V-6	1985-1986	A331455	B527954	18-3668		18-1977-1	18-3668	18-3551	18-2554	18-2917
205	262/V-6	1987	B527955	B775129	18-3668	⑫	18-1977-1	18-3668	18-3551	18-2554	18-2917
205	262/V-6	1967	B527955	B775129		⑬ ⑭		18-3668	18-3551	18-2552	18-2917
205/4.3L, 4.3 LX (262 CID)	④		B527955	D714369	—	⑮		18-3668	18-3551	18-2552	18-2917
205/4.3L, 4.3 LX (262 CID)	④		F001220	SUP	—		18-3648	18-3649	18-2552	18-2553	
215 FORD			2781153	3040410	—			18-3551	—		
215 FORD			3040411	SUP	—		18-3651	18-3551	18-2834	—	
215 FORD MCM/MIE			3040411	3385720	—		18-3646	18-3649	18-2834	—	
225 FORD MCM/MIE			3385721	4176999	—		18-3646	18-3649	18-2834	—	
262 MAG EFI ALPHA	262/V-6	1996-1997	0F803800	0K999999	18-3647		18-3647	18-3649	18-2917		
262 MAG EFI BRAVO	262/V-6	1996-1997	0F803800	0K999999	18-3647		18-3647	18-3649	18-2917		
4.3L	262/V-6	1988-1993	B773243	F000877	18-1994	⑯	18-1977-1	18-3668	18-3551	18-2554	18-2917
4.3L	262/V-6	1987-1993	B773243	F000877		⑰ ⑱		18-3668	18-3551	18-2552	18-2917
4.3L	262/V-6	1993-1995	F000878	F601126	18-3647	⑲ ⑳		18-3668	18-3649	18-2917	18-2917
4.3L	262/V-6	1993-1995	F000878	F601126		㉑		18-3668	18-3551	18-0398	
4.3L FWC	262/V-6	1993-2002	F000878	M614999	18-3531	㉒		18-3568	18-3555	18-0398	
4.3L ALPHA	262/V-6	1996-2002	0F601127	M614999	18-3647	㉓		18-3647	18-3649	18-2917	
4.3L BRAVO	262/V-6	2996-2002	0F601127	M614999	18-3647	㉔		18-3647	18-3649	18-2917	
4.3L FWC	262/V-6	2002-2010	M615000	& SUP		㉕			18-0398		
4.3L	262/V-6	2002-2010	M615000	& SUP		㉖	18-3647	18-3649	18-0398		
4.3L EFI FWC	262/V-6	1998-2001	L012009	M299999	18-3531	㉗		18-3568	18-3555	18-0398	
4.3L EFI ALPHA	262/V-6	1998-2001	L012009	M299999		㉘		18-3647	18-3649	18-0398	
4.3L EFI BRAVO	262/V-6	1998-2001	L012009	M299999	18-3530-1	㉙		18-3647	18-3649	18-0398	
4.3L MPI	262/V-6	2002-2010	M300000	& SUP		㉚ ㉛		18-3647	18-3649	18-0398	
4.3L MPI	262/V-6	2002-2010	M300000	& SUP		㉜ ㉝		18-3647	18-3649	18-0398	
4.3L MPI EC	262/V-6	2010-2011	A637496	& SUP		㉞ ㉟		18-3647	18-3649	18-0398	
4.3L MPI FWC	262/V-6	2002	M300000	M614999		㊱		18-3568	18-3555	18-0398	
4.3L MPI FWC	262/V-6	2002-2010	M615000	& SUP		㊲			18-0398		
4.3LH FWC	262/V-6	1998-2002	L010044	M614999	18-3531	㊳		18-3568	18-3555	18-0398	
4.3LH ALPHA	262/V-6	1998-2002	L010044	M614999		㊴		18-3647	18-3649	18-0398	
4.3LH BRAVO	262/V-6	1998-2002	L010044	M614999	18-3530-1	㊵		18-3647	18-3649	18-0398	
4.3LX	262/V-6	1988-1993	B775130	F001219	18-1994	㊶	18-1977-1	18-3668	18-3551	18-2554	18-2917
4.3LX	262/V-6	1988-1993	B775130	F001219		㊷ ㊸		18-3668	18-3551	18-2552	18-2917
4.3LX	262/V-6	1993-1995	F001220	F601126		㊹ ㊺		18-3668	18-3551	18-2552	18-2917
43.LX	262/V-6	1993-1995	F001220	F601126		㊻ ㊼		18-3668	18-3551	18-0398	
4.3LX FWC	262/V-6	1993-1997	F001220	K999999		㊽		18-3567	18-3555	18-0398	
4.3LX ALPHA	262/V-6	1996-1997	F601127	K999999		㊾		18-3647	18-3649	18-0398	
4.3LX BRAVO	262/V-6	1996-1997	F601127	K999999	18-3530-1	㊿		18-3647	18-3649	18-0398	
4.3LXH FWC	262/V-6	1996-1997	F803114	K999999	18-3531	㉀		18-3568	18-3555	18-0398	
4.3LXH ALPHA	262/V-6	1996-1997	F803114	K999999	18-3530-1	㉁		18-3647	18-3649	18-0398	
4.3LXH BRAVO	262/V-6	1996-1997	F803114	K999999	18-3530-1	㉂		18-3647	18-3649	18-0398	
215 MCM/MIE (FORD)	302/V-8	1970	2781153	3040410				18-3646	18-3551	18-2834	
215 MCM/MIE (FORD)	302/V-8	1971-1972	3040411	3385720				18-3646	18-3551	18-2834	
225 MCM/MIE (FORD)	302/V-8	1973-1974	3385721	4176999				18-3646	18-3551	18-2834	
888 (FORD)	302/V-8	1971-1977	3108723	4887829		㉃		18-3646	18-3551	18-2834	
190	283/V-8	1963-1964	1564539	1730903				18-3551			
198 MIE	305/V-8	1977	4776402	4931099			18-1977-1	18-3646	18-3551	18-2844	18-0398
200	305/V-8	1985-1987	6899058	B774444	18-1994		18-1977-1	18-3668	18-3551	18-2554	18-2553
200 GM			6218462	B525981	18-1994	♥		18-3668	18-3551	18-2553	18-2554
200/5.0L			0B525982	0F600999				18-3647	18-3649	18-2917	
200/5.0L GM	③		B525982	SUP	18-1994	♥		18-3668	18-3551	18-2553	18-2554
200/5.0L GM	④		B525982	SUP	18-1994	♥		18-3648	18-3649	18-2552	18-2917
228	305/V-8	1977-1982	4765100	6218461			18-1977-1	18-3646	18-3551	18-2844	18-0398
228	305/V-8	1982-1984	6218462	6899268	18-1994		18-1977-1	18-3668	18-3551	18-2554	18-2553
228 MIE	305/V-8	1977-1980	4765100	5907057	18-3651		18-1977-1	18-3646	18-3551	18-2844	18-1993
230	305/V-8	1985-1987	6899269	B773739	18-1994		18-1977-1	18-3668	18-3551	18-2554	18-2553
230 MIE	305/V-8	1981-1987	5907058	B788151	18-1994	①	18-1977-1	18-3668	18-3551	18-2554	18-2553
230 MIE FWC	305/V-8	1981-1987	5907058	B788151		②	18-1977-1	18-3646	18-3551	18-2553	18-2844
230 GM			6218462	B525981	18-1994	♥		18-3668	18-3551	18-2553	18-2554
230 MIE			5907058	0B5225505				18-3646	18-3649	18-2553	18-2844
230 GM IB	⑤		5907058	B522505		③		18-3668	18-3551	18-2553	18-2554
230 GM IB	⑥		5907058	B522505		④		18-3651	18-3551	18-2553	18-2844
230/5.0L GM IB	③ ⑤		B522506	B525981		⑤ ⑥		18-3668	18-3551	18-2553	

APLICACION TERMOSTATO (Cont.)

Motor / Modelo	CID / # CIL	Intervalo Año	Desde Nº serie #	Hasta Nº Serie #	Alojamiento	Termostato Tapa	Termostato & kit juntas	Termostato	Requiere Juntas	Juntas Requiere - Diseño II	Junta Requiere - Diseño II
5.0L	305/V-8	1988-1995	B774445	F600999	② ⑤		18-3668	18-3551	18-7173	18-2552	
5.0L	305/V-8	1988-1995	B774445	F600999	③		18-3647	18-3649	18-0398		18-2917
5.0L (GEN +) FWC	305/V-8	1998-2002	L015751	M599999	18-3531	③	18-3568	18-3555	18-1508		18-2917
5.0L (GEN +) FWC	305/V-8	2002-2010	M600000	& SUP		③			18-0398		18-2917
5.0L (GEN +) ALPHA	305/V-8	1998-2002	L015751	M599999		⑦	18-3647	18-3649	18-0398		
5.0L (GEN +) BRAVO	305/V-8	1998-2002	L015751	M599999	18-3530-1	⑦	18-3647	18-3649	18-0398		
5.0L (GEN +)	305/V-8	2002-2010	M600000	& SUP		⑦	18-3647	18-3649	18-0398		
5.0L EFI FWC	305/V-8	1998-2001	L012052	M299999	18-3531	⑦	18-3568	18-3555	18-1508		
5.0L EFI ALPHA	305/V-8	1998-2001	L012052	M299999		⑦	18-3647	18-3649	18-0398		
5.0L EFI BRAVO	305/V-8	1998-2001	L012052	M299999	18-3530-1	⑦	18-3647	18-3649	18-0398		
5.0L MIE FWC	305/V-8	1988	B788152	C396832		③	18-1977-1	18-3646	18-3551	18-2553	18-2844
5.0L MIE	305/V-8	1988	B788152	C396832		② ③ ④		18-3668	18-3551	18-7173	
5.0L MIE	305/V-8	1988	B788152	C396832	18-1994	① ⑦	18-1977-1	18-3668	18-3551	18-2554	18-2553
5.0L MPI FWC	305/V-8	2002	M300000	M599999		③	18-3568	18-3555	18-0398		
5.0L MPI FWC	305/V-8	2002-2010	M600000	& SUP		③			18-0398		18-2917
5.0L MPI FWC DTS	305/V-8	2005-2010	W310000	& SUP		③ ⑦			18-0398		18-2917
5.0L MPI FWC EC	305/V-8	2008-2010	A300000	& SUP		③ ⑥ ⑧			18-0398		
5.0L MPI FWC EC DTS	305/V-8	2008-2010	A300000	& SUP		③ ⑦ ⑧			18-0398		
5.0L MPI	305/V-8	2002-2010	M300000	& SUP		⑦ ④	18-3647	18-3649	18-0398		18-2917
5.0L MPI ALPHA	305/V-8	2002	M300000	M599999		⑦ ⑤	18-3647	18-3649	18-0398		
5.0L MPI BRAVO	305/V-8	2002	M300000	M599999	18-3530-1	⑦ ⑤	18-3647	18-3649	18-0398		
5.0L MPI	305/V-8	2002-2010	M600000	& SUP		⑦ ⑤	18-3647	18-3649	18-0398		
5.0L MPI EC	305/V-8	2008-2010	A300000	& SUP		⑦ ⑧	18-3647	18-3649	18-0398		
5.0L LX	305/V-8	1988-1995	B773740	F600999	18-1994	①	18-1977-1	18-3668	18-3551	18-2554	18-2553
5.0LX	305/V-8	1988-1995	B773740	F600999		② ⑤		18-3668	18-3551	18-7173	18-2552
5.0LX	305/V-8	1988-1995	B773740	F600999		③	18-3647	18-3649	18-0398		
898	305/V-8	1977-1982	4762210	6218461			18-1977-1	18-3646	18-3551	18-2844	18-0398
898	305/V-8	1983-1984	6218462	6899057	18-1994		18-1977-1	18-3668	18-3551	18-2554	18-2553
225 (GM)	327/V-8	1967-1969	2399198	2694014			18-1977-1	18-3651	18-3551	18-2553	18-2844
225 (GM)	327/V-8	1963-1967	1539620	2399197	N.L.A.				18-3551		
225 (GM)			2278647	2399197				18-3668	18-3551	18-2552	18-7173
225/2255 FORD			3385721	SUP				18-3651	18-3551	18-2834	
250 MCM/MIE	327/V-8	1968-1969	2314301	2639854			18-1977-1	18-3651	18-3551	18-2553	18-2844
250	350/V-8	1977	4768000	4908849	18-1993		18-1977-1	18-3651	18-3551	18-2844	
250 (GM)			4768000	4908849				18-3646	18-3551	18-2844	
250 (GM)			4175500	5907057	18-1993			18-3651	18-3649	18-2844	18-2917
255 (GM)	350/V-8	1975-1976	4175500	4767999			18-1977-1	18-3646	18-3551	18-2844	18-0398
255 (GM) MIE	350/V-8	1975-1980	4175500	5907057			18-1977-1	18-3646	18-3551	18-2844	18-0398
255 FORD			3258728	SUP				18-3651	18-3551	18-2834	
255 FORD MCM/MIE			3258728	4178299				18-3646	18-3649	18-2834	
260	350/V-8	1978-1982	4908850	6218461			18-1977-1	18-3651	18-3551	18-2844	18-0398
260	350/V-8	1982-1987	6218462	6218462	18-1994		18-1977-1	18-3668	18-3551	18-2554	18-2553
260 MIE FWC	350/V-8	1981-1987	5907058	788151		③		18-3646	18-3551	18-2553	18-2844
260 MIE	350/V-8	1981-1987	5907058	788151	18-1994	⑦	18-1977-1	18-3668	18-3551	18-2554	18-2553
260 GM			6218462	8525981	18-1994	⑦		18-3668	18-3551	18-2553	18-2554
260 GM			4908850	6218461				18-3646	18-3649	18-2844	18-2917
260 GM IB	⑤		5907058	8522505		⑦		18-3668	18-3551	18-2553	18-2554
260 GM IB	⑥		5907058	8522505		③		18-3651	18-3551	18-2553	18-2844
260 MIE			5907058	08522505				18-3646	18-3649	18-2553	18-2844
260/5.7L GM IB	③ ⑤		8522506	8525981		⑦		18-3668	18-3551	18-2553	18-2554
260/5.7L GM IB	④ ⑤		8522506	8525981		⑦		18-3668	18-3551	18-2552	18-7173
260/5.7L GM IB	④ ⑤		8522506	8525981		⑦		18-3648	18-3649	18-2552	18-7173
260/5.7L GM IB	⑥		8522506	8525981		③		18-3651	18-3551	18-2553	18-2844
260/5.7L GM	③		8525982	F600999	18-1994	⑦		18-3668	18-3551	18-2553	18-2554
260/5.7L GM	④		8525982	F600999				18-3668	18-3551	18-2552	18-7173
260/5.7L GM	④		8525982	F600999				18-3648	18-3649	18-2552	18-7173
260/5.7L GM			08525982	0F000999				18-3647	18-3649	18-2917	
260/5.7L MIE			08522506	0F024999				18-3646	18-3649	18-2553	18-2844
270 MCM/MIE	350/V-8	1969-1972	2851074	3385720			18-1977-1	18-3646	18-3551	18-2553	18-2844
270 GM			2851074	3077735				18-3651	18-3551	18-2553	18-2844
280 GM	350/V-8	1975-1976	4176250	4770199			18-1977-1	18-3646	18-3649	18-2844	18-0398
280 GM TRS			4176250	4770199	18-1993			18-3651	18-3551	18-2844	
300	350/V-8	1985-1986	6668677	B430367			18-1977-1	18-3668	18-3551	18-2554	18-2553
320 EFI	350/V-8	1987-1989	A543604	C622418			18-1977-1	18-3646	18-3551	18-2553	18-2844
325 GM MCM/MIE			2278747	3780449				18-3646	18-3649	18-2553	18-2844
325 GM			2278747	2313964				18-3668	18-3551	18-2553	
325 GM			2313965	3042730				18-3651	18-3551	18-2553	18-2844
325 GM			3042731	SUP				18-3651	18-3551	18-2844	
330 GM			4623115	SUP				18-3651	18-3551	18-2844	
330 GM MCM/MIE			4623115	0B816540				18-3646	18-3649	18-2553	18-2844
330 GM W/BW	⑤		6083145	SUP		⑦		18-3668	18-3551	18-2553	18-2554
330 GM W/BW	⑥		6083145	SUP		⑦		18-3651	18-3551	18-2553	18-2844
350 MAG ALPHA	350/V-8	1987-1995	B525982	F600999		② ⑤		18-3668	18-3551	18-7173	18-2917
350 MAG ALPHA	350/V-8	1986-1995	A635178	B525981		①	18-1977-1	18-3668	18-3551	18-2554	18-2553
350 MAG ALPHA	350/V-8	1987-1995	B525982	F600999		② ⑤		18-3668	18-3551	18-7173	18-2552
350 MAG ALPHA	350/V-8	1987-1997	B525982	K999999		③		18-3647	18-3649	18-0398	
350 MAG ALPHA EFI (GEN +)	350/V-8	1996-1997	F800300	K999999		③		18-3647	18-3649	18-0398	
350 MAG BRAVO MPI	350/V-8	1995-1997	F415189	K999999	18-3530-1			18-3647	18-3649	18-0398	
350 MAG EFI SKI	350/V-8	1994-1997	F215561	K999999	18-3530-1			18-3647	18-3649	18-0398	
350 MAG MPI FWC	350/V-8	1998-2001	L010019	M299999	18-3531	③		18-3568	18-3555	18-1508	
350 MAG MPI	350/V-8	1998-2001	L010019	M299999	18-3530-1	⑦		18-3647	18-3649	18-0398	
350 MAG MPI FWC	350/V-8	2002	M300000	M599999		③		18-3568	18-3555	18-0398	
350 MAG MPI FWC	350/V-8	2002-2010	M600000	& SUP		③			18-0398		
350 MAG MPI FWC DTS	350/V-8	2005-2010	W310000	& SUP		③ ⑦			18-0398		
350 MAG MPI FWC EC	350/V-8	2008-2010	A300000	& SUP		③ ⑥ ⑧			18-0398		
350 MAG MPI FWC EC DTS	350/V-8	2008-2010	A300000	& SUP		③ ⑦ ⑧		N/A	18-0398		
350 MAG MPI	350/V-8	2002	M300000	M599999		⑦ ④	18-3647	18-3649	18-0398		
350 MAG MPI ALPHA	350/V-8	2002	M300000	M599999		⑦ ⑤	18-3647	18-3649	18-0398		
350 MAG MPI BRAVO	350/V-8	2002	M300000	M599999	18-3530-1	⑦ ⑤	18-3647	18-3649	18-0398		
350 MAG MPI	350/V-8	2002-2010	M600000	& SUP		⑦ ⑤	18-3647	18-3649	18-0398		
350 MAG MPI	350/V-8	2002-2010	M600000	& SUP		⑦ ④	18-3647	18-3649	18-0398		
350 MAG MPI EC	350/V-8	2008-2010	A300000	& SUP		⑦ ⑧	18-3647	18-3649	18-0398		
350 MAG MPI HORIZON	350/V-8	2002	M300000	M599999		③		18-3568	18-3555	18-0398	
350 MAG MPI HORIZON	350/V-8	2002-2007	M600000	A299999		③			18-0398		
350 MAG MPI HORIZON MIE	350/V-8	1999-2001	L304700	M299999	18-3531	③		18-3568	18-3555	18-1508	
350 MAG MPI HORIZON MIE	350/V-8	2002	M300000	M316999		③		18-3568	18-3555	18-1508	
350 MAG MPI HORIZON MIE	350/V-8	2002-2007	M317000	A089999		③			18-0398		
350 MAG MPI MIE FWC	350/V-8	1998-2001	L002008	M299999	18-3531	③		18-3568	18-3555	18-1508	
350 MPI MIE	350/V-8	1998-2001	L002008	M299999	18-3530-1	⑦		18-3647	18-3649	18-0398	
350 MAG MPI MIE FWC	350/V-8	2002	M300000	M316999		③		18-3568	18-3555	18-1508	
350 MAG MPI MIE FWC	350/V-8	2002-2007	M317000	A089999		③			18-0398		

- ① Diseño I
- ② Diseño II
- ③ Diseño III
- ④ Aluminio escape Manifold
- ⑤ Colector escape Manifold
- ⑥ Refrigeración cerrado
- ⑦ Refrigeración estándar
- ⑧ Con bola retención
- ⑨ Sin bola retención

APLICACIÓN TERMOSTATO (Cont.)

Motor / Modelo	CID / # CIL	Intervalo años	Desde N° serie #	Hasta N° serie #	Alojamiento	Tapa Termostato	Termostato & kit junta	Termostato	Requiere junta	Junta Requiere- Diseño II	Junta Requiere - Diseño III
350 MAG MPI MIE	350/V-8	2002-2007	M300000	A089999				18-3647	18-3649	18-0398	
350 MAG MPI SKI	350/V-8	1995-2001	F350583	M299999	18-3530-1			18-3647	18-3649	18-0398	
350 MAG MPI SKI	350/V-8	2002-2007	M300000	A089999				18-3647	18-3649	18-0398	
350 MAG SKI	350/V-8	1991-1996	D505450	K040399				18-3668	18-3551	18-1713	18-2552
350 MAG SKI	350/V-8	1991-1997	D505450	K999999	18-3530-1			18-3647	18-3649	18-0398	18-2917
5.7L	350/V-8	1988-1995	B773305	F600999	18-1994		18-1977-1	18-3668	18-3551	18-2554	18-2553
5.7L	350/V-8	1988-1995	B773305	F600999				18-3668	18-3551	18-1713	18-2552
5.7L	350/V-8	1988-1995	B773305	F600999				18-3668	18-3551	18-2552	18-2917
5.7L	350/V-8	1988-1996	B773305	K001526				18-3647	18-3649	18-1713	18-2552
5.7L FWC	350/V-8	1997	K001526	K999999	18-3531			18-3568	18-3555	18-2844	18-0398
5.7L ALPHA	350/V-8	1988-1997	B773305	F600999				18-3647	18-3649	18-1508	
5.7L BRAVO	350/V-8	1995-1997	F601000	K999999	18-3530-1			18-3647	18-3649	18-0398	
5.7L (GEN +) FWC	350/V-8	1998-2002	L010037	M599999	18-3531			18-3568	18-3555	18-1508	
5.7L (GEN +) ALPHA	350/V-8	1998-2002	L010037	M599999				18-3647	18-3649	18-0398	
5.7L (GEN +) BRAVO	350/V-8	1998-2002	L010037	M599999	18-3530-1			18-3647	18-3649	18-0398	
5.7L (GEN +) FWC	350/V-8	2002-2010	M600000	& SUP				18-3647	18-3649	18-0398	
5.7L (GEN +)	350/V-8	2002-2010	M600000	& SUP				18-3647	18-3649	18-0398	
5.7L EFI FWC	350/V-8	1995-1996	F225560	K001505				18-3647	18-3649	18-0398	18-0398
5.7L EFI FWC	350/V-8	1997-2001	K001506	M299999	18-3531			18-3568	18-3555	18-1508	
5.7L EFI ALPHA	350/V-8	1995-2001	F355305	M299999				18-3647	18-3649	18-0398	
5.7L EFI BRAVO	350/V-8	1995-2001	F225560	M299999	18-3530-1			18-3647	18-3649	18-0398	
5.7L EFI MIE (GEN +) FWC	350/V-8	1997	K040300	K999999	18-3531			18-3568	18-3555	18-1508	
5.7L EFI MIE (GEN +)	350/V-8	1997	K040300	K999999	18-3530-1			18-3647	18-3649	18-0398	
5.7L MIE	350/V-8	1988-1995	B788152	F600999	18-1994		18-1977-1	18-3668	18-3551	18-2554	18-2553
5.7L MIE	350/V-8	1988-1995	B788152	F622099				18-3668	18-3551	18-1713	18-2917
5.7L MIE	350/V-8	1988-1995	B788152	F622099				18-3668	18-3555	18-7173	18-2917
5.7L MIE FWC	350/V-8	1988-1996	B788152	K04306				18-3647	18-3649	18-2844	
5.7L MIE FWC	350/V-8	1997-2002	K040307	M316999	18-3531			18-3568	18-3555	18-1508	
5.7L MIE	350/V-8	1996-2002	F622100	M316999				18-3647	18-3649	18-0398	
5.7L MIE FWC	350/V-8	2002-2010	M317000	& SUP				18-3647	18-3649	18-0398	
5.7L MIE	350/V-8	2002-2010	M317000	& SUP				18-3647	18-3649	18-0398	
5.7L MPI HORIZON MIE	350/V-8	2008-2010	A0900000	& SUP				18-3647	18-3649	18-0398	
5.7L MPI MIE FWC	350/V-8	2008-2010	A0900000	& SUP				18-3647	18-3649	18-0398	
5.7L MPI MIE FWC DTS	350/V-8	2008-2010	A0900000	& SUP				18-3647	18-3649	18-0398	
5.7L MPI MIE FWC EC	350/V-8	2008-2010	A0900000	& SUP				18-3647	18-3649	18-0398	
5.7L MPI MIE FWC EC DTS	350/V-8	2008-2010	A0900000	& SUP				18-3647	18-3649	18-0398	
5.7L MPI MIE	350/V-8	2008-2010	A0900000	& SUP				18-3647	18-3649	18-0398	
5.7L MPI MIE EC	350/V-8	2008-2010	A0900000	& SUP				18-3647	18-3649	18-0398	
5.7L MPI SKI	350/V-8	2008-2010	A0900000	& SUP				18-3647	18-3649	18-0398	
5.7L MPI SKI EC	350/V-8	2008-2010	A0900000	& SUP				18-3647	18-3649	18-0398	
5.7L SKI	350/V-8	1985-1995	A338553	F775199	18-1994		18-1977-1	18-3668	18-3551	18-2554	18-0398
5.7L SKI	350/V-8	1987-1995	B514627	F775199				18-3668	18-3551	18-1713	18-0398
5.7L SKI	350/V-8	1987-1995	B514627	F775199				18-3668	18-3551	18-1713	18-0398
5.7L SKI	350/V-8	1996-2002	F775200	M316999	18-3530-1			18-3647	18-3649	18-0398	
5.7L SKI	350/V-8	2002-2010	M317000	& SUP				18-3647	18-3649	18-0398	
5.7LX ALPHA	350/V-8	1995-1997	F601000	K999999				18-3647	18-3649	18-0398	
5.7LX BRAVO	350/V-8	1995-1997	F601000	K999999	18-3530-1			18-3647	18-3649	18-0398	
5.7LX RWC	350/V-8	1996	F601000	K001526				18-3647	18-3649	18-2844	18-0398
5.7LX RWC	350/V-8	1997	K001527	K999999	18-3531			18-3568	18-3555	18-1508	
5.7LX BRAVO EFI (GEN +) FWC	350/V-8	1996	F800300	K001508				18-3647	18-3649	18-2844	18-0398
5.7LX BRAVO EFI (GEN +) FWC	350/V-8	1997	K001509	K999999				18-3568	18-3555	18-0398	
5.7LX BRAVO EFI (GEN +)	350/V-8	1996-1997	F800300	K999999	18-3530-1			18-3647	18-3649	18-0398	
5.7LX EFI FWC	350/V-8	1996	F752400	K001505				18-3647	18-3649	18-2844	18-0398
5.7LX EFI FWC	350/V-8	1997	K001506	K999999	18-3531			18-3568	18-3555	13-0398	
5.7LX EFI ALPHA	350/V-8	1996-1997	F752400	K999999				18-3647	18-3649	18-0398	
5.7LX EFI BRAVO	350/V-8	1996-1997	F752400	K999999	18-3530-1			18-3647	18-3649	18-0398	
5.7 GM ALPHA			F225560	0K999999				18-3647	18-3649	18-2917	—
5.7 GM BRAVO			F225560	0K999999				18-3647	18-3649	18-2917	—
5.7L/EFI GM ALPHA			L010037	SUP				18-3647	18-3649	18-2917	—
5.7L/EFI GM BRAVO			L010037	sUP				18-3647	18-3649	18-2917	—
5.7L MIE			F025000	0F622099				18-3647	18-3649	18-2844	—
5.7L MIE			F622100	0K999999				18-3647	18-3649	18-2917	—
5.7L MIE			F622100	0K999999				18-3647	18-3649	18-2844	—
5.7L MIE			L002003	SUP				18-3647	18-3649	18-2917	—
BLACK SCORPION SKI	350/V-8	1996-2001	0F800000	M391599	18-3530-1			18-3647	18-3649	18-0398	
BLACK SCORPION SKI	350/V-8	2003-2006	M391600	W690192				18-3647	18-3649	18-0398	
BLACK SCORPION SKI	350/V-8	2006-2007	W690193	W698432				18-3647	18-3649	18-0398	
BLACK SCORPION SKI	350/V-8	2003-2007	M391600	W698433				18-3647	18-3649	18-0398	
SCORPION 350	350/V-8	2008-2010	W698433	& SUP				18-3647	18-3649	18-0398	
SCORPION 350	350/V-8	2008-2010	W698433	& SUP				18-3647	18-3649	18-0398	
SCORPION 350 EC	350/V-8	2008-2010	W698433	& SUP				18-3647	18-3649	18-0398	
233 MCM (FORD)	351/V-8	1975-1977	4173000	4902304				18-3646	18-3551	18-2834	
233 MIE (FORD)	351/V-8	1975-1977	4173000	4902304				18-3646	18-3551	18-2834	
255 MCM/MIE (FORD)	351/V-8	1973-1974	3258728	4178299				18-3646	18-3551	18-2834	
377 MAG FWC	377/V-8	2008-2010	A300000	& SUP				18-3647	18-3649	18-0398	
377 MAG FWC DTS	377/V-8	2008-2010	A300000	& SUP				18-3647	18-3649	18-0398	
377 MAG FWC EC	377/V-8	2008-2010	A300000	& SUP				18-3647	18-3649	18-0398	
377 MAG FWC EC DTS	377/V-8	2008-2010	A300000	& SUP				18-3647	18-3649	18-0398	
377 MAG	377/V-8	2008-2010	A300000	& SUP				18-3647	18-3649	18-0398	
377 MAG	377/V-8	2008-2010	A300000	& SUP				18-3647	18-3649	18-0398	
377 MAG EC	377/V-8	2008-2010	A300000	& SUP				18-3647	18-3649	18-0398	
377 SCORPION MCM	377/V-8	1999-2005	L416146	M907201			18-1977-1	18-3551	18-3551	18-0398	18-2553
377 SCORPION SKI	377/V-8	1997-1998	K000656	L600314				18-3647	18-3649	18-0398	
MX 6.2L MPI FWC	377/V-8	2000-2001	L680003	M299999	18-3531			18-3568	18-3555	18-0398	
MX 6.2L MPI	377/V-8	2000-2001	L680003	M299999	18-3530-1			18-3647	18-3649	18-0398	
MX 6.2L MPI FWC	377/V-8	2002	M300000	M599999				18-3568	18-3555	18-0398	
MX 6.2L MPI FWC	377/V-8	2002-2007	M600000	A299999				18-3647	18-3649	18-0398	
MX 6.2L MPI	377/V-8	2002-2007	M300000	A299999				18-3647	18-3649	18-0398	
MX 6.2L MPI	377/V-8	2002-2007	M300000	A299999				18-3647	18-3649	18-0398	
MX 6.2L MPI HORIZON	377/V-8	2002	M300000	M599999				18-3568	18-3555	18-0398	
MX 6.2L MPI HORIZON	377/V-8	2002-2007	M600000	A299999				18-3647	18-3649	18-0398	
MX 6.2L MPI HORIZON MIE	377/V-8	2002	M300000	M316999				18-3568	18-3555	18-0398	
MX 6.2L MPI HORIZON MIE	377/V-8	2002-2010	M317000	& SUP				18-3647	18-3649	18-0398	
MX 6.2L MPI MIE FWC	377/V-8	1999-2002	L670000	M316999				18-3568	18-3555	18-0398	
MX 6.2L MPI MIE FWC	377/V-8	2002-2010	M317000	& SUP				18-3647	18-3649	18-0398	
MX 6.2L MPI MIE FWC DTS	377/V-8	2008-2010	A0900000	& SUP				18-3647	18-3649	18-0398	
MX 6.2L MPI MIE FWC EC	377/V-8	2008-2010	A0900000	& SUP				18-3647	18-3649	18-0398	
MX 6.2L MPI MIE FWC EC DTS	377/V-8	2008-2010	A0900000	& SUP				18-3647	18-3649	18-0398	
MX 6.2L MPI MIE	377/V-8	2002-2010	M300000	& SUP				18-3647	18-3649	18-0398	
MX 6.2L MPI MIE	377/V-8	2008-2010	A0900000	& SUP				18-3647	18-3649	18-0398	
MX 6.2L BLACK SCORPION	377/V-8	2001-2002	L005601	M391599	18-3530-1			18-3647	18-3649	18-0398	

- ① Diseño I
- ② Diseño II
- ③ Diseño III
- ④ Aluminio escape Manifold
- ⑤ Colector escape Manifold
- ⑥ Refrigeración cerrado
- ⑦ Refrigeración estándar
- ⑧ Con bola retención
- ⑨ Sin bola retención
- ⑩ SN 4167000 & Sup
- ⑪ Termostato aloj. Original aparece como la NLA Kit actualización

APLICACIÓN TERMOSTATO(Cont.)

Motores / Modelos	CID / # CIL	Intervalo Año	Desde Serial #	Hasta Nº Serie #	Alojamiento	Tapa termostato	Termostato & Kit junta	Termostato	Requiere junta	Requiere juntas - Diseño II	Requiere Juntas - Diseño III
MX 6.2L BLACK SCORPION	377N-8	2003-2006	M391600	W690192	⑨		18-3647	18-3649	18-0398		
MX 6.2L BLACK SCORPION	377N-8	2006-2007	W690192	W698432	⑨		18-3647	18-3649	18-0398		
SCORPION 377	377N-8	2008-2010	W698433	& SUP	⑨		18-3647	18-3649	18-0398		
SCORPION 377	377N-8	2008-2010	W698433	& SUP	⑩		18-3647	18-3649	18-0398		
SCORPION 377 HO EC	377N-8	2008-2010	A091488	A092170	⑧		18-3647	18-3649	18-0398		
325 MCM/MIE	427N-8	1969-1972	2278747	3780449	⑥		18-3646	18-3551	18-2553		18-0398
330 (WITH MERC TRANS)	454N-8	1977-1981	4623115	6083144	⑦		18-3646	18-3551	18-2844	18-0398	
330 (WITH B/W) FWC	454N-8	1982-1987	6083145	B816540	⑥		18-3646	18-3551	18-2553		18-0398
330 (WITH B/W)	454N-8	1982-1987	6083145	B816540	18-3678	⑦	18-3668	18-3551	18-2554	18-2553	18-0398
330 MIE (WITH MERC TRANS)	454N-8	1977-1980	4623115	5889913			18-3646	18-3551	18-2844	18-0398	
340 MIE FWC	454N-8	1981-1987	5889914	B788365		③	18-3646	18-3551	18-2553	18-2844	18-0398
340 MIE	454N-8	1981-1987	5889914	B788365	18-3678	⑦	18-3668	18-3551	18-2554	18-2844	18-0398
340 MIE	454N-8	1981-1987	5889914	B788365		⑦ ⑨	18-3668	18-3551	18-2554	18-2553	18-0398
340/7.4L MIE			5889914	OD715493			18-3646	18-3649	18-2553	18-2844	18-2917
350 MIE	454N-8	1974-1976	3780450	4623109			18-3646	18-3551	18-2844	18-0398	
350 GM (MAGNUM)			A635178	B525981			18-3668	18-3551	18-2553	18-2554	
350 GM (MAGNUM)	③		B525982	SUP	ES		18-3668	18-3551	18-2553	18-2554	
350 GM (MAGNUM)	④		B525982	SUP	▲		18-3668	18-3551	18-2552	18-7173	
350 GM (MAGNUM)	④		B525982	SUP	18-3648	▲	18-3648	18-3649	18-2552	18-7173	
370	454N-8	1978-1985	4179554	6721527			18-3646	18-3551	18-2553	18-2844	18-0398
370	454N-8	1985-1987	6721528	B714586			18-3668	18-3551	18-2554	18-2553	18-0398
370 TRS GM			4179554	6721527			18-3651	18-3551	18-2553	18-2844	
370 TRS GM			6721528	SUP			18-3668	18-3551	18-2553	18-2554	
390 GM			2781129	2825059			18-3651	18-3551	18-2553	18-2844	
390 GM MCM/MIE			2781129	3042731			18-3646	18-3649	18-2553	18-2844	18-2917
400	454N-8	1980-1986	4179554	OB457644			18-3646	18-3551	18-2553	18-2554	18-0398
400 TRS GM			4179554	SUP			18-3651	18-3551	18-2553	18-2844	
420 GM			A398941	SUP	18-3651		18-3651	18-3551	18-2553	18-2844	
420	454N-8	1987-1989	A398941	B622418	18-1994		18-3646	18-3551	18-2553	18-2844	18-0398
425	454N-8	1990-1993	A398941	D937011	18-3678			18-3551	18-2553	18-2554	18-0398
440	454N-8	1983-1986	4179554	B485220			18-3646	18-3551	18-2553	18-2844	18-0398
450	454N-8	1995-1996	F347100	F347277	18-1994		18-3646	18-3551	18-2553	18-2844	18-0398
525 SC	454N-8	1991-1999	D456000	L415623			18-3646	18-3551	18-2553	18-2844	18-0398
454 MAG ALPHA	454N-8	1986-1988	A631894	B785148	18-3678	①	18-3668	18-3551	18-2554	18-2553	18-0398
454 MAG ALPHA	454N-8	1986-1988	A631894	B785148		② ⑤	18-3668	18-3551	18-7173	18-2552	18-0398
454 MAG BRAVO	454N-8	1988-1992	B721206	D805068	18-3678	①	18-3668	18-3551	18-2554	18-2553	18-0398
454 MAG BRAVO	454N-8	1995-1997	F305000	K999999		② ⑨	18-3647	18-3649	18-0398		
454 MAG BRAVO	454N-8	1988-1992	B721206	D805068		② ⑨	18-3668	18-3551	18-7173		18-0398
454 MAG BRAVO	454N-8	1992-1994	D805069	F304999		② ⑨	18-3668	18-3551	18-7173		18-0398
454 MAG EFI	454N-8	1995-1997	F115700	F802349		⑦	18-3647	18-3649	18-0398		
454 MAG EFI SKI	454N-8	1995-1997	F215800	K999999		⑦	18-3647	18-3649	18-0398		
454 MAG MPI	454N-8	1996-2001	F802350	M024999		⑦	18-3647	18-3649	18-0398		
454 MAG MPI FWC	454N-8	1998-2001	L010029	M024999	18-3531	③	18-3568	18-3555	18-0398		
454 MAG MPI HORIZON MIE	454N-8	1998-2001	L002200	L674000	18-3531	③	18-3568	18-3555	18-0398		
454 MAG MPI SKI	454N-8	1996-1997	F820100	K999999		⑦	18-3647	18-3649	18-0398		
525 SC	454N-8	1991-1999	D456000	L415623			18-3646	18-3551		18-2553	18-0398
7.4L BRAVO	454N-8	1995-1997	OF352000	OK999999		⑦	18-3647	18-3649	18-0398		
7.4L BRAVO	454N-8	1988-1991	B771113	D603117	18-3678	①	18-3668	18-3551	18-2554	18-2553	18-0398
7.4L BRAVO	454N-8	1988-1991	B771113	D603117		② ⑤	18-3668	18-3551	18-7173	18-2552	18-0398
7.4L BRAVO	454N-8	1992-1994	D603118	F351999		② ⑨	18-3668	18-3551	18-7173	18-2552	18-0398
7.4L EFI MIE	454N-8	1996-1997	F874815	K999999		⑦	18-3647	18-3649	18-0398		
7.4L EFI MIE FWC	454N-8	1996-1997	F874815	K999999	18-3531	③	18-3568	18-3555	18-0398		
7.4L MIE FWC	454N-8	1988-1992	B788366	D715493		③	18-3646	18-3551	18-2553	18-2844	18-0398
7.4L MIE	454N-8	1988-1992	B788366	D715493		③ ⑤	18-3668	18-3551	18-2554	18-2553	18-0398
7.4L MIE	454N-8	1989-1994	C391564	D715493		⑦	18-3668	18-3551	18-7173	18-2552	18-0398
7.4L MIE FWC	454N-8	1989-1994	C391564	D715493		③	18-3646	18-3551	18-2553	18-2844	18-0398
7.4L MIE	454N-8	1989-1994	D715494	F349999		⑦	18-3668	18-3551	18-7173	18-2552	18-0398
7.4L MIE FWC	454N-8	1989-1994	D715494	F820141		⑦	18-3646	18-3649	18-2553	18-2844	18-0398
7.4L MIE	454N-8	1995-1996	F350000	F820141		⑦	18-3647	18-3649	18-0398		
7.4L MIE	454N-8	1996-1997	F820142	K999999		⑦	18-3647	18-3649	18-0398		
7.4L MIE	454N-8	1996-1997	F820142	K999999		③	18-3647	18-3649	18-2844	18-0398	
7.4L MPI	454N-8	1998-2001	L010003	M024330		⑦	18-3647	18-3649	18-0398		
7.4L MPI MIE	454N-8	1995-2001	F563052	M025999		⑦	18-3647	18-3649	18-0398		
7.4L MPI MIE FWC	454N-8	1995-2001	F563052	M025999		③	18-3568	18-3555	18-0398		
7.4LX BRAVO EFI	454N-8	1996-1997	F820000	K999999		⑦	18-3647	18-3649	18-0398		
7.4L BRAVO MPI	454N-8	1996-1997	F602010	K999999		⑦	18-3647	18-3649	18-0398		
7.4L MIE			OC391564	OF349999			18-3646	18-3649	18-2553	18-2844	18-2917
7.4L MIE			OC391564	OF349999			18-3646	18-3649	18-2553	18-2844	18-2917
390 MCM/MIE	482N-8	1969-1970	2781129	3042731			18-3646	18-3551	18-2553	18-2844	18-0398
460	482N-8	1983-1986	4179554	6181046			18-3668	18-3551	18-2554	18-2553	18-0398
465	502N-8	1990-1994	C849992	F213244	18-3678			18-3551		18-2553	18-0398
470			4208730	6218036			18-3652	18-3552	18-2843		
470			6218037	SUP			18-3667	18-3555	18-2555		
485			5685394	SUP			18-3652	18-3552	18-2555		
488			6170297	SUP			18-3667	18-3555	18-2555		
500	502N-8	1994-1998	F213293	L001772	18-1994		18-1977-1	18-3551		18-2553	18-0398
500 (GEN +)	502N-8	1999	L414639	L601036	18-1994		18-1977-1	18-3551		18-2553	18-0398
500 EFI	502N-8	1999-2005	L001477	M907127			18-1977-1	18-3551		18-2553	18-0398
502 MAG	502N-8	1990-1993	C878221	F114528		③	18-3668	18-3551	18-7173	18-2552	18-0398
502 MAG EFI	502N-8	1993-1995	D840650	F802599		⑦	18-3647	18-3649	18-0398		
502 MAG MPI	502N-8	1996-1997	F802600	K999999		⑦	18-3647	18-3649	18-0398		
502 MAG MPI FWC	502N-8	1998-2001	L017000	M024999	18-3531	③	18-3568	18-3555	18-0398		
525 EFI	502N-8	2003-2010	M900146	& SUP			N/A		18-1508		
575 GM			0A677429	OD763716			18-3646	18-3649	18-2553	18-2844	18-2914
575			A677429	SUP			18-3651	18-3551	18-2553	18-2844	
8.2L MAG	502N-8	2010	A350340	& SUP					18-1508		
8.2L MIE EC	502N-8	2010	A350802	& SUP					18-1508		
8.2L MIE	502N-8	1990-1992	C878221	D857199		⑦	18-3668	18-3551	18-7173	18-2552	18-0398
8.2L MIE FWC	502N-8	1990-1992	C878221	D857199		③	18-3668	18-3551	18-2553	18-2844	18-0398
8.2L MIE	502N-8	1									



18-7702
SENSOR DE TEMPERATURA
Reemplaza: 805223T
Para: Mercruiser V6 & V8(350, 454, 496 & 502 cid)Motores MPI



18-5897
SENSOR
Reemplaza: 97257A1, 806490T, 97257, 806490, 811091, 36525
Para temperatura agua
3/8" - 18 NPT



18-5898
SENSOR
Reemplaza: 97258A1, 97258, 34625, FI6900198, FI6900152
Para temperatura agua
1/2" -14 NPT



18-5899
SENSOR PRESIÓN DE ACEITE
Reemp: 90806, 815425T, 90806A1, 815425, 34623, 8M0068784
Para presión de aceite

APLICACIÓN SENSOR TEMPERATURA/SENSOR PRESIÓN ACEITE

Modelo	Serie #	Presión Aceite	Temperatura Agua	Modelo	Serie #	Presión Aceite	Temperatura Agua
ROVER	31400000F & SUP	—	18-5897	270	2851074-3077735	18-5899	18-5897
110	1565944-1566081	18-5899	18-5898	280	4176250 & SUP	18-5899	18-5898
110	1602980 & SUP	18-5899	18-5898	300 MR/TRS	6668677 & SUP	18-5899 ②	18-5897 ②
120	2324346 & INF	18-5899	18-5898	320	A543604 & SUP	18-5899 ②	18-5897 ②
120	2324347 & SUP	18-5899 ① ②	18-5897 ②	325	2278747 & SUP	18-5899	18-5897 ⑧ ⑨
140 (4 cil/3.0)	2508061 - 3462607	18-5899 ②	18-5897 ②	330	4623115 & SUP	18-5899	18-5898
140 (4cil/3.0)	4512156 & SUP	18-5899 ②	18-5897 ②	330/W.B.W.	6083145 & SUP	18-5899 ②	18-5897 ②
3.0L/3.0LX	C856559 & SUP	18-5899 ②	18-5897 ②	340/7.4L	5889914 & SUP	18-5899 ②	18-5897 ②
140 (6 cil)	1566119-1725960	18-5899	18-5898	350	3780450 & SUP	18-5899	18-5898
150	1666495-2048046	18-5899	18-5898	350 (Magnum)	A635178- B525981	18-5899 ②	18-5897 ②
160	2048022-2770031	18-5899	18-5897 ④ ⑤	350 (Magnum)	B525982-0505449	—	18-5897 ② ⑥ ⑦
165	2770032 & SUP	18-5899	18-5897	350 (Magnum)	D505450 & SUP	18-5899 ②	18-5897 ②
165/3.7L/170/180	6916779 & SUP	18-5899	—	370 (TRS)	4179554 & SUP	18-5899 ②	18-5897 ②
175 (262 CID)	B527955 & SUP	18-5899 ②	18-5897 ② ⑥ ⑦	390	2781129-2825059	18-5899	18-5897
4.3L (Generation II)	D714107 & SUP	18-5899 ②	18-5897 ②	400	4179554 & SUP	18-5899	18-5897
185 (229 CID)	6330183 & SUP	18-5899 ②	18-5897 ②	420/425	A398941 & SUP	18-5899 ②	18-5897 ②
185 (262 CID)	A331455 & SUP	18-5899 ②	18-5897 ②	440	4179554 & SUP	18-5899	18-5897
190	1504311-1730903	18-5899	18-5898	454 (Magnum)	A631894 & SUP	18-5899 ②	18-5897 ②
190 (4 cil)	6916779 & SUP	18-5899	—	454 (Bravo)	B721206-D805068	18-5899 ②	18-5897 ② ⑥ ⑦
200	2453769-271202	18-5899	18-5897	460	4179554	18-5899	18-5897
200	6218462 & SUP	18-5899 ②	18-5897 ②	465	C849992 & SUP	18-5899 ②	18-5897 ②
200/5.0	B525982 & SUP	—	18-5897 ② ⑥ ⑦	500	C577254 & SUP	18-5899 ②	18-5897 ②
205 (262 CID)	A331455 & SUP	18-5899 ②	18-5897 ②	502 (Bravo)	C878221 & SUP	18-5899 ②	18-5897 ②
205 (4.3L)	B527955 & SUP	18-5899 ②	18-5897 ② ⑥ ⑦	502 (Bravo Gen V)	D824589 & SUP	—	18-5897
4.3LX (Generation II)	D714370 & SUP	18-5899 ②	18-5897 ②	525	D456000 & SUP	18-5899 ②	18-5897 ②
215	2781153 & SUP	18-5899	18-5897	575	A677429 & SUP	18-5899 ②	18-5899 ②
225 (Ford)	3385721 & SUP	18-5899	18-5897	888	3108723 & SUP	18-5899	18-5897
225 (GM)	1632308-2694014	18-5899	18-5897 ⑧ ⑨	898	4762210-6218461	18-5899	18-5898
228	4765100-6218461	18-5899	18-5898	898	6218462 & SUP	18-5899 ②	18-5897 ②
228 & 230	6218462 & SUP	18-5899 ②	18-5897 ②	5.7	A338553-B514626	18-5899 ②	18-5897 ②
230 (I.B.)	5907058 & SUP	18-5899 ②	18-5897 ②	5.7	B514627-B525981	18-5899 ②	18-5897 ② ⑥ ⑦
230 (5.0)	B522506 & SUP	18-5899 ⑩	18-5897 ⑥ ⑦	5.7 (Bravo)	B525982 & SUP	—	18-5897 ⑥ ⑦
233 Ford	4173000 & SUP	18-5899	18-5898	7.4 (Bravo)	B771113-D803117	18-5899 ②	18-5897 ② ⑥ ⑦
250	9314301-4908849	18-5899	18-5897 ⑧ ⑨	7.4 (Bravo Gen V)	D803118 & SUP	—	18-5897 ②
255	3258728 & SUP	18-5899	18-5898	7.4L (Hurth)	TODOS	18-5899 ②	18-5897 ②
260	4908850-6218461	18-5899	18-5898	454	D805069 & SUP	—	18-5897 ②
260	6218462 & SUP	18-5899 ②	18-5897 ②	8.2	C878221-D857199	18-5899 ②	18-5897 ②
260/5.7	B522506 & SUP	18-5899 ⑩	18-5897 ⑥ ⑦	8.2	D857200 & SUP	—	18-5897 ②
260	5907058 & SUP	18-5899 ②	18-5897 ②				

① S/N - 3377341-3461707 & 5192049 & SUP

② No incluye aplicación doble

④ 2326096 & SUP

⑤ 2233574 & INF use 18-5898

⑥ (3/8 - 18)

⑦ (1/2 -14) Use 18-5898

⑧ encendido eléctrico

⑨ encendido automático

⑩ Sólo N/S B525981



18-70948
MANGUITO

Reemplaza: 32-808033

Para: 262 Mag EFI Bravo con sistema refrigeración combustible (1996-97), 4.3L EFI (TBI) (1998-01), 5.0L (Gen+) Bravo (1998-07), 5.0L EFI (Gen+) (1998-01), 350 Mag Alpha (Gen+) (1997), 350 Mag Alpha EFI (Gen+) (1997), 350 Mag Bravo MPI (Gen+) (1997), 350 Mag MPI (Gen+) (1998-01), 5.7L (1997), 5.7L (Gen+) (1998-07), 5.7L EFI (1997), 5.7L EFI (Gen+) 1998-2001, 5.7LX (1997), 5.7LX Bravo EFI (Gen+) (1997), 5.7LX EFI (1997)

Para: Del enfriador al alojamiento termostato



18-70949
MANGUITO

Reemplaza: 32-807407

Para: 454 Mag MPI (Gen VI) (1996-01), 7.4LX MPI Bravo (Gen VI) (1996-97), 502 Mag MPI (Gen VI) (1996-01) Para: Del enfriador al alojamiento termostato



18-70954
MANGUITO

Reemplaza: 32-8600891, 32-860089

Para: 5.0L (Gen+) Bravo (1998-07), 5.0L EFI (Gen+) Alpha & Bravo (1998-01), 350 Mag Alpha (1997), 350 Mag EFI (Gen+) Alpha (1997), 350 Mag EFI (Gen+) Alpha (1997), 350 Mag MPI (Gen+) Bravo (1997-01), 350 Mag MPI (Gen+) Alpha (1998-01), 5.7L Alpha & Bravo (1997), 5.7L (Gen+) Alpha & Bravo (1998-07), 5.7L EFI Bravo (1997-01), 5.7LX Alpha & Bravo (1997), 5.7LX EFI (Gen+) Alpha & Bravo (1997), 6.2L MPI (2000-01) Para: Refrigerador aceite a refrigerador aceite.



18-70956
MANGUITO

Reemplaza: 32-16012

Para: MC175/205 (1987), 4.3L (1988-92), 4.3L (Gen II) (1992-95), 4.3LX (Gen II) (1992-95) Para: Para refrigerador aceite a alojamiento termostato con molde 4 conectores de manguito dentro del alojamiento termostato (Sin conector "T") Dos mangueras al colector y dos mangueras al codo.



18-70955
MANGUITO

Reemplaza: 32-16011

Para: MC200/230 (1987), 5.0L Alpha (1988-95), 5.0LX Alpha (1988-95), MC260 (1987), 350 Mag Alpha (1987-95), 5.7L Alpha & Bravo (1988-95), 454 Mag Bravo (1988-92), 7.4L (GenV) Bravo (1992-96)

Para: Refrigeración del aceite del termostato con los 4 conectores emitidos al termostato (No "T" conector) Dos mangueras al colector y dos mangueras al codo.



18-70952
MANGUITO

Reemplaza: 32-887952

Para: 5.0 L Bravo (1988-95), 5.0LX Bravo (1988-95), 350 Mag MPI Bravo (1995), 350 Mag MPI (Gen+) Bravo (1996), 5.7L Bravo (1988-96), 5.7L EFI 1995, 5.7L EFI Bravo (1996), 5.7LX EFI (Gen+) Bravo (1996) Para: De la bomba de agua marina del enfriador de aceite



18-70953
MANGUITO

Reemplaza: 32-8080441

Para: 5.0L EFI (Gen+) Bravo (1998-01), 350 Mag MPI (Gen+) (1998-01), 5.7L Bravo (1997), 5.7L (Gen+) Bravo (1998-07), 5.7L EFI Bravo 1997, 5.7L EFI (Gen+) Bravo (1998-01), 5.7LX Bravo (1997), 5.7LX EFI (Gen+) Bravo (1997), 6.2L MPI (2000-01) Para: De la bomba de agua marina al enfriador de aceite



18-70951
MANGUITO

Reemplaza: 32-860205, 32-807962, 32-807961

Para: 262 Mag, EFI Bravo (1996-97), 4.3L (Gen+) Bravo (1998-07), 4.3L TBI (Gen+) Bravo (1998-01), 4.3LH (Gen+) Bravo (1998-02), 4.3LX(H) (Gen+) Bravo (1996-97) Para: De la bomba de agua marina al enfriador de aceite



18-70945
MANGUITO

Reemplaza: 32-862139

Para: 4.3L (Gen+) (1998-07), 4.3L EFI (Gen+) (1998-01), 4.3LH (Gen+) (1998-02) Para: Termostato alojamiento a babor con colector de escape de 2 piezas



18-70947
MANGUITO

Reemplaza: 32-862124

Para: 4.3L (Gen+) (1998-07) (S/N 0L619000 & SUP), 4.3L EFI (Gen+) (2000-01), 4.3LH (Gen+) (2000-02) Para: termostato alojamiento a estribor con colector de escape de 2 piezas



18-70946

MANGUITO

Reemplaza: 32-8066362

Para: 262 Mag EFI (Gen+) (1996-97), 4.3L (Gen+) (1998-07) (S/N 0L01004-0L618999), 4.3L EFI (Gen+) (1998-00), 4.3LH (Gen+) 1998-00, 4.3LX (Gen+) (1996-97), 4.3LXH (Gen +) (1996-97)

Para: termostato alojamiento a estribor con colector de escape de 2 piezas



18-70958

MANGUITO

Reemplaza: 32-96246A4, 32-96246A1, 32-96246

Para: MC898 (1983-84), MC200 (1985-87), MC228 (1982-84), MC230 (1985-87), 5.0L & 5.0LX Alpha (1988-95), MC260 (1983-87), 300 Tempest MR (1985-86), MC320 EFI (1987-89), 350 MAG Alpha (1986-96), 5.7L Alpha (1988-96), 5.7LX & 5.7LX EFI Alpha (1996), 454 MAG Alpha (1986-88)

Para: Del transom al enfriador de aceite



18-70933

MANGUITO

Reemplaza: 32-861634, 32-89718, 32-46828, 32-16010

Para: 3.0L I/L 4 (1999 & Sup)



18-70934

MANGUITO

Reemplaza: 32-897181

Para: 330 (1977-87), 330 MIE (1977-80), 340 MIE W/ BW (1981-87), 370 TRS (1978-87), 400 TRS (1980-86), 420 (1987-89), 425 (1990-92), 425 (Gen V) (1992-93), 440 TRS (1983-86), 450 (Gen V) (1995-96), 454 EFI (Gen V) (1994-96), 454 Mag Alpha (1986-88), 454 Mag Bravo (1988-92), 454 Mag Bravo(Gen V) (1992-97), 454 Mag MPI Bravo(Gen V) (1996-98), 454 Mag MPI SKI (Gen V)(1996-97), 460 TRS (1983-86), 465 (1990-92), 465 (Gen V) (1992-94), 500 Gen + (1999), 500 (Gen V) (1994-96), 500 (Gen V)(1997-98), 502 EFI (Gen V)(1993-95), 502 Mag Bravo (1990-92), 502 Mag MPI Bravo (Gen V), 502 Mag Bravo(Gen V)(1992-93), 502 Mag MPI(Gen V)(1996), 7.4L MIE W/BW (1988-92), 7.4L Bravo (1988-91), 7.4L Bravo(Gen V)(1992-96), 7.4L Bravo (Gen V)(1996-97), 7.4L MIE (LH) (Gen V)(1992-96), 7.4L MIE (LH)(Gen V)(1996-97), 7.4L MIE W/Hurth (1989-92), 7.4L MIE MPI (LH)(GEN V)(1996-97), 7.4L TBI MIE (LH)(Gen V)(1996-97), 7.4LX Bravo MPI(Gen V) (1996-97), 7.4LX Bravo TBI(Gen V)(1996-97), 8.2L MIE (Gen V)(1993-96), 8.2L MIE MPI (Gen V), 8.2



18-70935

MANGUITO

Reemplaza: 32-806856

Para: 200 2bbi (1987), 230 4bbi (1987), 260 (1987), 350 Mag SKI (1991-96), 350 Mag Alpha (1987-95), 350 Mag Alpha 4bbi (1996), 350 Mag Alpha EFI (Gen+)(1996), 350 Mag Mag MPI SKI (1995-96), 4.3L (Gen II)(2bbi)(1993-96), 4.3LX (Gen II)(4bbi)(1993-96), 5.0L 2bbi (1988-95), 5.0LX 4bbi (1988-95), 5.7L (1988-95), 5.7L 2bbi (1996), 5.7L Alpha EFI TBI (1995), 5.7L Bravo EFI TBI(1995), 5.7L Competition SKI (1996), 5.7L EFI (2bbi TBI) (1996), 5.7L MIE (1996), 5.7LX 4bbi (1996), 5.7LX Bravo EFI (Gen+)(1996), 5.7LX EFI 4bbi TBI (1996), Black Scorpion(Gen+)(1996) Para:Del enfriador de aceite al alojamiento del termostato



18-70938

MANGUITO

Reemplaza: 32-8066351

Para: 262 Mag con VST (1996-97), 4.3L-LX (1993-96) Design III, 5.0L-LX (1988-95) Design III, 350Mag-EFI-MPI (1987-96), 5.7L-LX 88-96 Design III.

Para: Del alojamiento de termostato al colector de babor



18-70939

MANGUITO

Reemplaza: 32-8066361

Para: 4.3L-LX (1993-96) Diseño refrigeración estándar III, 5.0L-LX/5.7L-LX (1988-95) estándar Cooling Design III, 350 Mag (1987-95) Refrigeración estándar Design III.

Para: Del alojamiento termostato al colector estribor



18-70940

MANGUITO

Reemplaza: 32-860144

Para: 262 Mag con refrigeración combustible, 4.3L-LX (1996 & Sup) con 1 pc. colector, 5.0L-EFI (1998 & Up), 350 Mag-MPI 97-01, 5.7L-EFI (1996-97), 6.2L MPI(20 01 & Sup).

Para: del alojamiento de termostato al colector babor



18-70943
MANGUITO
 Reemplaza: 32-897491
 Para: 7.4L, 454 Mag, 502 Mag. Del alojamiento de termostato al colector de babor



18-3601
MANGUERA ENTRADA AGUA
 Reemplaza: 32-32461, 32-32461A1
 Diámetro: $\frac{5}{8}$ "
 Largo $13 \frac{7}{8}$ "



18-3602
MANGUERA ENTRADA AGUA
 Reemplaza: 32-4172533, 32-8M0062309
 $13 \frac{7}{8}$ " Largo - $\frac{3}{4}$ " D.I.
 Para: MR, Alpha I, Gen II



18-3603
MANGUERA ENTRADA AGUA
 Reemplaza: 32-43437, 32-8M0062309



18-70925
MANGUITO
 Reemplaza: 32-160211, 32-87116, 32-16021
 Para: 4.3L, 5.0L, & 5.7L
 Para: Tapa termostato a colector de babor



18-70926
MANGUITO
 Reemplaza: 32-73796
 Para: 5.0L & 5.7L
 Para: Tapa termostato a codo escape



18-70927
MANGUITO
 Reemplaza: 32-73795
 Para: 5.0L & 5.7L Port
 Para: Para alojamiento al colector de babor



18-70928
MANGUITO
 Reemplaza: 32-71613
 Para: 5.0L & 5.7L
 Para: alojamiento termostato a enfriador aceite



18-70929
MANGUITO
 Reemplaza: 32-73794
 Para: 5.0L & 5.7L Estribor
 Para: alojamiento termostato a colector estribor



18-44092
MANGUITO
TRANSOM
 Reemplaza: Mercury 32-861635
 $1 \frac{1}{4}$ " (32mm) / $1 \frac{1}{8}$ " (25mm) D.I.
 Para: Mercruiser 3.0L



18-70930
MANGUITO
Reemplaza: 32-52481
Para: GM En línea 4 & 6 cil.
Para: Bloque distribución a tapa.



18-70931
MANGUITO
Reemplaza: 32-96879, 32-47640,
32-8M0071007
Para: 2.5L & 3.0L
Para: Bloque distribución a bomba agua



18-70932
MANGUITO
Reemplaza: 32-871171, 32-87117
Para: 4.3L, 5.0L, & 5.7L Estribor
Para: Tapa termostato a colector estribor



4 3/4"

18-70021
MANGUITO
3/4" DI



5"

18-70704
MANGUITO
Reemplaza: 32-89653
1 1/4" DI
Para: 3.7L

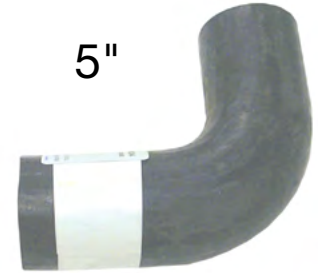

5"

18-70924
MANGUITO
1 3/4" DI



12 1/2"

18-71218
MANGUITO
Reemplaza: 32-48131
1" DI
Para: 230 & 260 MIE



12 3/4"

18-71337
MANGUITO
Reemplaza: 32-861590A05, 32-861590A2, 32-861590A1,
32-806825
1 3/4" DI
Para: 4.3L, 5.0L, 5.7L
Manguera bomba circulación

MANGUERAS



18-75100
MANGUERA
Trozo de 48"
1" DI



18-75125
MANGUITO
Trozo de 48"
1 1/4" DI

INTERCAMBIO MANGUITOS

Ref #	Mercuriser Ref #	Ref #	Mercuriser Ref #	Ref #	Mercuriser Ref #	Ref #	Mercuriser Ref #
18-70925	32-16021 1	18-70928	32-71613	18-70935	32-806856	18-70934	32-89718 1
18-3601	32-32461	18-70929	32-73794	18-70940	32-860144	18-70943	32-89749 1
18-71337	32-33189	18-70927	32-73795	18-70933	32-861634	18-70931	32-96879
18-3602	32-41725-33	18-70926	32-73796	18-71337	32-87108		
18-3603	32-43437	18-70938	32-806635 1	18-70932	32-87117 1		
18-71218	32-48132	18-70939	32-806636 1	18-70704	32-89653		
18-70930	32-52481						

CORREAS

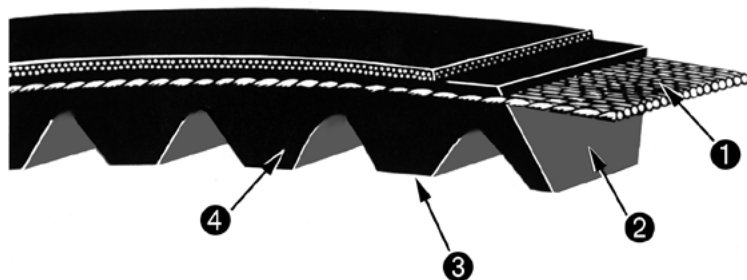

- 1 Cuerdas sintéticas de alta fuerza resiste fallo de carga de choque. Sus bajas propiedades de extensión aseguran el funcionamiento uniforme sobre la vida de la correa.
- 2 La sección de compresión es un compuesto especial de goma que asegura suavidad y la transferencia de carga fuerza a las cuerdas.
- 3 Los dientes son moldeados a tolerancias exactas de ingeniería para mejorar la flexibilidad y mantener el apoyo de cuerda. La geometría de los dientes proporciona un área grande para la circulación de aire para mantener la correa refrigerada y prevenir que el aumento de calor dañe la sección de cojín.
- 4 El estriado facilita que no patinen en contacto con la polea y una transmisión perfecta.

TAMAÑO CORREAS

Ref No.	OE #	Largo (pulgadas)	Ancho máxim(p.)	Ref No.	OE #	Largo (pulgadas)	Ancho máxim(p.)
18-15290	57-13457, 57-13457T, 57-13457Q, 57-53215, 57-53215T	29	29/64	18-15435	57-64416, 57-49211	43 1/2	29/64
18-15300	57-49756	30	29/64	18-15440	57-49213A1, 57-45856	44	29/64
18-15325	57-77274A1, 57-77274	32 1/2	29/64	18-15450	-	45	29/64
18-15345	57-74271T, 57-74271, 57-74271Q	34 1/2	29/64	18-15455	-	45 1/2	29/64
18-15370	57-65607T, 57-65607, 57-65607Q	37	29/64	18-15460	57-48120A1, 57-48120, 57-48120Q1	46	29/64
18-15380	-	38	29/64	18-15470	57-78200A1, 57-78200, 57-78200Q1	47	29/64
18-15390	57-52692	39	29/64	18-15480	57-48122, 57-48122Q	48	29/64
18-15400	57-32850, 57-69143T, 57-69143Q	40	29/64	18-15490	57-816295T, 57-816295Q	52 1/2	29/64
18-15405	57-76269, 57-76269Q	40 1/2	29/64	18-15495	57-91035A1, 57-91035Q1, 57-91035	49 1/2	29/64
18-15410	57-49043A1, 57-64032A1, 57-32850, 57-49043, 57-64032, 57-64032Q1, 57-816544	41	29/64	18-15500	57-96834T, 57-96834Q, 57-96834, 57-13458, 57-13458Q	50	29/64
18-15415	57-36356	41 1/2	29/64	18-15520	57-33170, 57-33170Q, 57-37619T	52	29/64
18-15430	57-49211, 57-64416	43	29/64	18-15550	57-13458T	55	29/64

Fits GM Big Block V8 454 cu. in. Models 330, 340 & 7.4L

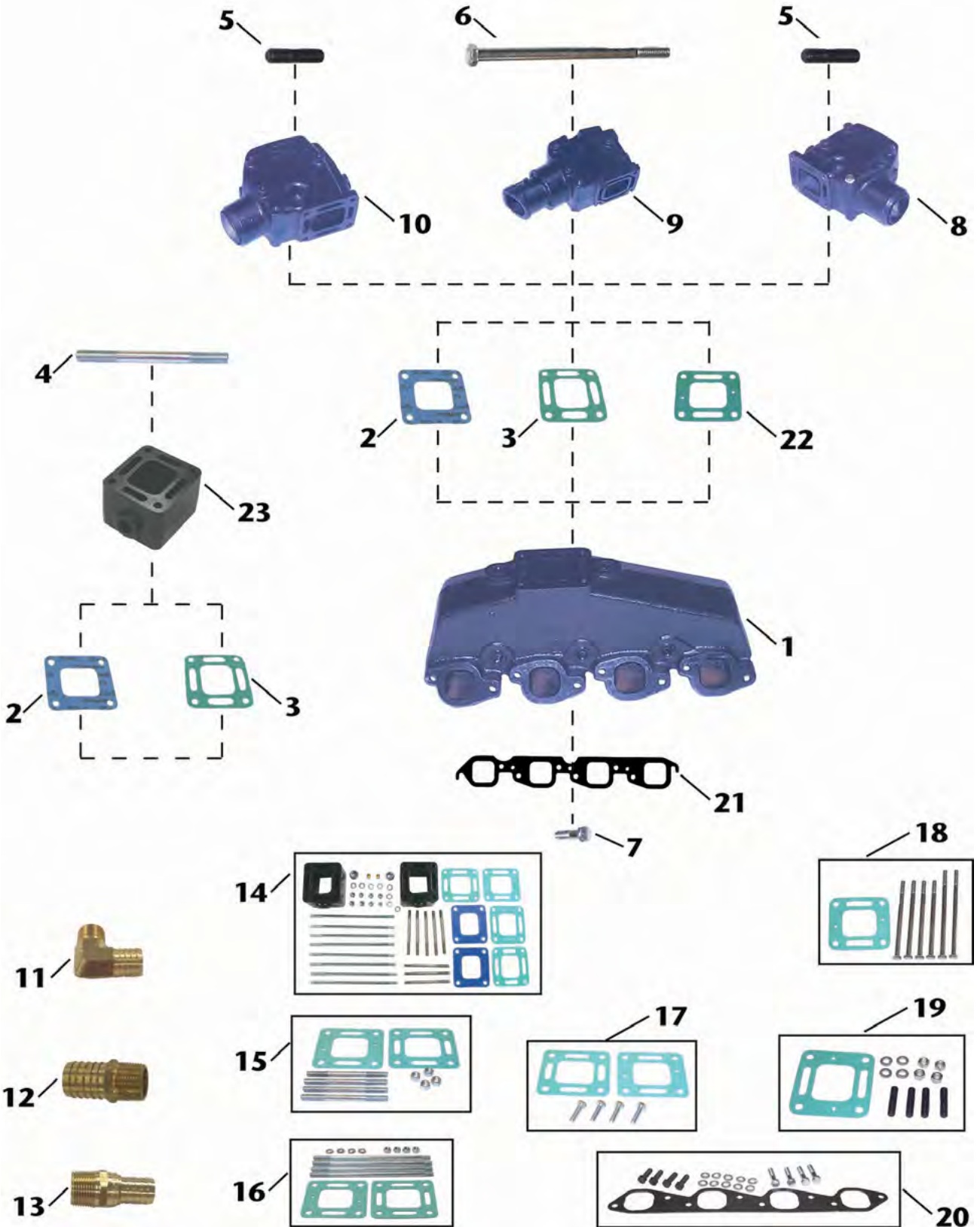

	Ref	Descripción	OE No.	Aplicación
1	18-1957 18-1957S	COLECTOR	807078A6	Bloque grande GM (V8) 454 cu.in. Modelos 330, 340 & 7.4L. Usar con 18-0418 Junta colector; Kit montaje: 18-8532
2	18-0672	JUNTA CODO (CERRADO)	27-860231	Para colector: 18-1957-1; codos: 18-1970-1, & 18-1976-2, 18-1974: espaciador 18-1908.
3	18-2849-1	JUNTA CODO (ABIERTO)	27-818832	Para colector: 18-1957-1; codos: 18-1970-1, & 18-1976-2, 18-1974: Espaciador 18-1908.
4	NSS	ESPARRAGO	N/D	Incluye en 18-8554 kit montaje.
5	NSS	ESPARRAGO	N/D	Incluye en 18-8529 kit montaje.
6	NSS	PERNO	N/D	Incluye en 18-8505 kit montaje.
7	NSS	PERNO	N/D	Incluye en 18-8532 kit montaje.
8	18-1974-1	CODO 3" mang. • 15° angulo	98502A2	Para colector: 18-1957-1. Usar juntas codo: 18-2849-1, 18-0897, o 18-0672; Usar montaje kit: 18-8529 (No usar con espaciador)
9	18-1976 18-1976S	CODO 4" mang. • 7° angulo	44354A3	Para colector: 18-1957-1. Usar junta codos: 18-2849-1, 18-0897, o 18-0672; Usar kit montaje: 18-8505, o si el espaciador esta incluido usar 18-8555
10	18-1970-1	CODO 3" manguera	98504A3	Para colector: 18-1957-1. Usar junta codo: 18-2849-1, 18-0897, or 18-0672; Usar kit montaje: 18-8529, o s el espaciador esta incluido usar 18-8554.
11	18-8216	ENTRONQUE	N/D	3/4" - 14NPT X 1" manguera (Entronque de bronce resistente a la corrosión)
12	18-4461	ENTRONQUE	N/D	3/4" - 14NPT X 1" manguera (entronque de bronce resistente a la corrosión)
13	18-8215	ENTRONQUE	N/D	3/4" - 14NPT X 3/4" manguera (Entronque de bronce resistente a la corrosión)
14	18-1908K	KIT ESPAC. COLECTOR	807476A6, 93320A5	3" kit codo para colector: 18-1957-1. Incluye (2) espaciadores, restrictor, abierto, & junta. Toda la tornilleria necesaria para su montaje.
15	18-8554	KIT DE MONTAJE	N/D	Usar kit de montaje 18-8554 cuando el espaciador 18-1908, codo 18-1970-1 y el codo 18-1974 se utilizan juntos. Incluido en 18-1908K. Incluye (1)juntas de codo 18-2849-1 & 18-0897.
16	18-8555	KIT DE MONTAJE	N/D	Usar con espaciador colector: 18-1908 con codo 18-1976-2. Incluye en 18-1908K. Incluye (1) juntas de codo 18-2849-1 & 18-0897 .
17	18-8556	KIT DE MONTAJE	N/D	Usar con espaciador colector: 18-1985. Incluye (1)juntas 18-2849-1 & 18-0897
18	18-8505	KIT DE MONTAJE	N/D	Usar con codo: 18-1976-2. Incluye juntas codo 18-0897.
19	18-8529	KIT DE MONTAJE	N/D	Usar con codo: 18-1970-1 & 18-1974-1. Incluye juntas codo 18-0897
20	18-8532	KIT DE MONTAJE	N/D	Usar con colector: 18-1957-1. Incluye junta colector 18-0418.
21	18-0418	KIT DE MONTAJE	96653 / 27-46820	Usar con colector: 18-1957-1. Incluye en kit montaje 18-8532.
22	18-0897	JUNTA CODO (RESTRICTOR)	27-41813	Para colector: 18-1957-1; Espaciadores de colector: 18-1985, & 18-1908; Codos: 18-1970-1, & 18-1976-2, 18-1974
23	18-1908	ESPACIADOR COLECTOR	93322A12	3" Espaciador colector: 18-1952-1. Usar con kit montaje 18-8556. (Nota: para montar codos al espaciador es necesario un kit separado)

Fits GM In-Line 6 Cylinder 250 & 292 cu. in. Models 165 & 200

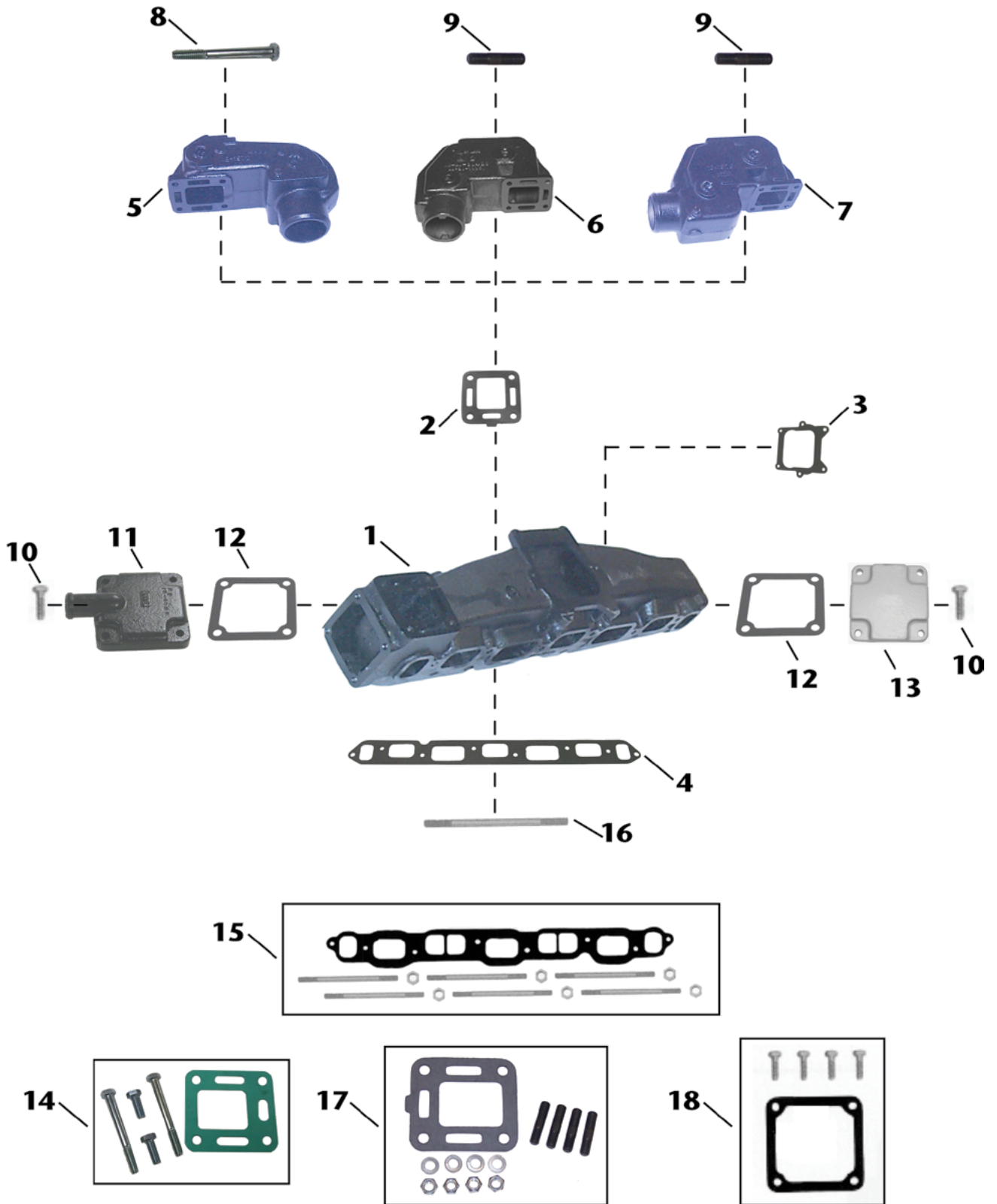

Ref	Descripción	OE No.	Aplicación
1	18-1960S COLECTOR	58759A10	GM Seis cilindros en línea 250 & 292 cu.in. Modelos 165 & 200. Usar con junta colector 18-2830-1; Kit de montaje 18-8531.
2	18-2833 JUNTA CODO	27-99777-2	Usar con codos: 18-1971, 18-1978 & 18-1972. Incluye en 18-4362 Kit de montaje.
3	18-0353 JUNTA CARBURADOR	27-58764	Para colector: 18-1960-1
4	18-2830-1 JUNTA COLECTOR	27-46401	Para colector: 18-1960-1. Incluye en kit montaje 18-8531.
5	18-1972 CODO	76325A2	Usar con colector: 18-1960-1; Junta de codo 18-2833
6	18-1971 18-1971S CODO	76351A2	Usar con colector: 18-1960-1; junta codo 18-2833; Kit de montaje 18-4362.
7	18-1978 CODO	76771A3	Usar con colector: 18-1960-1; junta codo 18-2833; Kit de montaje 18-4362.
8	NSS TORNILLO	N/D	Incluido en tornillería de montaje 18-8552.
9	18-3233 TORNILLO	16-49545	3/8-24, 3/8-16 X 1 3/4. Incluido en 18-4362 kit de montaje.
10	NSS TORNILLO	N/D	Incluido en 18-8512 kit de montaje.
11	18-4009 TAPA	60252A2	Para colector: 18-1960-1
12	18-2832-1 JUNTA	27-48043-1	Para babor y estribor: 18-1960-1. Incluido en kit de montaje 18-8512.
13	NSS PLATINA	N/D	Para colector: 18-1960-1
14	18-8552 KIT TORNILLERIA	N/D	Incluye sólo tornillería para codo 18-1972.
15	18-8531 KIT DE MONTAJE	N/D	Usar con colector: 18-1960-1. Incluye junta colector 18-2830-1
16	NSS TORNILLO	N/D	Incluido en 18-8531 kit de montaje.
17	18-4362 KIT DE MONTAJE	N/D	Usar con codos: 18-1971 & 18-1978. Incluye 18-2833 junta codos.
18	18-8512 KIT DE MONTAJE	N/D	Usar con tapa: 18-4009. Incluye junta 18-2832-1.



Fits GM V6 229 & 262 cu. in. Models 185 & 205

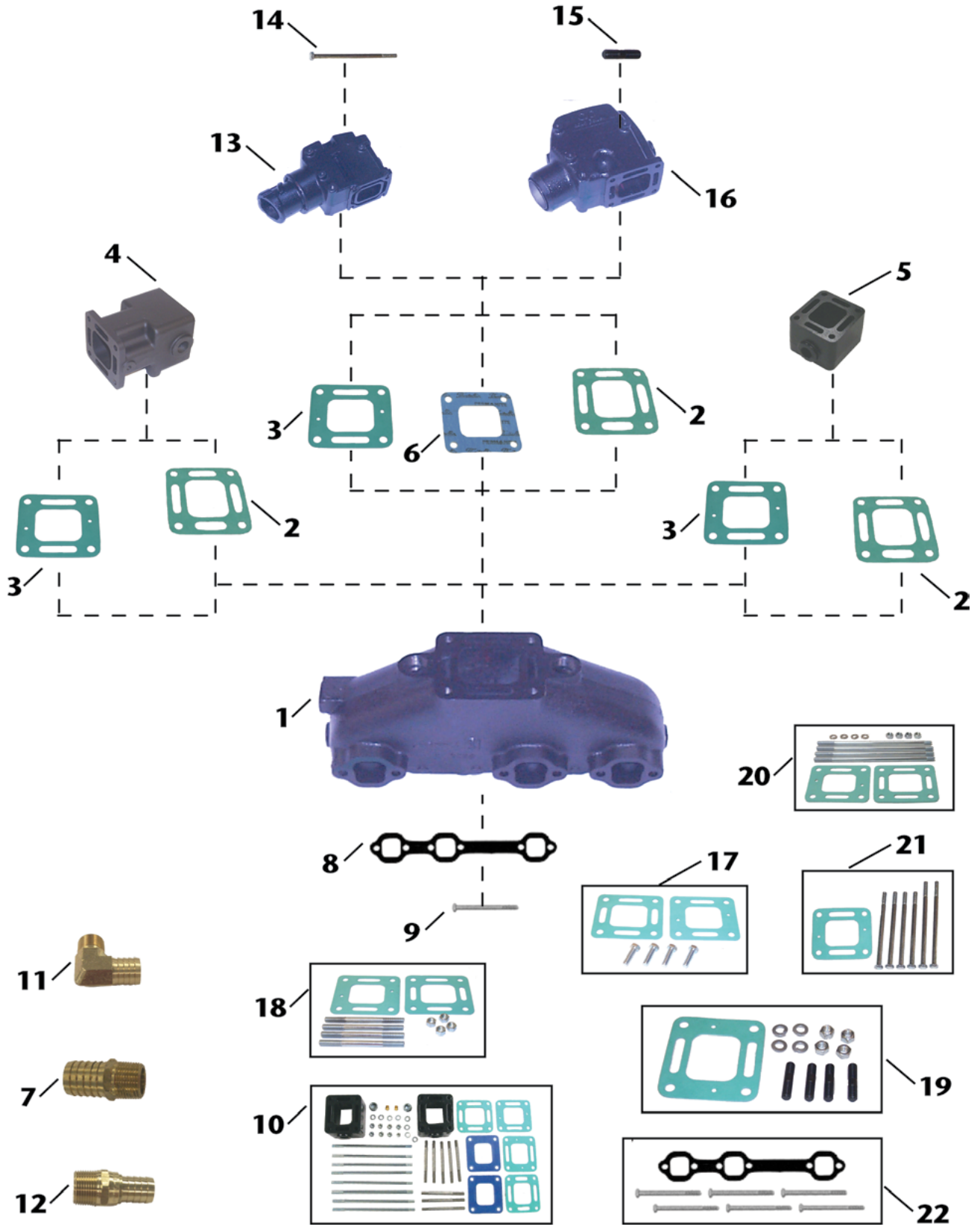

Ref	Descripción	OE No.	Aplicación	
1	18-1952 18-1952S	COLECTOR	99746A8	GM (V6) 229 & 262 cu.in. Modelos 185 & 205 (babor & estribor). Usar con junta colector: 18-2909; kit montaje: 18-8533
2	18-2849-1	JUNTA CODO (abierto)	27-818832	Se ajusta a colector: 18-1952-1; espaciadores: 18-1985, & 18-1908; Codo: 18-1970-1, & 18-1976-2
3	18-0897	JUNTA CODO (RESTRICTOR)	27-41813	Para colector: 18-1952-1; espaciadores: 18-1985, & 18-1908; codos: 18-1970-1, & 18-1976-2
4	18-1985	ESPACIADOR	93322A12	6" Espaciador para colector: 18-1952-1. Usar con kit de montaje 18-8556. (Nota: para montar codos al espaciador es necesario kit separado)
5	18-1908	ESPACIADOR	933220	3" Espaciador para colectores: 18-1952-1. Usar con kit montaje 18-8555 con 18-1976-2, o kit de montaje 18-8554 con 18-1970-1.
6	18-0672	JUNTA CODO (BLOQUEADO)	27-860231	Para colector: 18-1952-1; codo: 18-1970-1, & 18-1976-2
7	18-4461	ENTRONQUE	N/D	3/4" - 14NPT X 1" manguera (Entronque de bronce resistente a la corrosión)
8	18-2909	JUNTA COLECTOR	N/D	Junta para colector: 18-1952-1. Incluido en kit montaje 18-8533.
9	NSS	PERNO	N/D	Incluido en kit montaje 18-8533.
10	18-1908K	KIT ESPACIADOR COLECTOR	807476A6, 93320A5	3" kit codo para colector: 18-1952-1. Incluye (2) espaciadores, restrictor, junta abierta y cerrada. Toda la tornillería necesaria para el montaje esta incluida.
11	18-8216	ENTRONQUE	N/D	3/4" - 14NPT X 1" manguera (Entronque de bronce resistente a la corrosión)
12	18-8215	ENTRONQUE	N/D	3/4" - 14NPT X 3/4" (enronque de bronce resistente a la corrosión)
13	18-1976 18-1976 S	CODO COLECTOR 4" mang • 7° angulo.	44354A3, 807914A1	Para colector: 18-1952-1. Usar juntas codo: 18-2849-1, 18-0897, o 18-0672; Usar kit montaje: 18-8554
14	NSS	TORNILLO	N/D	Incluido en kit de montaje 18-8505.
15	NSS	TORNILLO	N/D	Incluido en kit de montaje 18-8529.
16	18-1970-1	CODO COLECTOR 3" mang • 0° angulo	98504A3	Para colector: 18-1952-1. Usar junta codo: 18-2849-1, 18-0897, or 18-0672; Usar kit de montaje: 18-8529, o si el espaciador esta incluido usar 18-8555.
17	18-8556	KIT DE MONTAJE	N/D	Usar con espaciador colector: 18-1985. Incluye (1) 18-2849-1 & 18-0897
18	18-8554	KIT DE MONTAJE	N/D	Usar con espaciador colector: 18-1908 con codo 18-1970-1. Incluido en 18-1908K. Incluye (1) junta codo 18-2849-1 & 18-0897.
19	18-8529	KIT DE MONTAJE	N/D	Usar con codo: 18-1970-1. Incluye junta codo 18-0897.
20	18-8555	KIT DE MONTAJE	N/D	Usar con espaciador colector: 18-1908 con codo 18-1976-2. Incluido en 18-1908K. Incluye (1) junta codo 18-2849-1 & 18-0897.
21	18-8505	KIT DE MONTAJE	N/D	Usar con codo: 18-1976-2. Incluye junta codo 18-0897.
22	18-8533	KIT DE MONTAJE	N/D	Usar con colector: 18-1952-1. Incluye junta colector 18-2909.

Fits GM Small Block V8 305-350 cu. in. Models 198, 228 & 898

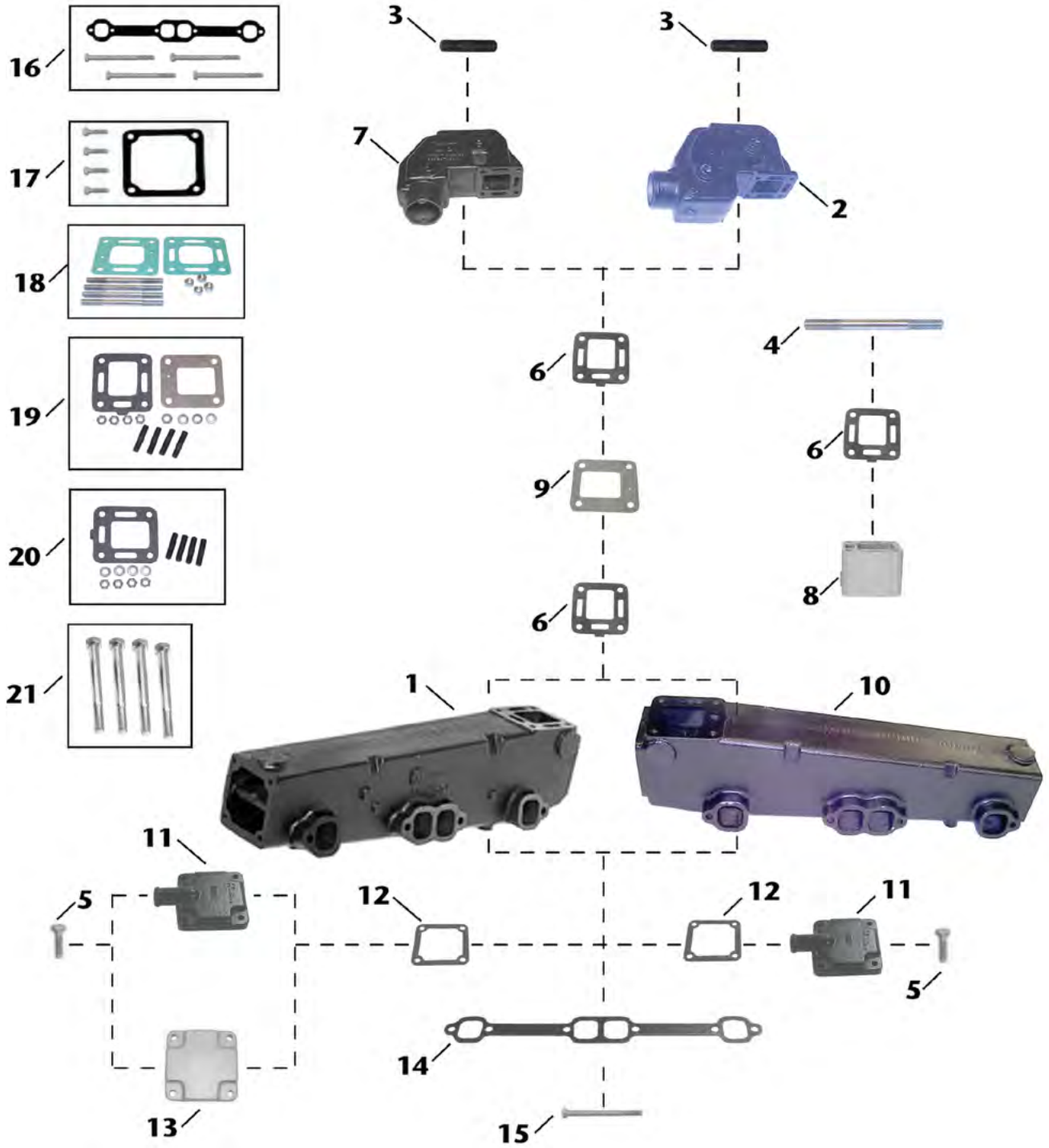

	Ref.	Descripción	OE No.	Aplicación
1	18-1951 18-1951S	COLECTOR (ESTRIBOR)	774235A2	GM bloque pequeño (V8) 305-350 cu.in. Modelos 198, 228, & 898. (estribor)
2	18-1978	CODO COLECTOR	76771A3	Usar con colectores: 18-1950-1, 18-1951-1; Junta con codo 18-2833; kit montaje 18-4362.
3	18-3233	TORNILLO	16-49545	3/8-24, 3/8-16 X 1 3/4. Incluido en 18-4362 kit montaje.
4	NSS	TORNILLO RAISER	N/D	Incluido en 18-8554 kit de montaje.
5	NSS	TORNILLO	N/D	Incluido en 18-8512 kit de montaje.
6	18-2833	JUNTA CODO	27-99777-2	Usar con codo: 18-1971 & 18-1978. Incluido en 18-4362 kit montaje.
7	18-1971	CODO COLECTOR	76351A2	Usar con colector: 18-1950-1, 18-1951-1; junta codo 18-2833; kit de montaje 18-4362.
8	18-1906	ESPACIADOR COLECTOR	61851	3" Espaciador colector: 18-1950-1, 18-1951-1. Usar con kit de montaje 18-8554 con codos 18-1971 o 18-1978.
9	18-4008	PLATINA	60207	Usar con colectores 18-1950-1, 18-1951-1. Requiere (2) junta codo 18-2833
10	18-1950S	COLECTOR (BABOR)	77234A2	GM bloque pequeño (V8) 305-350 cu.in. Modelos 198, 228, & 898. (babor)
11	18-4009	TAPA LATERAL	60252A2	Usar con colectores (babor & estribor) : 18-1950-1 & 18-1951-1; kit de montaje: 18-8512
12	18-2832-1	JUNTA	27-48043-1	Para estribor y babor: 18-1950-1, 18-1951-1. Usar con platina: 18-4009. Incluido en kit de montaje 18-8512.
13	NSS	TAPA LATERAL	54870	Para colector: 18-1950-1, 18-1951-1; kit montaje: 18-8512.
14	18-2949	JUNTA COLECTOR	96306	Usar con colector: 18-1951-1
15	NSS	TORNILLO	N/D	Incluido en kit de montaje 18-8520.
16	18-8520	KIT DE MONTAJE	N/D	Usar con colector: 18-1950-1, 18-1951-1. Incluye junta colector 18-2949.
17	18-8512	KIT DE MONTAJE	N/D	Usar con tapas laterales: 18-4009. Incluye junta tapa lateral 18-2832-1
18	18-8554	KIT DE MONTAJE	N/D	Usar con espaciador: 18-1908 con Riser 18-1971 o 18-1978 codos. Incluida en 18-1908K. Incluye (1) junta codo 18-2849-1 & 18-0897
19	18-8514	KIT DE MONTAJE	N/D	Usar con codos: 18-1971 & 18-1978. Incluye junta 18-2833 & 18-4008 junta tapa.
20	18-4362	KIT DE MONTAJE	N/D	Usar con codos: 18-1971 & 18-1978. Incluye junta codo 18-2833.
21	18-8548	KIT TORNILLERÍA	N/D	Incluye sólo tornillería para colectores 18-1950-1 & 18-1951-1. Incluido en kit de montaje 18-8520.

Fits Ford Small Block V8 302-351 cu. in. Models 215, 225, 233, 255 & 888

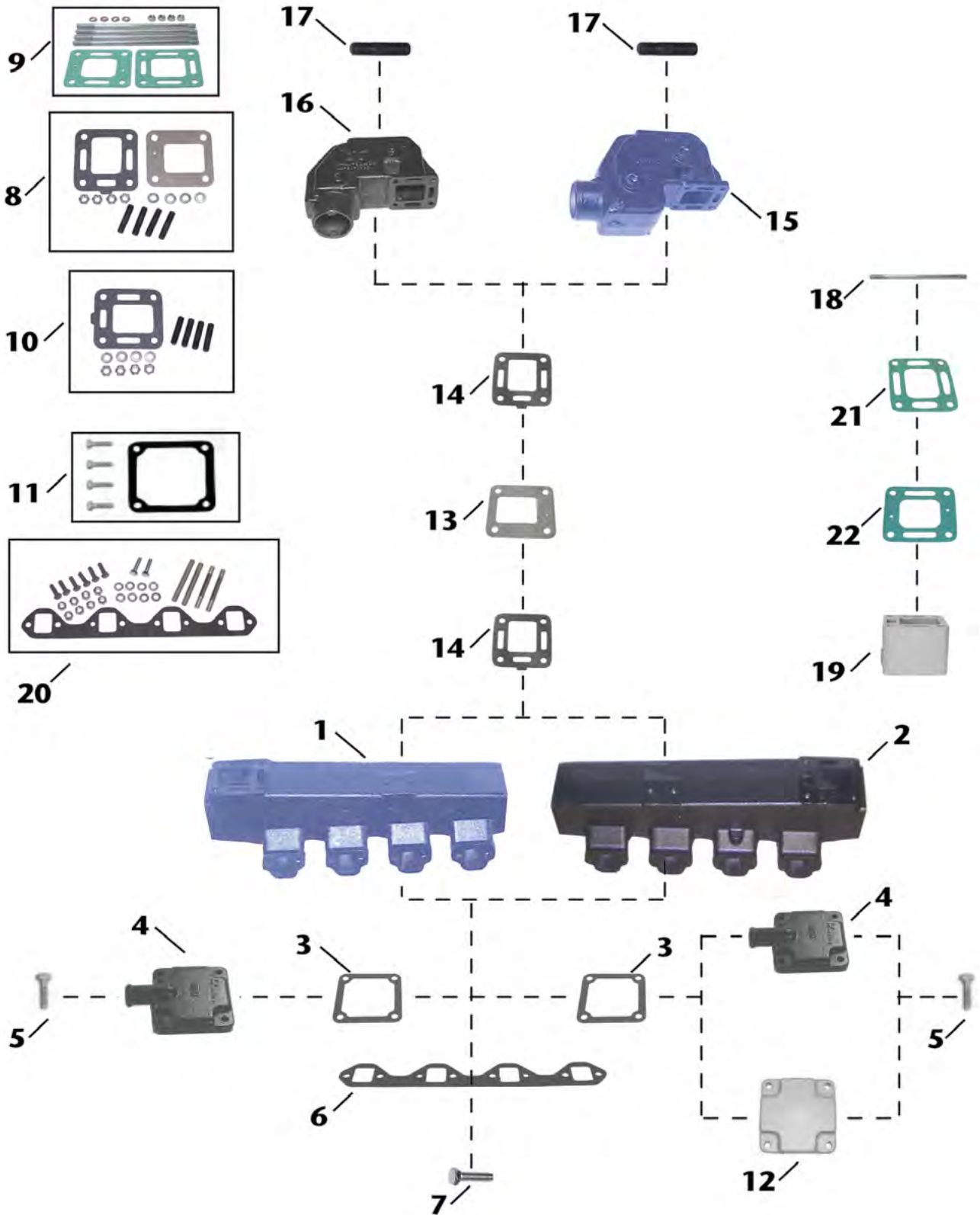

	Ref	Descripción	OE No.	Aplicación
1	18-1958-1	COLECTOR (BABOR)	65604A4	Bloque pequeño Ford (V8) 302-351 cu.in. Modelos 215, 225, 233, 255, & 888 (babor). Usar con junta colector: 18-0183-1; Kit de montaje 18-8509.
2	18-1962-1	COLECTOR (ESTRIBOR)	65603A4	Bloque pequeño Ford (V8) 302-351 cu.in. Modelos 215, 225, 233, 255, & 888 (estribor). Usar con junta colector: 18-0183-1; kit de montaje: 18-8509.
3	18-2832-1	JUNTA	27-48043-1	tapas colector para babor & estribor: 18-1958-1, 18-1962-1. Usar con tapa lateral: 18-4009. Incluido en el kit de montaje 18-8512.
4	18-4009	TAPA LATERAL	60252A2	Usar con colector (babor & estribor) : 18-1958-1, 18-1962-1; kit de montaje: 18-8512
5	NSS	TORNILLO	N/D	Incluido en kit de montaje 18-8512.
6	18-0183-1	JUNTA COLECTOR	27-73866	Usar con colector: 18-1958-1, 18-1962-1. Incluido en 18-8509 kit de montaje.
7	NSS	TORNILLO	N/D	Incluido en kit de montaje 18-8509.
8	18-8514	KIT DE MONTAJE	N/D	Usar con codos: 18-1971 & 18-1978. Incluye junta 18-2833 & junta codo 18-4008.
9	18-8554	KIT DE MONTAJE	N/D	Usar con espaciador: 18-1906 con codo 18-1971 o 18-1978. Incluye (1) 18-2849-1 & junta codo 18-0897.
10	18-4362	KIT DE MONTAJE	N/D	Usar con codos: 18-1971 & 18-1978. Incluye junta codo 18-2833.
11	18-8512	KIT DE MONTAJE	N/D	Usar con tapa lateral: 18-4009. Incluye junta 18-2832-1.
12	NSS	TAPA LATERAL	54870	Para colector: 18-1958-1, 18-1962-1; kit de montaje: 18-8512.
13	18-4008	JUNTA TAPA	60207	Usar con colector 18-1958-1, 18-1962-1. Requiere (2) juntas codo 18-2833.
14	18-2833	JUNTA CODO	27-99777-2	Usar con codos: 18-1971 & 18-1978. Incluido en kit de montaje 18-4362.
15	18-1978	CODO COLECTOR	76771A3	Usar con colector: 18-1958-1, 18-1962-1; junta codo 18-2833; kit de montaje 18-4362.
16	18-1971 18-1971S	CODO COLECTOR	76351A2	Usar con colectores: 18-1958-1, 18-1962-1; junta codo 18-2833; kit de montaje 18-4362.
17	18-3233	TORNILLO DE MONTAJE	16-49545	3/8-24, 3/8-16 X 1 3/4. Incluido en kit de montaje 18-4362.
18	NSS	TORNILLO DE MONTAJE	N/D	Incluido en kit de montaje 18-8554.
19	18-1906	ESPACIADOR COLECTOR	61851	3" Espaciador para colectores: 18-1950-1, 18-1951-1. Usar con kit de montaje 18-8554 con 18-1971 o codo 18-1978.
20	18-8509	KIT DE MONTAJE	N/D	Usar con colectores: 18-1958-1, 18-1962-1. Incluye junta colector 18-0183-1
21	18-2849-1	JUNTA CODO (ABIERTO)	27-818832	Para colector: 18-1958-1, 18-1962-1; espaciador colector: 18-1985. Incluye en kit de montaje 18-8554.
22	18-0897	JUNTA CODO (RESTRICTOR)	27-41813	Para colector: 18-1958-1, 18-1962-1; Espaciador colector: 18-1985. Incluido en kit de montaje 18-8554.

Fits GM 4 Cylinder 181 cu. in. Models 120, 140, 2.5L & 3.0L

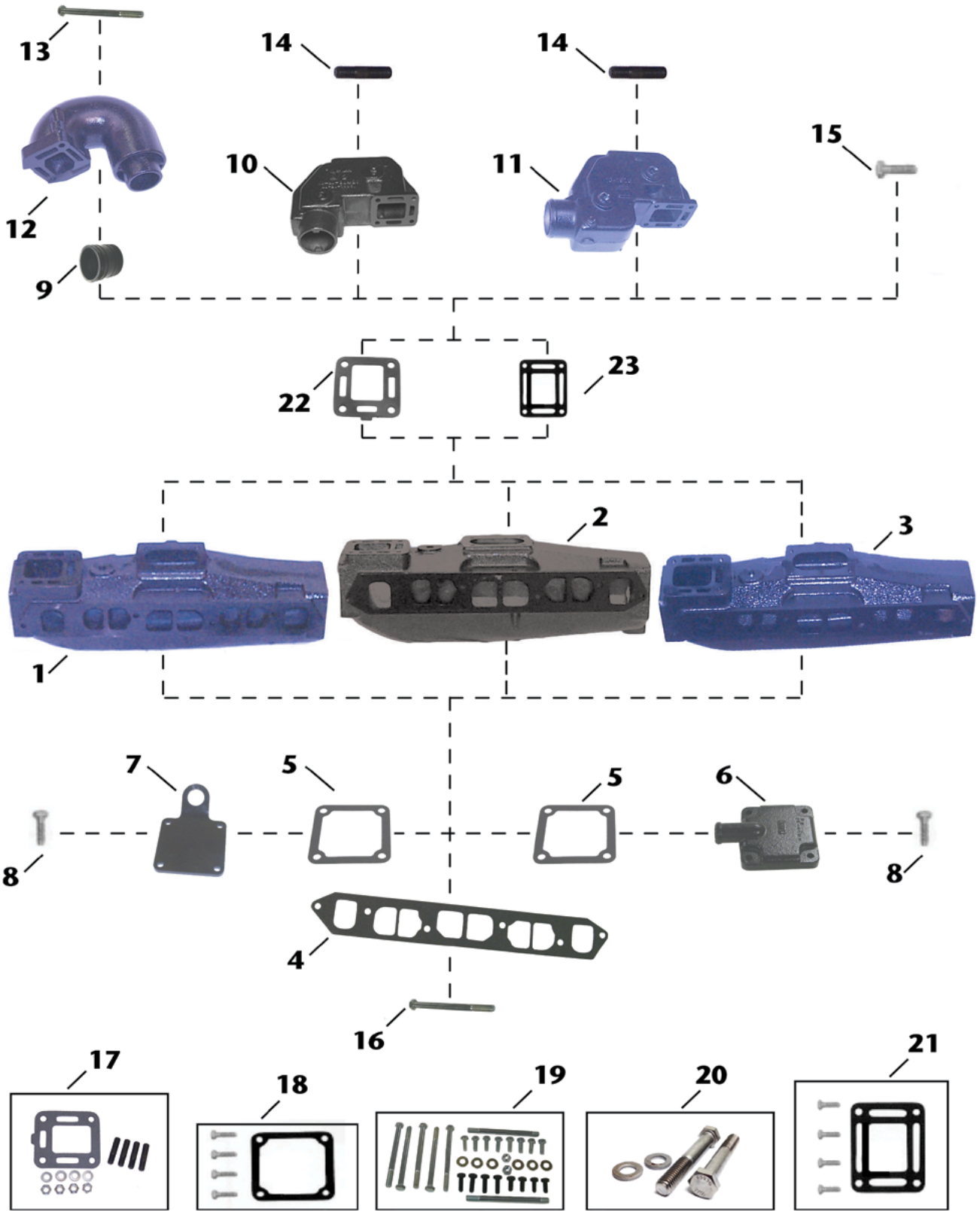

	Ref	Descripción	OE No.	Aplicación
1	18-1954-1	COLECTOR	9582A5	Para 2.5 & 3.0L 181 CID, Modelo 140 con carburador Rochester con starter eléctrico (1983-89). Usar con junta colector: 18-1204-1.
2	18-1955-1	COLECTOR	96705A1	Para 3.0L 181 CID, Modelo 140 con carburador Rochester con starter mecánico (1968-82). Usar con junta colector: 18-1204-1. montaje tornillería: 18-8549.
3	18-1956-2 18-1956S	COLECTOR	99798A18	Para 3.0L 181 CID, Modelo 140 & 3.0 con carb mercarb con starter eléctrico (1983-95). Usar con junta colector: 18-1204-1.
4	18-1204-1	JUNTA COLECTOR	27-96429	Para colector: 18-1954-1, 18-1955-1, 18-1956-2
5	18-2832-1	JUNTA	27-48043-1	Para babor & estribor tapas colector: 18-1954-1, 18-1955-1, 18-1956-2.
6	18-4009	TAPA LATERAL	60252A2	Para colector: 18-1954-1, 18-1955-1, 18-1956-2
7	18-5021	TAPA LATERAL	805629	Para colector: 18-1954-1, 18-1955-1, 18-1956-2
8	NSS	TORNILLO	N/D	Incluido en kit de montaje 18-8512 .
9	18-2748	UNION MANGUITO	32-44348T	4" Diámetro interior. Usar con codo 18-1975-1.
10	18-1971 18-1971S	CODO COLECTOR	76351A2	Usar con colector: 18-1954-1, 18-1955-1, 18-1956-2; junta colector 18-2833; kit montaje 18-4362
11	18-1978	CODO COLECTOR	76771A3	Usar con colector: 18-1954-1, 18-1955-1, 18-1956-2; junta codo 18-2833; Kit montaje 18-4362
12	18-1975 18-1975S	CODO COLECTOR	12076A2	Usar con colector: 18-1954-1, 18-1955-1, 18-1956-2; junta codo 18-2819-1; kit de montaje 18-8551: Manguito de escape 18-2748.
13	NSS	TORNILLO	N/D	Incluido en kit de montaje 18-8551.
14	18-3233	TORNILLO	N/D	3/8-24, 3/8-16 X 1 3/4. Incluido en kit de montaje 18-4362.
15	NSS	TORNILLO	N/D	Incluido en kit de montaje 18-8508.
16	NSS	TORNILLO	N/D	Incluido en kit de montaje 18-8549.
17	18-4362	KIT DE MONTAJE	N/D	Usar con codos: 18-1971 & 18-1978. Incluye junta codo 18-2833.
18	18-8512	KIT DE MONTAJE	N/D	Usar con tapa lateral: 18-4009 & tapa lateral (NSS). Incluye junta tapa lateral 18-2832-1.
19	18-8549	KIT DE MONTAJE	N/D	Incluye sólo tornillería para colector 18-1955-1.
20	18-8551	KIT DE MONTAJE	N/D	Incluye sólo tornillería para codo 18-1975-1.
21	18-8508	KIT DE MONTAJE	N/D	Usar con codo 18-1973. Incluye junta codo 18-2819-1.
22	18-2833	JUNTA CODO	27-99777-2	Usar con codos: 18-1971 & 18-1978. Incluido en kit de montaje 18-4362
23	18-2819-1	JUNTA CODO	27-39915	Usar con codos: 18-1973. Incluido en kit de montaje 18-8508.

Fits GM Small Block V8 305 & 350 cu. in. Models 200, 228, 230, 260 & 898

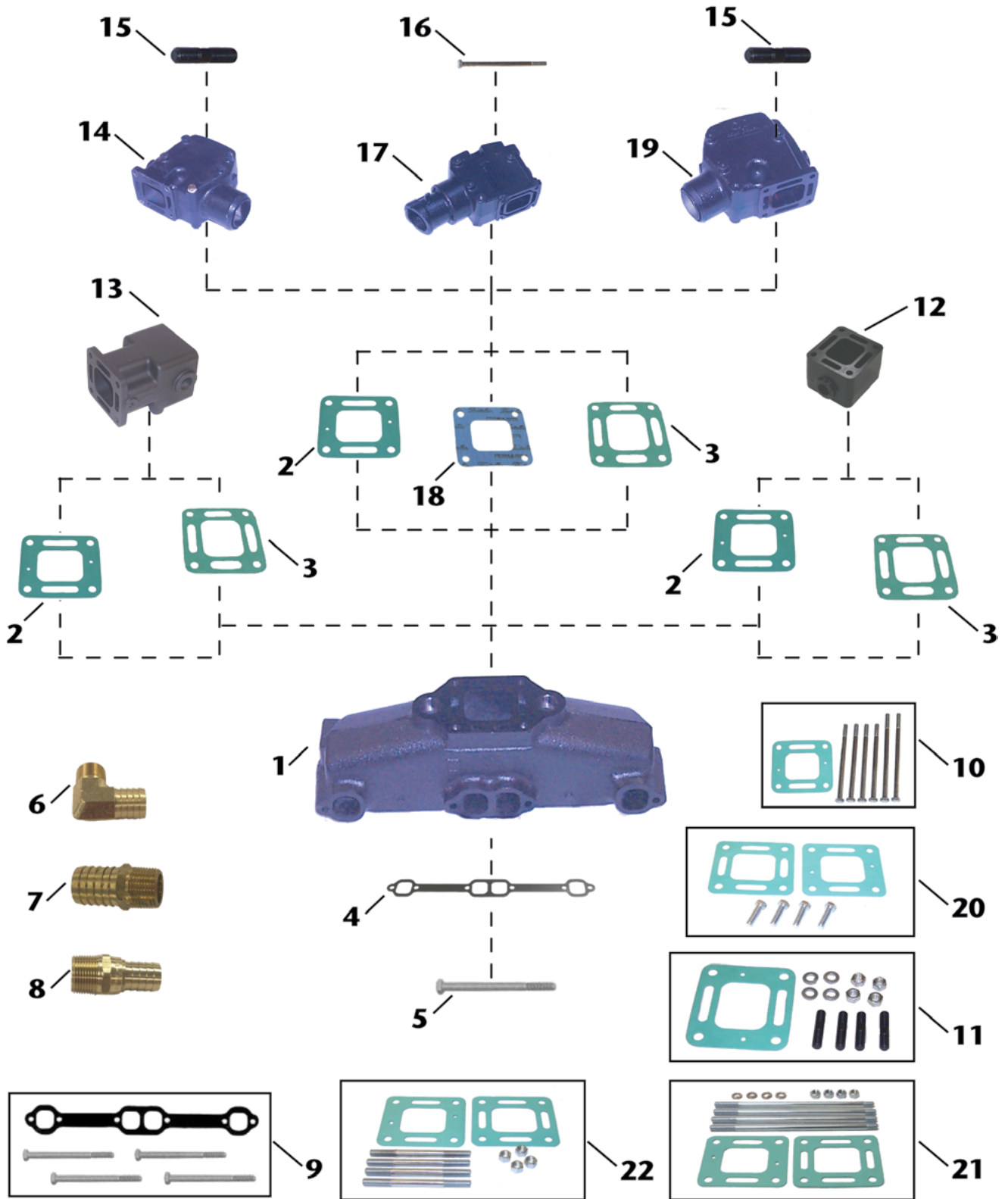

	Ref	Descripción	OE No.	Aplicación
1	18-1953 18-1953S	COLECTOR	87114A19	Bloque pequeño GM (V8) 305-350 cu.in. Modelos 200, 228, 230, 260, & 898
2	18-0897	JUNTA CODO (RESTRICTOR)	27-41813	Para colector: 18-1953-2; Espaciador colector: 18-1985, & 18-1908; Codo: 18-1970-1, 18-1976-2, 18-1974-1
3	18-2849-1	CODO JUNTA (ABIERTO)	27-818832	Para colector: 18-1953-2; Espaciador colector: 18-1985, & 18-1908; Codo: 18-1970-1, 18-1976-2, 18-1974-1
4	18-2949	JUNTA COLECTOR	96306	Usar con colector: 18-1953-2. Incluido en kit montaje 18-8520.
5	NSS	TORNILLO	N/D	Incluido en kit montaje 18-8520.
6	18-8216	ENTRONQUE	22-36305	3/4" - 14NPT X 1" Entronque de bronce resistente a la corrosión
7	18-4461	ENTRONQUE	N/D	3/4" - 14NPT X 1" Entronque de bronce resistente a la corrosión
8	18-8215	ENTRONQUE	N/D	3/4" - 14NPT X 3/4" Entronque de bronce resistente a la corrosión
9	18-8520	KIT DE MONTAJE	N/D	Usar con colector: 18-1953-2. Incluye junta colector 18-2949.
10	18-8505	KIT DE MONTAJE	N/D	Usar con codo: 18-1976-2. Incluye junta codo 18-0897.
11	18-8529	KIT DE MONTAJE	N/D	Usar con codo: 18-1970-1, 18-1974-1. Incluye juntas codo 18-0897.
12	18-1908	ESPACIADOR COLECTOR	933220A12	3" Espaciador colector: 18-1953-2. Usar con kit de montaje 18-8554 con 18-1970-1, o kit de montaje 18-8555 con 18-1976-2.
13	18-1985	ESPACIADOR COLECTOR	93322	6" Espaciador colector: 18-1953-2. Usar con kit de montaje 18-8556. (Nota: para montar codos al espaciador es necesario un kit separado)
14	18-1974-1	CODO COLECTOR 3" mang • 0° angulo	98502A2	Para colector: 18-1953-2. Usar junta codo: 18-2849-1, 18-0897, o 18-0672; Usar kit montaje: 18-8529. (No usar con espaciador)
15	NSS	TORNILLO	N/D	Incluido en kit montaje 18-8529.
16	NSS	TORNILLO	N/D	Incluido en kit de montaje 18-8505.
17	18-1976-2	CODO COLECTOR 4" mang • 7° angulo	44354A3, 807914A1	Para colector: 18-1953-2. Usar junta codo: 18-2849-1, 18-0897, o 18-0672; Usar kit de montaje: 18-8505, si el espaciador está incluido 18-8555.
18	18-0672	JUNTA CODO (CERRADA)	27-860231	Para colector: 18-1953-2; espaciador colector: 18-1985, & 18-1908; Codo: 18-1970-1, 18-1976-2, 18-1974-1
19	18-1970-1	CODO COLECTOR 3" mang • 15° angulo	98504A3	Para colector: 18-1953-2. Usar junta codo: 18-2849-1, 18-0897, o 18-0672; Usar kit montaje: 18-8529, si el espaciador esta incluido 18-8554.
20	18-8556	KIT DE MONTAJE	N/D	Usar con espaciador colector: 18-1985. Incluye 18-0897 & 18-2849-1. (Nota: para montar codos al espaciador es necesario un kit separador)
21	18-8555	KIT DE MONTAJE	N/D	Usar con kit de codos 18-1908K: espaciador 18-1908: codo 18-1976-2: Colector: 18-1953-1
22	18-8554	KIT DE MONTAJE	N/D	Usar con kit codos 18-1908K: espaciador 18-1908: codo 18-1970-1: colector: 18-1952-1

COLECTORES SIERRA

ESTÁN PINTADOS, INCLUYEN KIT DE JUNTAS & VERIFICADOS CONTRA FUGAS

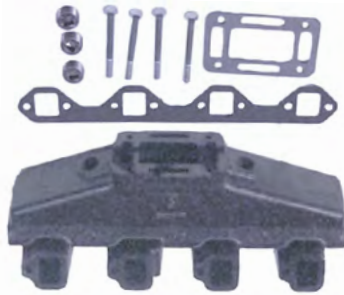

18-1998 HGE
18-1998S
COLECTOR ESCAPE
Babor & estribor
Reemplaza: Barr FM-1-83
Codo colector centrado
Para: Motores Ford 302 y 351 CID
Incluye kit de montaje 18-4363
Usar con:
Juego de juntas colector escape: 18-0603
***Para el despiece - Ver páginas 628-629**



18-1997-1
COLECTOR ESCAPE
Babor & estribor
Reemplaza: Barr CHV-1-83 Codo colector centrado
Para: motores GM 283, 305, 307 y 350 CID
Usar con:
Juego de juntas colector escape: 18-0604
***Para despiece - Ver páginas 626-627**



18-1898
COLECTOR
Babor & estribor
Reemplaza: Barr CHVA-1-84, Marine Power 0991-110
Para 454 cu. in. motores GM bloque grande V8
Usar con:
Junta colector escape: 18-0418
Codo: 18-1939, 18-1999
***Para despiece - Ver Páginas 624-625**



18-1951-1*
COLECTOR
Suministrado con kit de montaje
Reemplaza: 77235A2, 77235A8
ESTRIBOR
Para mayoría de bloques Mercruiser pequeños (GM)
Usar con:
Junta colector escape: 18-2949
Kit montaje: 18-8548



18-1950 HGE
18-1950S
COLECTOR
Suministrado con kit montaje
Reemplaza: 77234A2, 77234A7
BABOR
Para mayoría de bloques Mercruiser pequeños(GM)
Usar con:
Juntas colector escape: 18-2949
kit montaje: 18-8548



18-1952 HG3
18-1952S
COLECTOR
Babor & estribor
Reemplaza: Mercruiser 99746A8, A17
Marine Power 611447
Para mayoría de motores 4.3L (262 CID) V-6
Suministrado con kit de montaje
Usar con:
Kit montaje: 18-8533



18-1953 HG3
18-1953S
MER860246A15 OEM
COLECTOR
Babor & Estribor
Suministrado con kit de montaje
Reemplaza: Mercruiser 87114A19, 86024A10, 860246A15, 860246A3, 860246A7, 860246A9, 860336A2, 860337A2, 87114A19, 87114A30
Marine Power 0994-100
Para mayoría de bloques pequeños Mercruiser(GM) con codo central
Suministrado con juntas
Usar con: Kit de montaje: 18-8520



18-1954-1*
COLECTOR
Suministrado con kit de montaje
Reemplaza: Mercruiser 95862A5
Marine Power 0993-000
Para mayoría de últimos modelos 2.5L 153 CID & 3.0L 181 CID con carburador Rochester 5 TORNILLOS (1983-89)
Usar con:
Junta colector escape: 18-1204-1
Tapa lateral: 18-4009

*** PARA MODELOS ESPECÍFICOS VER APLICACIÓN EN PÁGINAS 125-128**

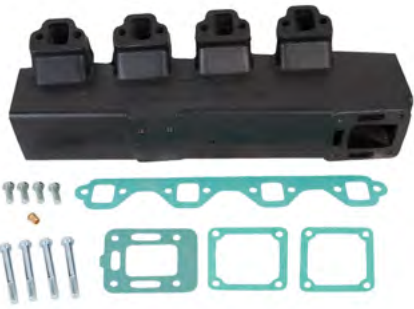

18-1958-1*
COLECTOR
 Reemplaza: 65604A4, A12 LADO BABOR
 Para mayoría de bloques pequeños Mercruiser (Ford) V-8
 Suministrado con kit montaje
 Usar con:
 Kit montaje: 18-8509



18-1955-1*
COLECTOR
 Nuevo tipo
 Suministrado con kit montaje
 Reemplaza: 96705A1
 Para mayoría de Modelos 3.0L 181 CID con carburador Rochester
 5 TORNILLOS y 2.5L, 153CID (1968-82)
 Usar con:
 Junta colector escape: 18-1203
 Tapa lateral: 18-4009



18-1956 HGE
18-1956S
MER860235A03-OEM
COLECTOR
 Suministrado con kit de montaje
 Reemplaza: Mercruiser 860235A04, 99798A3, 99798A9, 99798A16,
 99798A18, 806867A8
 Marine Power 600333
 Para 2.5 & 3.0L (1983-89)



18-1957 HGE
18-1957S
COLECTOR
 Babor & Estribor
 Reemplaza: Mercruiser 89011A8,
 807078A6
 Marine Power 0991-1000
 Para mayoría bloques grandes Mercruiser (GM) V-8
 Usar con:
 Colector escape: 18-0418
 Kit de montaje: 18-8532



18-1960S
COLECTOR
 Reemplaza: 58759A10, A14
 Para mayoría Mercruiser (GM) en línea 6 Cil.
 Suministrado con kit de montaje
 Usar con:
 Kit de montaje: 18-8531



18-1962-1*
COLECTOR
 Estribor
 Reemplaza: 65603A4, 65603A12
 Para mayoría de bloques pequeños Mercruiser (Ford)
 V-8
 Suministrado con kit de montaje
 Usar con:
 kit de montaje: 18-8509

* PARA MODELOS ESPECÍFICOS VER APLICACIÓN EN PÁGINAS 125-128



MER864309T02
CODO MODELO CORTO
 Reemplaza: 864309T02
 Altura: 17 cm.



18-1966-1 HGE

18-1966-1S

COLECTOR

Reemplaza: 806867A2, 806867A3, 806867A8, 806867A9, 806867A12, 816329A3, 860235A03, 99798A18

Para: 3.0L/LX (1990 & post); Motores Marine Power Model E181S



18-1843 HGE

18-1843S

COLECTOR ESCAPE

Reemplaza: 865735A02, 865049T01, 864308T01

Para: 305, 350, 377, 5.0L, 5.7L, 6.2L(2002 y post)

Usar con:

Junta colector: 18-2949

Junta codo: 18-0720, 18-0721 o 18-0722

Codo: 18-1845

18-1842 HGE

18-1842S

COLECTOR ESCAPE

Reemplaza: 864612T01. Para: Alpha Bravo (para 2002 y posteriores sin catalizador). Usar con juntas 18-0720, 18-0721 y 18-0722



18-1999 HGE

18-1999S

CODO

Reemplaza: Barr 20-0082

Para: 3" D.I. manguera escape.

Suministra con kit de montaje abierto 18-4364

Usar con:

Colector: 18-1997-1 o 18-1998-1 o 18-1898

Junta codo: 18-2854-1 abierto o 18-0476-1 cerrado

kit de montaje: 18-4364 abierto o 18-8535 cerrado



18-19702

CODO

Reemplaza: Mercuriser 98504A3, 98503A2, 95755A2

Marine Power 0992-115

Para V-6 & V-8 aplicaciones, 15° (Codo 3" D.E) Suministrado con 18-0897 y tapones de bronce

Usar con:

Colector: 18-1952-1, 18-1953-2, 18-1957-1

Junta codo: 18-0897 restrictor, 18-2849-1 abierto, 18-0672 cerrado

kit de montaje: 18-8529



18-1971 HGE

18-1971S

CODO

Reemplaza: Mercuriser 76351A2, 76351A1, 76351A04, 60426A1, 49964A1, 49964A2

Marine Power 0993-001

Para primeros modelos mercuriser Mercuriser 140 HP (4 cil) aplicaciones

Reemplaza: Barr MC20-60426P

Usar con:

Colector: 18-1960-1, 18-1958-1, 18-1950-1

Junta codo: 18-2833

kit de montaje: 18-4362



18-1992-1

ADAPTADOR ESCAPE

Para 3" D.I. manguera escape

(Como usado en kit conversión colector escape 18-1987) 80°

18-1972*

CODO

Reemplaza: 76325A2

Para últimos modelos 120, 140 HP aplicaciones Mercuriser

Usar con:

Colector: 18-1955-1, 18-1954-1,

18-1956-2, 18-1901

Junta codo: 18-2833

Kit montaje: 18-8552



18-1973*

CODO

Reemplaza: 39920, 39920A1, 55538A2

Para mayoría de primeros modelos 120 HP Aplic. Mercuriser aplicaciones



18-1991

CODO ADAPTADOR

Para uso con manguera escape 3" D.I.

Usar con:

Codo colector: 18-1999

30°

18-1978

CODO

Reemplaza: 76771A3, A2

V-8 Sólo aplicaciones intraborda

Usar con:

Colector: 18-1950-1, 18-1951-1,

18-1958-1, 18-1962-1

Junta codo: 18-2833

Kit de montaje: 18-4362



18-1905

CODO

Reemplaza: 90880

Mercuriser 4 Cilindro 224cu. in. 3.7L (Modelos: 165, 170, 180, 190).

Usar con:

Colector: Mercuriser 99908

Junta montaje codo escape: 18-0113-1

Kit de montaje: 18-8500

* PARA MODELOS ESPECÍFICOS VER APLICACIÓN EN PÁGINAS 473-476



18-1937 HGE
18-1937S

CODO

Reemplaza: 98562A6

Mercruiser 4 Cilindro 224cu. in. 3.7L (Modelos: 165, 170, 180, 190).

Usar con:

Junta montaje codo escape: 18-0881-1
Kit montaje: 18-8530



18-1974-1*
CODO

Reemplaza: 98502A2

Para aplicaciones V-6 & V-8 0° (Codo 3° D.E.)
Suministrado con junta 18-0897 y tapón bronce



18-1976 HGE
18-1976S

MER807988A03 Original
CODO

Reemplaza: Mercruiser 44354A3, 44354A9, 44354A10, 44354A13, 807914A1, 807988A2, 807988A03

Marine Power 0992-400

Para mayoría de aplicaciones Mercruiser V-6 & V-8 7° (Codo 4° D.E.) suministrado con 18-0897, 18-4263 & 18-4258

Usar con:

Colector: 18-1952-1, 18-1953-2, 18-1957-1
Junta codo: 18-0897 restrictor,
18-2849-1 abierto, 18-0672 cerrado
Kit montaje: 18-8505



18-1845 HGE
18-1845S

CODO ESCAPE

Reemplaza: 864591T02

Para: 2004 & sup V6 & V8(305, 350, 377) SN 0W310000 & sup, 2002 & sup V8(350 & 377) SN 0M317000 & sup

Usar con:

colector: 18-1843
Juntas codo: 18-0720, 18-0721 o 18-0722



18-1907 HGE
18-1907S

CODO

Reemplaza: Barr 20-0102, Indmar 53-2009 y 53-2018

Barr, Indmar Ford bloques pequeños V8 302-351cu. in • Usar con 3" manguera.

Usar con:

Colector: 18-1997-1, 18-1998-1
Junta codo: 18-2854-1 abierto o 18-0476-1 cerrado
Kit de montaje:
18-4364 abierto o 18-8535 cerrado



18-1939
CODO

Reemplaza: Barr 20-0100, Marine Power 0992-593

Barr, Indmar y Marine Power Ford bloques pequeños V8 302-351cu. in. GM bloques pequeños V8 305-350cu. in., GM bloque grande V8 454cu in. • Usar con 3 1/2" mang.

Usar con:

Colector: 18-1997-1, 18-1998-1, 18-1898
Junta codo: 18-2854-1 abierto
ó 18-0476-1 cerrado
Kit de montaje:
18-4364 abierto o 18-8535 cerrado



18-1975 HGE
18-1975S

CODO

Reemplaza: Mercruiser 12076A1, 12076A2, 95864A2

Marine Power 6000-33A

Para último modelo Mercruiser 4 cil.

Usar con:

Colector: 18-1955-1, 18-1954-1,
18-1956-2, 18-1901
Junta codo: 18-2833
Kit de montaje: 18-8551
Manguito: 18-2748

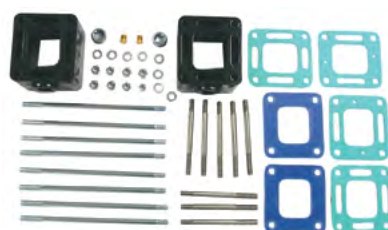

18-1908K
KIT ESP.COLECTOR/CODO

Reemplaza: 807476A6, 93320A2,

93320A3, 93320A5, 93320A6, 93320A13

Alpha/Bravo/Gen+/GenIV GM bloque pequeño V-8 305, 350, 4.3L, 454, 5.0, 5.7L, 502, 7.4L, 8.2L, (3° kit Riser)
Completo con tornillería de montaje. Codo central 3"

Usar con:

Colector: 18-1952-1, 18-1953-2, 18-1957-1
3"



18-1906
ESPACIADOR ESCAPE

Reemplaza: 61851A1

3" espaciador para 18-1950, 18-1951,
18-1958-1 & 18-1962-1 escapes

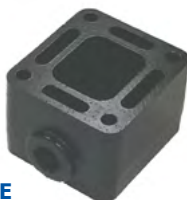

18-19081 HGE
18-19081S

ESPACIADOR CODO
COLECTOR - 3"

Reemplaza: 93320

Mercruiser GM V6 229 y 262cu.in. (Modelos: 185 and 205), bloques pequeños GM V8 305-350cu.in. (Modelos: 200, 228, 230, 260 y 898), bloque grande GM V8 454cu.in. (Modelos: 330, 340 y 7.4L)

Usar con:

Colector: 18-1952-1, 18-1953-2, 18-1957-1



18-1985
ESPACIADOR COLECTOR - 6"

Reemplaza: Mercruiser 93322

Marine Power 612011

Para: 229 y 262 V6, 305-350 bloq. pequeño V8, 454 Bloque grande V8

Usar con:

Colector: 18-1952-1,
18-1957-1, 18-1953-2



18-1949
ESPACIADOR COLECTOR

Espaciador 3" para Barr, Indmar y Marine Power Ford bloque pequeño V8 302-351cu.in., GM bloque pequeño V8 305-350cu.in., GM bloque grande V8 454cu.in.

Usar con:

Colector: 18-1998-1, 18-1997-1 y 18-1898



18-1990
JUNTA TAPA ESCAPE

Reemplaza: 48045, 54870, 73813, 73813A1, 73813F1



18-5021
JUNTA TAPA ESCAPE
Reemplaza: Mercruiser 805629
Usar con:
Colector: 18-1954-1,
18-1955-1, 18-1956-2



18-1995
TAPA COLECTOR
Reemplaza: 47638, 47638A1
GM 4 cil. 153 cu. in. Para modelo 110/120 acopla carb. parte posterior motor



18-4008
JUNTA TAPA ESCAPE
Reemplaza: 60207
Usar con:
Codo: 18-1971, 18-1978



18-4009
TAPA LATERAL COLECTOR
Reemplaza: 52999, 60252, 60252A2
Usar con:
Colector: 18-1960-1, 18-1958-1, 18-1950-1, 18-1951-1
Junta tapa lateral: 18-2832-1
Kit de montaje: 18-8512

TAPONES



Ref. #	Reemplaza	Tamaño rosca	Descripción
18-4257	—	1/4"	Tapón acero negro
18-4263	22-32802, 22-328022, 22-328021, 22-841908, 22-30139, F700633, F15810151,	1/8" - 27 NPT	Tapones
18-4264	22-32803, 22-87543, F15880010	3/8" - 18 NPT	Tapones
18-4265	22-428611, 22-42861, 22-861187	3/4" - 14 NPT	Tapones (bronce hexagonal)
18-8111 ①	22-36392	1/4" - 18 NPT	Tapones
18-4258	22-33198A1, 22-41622	3/4" - 14 NPT	Tapones (Acero inox cuadrado)

56507 Selladora de Teflon® recomendada para las estrias de la rosca



TORNILLOS RISE

Ref #	Reemplaza	Tamaño Rosca	Descripción
18-8410	10-43749	3/8"-16 x 5 3/4"	Usar sin filtro Aceite remoto
18-8411	10-44387	3/8"-16 x 6 3/4"	Usar sin filtro Aceite remoto



18-4362
KIT DE MONTAJE CODO ESCAPE
Reemplaza: Barr MC20-60426P
Usar con:
Codo: 18-1971



18-4363
KIT DE MONTAJE CODO ESCAPE
Reemplaza: Barr FM-1-83-P
Usar con:
Colector: 18-1998-1



18-4364 (Abierto)
KIT MONTAJE CODO ESCAPE
Reemplaza:
Barr 20-0082-P
Usar con:
Codo: 18-1999, 18-1907, 18-1939



18-8500
KIT DE MONTAJE CODO ESCAPE
Mercruiser 4 Cilindro 224cu.in. 3.7L (Modelos: 165, 170, 180, 190)
Usar con:
Codo/Depósito: 18-1905



18-8505
KIT DE MONTAJE CODO ESCAPE
Mercruiser GM V6 229 y 262cu.in. (Modelos 185 y 205), bloques pequeños GM V8 305-350cu.in. (Modelos: 200, 228, 230, 260, 898), GM Bloque grande V8 454cu.in. (Modelos: 330, 340 y 7.4L)
Usar con:
Codo: 18-1976-2



18-8508
KIT DE MONTAJE COLECTOR ESCAPE
Mercruiser GM 4 Cilindro 153cu.in. (Primeros modelos 110/120), GM En línea Cilindro 250cu.in. (Modelo: 160)
Usar con:
Codo: 18-1973

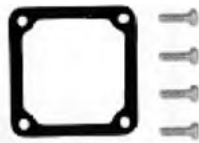

18-8512
KIT DE MONTAJE CODO ESCAPE
Mercruiser GM 4 Cilindro 181cu.in. (Modelos: 120,140, 2.5L,3.0L), GM En línea 6 Cilindro 250-292cu.in. (Modelos: 165 y 200), bloques pequeños Ford V8 302-351cu.in. (Modelos: 215,225,233, 255,888), bloques pequeños GM V8 305, 350cu. in. (Modelos: 198,228,898)
Usar con:
Tapa lateral: 18-4009

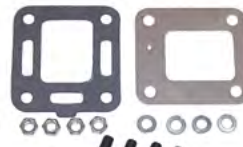

18-8514
KIT DE MONTAJE CODO ESCAPE
Mercruiser Ford bloques pequeños V8 302-351cu.in. (Modelos: 215, 225, 233, 255, 888), bloques pequeños GM V8 305-351cu.in. (Modelos: 198,228,898)
Usar con:
Codo: 18-1971 & 18-1978
(No para agua dulce/Sistema de refrigeración cerrado)



18-8520
KIT MONTAJE COLECTOR ESCAPE
Mercruiser bloque pequeño GM V8 305-350cu.in. (Modelos: 198, 200, 228, 230, 260, 898)
Usar con:
Colector: 18-1950-1, 18-1951-1, 18-1953-2

① Este producto es precio por pieza. Para envasado añadir -9 a la referencia



18-8529
KIT DE MONTAJE
CODO ESCAPE
Mercuriser GM V6 229 y 262cu. in. (Modelos 185 y 205), GM bloques pequeños V8 305-350cu. in. (Modelos: 200, 228, 230, 260, 898), GM bloques grandes V8 454 cu.in. (Modelos: 330, 340 and 7.4L)
Usar con: Codo: 18-1970-1



18-8530
KIT DE MONTAJE CODO ESCAPE
Mercuriser 4 Cilindro 224cu.in. 3.7L (Modelos: 165, 170, 180, 190)
Usar con:
Codo/Depósito: 18-1937



18-8531
KIT DE MONTAJE COLECTOR ESCAPE
Mercuriser GM Inline 6 Cilindro 250cu.in. (Modelos: 165 and 200)
Usar con :
Colector: 18-1960-1



18-8532
Mercuriser GM bloque grande V8 454cu. in. (Modelos: 330, 340 y 7.4L)
Usar con:
Colector: 18-1957-1



18-8533
KIT DE MONTAJE COLECTOR ESCAPE
Mercuriser GM V6 229 y 262 cu. in. (Modelos 185 y 205)
Usar con:
Colector: 18-1952-1

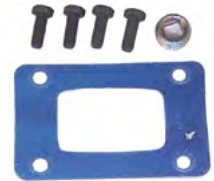

18-8535 (cerrado)
KIT DE MONTAJE
CODO ESCAPE
Barr, Indmar y Marine Power Ford bloque pequeño V8 302-351cu.in., GM bloque pequeño V8 305-350cu.in., GM bloque grande V8 454cu.in.
Usar con:
Codo: 18-1939, 18-1999, y 18-1907



18-8536
KIT DE MONTAJE CODO ESCAPE
Barr, Indmar y Marine Power GM bloque pequeño V8 305-350cu.in.
Usar con:
Colector: 18-1997-1



18-8538
KIT MONTAJE COLECTOR ESCAPE
Barr y Indmar Ford bloque pequeña V8 302-351cu.in.
Usar con:
Colector: 18-1998-1

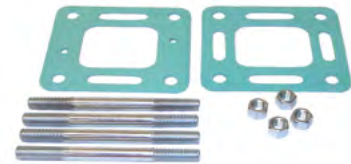

18-8554
KIT MONTAJE CODO ESCAPE
Para: 229 y 262 ci V6, 305 y 350 SB V8, 454 bloque grande V8.
Usar con:
Kit codo: 18-1908K y 18-1908 Espaciador
Codo: 18-1970-1
Colector: 18-1952-1, 18-1953-2 & 18-1957-1

9 1/2" tornillos

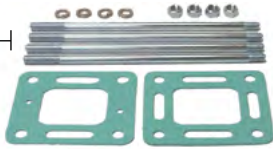

18-8555
KIT MONTAJE CODO ESCAPE
Para: 229 y 262 ci V6, 305 y 350 SB V8, 454 bloque grande V8.
Usar con:
Kit codo: 18-1908K y 18-1908 Espaciador
Codo: 18-1976-2
Colector: 18-1952-1, 18-1953-2 & 18-1957-1



18-8556
KIT DE MONTAJE CODO ESCAPE
Para: 229 y 262 ci V6, 305 y 350 SB V8, 454 bloque grande V8. Usado para montar espaciador 18-1985 a 18-1953-2, 18-1957-1 y 18-1952-1 colector

KITS TORNILLERÍA

Ref #	Para
18-8548	18-1950-1 & 18-1951-1 colector
18-8549	18-1955-1 colector
18-8551	18-1975-1 codo escape





















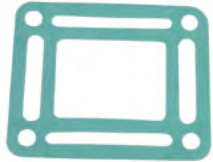

18-0183-1
JUNTA COLECTOR ESCAPE
Reemplaza: Mercuriser 27-73866, 27-54566 Volvo 3853742, 3852455, OMC 908717
Usar con:
Colector: 18-1962-1, 18-1938, 18-1998-1, 18-1996, 18-1979



18-0353
JUNTA MONTAJE CARBURADOR
Reemplaza: 27-58764
Usar con:
Colector: 18-1960-1



18-0418
JUNTA COLECTOR ESCAPE
Reemplaza: 27-46820
Usar con :
Colector: 18-1957-1, 18-1982, 18-1929, 18-1933, 18-1898

 <p>18-0476-1 JUNTA CODO Barr, Indmar & Marine Power Ford bloque pequeño V8 302-351cu.in. Usar con: Codos: 18-1939, 18-1999, 18-1907</p>	<p>Pack de 2</p>  <p>18-0672 18-0672-9① JUNTA CODO ESCAPE Reemplaza: 27-860231,8637251, 27-41811, 27-863725 Usar con: Codo: 18-1970-1, 18-1976-2</p>	 <p>18-0881-1 JUNTA CODO ESCAPE Reemplaza: 27-18272, 27-97863 Incluido en kit de montaje 18-8530. Usar con: Codo: 18-1937</p>	
<p>Pack. de 2</p>  <p>18-0885-1 18-0885-9 ① JUNTA CODO ESCAPE Reemplaza: 27-48042</p>	 <p>18-0897 (Restrictor)  MER278637240 Original JUNTA CODO Reemplaza: 27-41813, 27-860233, 27-863724 Usar con: Codos: 18-1976-2, 18-1970-1</p>	<p>Pack. de 2</p>  <p>18-1204-1 18-1204-1-9 ① JUNTA COLECTOR ESCAPE Reemplaza: 27-96429</p>	<p>Pack. de 2</p>  <p>18-1210 18-1210-9 ① JUNTA TAPA LATERAL Reemplaza: 27-39923</p>
<p>Pack de 2</p>  <p>18-2819-1 18-2819-9 ① JUNTA CODO ESCAPE Reemplaza: 27-39915</p>	 <p>18-2830-1 JUNTA COLECTOR ESCAPE 6 cil. Reemplaza: 27-46401</p>	<p>Pack de 2</p>  <p>18-2832-1 18-2832-1-9① JUNTA TAPA LATERAL Reemplaza: 27-480431 Usar con: Colector: 18-1951-1, 18-1950-1, 18-1954-1, 18-1958-1, 18-1955-1, 18-1956-2, 18-1960-1, 18-1962-1 Tapa lateral: 18-4009</p>	<p>Pack de 2</p>  <p>18-2833 18-2833-9① JUNTA CODO ESCAPE Reemplaza: 27-997772</p>
<p>Pack de 2</p>  <p>18-2849-1 (abierto) 18-2849-9-1① JUNTA CODO ESCAPE Reemplaza: 27-87105-1, 27-818832, 27-863726 Usar con: Codos: 18-1976-2, 18-1970-1</p>	<p>Pack. de 2</p>  <p>18-2854-1 (abierto) 18-2854-9① JUNTA CODO ESCAPE Reemplaza: Barr 01-0107 Usar como : Codos: 18-1999, 18-1939, 18-1907</p>	 <p>18-2896-1 JUNTA COLECTOR ESCAPE Reemplaza: 27-52546, 27-32816 GM 4 cil. 153 cu. in. Para modelo 110/120 acople motor parte posterior motor</p>	 <p>18-2909 18-2909-9① JUNTA COLECTOR ESCAPE Para: GM V-6 Usar con: Colector: 18-1952-1</p>
 <p>18-2912-1 JUNTA COLECTOR ESCAPE Reemplaza: 27-53354</p>	<p>Pack de 2</p>  <p>18-2949 18-2949-9② JUNTA COLECTOR ESCAPE Reemplaza: Mercruiser 27-33395 Barr CHV-47-000 GM 5.0L & 5.7L Usar con: Colector: 18-1997-1, 18-1950-1, 18-1951-1</p>	 <p>18-0603 KIT JUNTAS COLECTOR ESCAPE Para: motores Ford 302/351 CID Para usar con 18-1998-1</p>	 <p>18-0604 KIT JUNTAS COLECTOR ESCAPE Para: motores GM 305/350 CID Para usar con 18-1997-1</p>

① Precio por envase

Características

- Fabricado para superar la calidad del original.
- Filtro alto rendimiento
- Comprobado y aprobado.
- Con válvula by-pass.



FILTRO ACEITE

- ① No usar en motores V-6 equipados con kit de filtro de aceite remoto
- * Envasado en Display

Ref #	O.E. #	Aplicación
18-7824 187824E	54111, 14957, 32716, 35-802885Q, 35-866340K01, 35-866340Q03, 35-866340Q02, 35-866340K01, 35-866340Q, 52731A1, 52731, 52022, 32717, 14957	Motores GM ① (Filtro corto)
18-7871	35-805809, 35-805809T	D7.3L Diesel
18-7875*	60565, 35-802886Q	Motores Ford (Filtro largo)
18-7876*	52731, 35-16595T, 35-866340Q03, 35-866340Q02, 32-802885Q, 14957, 54111, 52731A1, 52022, 32717, 32716	Motores GM (Filtro largo)
18-7878-1*	803470, 803470Q, 46692, 38463	Motores 60 & 80 HP (Renault) (Filtro corto)
18-7879-1*	41815, 35-802884Q, 35-883702Q, K	Motores GM V-6

CARTER DE ACEITE Y JUNTAS



Ref No.	OE	OE No.	Aplicación
18-0612	Mercuriser	809910, 14259	Retén trasero de 1 sola pieza; GM Bloque peq V8 (Varilla mano derecha)
18-0613	Mercuriser	93476	Retén trasero de 2 piezas; GM bloque peq. V8 (Varilla mano derecha)
18-0614	Mercuriser	845668T, 850458, 811549	Retén trasero de 1 pieza; GM bloque grande V8 (Varilla mano derecha)
18-0615	Mercuriser	93477T, 93477, 14760, 75639	Retén trasero de 2 piezas; GM bloque grande V8 (Varilla mano derecha)
18-0616	Mercuriser	14244T, 14244	Retén trasero de 1 sola pieza; GM V6 (Varilla mano derecha)

Tornillo drenaje: M12 - 1.75

CULATAS

Las culatas son nuevas y montadas con válvulas reforzadas, asientos de válvula de acero templado, muelles de válvulas, semi-conos, y retenes.
Todas las culatas GM utilizan espárragos de alto rendimiento en lugar de los originales.



18-4485HP

CULATA

Reemplaza: 938-883490R1, 938-883490, 938-883490R50, 938-884741R
938-884741R50

Para: 5.7L V-8 GM (1987-95) con 12 pernos en el colector de admisión.
Para tapa de válvula con tornillos en el centro



18-4486

CULATA

Reemplaza: 938-883297 1, 938-803860T

Para: 5.7L V-8 GM Vortec (1996-sup) con 8 pernos en el colector de admisión. Para tapa de válvula con tornillos en el perímetro.



18-4486HP

CULATA

Para: Vortec GM bloques pequeños 5.7L alto rendimiento
Completamente ensamblado con carreras y cámaras de combustión revisadas. Añade 30hp. sin modificaciones



MER 8M115135

CULATA

Para: 3.0L. Reemplaza: 8M0115135



18-4501HP

CULATA

Para: Vortec GM bloque pequeño 5.0L
Completamente ensamblado con carreras y cámaras de combustión revisadas. Añade 30hp. sin modificaciones





18-4492
CONJUNTO DE BALANCINES
Reemplaza: 35329, F3746241, FI1100014, FI1100495
Para: Motores MCM/MIE Gm V6 & V8(283, 305 & 350 cid)



18-7508
BOMBA DIRECCIÓN
Reemplaza: 16792A39, 16792A33



18-8227
POLEA BOMBA CON DIRECCIÓN ASISTIDA
Reemplaza: 73873A1, 73873
Para: Sterndrives con correa



18-8297
POLEA BOMBA DIRECCIÓN
Reemplaza: 861578
Para: Sterndrives con correa serpentin



18-1400
LEVA HIDRÁULICA
Reemplaza: 17340, 17340T
GM 4.3L/últimos V-6 /5.0L/5.7L



18-1401
LEVA HIDRÁULICA
Reemplaza: 56153, F724102
Ford 302/351
Ford 5.0L & 5.8L



18-1402
LEVA HIDRÁULICA
Reemplaza: 72638, 34282, 35583, 46472, 46744, 49117, F2769931, F5232670, FI1100349, FI1100399, FI1100862, FI1100954, FI1101222
GM 2.5L/120
Para: Mercruiser 140 (S/N 2508261-6229717), 140/3.0L (S/N 6229718-sup), 3.0L/3.0LX (S/N C856559-sup)

PISTONES



Todos los pistones se suministran completos, con aros, bulón y cierres.

AROS

STD	REEMPLAZA
18-3928	39-74381A1, 39-75422
18-3937	39-17464, 39-65153, 39-67123, 39-34988, F328506, F3892364, FI1100386, FI1100692, FI1101321
18-3942	39-67132, 39-67119, 39-58096, 39-34479
18-3944	39-75609, FI1101057
.020	
18-3939	39-66217, 39-97125, 39-48344, FI1100387, FI1100783, FI1101134
.030	
18-3938	39-17465, 39-67126, 39-48345, FI1100694, FI1101322, F328516

PISTONES

STD	REEMPLAZA
18-4180	736-2343, 733-66217, 733-2278
18-4161	733-3819, 733-803850T, 733-4028, 24-38191, FI1100779, FI1100780
18-4109	778-9441A3, 759-80661A7, 759-80661A3, 759-8312A2, 759-831210, 759-661010, 759-592010, 778-9015A2
18-4173	735-6370, 735-9686, 735-808674, 735-850097, 735-808674A1, 735-808661, 735-9703, 735-6370, FI1101184, FI1101318, FI1101334, 833232E
.020	
18-4160	733-3818, 733-38181, FI1100781
18-4189	737-6523, 737-6523, 737-879194035, FI1101101
.030	
18-4134	778-9441A5, 759-80661A8, 759-806661A5, 759-9015A4, 759-8312A6, 759-831212, 759-661012, 759-592012
18-4164	735-6371, 735-9687, 735-850098, 735-9431, 735-9704, FI1101185, FI1101320, FI1101336
18-4178	735-9715, 735-97151, 735-97151T, FI1101317
18-4191	733-3819, 733-38191, 733-803850T, 733-4028, FI1100779, FI1100780

APLICACIÓN PISTÓN/AROS

Litro	Modelo	Nota	CID	# Cil	tiempos	Año	Número serie	PISTONES		Aros			Cant. motor.
								Std.	Nota	0.02	0.03	Nota	
7.4L	7.4L BRAVO		454	8	4	1988-1991	B771113 - D603117	-		-	-	-	8
7.4L	7.4L BRAVO I GEN V / 7.4L BRAVO II GEN V		454	8	4	1992-1995	D603118 - F800699	-	1	-	-	-	8
7.4L	7.4L BRAVO I GEN V / 7.4L BRAVO II GEN V		454	8	4	1992-1996	D603118 - F800699	-	2	-	-	-	8
7.4L	7.4L BRAVO III GEN V		454	8	4	1992-1995	D603118 - F800699	-	3	-	-	-	8
7.4L	7.4L BRAVO III GEN V		454	8	4	1992-1996	D603118 - F800699	-	4	-	-	-	8
7.4L	7.4L BRAVO GEN VI		454	8	4	1996-1997	F800700 - K999999	-		-	-	-	8
7.4L	7.4L EFI GEN VI / 7.4L MIE GEN VI / 7.4L GEN VI MIE		454	8	4	1996-1997	F874815 - K999999	-		-	-	-	8
7.4L	7.4L MIE WHURTH		454	8	4	1988-1992	B788366 - D715493	-		-	-	-	8
7.4L	7.4L MIE WHURTH		454	8	4		C391564 - & sup	-		18-4189		18-3940	8
7.4L	7.4L MIE GEN V		454	8	4	1992-1995	D715494 - F820141	-	5	-	-	-	8
7.4L	7.4L MIE GEN V		454	8	4	1992-1996	D715494 - F820141	-	5	-	-	-	8
7.4L	7.4L MIE GEN VI		454	8	4	1996-1997	F820142 - K999999	-		-	-	-	8
7.4L	7.4L MPI GEN VI		454	8	4	1998-2001	L010003 - M024330	-		-	-	-	8
7.4L	7.4L MPI GEN V / 7.4L MIE GEN V		454	8	4	1995-1996	F563052 - F820103	-		-	-	-	8
7.4L	7.4L MPI GEN VI / 7.4L MIE GEN VI / 7.4LH GEN VI		454	8	4	1996-1997	F820104 - K999999	-		-	-	-	8
7.4L	7.4L MPI L-29 GEN VI / 7.4L MIE L-29 GEN VI		454	8	4	1998-2001	L020006 - M025999	-		-	-	-	8
7.4L	7.4LX BRAVO GEN VI / 7.4L BRAVO EFI		454	8	4	1996-1997	F802000 - K999999	-		-	-	-	8
7.4L	7.4LX BRAVO GEN V / 7.4L MPI GEN V		454	8	4	1996	F802010 - F801999	-		-	-	-	8
7.4L	7.4LX BRAVO GEN VI / 7.4L MPI GEN VI		454	8	4	1996-1997	F802000 - K999999	-		-	-	-	8
7.9L	390		482	8	4	1969-1970	2781129 - 2825059	-		-	-	-	8
7.9L	460 TRS		482	8	4	1983-1986	4179554 - 6181046	-		-	-	-	8
8.1L	496		482	8	4	2001-2010	M025000 & SUP	-	9	-	-	-	8
8.1L	496		496	8	4	2001-2010	M025000 & SUP	-	10	-	-	-	8
8.2L	465		502	8	4	1990-1992	C849992 - D725646	-		-	-	-	8
8.2L	465 GEN V		502	8	4	1992-1994	D725647 - F213244	-		-	-	-	8
8.2L	500 GEN V		502	8	4	1994-1996	F213293 - F745159	-		-	-	-	8
8.2L	500 GEN VI		502	8	4	1997-1999	K745195 - L601036	-		-	-	-	8
8.2L	500 EFI		502	8	4	1999-2005	L001477 - M907127	-		-	-	-	8
8.2L	502 MAG BRAVO		502	8	4	1990-1992	C878221 - D824588	-		-	-	-	8
8.2L	502 MAG BRAVO GEN V		502	8	4	1992-1993	D824589 - F114528	-		-	-	-	8
8.2L	502 MAG EFI		502	8	4	1993-1996	D640650 - F802599	-		-	-	-	8
8.2L	502 MAG MPI GEN VI		502	8	4	1996-2001	F802600 - M024999	-		-	-	-	8
8.2L	525 EFI		502	8	4	2003-2010	M900146 & SUP	-		-	-	-	8
8.2L	575 Sci		502	8	4	2001-2005	L306696 - M950526	-		-	-	-	8
8.2L	600 SC		502	8	4	1991-1992	D456489 - D456768	-		-	-	-	8
8.2L	600 SC GEN V		502	8	4	1992-1996	D725676 - F877642	-		-	-	-	8
8.2L	600 SC GEN VI		502	8	4	1997-2000	K000227 - L601186	-		-	-	-	8
8.2L	8.2L MAG EC		502	8	4	2010	A350340 & SUP	-		-	-	-	8
8.2L	8.2L MIE / 8.2L EC		502	8	4	2010	A350802 & SUP	-		-	-	-	8
8.2L	8.2L MIE WHURTH		502	8	4	1990-1992	C878221 - D857199	-		-	-	-	8
8.2L	8.2L MIE GEN V		502	8	4	1993-1995	D857200 - F819619	-		-	-	-	8
8.2L	8.2L MPI GEN VI / 8.2L MIE GEN VI / 8.2LH GEN VI		502	8	4	1996-2001	F819620 - L674200	-		-	-	-	8
8.9L	500 BULLDOG		540	8	4	1990-2001	C577254 - M050281	-		-	-	-	8
8.9L	575		540	8	4	1986-1992	A677429 - D763716	-	7	-	-	18-3937 18-3939 18-3938	8

- (1) Aluminio fundido (Usar con Motor GM Código 1XW)
- (2) Aluminio fundido (Usar con motor GM Código 4XW)
- (3) Aluminio forjado (Usar con motor GM Código 3UB)
- (4) Aluminio fundido (Usar con motor GM Código 4XX)
- (5) Aluminio fundido (Usar con motor GM Código 2XY)
- (6) Aluminio fundido (Usar con motor GM Código 4XY)
- (7) Cabeza plana
- (8) Aluminio forjado, Cabeza rebajada
- (9) Estribor
- (10) Babor
- (11) .010 (25mm) tamaño
- N.L.A. N/O en original



COJINETE BIELA

Ref No.	talla	Reemplaza Mercruiser:
18-1148	Std.	68704A1, 23-853853, 23-853853A1, 23-853853002
18-1308	Std.	23-85701, 23-15961, 23-52221, 23-52270, F3910555, F3916351, F1100305, F1100570
18-1309	0.01	23-85704, 23-52224, 23-52273, 23-1596110, F1100381, F1100573
18-1327	Std.	23-11992, 23-11992001
18-1329	Std.	23-85677, 23-52242, 23-48351
18-1333	0.01	23-85691, 23-69887, 23-49171
18-1334	Std.	23-85726, 23-85726001, 23-49168, 23-69884, F1100980
18-1337	0.01	23-811858, 23-811858001
18-1341	0.02	23-85705, 23-1596120, 23-52225, 23-52274, F1100382

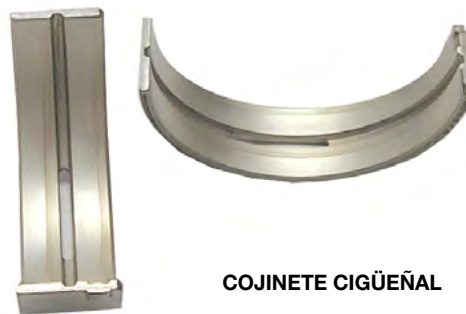

COJINETE CIGÜEÑAL

Ref No.	Para mot.	talla	Reemplaza Mercruiser:
18-1131	4	0.010	74313A4
18-1137	①	0.020	15103-A3
	①	Std.	23-801793
18-1320	①	0.010	23-801803
18-1317	①	Std.	23-818469, 23-818469001, 23-34464, 23-85669, 23-85715, 23-52261,



COJINETE LEVA

Ref No.	Para mot.	Reemplaza Mercruiser:
18-1305	1 ①	23-85684
18-1340	5 ①	23-67484

Se venden individualmente, 1 por biela

① Conjunto completo del motor







HP	Litro	Modelo	Nota	CID	# Cil	tiempos	Años	Número serie	COJINETE BIELA			COJINETE CIGÜEÑAL			
									Std.	0.01	0.02	Std.	0.01	0.02	COJINETE LEVA
		250		327	8	4	1968-1969	2314301 - 2639854	18-1308	18-1309	18-1341	-	-	-	-
5.7L		250		350	8	4	1977	4768000 - 4908849	18-1308	18-1309	18-1341	-	-	-	-
5.7L		255	GM	350	8	4	1975-1976	4175500 - 4767999	18-1308	18-1309	18-1341	-	-	-	-
5.7L		255 MIE		350	8	4	1975-1980	4175500 - 5907057	18-1308	-	-	-	-	-	-
5.7L		260	GM	350	8	4	1978-1987	4908850 - B773304	18-1308	18-1309	18-1341	-	-	-	-
5.7L		260 MIE		350	8	4	1981-1987	5907058 - B788151	18-1308	18-1309	18-1341	-	-	-	-
5.7L		260 / 5.7L	GM	350	8	4		B525982 & sup	18-1308	18-1309	18-1341	-	-	-	-
5.7L		260 / 5.7L	GM	350	8	4		B522506 & sup	18-1308	18-1309	18-1341	-	-	-	-
5.7L		270	GM	350	8	4	1969-1972	2851074 - 3077735	18-1308	18-1309	18-1341	-	-	-	-
5.7L		280	GM	350	8	4	1975-1976	4176250 - 4770199	18-1308	18-1309	18-1341	-	-	-	-
5.7L		300	GM	350	8	4	1985-1986	6668677 - B430367	18-1308	18-1309	18-1341	-	-	-	-
5.7L		320 EFI	GM	350	8	4	1987-1989	A543604 - C622418	18-1308	18-1309	18-1341	-	-	-	-
5.7L		320 EFI BRAVO	GM	350	8	4		B157603 & sup	18-1308	18-1309	18-1341	-	-	-	-
		325 GM			8	4		2278747 & sup	18-1334	18-1333	18-1332	-	-	-	-
		330 GM			8	4		4623115 & sup	18-1334	18-1333	18-1332	-	-	-	-
		330 W.B.W.	GM		8	4		6083045 & sup	18-1334	18-1333	18-1332	-	-	-	-
7.4L		340 / 7.4L	GM		8	4		5889914 & sup	18-1334	18-1333	18-1332	-	-	-	-
5.7L		350 MAG ALPHA		350	8	4	1986-1997	A635178 - K999999	18-1308	18-1309	18-1341	-	-	-	-
5.7L		350	GM	350	8	4		3780450 & sup	18-1334	18-1333	18-1332	-	-	-	-
5.7L		350 MAG / 350 ALPHA / 350 EFI / 350 GEN +		350	8	4	1996-1997	F800300 - K999999	18-1308	-	-	-	-	-	-
5.7L		350 MAG / 350 BRAVO / 350 MPI		350	8	4	1995	F415189 - F601999	18-1308	-	-	-	-	-	-
5.7L		350 MAG / 350 BRAVO / 350MPI / 350 GEN +		350	8	4	1996-1997	F602000 - K999999	18-1308	-	-	-	-	-	-
5.7L		350 MAG SKI		350	8	4	1994-1996	F215561 - F820706	18-1308	-	-	-	-	-	-
5.7L		350 MAG EFI SKI GEN +		350	8	4	1996-1997	F820707 - K999999	18-1308	-	-	-	-	-	-
5.7L		350 MAG MPI GEN +		350	8	4	1988-2010	L010019 & SUP	18-1308	-	-	-	-	-	-
5.7L		350 MAG MPI / 350 MAG MIE GEN +		350	8	4	1998-2007	L002008 - A089999	18-1308	-	-	-	-	-	-
5.7L		350MG / 350 MPI / 350 SKI		350	8	4	1995-1996	F350583 - F799999	18-1308	-	-	-	-	-	-
5.7L		350 MAG / 350 MPI / 350 SKI / 350 GEN +		350	8	4	1998-2007	L002600 - A089999	18-1308	-	-	-	-	-	-
5.7L		350 MAG SKI		350	8	4	1991-1997	D505450 - K999999	18-1308	-	-	-	-	-	-
5.7L		5.7L		350	8	4	1988-1997	4908850 - F600999	18-1308	-	-	-	-	-	-
5.7L		5.7L GEN +		350	8	4	1998-2010	L010037 & SUP	18-1308	-	-	-	-	-	-
5.7L		5.7L EFI		350	8	4	1995-1997	F225560 - K999999	18-1308	-	-	-	-	-	-
5.7L		5.7L EFI GEN +		350	8	4	1998-2001	L010035 - M2999999	18-1308	-	-	-	-	-	-
5.7L		5.7L EFI MIE GEN +		350	8	8	1997	K040300 - K999999	18-1308	-	-	-	-	-	-
5.7L		5.7L MIE		350	8	4	1988-1997	B788152 - K999999	18-1308	-	-	-	-	-	-
5.7L		5.7L MIE GEN +		350	8	4	1998-2010	L002003 & SUP	18-1308	-	-	-	-	-	-
5.7L		5.7L MPI / 5.7L MIE		350	8	4	2008-2010	A090000 & SUP	18-1308	-	-	-	-	-	-
5.7L		5.7L MPI SKI		350	8	4	2008-2010	A090000 & SUP	18-1308	-	-	-	-	-	-
5.7L		5.7L SKI		350	8	4	1985-1987	A338553 - K999999	18-1308	-	-	-	-	-	-
5.7L		5.7L SKI GEN +		350	8	4	1998-2010	L002005 & SUP	18-1308	-	-	-	-	-	-
5.7L		5.7LX		350	8	4	1996-1997	F601000 - F600999	18-1308	-	-	-	-	-	-
5.7L		5.7LX / 5.7LX BRAVO / 5.7LX EFI / 5.7LX GEN +		350	8	4	1996-1997	F800300 - K999999	18-1308	-	-	-	-	-	-
5.7L		5.7L EFI		350	8	4	1996-1997	F752400 - K999999	18-1308	-	-	-	-	-	-
5.7L		BLACK SCORPION SKI GEN +		350	8	4	1996-2006	F800000 - W689999	18-1308	-	-	-	-	-	-
5.7L		BLACK SCORPION SKI GEN +		350	8	4	2003-2007	W690000 - W698432	-	①	-	①	-	-	-
5.7L		SCORPION 350		350	8	4	2008-2010	W698433 & SUP	-	①	-	①	-	-	-
		233		351	8	4	1975-1977	4173000 - 4902304	-	-	-	-	-	-	-
		255	FORD	351	8	4	1973-1974	3258728 - 4175499	-	-	-	-	-	-	-
		TOURNEY SKI			8	4		D505450 & sup	18-1308	18-1309	18-1341	-	-	-	-
		370 TRS	GM		8	4		6721528 & sup	18-1334	18-1333	18-1332	-	-	-	-
		377 MAG		377	8	4	2008-2010	A3000000 & SUP	-	①	-	①	-	-	-
		377 SCORPION MCM		377	8	4	1999-2005	L416145 - M907201	-	①	-	①	-	-	-
		377 SCORPION SKI GEN +		377	8	4	1997-1998	K000656 - L600314	-	①	-	①	-	-	-
6.2L		MX 6.2L MPI		377	8	4	2000-2007	L680003 - A299999	-	①	-	①	-	-	-
6.2L		MX 6.2L MPI / MX 6.2L HORIZON		377	8	4	2002-2007	M3000000 - A299999	-	①	-	①	-	-	-
6.2L		MX 6.2L MPI / MX 6.2L HORIZON / MX 6.2L MIE		377	8	4	2002-2010	M3000000 & SUP	-	①	-	①	-	-	-
6.2L		MX 6.2L MPI / MX 6.2L MIE		377	8	4	2002-2010	M3000000 & SUP	-	①	-	①	-	-	-
6.2L		MX 6.2L BLACK SCORPION SKI		377	8	4	2002-2007	M3000000 - W698432	-	①	-	①	-	-	-
6.2L		SCORPION 377		377	8	4	2008-2010	W698433 & SUP	-	①	-	①	-	-	-
7.4L		325		454	8	4	1969-1972	2278747 - 3780449	-	-	-	-	-	-	-
7.4L		330		454	8	4	1977-1987	4623115 - B816540	-	-	-	-	-	-	-
7.4L		330 MIE		454	8	4	1977-1980	4623115 - 5889913	-	-	-	-	-	-	-
7.4L		340 MIE W/B-W		454	8	4	1981-1987	5889914 - B788365	-	-	-	-	-	-	-
7.4L		350 MIE		454	8	4	1974-1976	3780450 - 4623109	-	-	-	-	-	-	-
7.4L		370 TRS		454	8	4	1978-1987	4179554 - B714586	-	-	-	-	-	-	-
		390	GM		8	4		2781129 - 2825059	18-1334	18-1333	18-1332	-	-	-	-
7.4L		400 TRS		454	8	4	1980-1986	4179554 - B457644	-	-	-	-	-	-	-
7.4L		420	GM	454	8	4	1987-1989	A398941 - B622418	18-1334	18-1333	18-1332	-	-	-	-
7.4L		425	GM	454	8	4	1990-1992	B622419 - D725499	-	-	-	-	-	-	-
7.4L		425 GEN V		454	8	4	1992-1993	D725500 - D937011	-	-	-	-	-	-	-
7.4L		440 TRS		454	8	4	1983-1986	4179554 - B485220	-	-	-	-	-	-	-
7.4L		450 GEN V		454	8	4	1995-1996	F347100 - F347277	-	-	-	-	-	-	-
7.4L		454 MAG ALPHA	GM	454	8	4	1986-1988	A631894 - B785148	18-1334	18-1333	18-1332	-	-	-	-
7.4L		454 MAG BRAVO		454	8	4	1988-1992	B721206 - D805068	-	-	-	-	-	-	-
7.4L		454 MAG BRAVO	GM	454	8	4		B840126 & SUP	18-1334	18-1333	18-1332	-	-	-	-

HP	Litro	Modelo	Nota	CID	# Cil	tiempos	Año	Número serie	COJINETE BIELA			COJINETE CIGUENAL			COJINETE LEVA
									Std.	0.01	0.02	Std.	0.01	0.02	
7.4L	454	MAG BRAVO GEN V		454	8	4	1992-1996	D805069 - M801699	18-1334	18-1333	18-1332	-	-	-	-
7.4L	454	MAG BRAVO GEN VI		454	8	4	1996-1997	F801700 - K999999	-	-	-	-	-	-	-
7.4L	454	MAG EFI GEN V		454	8	4	1994-1996	F115700 - F802349	-	-	-	-	-	-	-
7.4L	454	MAG EFI SKI GEN V		454	8	4	1995-1996	F215800 - F820099	-	-	-	-	-	-	-
7.4L	454	MAG MPI GEN VI		454	8	4	1996-2001	F802350 - M024999	-	-	-	-	-	-	-
7.4L	454	MAG MPI / 454 MAG HORIZON / 454 MAG MIE		454	8	4	1998-2001	L002200 - L674000	-	-	-	-	-	-	-
7.4L	454	MAG MPI / 454 MAG SKI GEN VI		454	8	4	1996-1997	F820100 - K999999	-	-	-	-	-	-	-
7.4L	454	EFI		454	8	4		F115700 & SUP	18-1334	18-1333	18-1332	-	-	-	-
	502	MAG	GM		8	4		C878221 & sup	18-1334	18-1333	18-1332	-	-	-	-
	502	MAG BRAVO GEN V			8	4		D824589 & sup	18-1334	18-1333	18-1332	-	-	-	-
	502	MAG BRAVO GEN V			8	4		D840650 & sup	18-1334	18-1333	18-1332	-	-	-	-
	502	EFI			8	4		3108723 & sup	18-1336	-	-	-	-	-	-
	525	SC		454	8	4	1991-1992	D456000 - D725808	-	-	-	-	-	-	-
	525	SC GEN V		454	8	4	1992-1996	D763746 - F745215	-	-	-	-	-	-	-
	525	SC GEN V		454	8	4	1996-1999	F745260 - L415623	-	-	-	-	-	-	-
7.4L	7.4L	BRAVO		454	8	4	1988-1991	B771113 - D603117	-	-	-	-	-	-	-
7.4L	7.4L	BRAVO GEN V		454	8	4	1992-1996	D603118 - F800699	-	-	-	-	-	-	-
7.4L	7.4L	BRAVO GEN VI		454	8	4	1996-1997	F800700 - K299999	-	-	-	-	-	-	-
7.4L	7.4L	EFI / 7.4L MIE GEN VI		454	8	4	1996-1997	F874815 - K999999	-	-	-	-	-	-	-
7.4L	7.4L	MIE		454	8	4	1988-1992	B788366 - D715493	-	-	-	-	-	-	-
7.4L	7.4L	MIE GEN V		454	8	4	1992-1996	D715494 - F820141	-	-	-	-	-	-	-
7.4L	7.4L	LH / 7.4L MIE GEN VI		454	8	4	1996-1997	F820142 - K999999	-	-	-	-	-	-	-
7.4L	7.4L	MPI GEN V		454	8	4	1998-2001	L010003 - M024330	-	-	-	-	-	-	-
7.4L	7.4L	MPI GEN V / 7.4L MIE GEN V		454	8	4	1995-1996	F563052 - F820103	-	-	-	-	-	-	-
7.4L	7.4L	MPI GEN VI / 7.4L MIE GEN VI		454	8	4	1996-1997	F820104 - K999999	-	-	-	-	-	-	-
7.4L	7.4L	MPI GEN VI L29 / 7.4L MIE GEN VI L29		454	8	4	1998-2001	L002006 - M025999	-	-	-	-	-	-	-
7.4L	7.4L	LX BRAVO TBI GEN VI		454	8	4	1988-2001	F802000 - K999999	-	-	-	-	-	-	-
7.4L	7.4L	LX BRAVO MPI GEN V		454	8	4	1996	F602010 - F801999	-	-	-	-	-	-	-
7.4L	7.4L	LX BRAVO MPI GEN VI		454	8	4	1996-1997	F802000 - K999999	-	-	-	-	-	-	-
7.4L	7.4L	BRAVO	GM					D603118 & Sup	18-1334	18-1333	18-1332	-	-	-	-
7.4L	7.4L	BRAVO GEN V						C391564 & Sup	18-1334	18-1333	18-1332	-	-	-	-
7.4L	7.4L	W/HURTH						D715494 & Sup	18-1334	18-1333	18-1332	-	-	-	-
7.4L	7.4L	LHR GEN V						C878221 & Sup	18-1334	18-1333	18-1332	-	-	-	-
	390			482	8	4	1969-1970	2781129 - 2825059	-	-	-	-	-	-	-
	460	TRS		482	8	4	1983-1986	4179554 - 6181046	-	Ⓛ	Ⓛ	-	-	-	-
	496	MAG / 496 HO		496	8	4	2001-2010	M025000 & SUP	-	-	-	-	-	-	-
	8.1S	MPI / 8.1S MIE / 8.1S HO		496	8	4	2001-2010	M025000 & SUP	-	-	-	-	-	-	-
8.2L	465			502	8	4	1990-1992	C849992 - D725646	-	-	-	-	-	-	-
8.2L	465	GEN V		502	8	4	1992-1994	D725647 - F213244	-	-	-	-	-	-	-
8.2L	500	GEN V		502	8	4	1994-1996	F213293 - F745159	-	-	-	-	-	-	-
8.2L	500	GEN VI		502	8	4	1997-1999	K745195 - L601036	-	-	-	-	-	-	-
8.2L	500	EFI		502	8	4	1999-2000	L001477 - L306499	-	-	-	-	-	-	-
8.2L	500	EFI		502	8	4	2000-2005	L306500 - M907127	-	-	-	-	-	-	-
8.2L	502	MAG BRAVO		502	8	4	1990-1992	C876221 - D824588	-	-	-	-	-	-	-
8.2L	502	MAG BRAVO GEN V		502	8	4	1992-1993	D824589 - F114528	-	-	-	-	-	-	-
8.2L	502	MAG EFI		502	8	4	1993-1996	D840650 - F802599	-	-	-	-	-	-	-
8.2L	502	MAG MPI GEN VI		502	8	4	1996-2001	F802600 - M024999	-	-	-	-	-	-	-
8.2L	525	EFI		502	8	4	2003-2007	M900146 - M958499	-	-	-	-	-	-	-
8.2L	525	EFI		502	8	4	2007-2010	M958500 & SUP	-	-	-	-	-	-	-
8.2L	575	SCi		502	8	4	2007-2005	L306696 - M950526	-	-	-	-	-	-	-
8.2L	600	SC		502	8	4	1991-1992	D456489 - D456768	-	-	-	-	-	-	-
8.2L	600	SC GEN V		502	8	4	1992-1996	D725676 - F877642	-	-	-	-	-	-	-
8.2L	600	SC GEN VI		502	8	4	1997-2000	K000227 - L601186	-	-	-	-	-	-	-
8.2L	8.2L	MAG		502	8	4	2010	A350340 & SUP	-	-	-	-	-	-	-
8.2L	8.2L	MIE		502	8	4	2010	A350802 & SUP	-	-	-	-	-	-	-
8.2L	8.2L	MIE W/HURTH		502	8	4	1990-1992	C878221 - D857199	-	-	-	-	-	-	-
8.2L	8.2L	W/HURTH (IB)		502	8	4		D857200 & Sup	18-1334	18-1333	18-1332	-	-	-	-
8.2L	8.2L	MIE GEN V		502	8	4		D857200 - F819619	-	-	-	-	-	-	-
8.2L	8.2L	MPI GEN VI / 8.2L MIE GEN VI / 8.2LH GEN VI		502	8	4	1996-2001	F819620 - L674200	-	-	-	-	-	-	-
	500	BULLDOG		540	8	4	1990-1996	C577254 - F745405	-	Ⓛ	Ⓛ	-	-	-	-
	500	BULLDOG		540	8	4	1997-2001	K000248 - M050281	-	Ⓛ	Ⓛ	-	-	-	-
	575			540	8	4	1986-1992	A677429 - D763716	-	Ⓛ	Ⓛ	-	-	-	-
	800	SC GEN V		540	8	4	1993-1998	D763836 & SUP	-	Ⓛ	-	-	-	-	-
	888		FORD		8	4		4762210 & Sup	18-1308	18-1309	18-1341	-	-	-	-
	898 / 198		GM					A338553 & sup	18-1308	18-1309	18-1341	-	-	-	-

Ⓛ 8 PAR CONJUNTO COJINETES

MERCURISER 3.7L APLICACIÓN COJINETES

Modelo	Número serie	COJINETE BIELA			COJINETE PRINCIPAL			PRINCIPAL (COJINETE EMPUJE)		
		Std.	.010	.020	Std.	.010	.020	Std.	.010	.020
165\3.7 (4cil)	6916779 & Sup	18-1148	-	-	-	-	-	18-1149	-	-
170 (4cil)	6916779 & Sup	18-1148	-	-	-	-	-	18-1149	-	-
180\3.7L (4cil)	6916779 & Sup	18-1148	-	-	-	-	-	18-1149	-	-
190 (4cil)	6916779 & Sup	18-1148	-	-	-	-	-	18-1149	-	-
470	4208730 & Sup	18-1148	-	-	-	-	-	18-1149	-	-
485	5685394 & Sup	18-1148	-	-	-	-	-	18-1149	-	-
488	6170297 & Sup	18-1148	-	-	-	-	-	18-1149	-	-

 <p>18-0518 RETÉN VÁLVULA Reemplaza: 26-34217, 26-72564, 26-58094, 26-75413, 26-75624</p>	 <p>18-4023 RETÉN VÁLVULA Reemplaza: 26-75413, 26-75624, 26-72564, 26-58094 Para: 165, 170, 180, 190 4 cil. (224 CID) SN 6916779 y posteriores</p>	 <p>18-4022 RETÉN VÁLVULA Reemplaza: 26-75988, 26-75982, 26-67863, 26-49131, F3866612, FI1100968, FI1101117 Para: 330 (SN 4623115 & posteriores), 340 (IB) (SN 5889914 & posteriores), 454 Mag (SN A631894 & posteriores)</p>	 <p>Pack. de 8</p> <p>18-4024 18-4024-9^② RETÉN VÁLVULA Reemplaza: 26-97664, 26-976641 26-8M0050563, FI1101200</p>
 <p>RETENES CIGÜEÑAL 1 PIEZA 18-1234 Reemplaza: 24-811554, 24-17057A1, 24-801879, 24-801879T Para: 7.4L, GL, GI, GSI: 8.2L, GL</p> <p>18-0519 Reemplaza: 26-14240, FI1101300 4.3L/3.0L/5.0L 5.7L</p> <p>18-0864 Reemplaza: 26-90925, 27-67389</p>	 <p>RETENES CIGÜEÑAL 2 PIEZAS</p> <p>18-0528 Reemplaza: 26-56868</p> <p>18-1211 Reemplaza: 26-58203, 26-49947, 26-814622, FI110026, FI110027, FI110041</p>	 <p>RETENES TAPA DISTRIBUCIÓN</p> <p>18-1213 Reemplaza: 97355, 79223, 59341, 59341A1, FI1100622, FI1101014</p> <p>18-1233 Reemplaza: 26-8219471, 26-821947, 26-49154, FI1100986</p> <p>18-0578 Reemplaza: 26-67388</p>	

APLICACIONES RETENES MERCURISER

Modelo	Número serie	Retén Principal Trasero	Retén Tapa distribución
120/2.5L	1666601 & SUP	—	18-1213
120/2.5L	2786857 & SUP	18-1211	18-1213
140/3.0L & LX	2508261 & SUP	—	18-1213
140/3.0L & LX	6229718 & SUP	18-1211	18-1213
150/160/165/200 (I/L-6)	1666495 & SUP	—	18-1213
150/160/165/200 (I/L-6)	2770032 & SUP	18-1211	18-1213
175/185/205/262/4.3L (V-6)	6330183 & SUP	18-1211	18-1213
200/228/225/230/250/255/260/270 280/300/320/5.0L/5.7L/898(V-8)	2453769 & SUP	18-1211 ^①	18-1213
215	2781153 & SUP	18-0528	—
224I/L4	TODOS	18-0864	18-0578
225 FORD	3885721 & SUP	18-0528	—
5.0L/5.7L, 4.3L, 3.0L Rotación Std.	“Todos” Retén una pieza	18-0519	18-1213
340 (7.4L)	4623115 & SUP	—	18-1233
370 TRS	5889914 & SUP	—	18-1233
400 TRS	4179554 & SUP	—	18-1233
420	A398941 & SUP	—	18-1233
440 TRS	4179554 & SUP	—	18-1233
454 MAGNUM	A631894 & SUP	—	18-1233
460 TRS	4179554 & SUP	—	18-1233
7.4L/8.2L/454/502 Rotación Std.	“Todos” Retén una pieza	18-1234	18-1233
7.4 BRAVO	B771113 & SUP	—	18-1233
888 (188)	3108723 & SUP	18-0528	—

① Cigüeñal largo motores GM

② Precio por envase



JUNTAS Y KITS PARA CODOS Y COLECTORES



18-0403
KIT JUNTAS DE ADMISIÓN
 Reemplaza: 27-805722A1, 27-812712, 27-61782, 27-52571
 Para: MCM 370, 400, 325, 454, 502 Mag, 7.4L Bravo II & MIE 8.2L1978-1997



18-0404
KIT JUNTAS DE ADMISIÓN
 Reemplaza: 27-805403A1
 Para: MCM/MIE 454 Mag MPI, 7.4L/LX MPI & 8.2L MPI 1993-SUP



18-0603
JUEGO DE JUNTAS COLECTOR DE ESCAPE
 Para: Motores Ford 302/351 CID
 Para usar con 18-1998-1

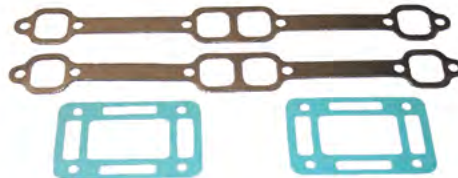

18-0604
JUEGO DE JUNTAS COLECTOR DE ESCAPE
 Para: Motores GM 305/350 CID
 Para usar con 18-1997-1



18-4347-1
JUEGO DE JUNTAS COLECTOR ESCAPE
 Para: GM 175, 185, 205 (229 & 262 CID)

— CONTIENE —

Ref #	Descripción	O.E. #	Cant.
18-0897	Junta codo escape	27-41813-1	2
18-2909	Junta colector escape	27-99757	2



18-4348
JUEGO DE JUNTAS COLECTOR DE ESCAPE
 Para: GM 454, 525 (7.4L & 8.2L)

— CONTIENE —

Ref #	Descripción	O.E. #	Cant.
18-0418	Junta	27-46820	2
18-0897	Junta codo escape	27-41813-1	2



18-4408
JUEGO DE JUNTAS COLECTOR DE ADMISIÓN
 Reemplaza: 27-11977, 27-11987
 Para: Motores GM 262 CID 175, 185 y 205 HP



18-4349
JUEGO DE JUNTAS COLECTOR DE ESCAPE
 Para: GM 200, 228, 230, 260, 898 (5.0 & 5.7L)

— CONTIENE —

Ref #	Descripción	O.E. #	Cant.
18-2949	Junta colector escape	27-33395	2
18-0897	Junta codo escape	27-41813-1	2

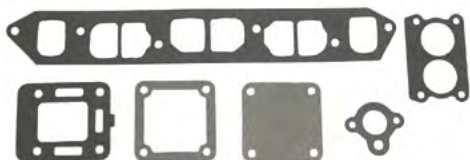

18-4367
JUEGO DE JUNTAS COLECTOR DE ESCAPE
 Reemplaza: 27-99777A1
 Para: Motores GM 153 & 181 (2.5 & 3.0L) CID ; 120 & 140 HP S/N 6229718 & SUP
 (Con culatas babor siamesas)

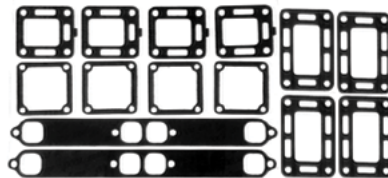

18-4394
JUEGO JUNTAS COLECTOR ESC.
 Reemplaza: 27-33395A2, 27-33395A1
 Para: GM 350 (5.7L) CID Eng; 250 HP S/N 4768000-4908849 255 HP S/N 5195909 & sup

— CONTIENE —

Ref #	Descripción	O.E. #	Cant.
18-2832-1	Junta tapa colector	27-48043	4
18-2833	Junta codo escape	27-99777-2	4
18-2949	Junta colector escape	27-33395	2
18-0885-1	Junta codo escape	27-48042	4

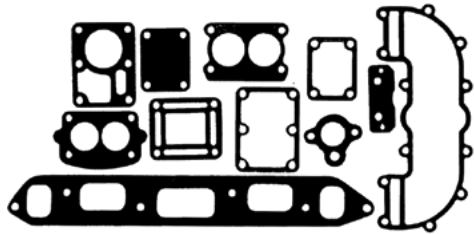

18-4395
JUEGO DE JUNTAS COLECTOR ESCAPE
 Reemplaza: 27-35898A4, 27-35898A3, 27-35898A2
 Para: GM 153 (2.5L) CID;
 120 HP S/N 2046625-6229717

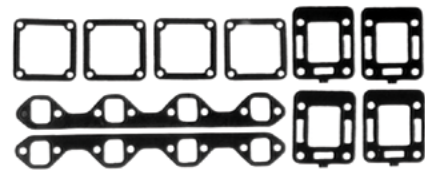

18-4399
JUEGO DE JUNTAS COLECTOR ESCAPE
 Reemplaza: 27-54566A1
 Para: motores Ford 302/351 (5.0L & 5.8L) CID; Todos 888 (188 HP)
 & 233 HP, 255 HP S/N 3258728-4175498
 - CONTIENE -

Ref #	Descripción	O.E. #	Cant.
18-0183-1	Junta escape	27-46820	2
18-2832-1	Junta tapa lateral colector	27-48043-1	4
18-2833	Codo escape junta	27-99777-2	4

18-4396
JUEGO DE JUNTAS COLECTOR DE ESCAPE
 Reemplaza: 27-46401A1
 Para: Motores 250 (4.1L) CID; 165 HP S/N 2770032 & SUP
 - CONTIENE -

Ref #	Descripción	O.E. #	Cant.
18-2830-1	Junta colector	27-46401	1
18-2831	Junta termostato	27-47590-1	1
18-2832-1	Junta tapa lateral colector	27-48083-1	2
18-2833	Junta codo escape	27-99777-2	1
18-0353	Junta	27-58764	1
18-0356	Junta	27-64692	1
18-0928-1	Junta tapa lateral	27-73814	1

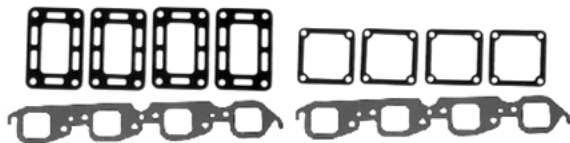
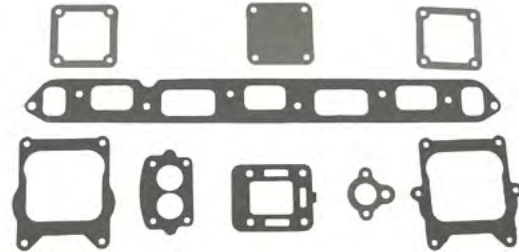

18-4397
JUEGO DE JUNTAS COLECTOR DE ESCAPE
 Reemplaza: 27-46820A1
 Para: Motores GM 454 (7.4L) CID; Todos 325, 350, 400 HP Jet Drives 330 HP S/N 6083144 & post
 - CONTIENE -

Ref #	Descripción	O.E. #	Cant.
18-0418	Junta escape	27-46820	2
18-0885-1	Junta codo escape	27-48042	4
18-2832-1	Junta tapa lateral colector	27-48043-1	4

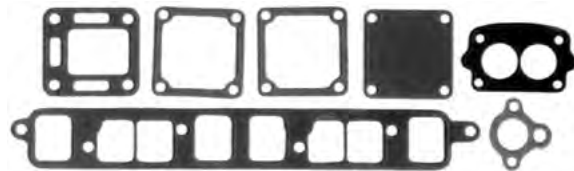

18-4399
JUEGO DE JUNTAS COLECTOR DE ESCAPE
 Reemplaza: 27-53354A1
 Para: Motores GM 181 (3.0L) CID; 140 HP S/N 3332137-6229717
 (Sin cilindro de babor siames)

JUEGOS JUNTAS CULATA Y COLECTOR ADMISIÓN

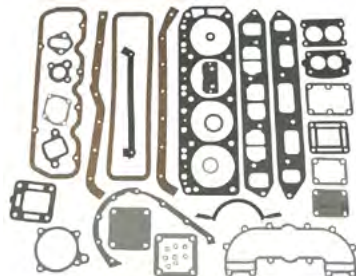

18-4383
 Para: Motores GM 153 (2.5L) CID;
 S/N 2324347 & SUP Incluye juntas culata 18-3880

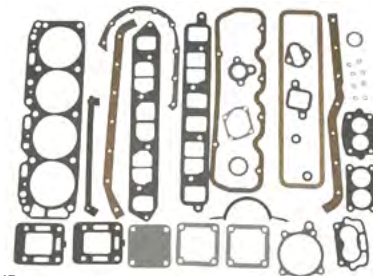

18-4384
 Para: Motores GM 181 (3.0L) CID;
 S/N 2508261-6229717 (Excepto 3.0LX)

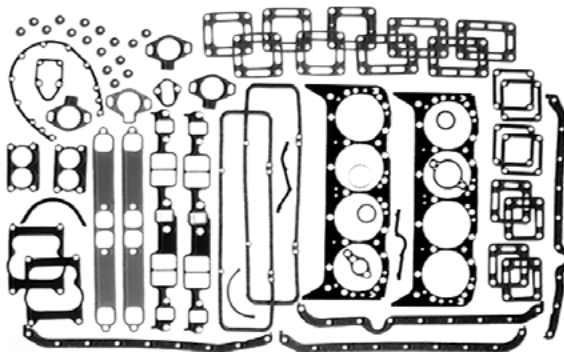

18-4386
 Para: Motores GM 305 & 350 (5.0L & 5.7L) CID; Con culatas (1987 & anteriores)

- CONTIENE -

Ref #	Descripción	O.E. #	Cant.
18-0976	Junta tapa	27-14250	1
18-0868	Junta entrada colector	27-17145	1
18-2949	Junta colector escape	27-33395	2
18-0897	Junta codo escape	27-41813	2
18-0885-1	Junta codo escape	27-48042	4
18-2917	Junta alojamiento termostato	27-53045-1	1
18-0153	Junta	27-85817A1	1
18-2848	Base quadrajat junta carburador	27-58457-2	2
18-2849-1	Junta codo escape	27-87105-1, 27-818832	4
18-3876	Junta culata	27-75611	2
18-2554	Junta termostato	27-41812	1
18-2832-1	Junta tapa lateral colector	27-48043-1	4
18-2553	Junta termostato	27-47510	1
18-2833	Junta colector	27-99777-2	4
18-2844	Junta tapa termostato	27-48818-1	1
18-0889	Junta alojamiento bomba de agua	27-34213	1
18-0891	Junta bomba agua	27-34897	1
18-0905	Junta tapón	27-49955	1
18-0876	Junta bomba agua	27-34898	1
18-0994	Junta	27-70143-1	2
18-0518	Retén	26-34217	16
18-2845	Junta tapa válvula	121-122	2

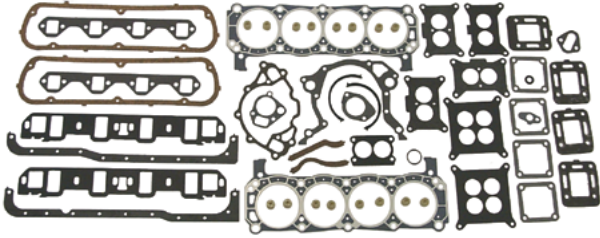

18-4385
Para: Motores Ford 302 (5.0L) CID; 215, 225 & 888 (188 HP)
Incluye junta culata 18-3883

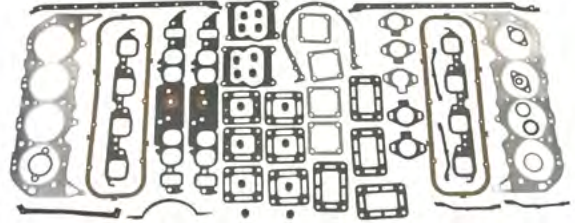

18-4387
Reemplaza: 27-801853
Para: Motores GM 454 (7.4L) CID; Salida oval
Incluye junta culata 18-3877



18-0465
JUEGO JUNTAS COLECTOR ADMISIÓN
Reemplaza: 27-65184, 27-8M0050224
Para: motores GM 454 CID, 325, 330, 340, 350 HP
y 454 Magnums, 7.4L

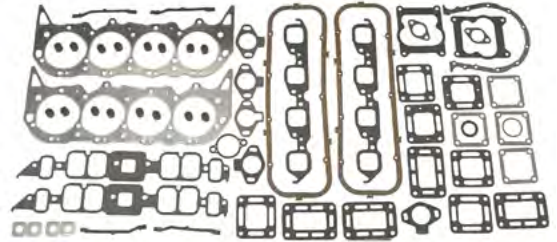

18-4365
JUEGO DE JUNTAS COLECTOR DE ESCAPE
Reemplaza: 27-801855
Para: motores GM 454 (7.4L) CID; Modelos salida rectangular
Incluye junta culata 18-3877

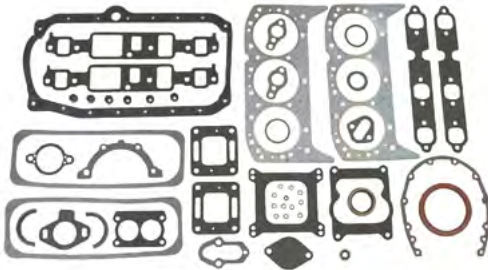

18-4388
JUEGO JUNTAS COMPLETO
Reemplaza: 27-11977A88, A92
Para: motores GM 262 CID; 175, 185 & 205 HP, 4.3L
Incluye junta culata 18-3879

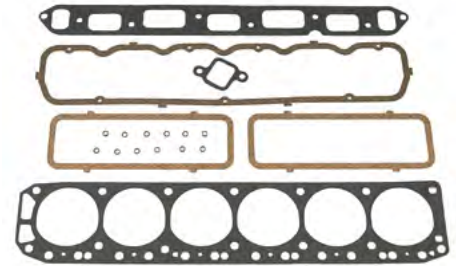

18-4389
JUEGO DE JUNTAS COLECTOR ADMISIÓN
Reemplaza: 27-47453A1
Para: Todos GM 165 HP (S/N 270032 & SUP) & En línea 6 cil.
250 CID

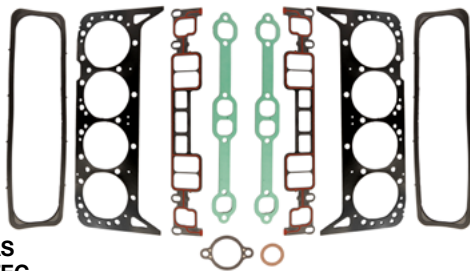

18-1254
JUEGO JUNTAS CULATA VORTEC
Reemplaza: 27-75611A03
Para: Motores bloques pequeños GM V8 con Vortec.

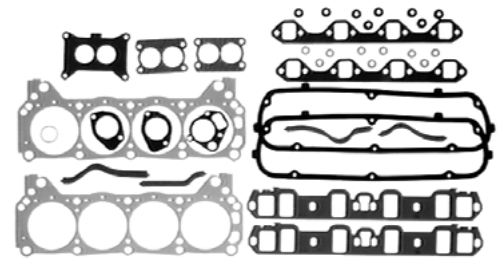

18-4391
JUEGO JUNTAS COLECTOR ADMISIÓN
Reemplaza: 27-64763A2
Para: Motores Ford 351 CID; 233 HP S/N 4173000-4500860, 5.8L
Incluye junta culata 18-3883

18-4392
JUEGO JUNTAS COLECTOR ADMISIÓN
Reemplaza: 27-75611A2, 27-75611A1
Para: motores GM 305 & 350 CID. 898 (198 HP) 200, 228, 230/260 (Intraborda) 230, 250, 255, 260, 280 & 5.7L Ski

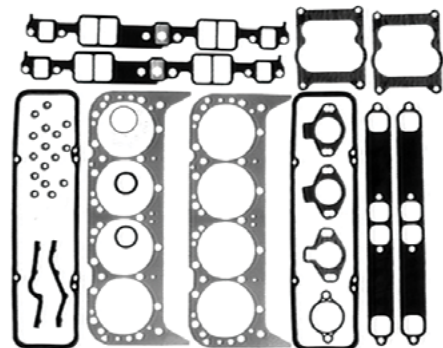

— CONTIENE —

Ref #	Descripción	O.E. #	Cant.
18-0868	Junta entrada colector	27-17145	1
18-2949	Junta colector escape	27-33395	2
18-2848	Base quadrajat junta carburador	27-52457-2	2
18-3876	Junta culata	27-75611	2
18-2553	Junta termostato	27-47510	1
18-2844	Junta tapa termostato	27-48818-1	1
18-2554	Junta termostato	27-41812	2
18-2917	Junta alojamiento termostato	27-53045-1	1
18-2845	Junta tapa válvula	27-11999	2
18-0518	Retén	26-34217	16

KITS JUNTAS

(Los juegos de juntas no incluyen los retenes de cigüeñal)

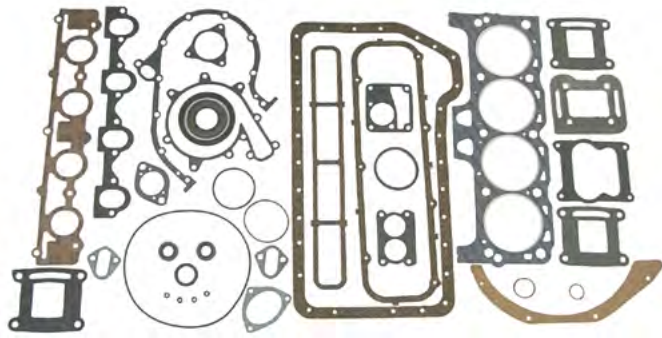

18-4381

Reemplaza: 27-43186A1, 27-89656A1, 27-41636A1
 Para: Motores 224 (3.7L) CID ; 165, 170, 180, 190 HP
 S/N 6916779 & SUP

-- CONTIENE --			
Ref #	Descripción	O.E. #	Cant.
18-0175	Aro	25-26543	4
18-0860	Aro	25-62700	1
18-0864	Retén	26-90925	1
18-0881-1	Junta codo escape	27-18272	1
18-0992	Junta escape	27-68715	1
18-0994	Junta montaje carburador	27-70143-1	1
18-0158	Junta entrada colector	27-70905	1
18-0111	Junta codo escape	27-89657	2
18-0160	Junta escape colector	27-94136	1
18-0113-1	Junta codo escape	27-97542	1
18-2843	Junta tapa termostato	27-74830	1
18-2848	Junta base quadrajat	27-52457-2	1
18-3878	Junta culata	27-13709T	1
18-7121	Aro	25-35027	1
18-0874	Junta distribuidor	27-34486	1
18-0185	Retén	27-91892	1
18-2555	Junta termostato	27-89656-1	1
18-0889	Junta bomba combustible	27-34213	1
18-4366	Juego de juntas	27-72479A5	1
18-0387	Junta tapa volante	27-94976	1
18-0172	Retén aceite	26-97530	2

Kits juntas
MERCURUISER

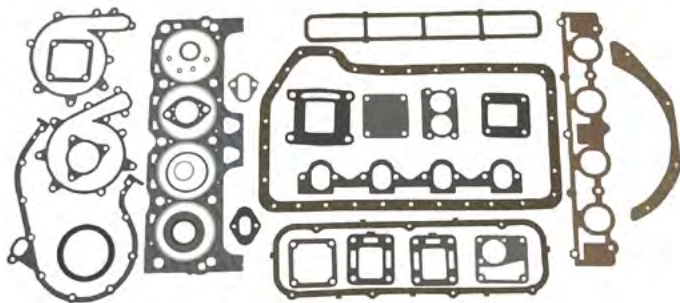

18-4382

Reemplaza: 27-74830A3, 27-74830A1, 27-74264A1
 Para: Motores 224 (3.7L) CID; 470 S/N 4208730 & SUP

-- CONTIENE --			
Ref #	Descripción	O.E. #	Cant.
18-0864	Retén	26-90925	1
18-0956-1	Junta montaje colector escape	27-68715	1
18-0158	Junta entrada colector	27-70905	1
18-0950	Junta tapa impulsor	27-88046	1
18-0954	Junta montaje escape	27-92720	1
18-0113-1	Junta montaje codo escape	27-97542	1
18-2832-1	Junta tapa lateral colector	27-48043-1	2
18-2833	Junta codo	27-99777-2	2
18-2843	Junta tapa termostato	27-74830	1
18-3878	Junta culata	27-13709T	1
18-0175	Aro	25-26543	4
18-0889	Junta montaje bomba combustible	27-34213	1
18-7121	Aro	25-35029	1
18-0874	Junta distribuidor	27-34486-3	1
18-0928-1	Junta tapa lateral colector	27-73814	1
18-0994	Junta montaje carburador	27-70143-1	1
18-2555	Junta tapa termostato	27-89656-1	1
18-4366	Juego de juntas carter	27-72479A5	1
18-0387	Juntas tapa volante	27-94976	1

JUEGO DE JUNTAS VARIOS

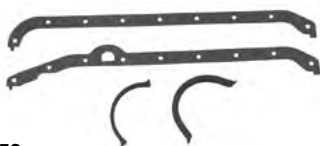

18-0153

JUEGO DE JUNTAS CARTER
 Reemplaza: 27-85817A1, FI5110037, FI5110032, 27-72627
 Para: Mercruiser GM 350 CID (5.7L)



18-0340

JUEGO DE JUNTAS CARTER
 Reemplaza: 27-49949, 27-34207
 Para: Mercruiser 160/165 (6 cil.)

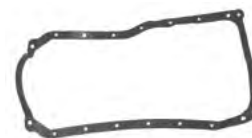

18-1239

JUNTA CARTER
 Reemplaza: 27-810846T, 27-810846
 Para: Mercruiser 3.0L GM 181



18-0348

JUEGO DE JUNTAS CARTER
 Reemplaza: 27-52550, 27-49107, FI1100229, FI5000229, FI5000245
 Para: Motores Mercruiser GM 454/502 CID; (7.4L y 8.2L)



18-1237

JUNTA CARTER
 Reemplaza: 27-138651, 27-13865, FI1101281
 Para: Mercruiser GM 5.7L



18-0466

JUEGO DE JUNTAS CARTER
 Reemplaza: 27-14901A1, 27-14901, 27-52144
 Para: Mercruiser GM 153/181 (2.5L & 3.0L)



18-1232

JUNTA CARTER
 Reemplaza: 27-811566, 27-845628
 Para: GM bloque grande



18-1231

JUNTA ADMISIÓN
 Reemplaza: 27-8181881, 27-818188
 Para: Salida rectangular y bloque alto rendimiento Chevy



18-0405

JUNTA CARTER
 Reemplaza: 27-14247-1, 27-883964, 27-14247, 27-883964, 27-883964T
 Para: motores Mercruiser GM 262 CID. (4.3L)



18-1238
JUEGO DE JUNTAS ADMISIÓN
Reemplaza: 27-824326
Para: Mercuruiser 4.3L/LX modelos,
pre SN F802999



18-0407
JUEGO JUNTAS CARTER
Reemplaza: 27-64798, 27-56870A1
Para: Mercuruiser: 215, 225, 888



18-0410
JUEGO JUNTAS COLECTOR DE ADMISIÓN
Reemplaza: 27-75648
Para: motores Ford 5.0L/302, 5.8L/351 CID;
(233HP) S/N 3108723 & SUP



18-0411
JUEGO JUNTAS CARTER
Reemplaza: 27-90458A1,
27-90458, FI5000178, FI5000183
Para: Mercuruiser GM 350 CID (5.7L)
Varilla estribor



18-0611
JUEGO JUNTAS CARTER
Reemplaza: 27-75483
Para: motores Mercuruiser Ford 351 CID.

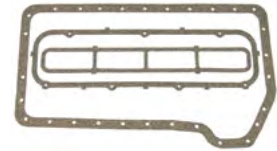

18-4366
JUEGO DE JUNTAS CARTER
Reemplaza: 27-72479A5,
27-72479T, 27-72479
Para: Mercuruiser 224 CID (3.7L)

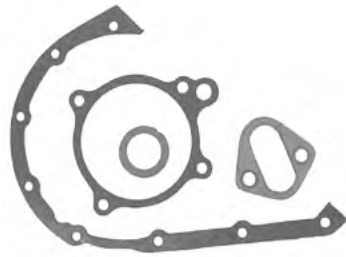

18-4375
KIT DE JUNTAS CADENA DISTR.
Reemplaza: 27-34213A2, 27-34213A1
Para: motores Mercuruiser GM 153 & 181 CID: 110,
120, 130, 140, 150, 160 & 165 HP; 2.5L & 3.0L

— CONTIENE —

Ref #	Descripción	O.E. #	Cant.
18-0889	Junta bomba combustible	27-34213	1
18-0887	Junta tapa distribución	27-49953	1
18-0948	Junta distribuidor	27-87707	1
18-0327	Junta bomba agua	27-33956	1



18-0868
JUEGO JUNTAS COLECTOR ADMISIÓN
Reemplaza: 27-17145,
27-72637, FI5000263, FI5000232, FI1101296
Para: Mercuruiser 305, 350

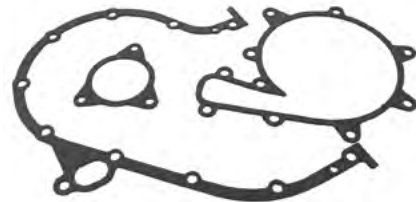



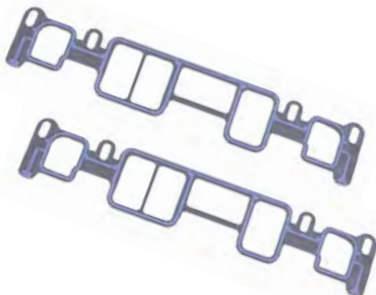



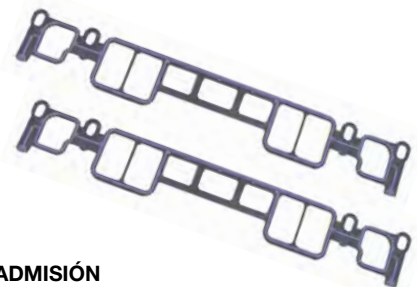







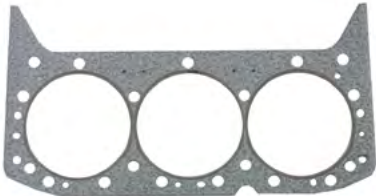

18-4380
KIT DE JUNTAS CADENA DISTRIBUCIÓN
Reemplaza: 27-68714A6, 27-68714A7, 27-68714, 27-72098
Para: Motores Mercuruiser 224 CID.
165, 170, 180, 190, 470, 485 & 488 HP



18-0487
JUEGO JUNTAS ADMISIÓN
Reemplaza: 27-8243261, 27-824326002
Para:MCM 262 Mag & 4.3L/LX/LH/LXH Gen II (1996-sup)



18-0488
JUEGO JUNTAS ADMISIÓN
Reemplaza: 27-807473A1
Para :MCM 350 Mag, 5.0L & 5.7L/LX Gen II (1996-sup)













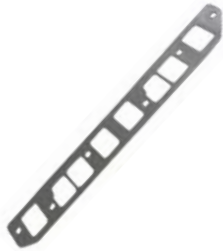





 <p>18-2946 MER52364-OEM JUNTA CULATA Reemplaza: 27-52364, 27-81084, F15000204 Para: motores GM 181 (3.0L) CID.</p>	 <p>18-3874 JUNTA CULATA Reemplaza: 27-811546, 27-879150139 Para: (8.2L) 502 CID</p>	 <p>18-3876 JUNTA CULATA Reemplaza: 27-75611, 27-75611001, 27-48330, 27-34278 Para: motores GM 305 (5.0L)/350 (5.7L) CID.</p>	
 <p>18-3877 JUNTA CULATA Reemplaza: 27-13218, 27-13687, 27-19315, 27-49104, 27-61224, 27-97529, 27-8M0049045 Para: motores GM 454 (7.4L) CID., Mark IV (pre-1992)</p>	 <p>18-3878 JUNTA CULATA Reemplaza: 27-13709, 27-13709T, 27-74264, 27-79986, 27-92166, 27-922661 Para: Motores Mercruiser 224 (3.7L) CID. Modelo 470</p>	 <p>18-3879 JUNTA CULATA Reemplaza: 27-11986, 27-816460, 27-879150140, 27-42744 Para: motores GM 262 (4.3L) CID.</p>	
 <p>18-3880 JUNTA CULATA Reemplaza: 27-34273, 27-810841, 27-342731, 27-52364 Para: motores GM 153 (2.5L), (3.0L) CID.</p>	 <p>18-3881 JUNTA CULATA Reemplaza: 27-47453, 27-72622, 27-39164, 27-34274 Para: motores GM 250 (4.1L) CID (6 cil).</p>	 <p>18-3883 JUNTA CULATA Reemplaza: 27-75647, 27-75646, 27-64763, 27-56110 Para: motores Ford 302 (5.0L) 351 (5.8L) CID.</p>	
 <p>18-3887 JUNTA CULATA Reemplaza: 27-850470, 27-879150141, 27-811547 Para: (7.4L) 454 CID GEN V y VI (1992-sup)</p>	 <p>18-0353 JUNTA MONTAJE CARBURADOR Reemplaza: 27-58764</p>	 <p>18-0354 JUNTA MONTAJE CARBURADOR Reemplaza: 27-60715</p>	 <p>18-0685 JUNTA TAPA VÁLVULA Reemplaza: 27-73666 224 CID (3.7L)</p>
 <p>18-0356 JUNTA MONTAJE CARBURADOR (Para Rochester) Reemplaza: 27-64692, 27-32910</p>	 <p>18-0357 JUNTA MONTAJE CARBURADOR Reemplaza: 27-65577, 27-56884</p>	 <p>Pack. de 2 18-0876 18-0876-9① JUNTA BOMBA COMBUSTIBLE Para GM 4.3L, 5.0L & 5.7L Reemplaza: 27-34898, F15005756</p>	 <p>Pack. de 2 18-0889 18-0889-9① JUNTA BOMBA COMBUSTIBLE Para GM 4.3L, 5.0L & 5.7L Reemplaza: 27-34213, 27-56883, F15000074</p>

① Precio por pack





















 <p>18-0360 JUNTAS MONTAJE CARBURADOR Reemplaza: 27-70142</p>	 <p>18-0462 JUNTA MONTAJE CARBURADOR Reemplaza: 27-48399</p> <table border="1"> <thead> <tr> <th>Modelo</th> <th>Año</th> <th>S/N</th> </tr> </thead> <tbody> <tr> <td>250</td> <td>1968-69</td> <td>2314301-2639854</td> </tr> <tr> <td>270</td> <td>1969-72</td> <td>2851074-3385720</td> </tr> <tr> <td>325</td> <td>1969-70</td> <td>2278747-3042730</td> </tr> <tr> <td>390</td> <td>1969-70</td> <td>2781129-3042731</td> </tr> </tbody> </table>	Modelo	Año	S/N	250	1968-69	2314301-2639854	270	1969-72	2851074-3385720	325	1969-70	2278747-3042730	390	1969-70	2781129-3042731	 <p>18-0463 JUNTA MONTAJE CARBURADOR (Para Weber) Reemplaza: 27-814210</p>	 <p>18-0467 JUNTA MONTAJE CARBURADOR (Para Weber) Reemplaza: 27-41610, 27-49814</p>
Modelo	Año	S/N																
250	1968-69	2314301-2639854																
270	1969-72	2851074-3385720																
325	1969-70	2278747-3042730																
390	1969-70	2781129-3042731																
<p>Pack de 2</p>  <p>18-0994 18-0994-9^① JUNTA MONTAJE CARB Reemplaza: 27-701431, 27-8079821, 27-807982, 27-70143, 27-807982B, 27-70143B1</p>	<p>Pack de 2</p>  <p>18-2848 18-2848-9^① JUNTA BASE CARBURADOR Reemplaza: 27-524572, 18-52457, 18-524571</p>	<p>Pack. de 2</p>  <p>18-0874 18-0874-9^① JUNTA DISTRIBUIDOR Para GM V6 & V8 Reemplaza: 27-344863, 27-344861, 27-34486, 27-52184, 27-34891, FI5000162, F3932344 Para: 2.6L (1989), 3.5L (1989), 4.3L (1987-93), 5.0L (1987-88), 5.7L (1987-92), 7.4L (1988-93), 8.2L (1992-93)</p>	<p>Pack de 2</p>  <p>18-0948 18-0948-9^① JUNTA DISTRIBUIDOR Reemplaza: 27-87707 4 Cil.</p>															
<p>Pack de 2</p>  <p>18-2552 18-2552-9^① JUNTA TERMOSTATO Reemplaza: 27-331792, 27-331791</p>	<p>Pack de 2</p>  <p>18-0667 18-0667-9^① JUNTA TAPA CONECTOR Reemplaza: 27-995061, 27-99506</p>	 <p>18-0422 JUNTA TAPA DISTRIBUIDOR Reemplaza: 391-5076 V8</p>	 <p>18-0740-1 JUNTA CUERPO ACELERADOR Reemplaza: 27-805396</p>	<p>Pack. de 2</p>  <p>18-2553 18-2553-9^① JUNTA TERMOSTATO Reemplaza: 27-47510, 27-47510Q GM V-6, V-8</p>														
<p>Pack. de 2</p>  <p>18-2554 18-2554-9^① JUNTA TERMOSTATO Reemplaza: 27-41812, 27-90556, 27-41812Q V-6 & V-8</p>	<p>Pack. de 2</p>  <p>18-2555 18-2555-9^① JUNTA TERMOSTATO Reemplaza: 27-896561, 27-89656 4 Cil.</p>	<p>Pack de 2</p>  <p>18-2831 18-2831-9^① JUNTA TERMOSTATO Reemplaza: 27-475901, 27-47590 4 & 6 Cil.</p>	<p>Pack de 2</p>  <p>18-2834 18-2834-9^① JUNTA TERMOSTATO Reemplaza: 27-60208 Ford V-8</p>															
<p>Pack de 2</p>  <p>18-2843 18-2843-9^① JUNTA TERMOSTATO Reemplaza: 27-74830 470</p>	<p>Pack de 2</p>  <p>18-2844 18-2844-9^① JUNTA TERMOSTATO Reemplaza: 27-48818, 27-488181, 27-48818Q1 V-8</p>	<p>Pack de 2</p>  <p>18-2917 18-2917-9^① JUNTA TERMOSTATO Reemplaza: 27-53045, 27-530451, 27-33179, F10077105, FI1101276, FI1101291, FI5000096</p>	<p>Pack de 2</p>  <p>18-0398 18-0398-9^① JUNTA TERMOSTATO Replaces: 27-8M2021920, 27-33918</p>															











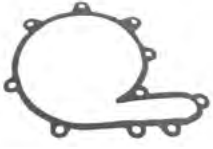









① Precio por pack

 <p>18-0111 JUNTA CODO ESCAPE Reemplaza: 27-89657</p>	 <p>18-0113-1 JUNTA CODO ESCAPE Reemplaza: 27-97542, 27-856705</p>	 <p>Pack de 2 18-0672 18-0672-9① JUNTA CODO ESCAPE Reemplaza: 27-860231, 8637251</p>	 <p>18-0365 JUNTA INTERCAMBIADOR 2 3/4" dia. Reemplaza: 27-75450 224 CID</p>
 <p>18-0389 JUNTA INTERCAMBIADOR 3 15/16" dia. Reemplaza: 27-99960</p>	 <p>18-0881-1 JUNTA CODO ESCAPE Reemplaza: 27-18272</p>	 <p>Pack. de 2 18-0885-1 18-0885-9① JUNTA CODO ESCAPE Reemplaza: 27-48042</p>	 <p>18-0897  MER278637240 Original JUNTA CODO ESCAPE Reemplaza: 27-41813</p>
 <p>Pack de 2 18-0928-1 18-0928-9① JUNTA COLECTOR Reemplaza: 27-73814, 27-738141, 27-807218</p>	 <p>18-0954 JUNTA CODO ESCAPE Reemplaza: 27-92720</p>	 <p>Pack de 2 18-2819-1 18-2819-9① JUNTA CODO ESCAPE Reemplaza: 27-39915</p>	 <p>Pack de 2 18-2832-1 18-2832-1-9① JUNTA COLECTOR Reemplaza: 27-480431, 27-48043</p>
 <p>Pack de 2 18-2833 18-2833-9① JUNTA CODO ESCAPE Reemplaza: 27-997772, 27-997771, 27-99777, 27-52076</p>	 <p>Pack de 2 18-2849-1 18-2849-9-1① JUNTA CODO ESCAPE Reemplaza: 27-87105, 27-871051, 27-860232, 27-818832, 27-863726</p>	 <p>18-1210-1 JUNTA TAPA Reemplaza: 27-39923</p>	 <p>18-0158 JUNTA COLECTOR ADMISIÓN Reemplaza: 27-70905 Para: 3.7L</p>  <p>18-0183-1 JUNTA COLECTOR ESCAPE Reemplaza: 27-73866, 27-54566</p>
 <p>18-0418 JUNTA COLECTOR ESCAPE Reemplaza: 27-46820</p>	 <p>18-2830-1 JUNTA COLECTOR ESCAPE En linea 6 cil. Reemplaza: 879036, 27-46401, 27-52584, 27-33121</p>	 <p>18-0680 JUNTA COLECTOR ESCAPE Reemplaza: 27-815528</p>	 <p>18-2896-1 JUNTA COLECTOR ESCAPE Reemplaza: 27-52546, 27-32816</p>

<p>Pack de 2</p>  <p>18-2909 18-2909-9① JUNTA COLECTOR ESCAPE Reemplaza: 27-99757</p>	 <p>18-2949 JUNTA COLECTOR ESCAPE Reemplaza: 27-33395 GM 5.0L & 5.7L</p>	 <p>18-2912-1 JUNTA COLECTOR ESCAPE Reemplaza: 27-53354</p>	 <p>18-0956-1 JUNTA COLECTOR ESCAPE Reemplaza: 27-68715</p>																											
<p>Pack de 2</p>  <p>18-1204-1 18-1204-1-9① JUNTA COLECTOR ESCAPE Reemplaza: 27-96429</p>	 <p>18-0664 JUNTA TAPA VÁLVULA Reemplaza: 27-17467, FI1101287 Para: GM 305/350, 5.0 & 5.7L</p>	 <p>18-2845 JUNTA TAPA VÁLVULA Reemplaza: 27-11999, 27-34043, 27-52202, FI1101236, FI5000161 V-8 GM 305/350 CID, 5.0 & 5.7L</p>	 <p>18-25001 JUNTA TAPA VÁLVULA Reemplaza: 27-14765, F3860315, FI1110294, FI1110958 Para: GM 454, 7.4L</p>																											
 <p>18-25002 JUNTA TAPA VÁLVULA Reemplaza: 27-811588 Para: GM 454, 502, (1992-SUP)</p>	 <p>18-0311 JUNTA TAPA VÁLVULA Reemplaza: 27-11988 Para: 4.3 Litros 262 CID</p>	 <p>18-0346 JUNTA TAPA VÁLVULA Reemplaza: 27-49936, 27-34042 Para: GM 250 CID (4.1L), 160/165/200 (6 cil.)</p>	 <p>18-0347 MER851040 OEM JUNTA TAPA VÁLVULA Reemplaza: 27-52145, 27-806452, 27-34041 Para: GM 153 & 181 CID (2.5L & 3.0L)</p>																											
 <p>18-0352 JUNTA TAPA VÁLVULA Reemplaza: 27-56173 Para: Ford 302/351 CID (5.0L & 5.8L)</p>	<p>Pack de 2</p>  <p>18-0464 18-0464-9① JUNTA TAPA VÁLVULA Reemplaza: 27-49121, 27-91831 Para: GM 454/502 CID (7.4L & 8.2L)</p> <table border="1"> <thead> <tr> <th>Modelo</th> <th>Año</th> <th>S/N</th> </tr> </thead> <tbody> <tr> <td>330</td> <td>1977-81</td> <td>4623115-6083144</td> </tr> <tr> <td>7.4 Bravo</td> <td>1988-91</td> <td>B771113-D603117</td> </tr> <tr> <td>454 Mag</td> <td>1986-92</td> <td>A631894-D805068</td> </tr> <tr> <td>370 TRS</td> <td>1978-87</td> <td>4179554-B714586</td> </tr> <tr> <td>400 TRS</td> <td>1980-86</td> <td>4179554-B457644</td> </tr> <tr> <td>400 TRS</td> <td>1983-86</td> <td>4179554-B485220</td> </tr> <tr> <td>460 TRS</td> <td>1983-86</td> <td>4179554-6181046</td> </tr> <tr> <td>502 Mag Bravo</td> <td>1990-92</td> <td>C878221-D824588</td> </tr> </tbody> </table>		Modelo	Año	S/N	330	1977-81	4623115-6083144	7.4 Bravo	1988-91	B771113-D603117	454 Mag	1986-92	A631894-D805068	370 TRS	1978-87	4179554-B714586	400 TRS	1980-86	4179554-B457644	400 TRS	1983-86	4179554-B485220	460 TRS	1983-86	4179554-6181046	502 Mag Bravo	1990-92	C878221-D824588	 <p>18-0468 JUNTA TAPA DISTRIBUCIÓN Reemplaza: 27-811572 GM 4.3L, 5.0L & 5.7L</p>
Modelo	Año	S/N																												
330	1977-81	4623115-6083144																												
7.4 Bravo	1988-91	B771113-D603117																												
454 Mag	1986-92	A631894-D805068																												
370 TRS	1978-87	4179554-B714586																												
400 TRS	1980-86	4179554-B457644																												
400 TRS	1983-86	4179554-B485220																												
460 TRS	1983-86	4179554-6181046																												
502 Mag Bravo	1990-92	C878221-D824588																												
<p>Pack. de 2</p>  <p>18-0887 18-0887-9① JUNTA TAPA DISTRIBUCIÓN Reemplaza: 27-49953, 27-34216, FI5000201 4 & 6 Cil.</p>	<p>Pack. de 2</p>  <p>18-0976 18-0976-9① JUNTA TAPA DISTRIBUCIÓN Reemplaza: 27-14250, 27-34895, FI1101297</p>	 <p>18-0980 JUNTA TAPA DISTRIBUCIÓN Reemplaza: 27-54529, 27-49109, 110990, 1100990 GM 7.4L</p>	<p>Pack. de 2</p>  <p>18-0328 18-0328-9① JUNTA TAPA VARILLA EMPUJE Reemplaza: 27-34208 153 & 181 CID, 120/140 (4 Cil.)</p>																											

① Precio por pack

 <p>18-0329 JUNTA TAPA VARILLA DE EMPUJE Reemplaza: 27-34209 Para: 140/150/160/165 (6 cil.)</p>	 <p>18-2815 MER8146801 OEM VARILLA DE EMPUJE Reemplaza: 27-814703, FI5000119, FI5000199 Para: 3.0L</p>	 <p>Pack de 2</p> <p>18-1210 18-1210-9① JUNTA TAPA LATERAL Reemplaza: 27-39923</p>	 <p>Pack de 2</p> <p>18-0185 18-0185-9① RETÉN ACEITE Reemplaza: 27-91892</p>
 <p>18-1240 JUNTA TAPA PARTE SUPERIOR Para Bravo Reemplaza: 12708</p>	 <p>Pack de 5</p> <p>18-2516 18-2516-9① JUNTA TRANSOM BRAVO Reemplaza: 16755, 16755A1, 16755Q1,</p>	 <p>Pack de 2</p> <p>18-2556 18-2556-9① JUNTA TRANSOM ALPHA ONE Reemplaza: 27-35996, A1</p>	 <p>18-2743 JUNTA TRANSOM ALPHA ONE Reemplaza: 27-94996, 27-949962, 27-94996A1, 27-94996A2, 27-94996Q2, 27-94996A3, 27-94996A20, 27-64818A2</p>
 <p>Pack de 5</p> <p>18-2820 18-2820-9① JUNTA TRANSOM ALPHA ONE Reemplaza: 27-64818, Q4, 27-64818A20, 27-64818A4, 27-64818A1, 27-45821</p>	 <p>Pack de 5</p> <p>18-2840 18-2840-9① JUNTA Reemplaza: 27-35982</p>	 <p>Pack de 2</p> <p>18-2847 18-2847-9① JUNTA TRANSOM Reemplaza: 27-54014, 27-54014A1, 27-54014Q1, 27-54014T1 Para: E, H, TR, TRS</p>	 <p>18-0386 JUNTA CUERPO BOMBA DE AGUA Reemplaza: 27-94914, 27-72780</p>
 <p>Pack de 2</p> <p>18-0894 18-0894-9① JUNTA TAPA AGUA Reemplaza: 27-55810, 27-55810 -1</p>	 <p>18-0916 JUNTA BOMBA AGUA Reemplaza: 27-8052151, 27-805215, 27-94915, 27-72779</p>	 <p>Pack de 2</p> <p>18-0903 JUNTA BOMBA AGUA Reemplaza: 27-49110, FI1101000 454 CID</p>	 <p>18-0147 JUNTA BOMBA AGUA Para Ford V-8 Reemplaza: 27-56880</p>
 <p>18-0327 JUNTA BOMBA AGUA Reemplaza: 27-33956, FI5000200, FI5000219 4 & 6 Cil.</p>	 <p>Pack. de 2</p> <p>18-0891 18-0891-9① JUNTA MONTAJE BOMBA DE AGUA Reemplaza: 27-34897, 27-34896, FI5000077, FI5000078 Para: GM 4.3L, 5.0L & 5.8L</p>	 <p>Pack. de 2</p> <p>18-0893 18-0893-9① JUNTA TRASERA BOMBA DE AGUA Reemplaza: 27-35380 GM 4.3L, 5.0L & 5.7L</p>	 <p>Pack de 2</p> <p>18-2564 18-2564-9① JUNTA IMPULSOR Alpha I - Generation 2 Reemplaza: 27-430331</p>

 <p>18-0950 JUNTA IMPULSOR ALOJAMIENTO Reemplaza: 27-88046 224 CID</p>	<p>Pack de 2</p>  <p>18-2565 18-2565-9① JUNTA IMPULSOR Alpha I - Generación 2 Reemplaza: 27-430472</p>	<p>Pack de 2</p>  <p>18-2566 18-2566-9① JUNTA IMPULSOR Alpha I - Generación 2 Reemplaza: 27-817277</p>	<p>Pack de 2</p>  <p>18-2823 18-2823-9① JUNTA BOMBA DE AGUA INFERIOR R: 27-32769, 27-19553</p>
<p>Pack de 2</p>  <p>18-2824 18-2824-9① JUNTA BOMBA DE AGUA SUPERIOR Reemplaza: 27-32770, 27-19551</p>	<p>Pack de 2</p>  <p>18-2825 18-2825-9① JUNTA BASE BOMBA AGUA Reemplaza: 27-32771</p>	<p>Pack de 2</p>  <p>18-2826 18-2826-9① JUNTA BASE BOMBA DE AGUA Reemplaza: 27-856101, 27-856704, 27-85610</p>	<p>Pack de 2</p>  <p>18-2914 18-2914-9① JUNTA BOMBA AGUA Reemplaza: 27-856081, 27-85608, 27-32433, 27-30603, 27-8M0090319</p>
<p>Pack de 2</p>  <p>18-2915 18-2915-9① JUNTA BOMBA AGUA Reemplaza: 27-856091, 27-858524, 27-85609, 27-32434, 27-30604</p>	<p>Pack de 2</p>  <p>18-2919 18-2919-9① JUNTA BOMBA AGUA Reemplaza: 27-426311, 27-42631</p>	 <p>18-0388 JUNTA TUBO POWER TRIM Reemplaza: 27-988231, 27-98823</p> <p>18-0342 JUNTA BASE POWER TRIM Reemplaza: 27-476441, 27-47644</p>	<p>Pack de 2</p>  <p>18-0322 18-0322-9① JUNTA PORTA RETÉN Reemplaza: 27-14241, 27-881715, F11101656 GM 5.0L & 5.7L</p>
 <p>18-0898 JUNTA BOMBA ACEITE Reemplaza: 27-56859. Para Ford.</p>	 <p>18-3289 RETÉN DOBLE CAMBIO Reemplaza: 26-864319 Para: Gen II alojamiento superior</p>	 <p>18-2094 RETÉN ACEITE Reemplaza: 26-36143, 26-88416 Para: 120/140(1978-82), 165 (1978-81), 260 (1978-82), 470 (1978-82), 485 (1980-82), 898/228 (1978-82), Alpha I/Gen II (1991 & sup), Blackhawk (1994-95), Bravo I/II/III (1988-98), R/MR/colas Alpha One y Transom (1983-90)</p>	<p>Pack de 2</p>  <p>18-2944 18-2944-9① JUNTA TÓRICA (Quad Ring) Reemplaza: 26-45577, 26-455771</p>
<p>Pack de 2</p>  <p>18-2945 18-2945-9① 18-29451-9① (Pack de 50) JUNTA TORNILLO DRENAJE Reemplaza: 12-20260, 12-19183, 12-191832, 12-191833, F50556, F8077, F8186 Usado en la mayoría de partes inferiores y bombas de agua salada</p>	<p>Pack de 5</p>  <p>18-2948 18-2948-9① ARANDELA DE GOMA Reemplaza: 12-492211, 12-49221, 12-23245</p>	 <p>18-2349 MANGUITO EJE CAMBIO Reemplaza: 23-67370 Para: Ratios 1.47, 1.62, 1.81 & 1.94. Para: Gen II (1998 & sup), (0L100040 & sup) 1/4"</p>	<p>Pack de 2</p>  <p>18-0905 18-0905-9① JUNTA TAPÓN DRENAJE ACEITE Reemplaza: 27-49955, 27-34502, 27-60721, 27-8M0077608</p>

Pack de 2



18-4267
18-4267-9①
ARANDELA
Reemplaza: 12-29395,
12-8M0042641

Pack de 3



18-0681
18-0681-9①
ARANDELA
Reemplaza: 12-32834,
12-8M2001219, 12-93416,
12-934161

Pack de 5



18-0203
18-0203-9①
**ARANDELA ALOJA-
MIENTO TRANSOM**
Reemplaza: 12-35935
Todos Mercruiser Stern
drives 1963-1998

Pack de 5



18-2316
18-2316-9①
ARANDELA VARILLA CAMBIO
Reemplaza: 12-77674, 12-
25410
Usa manguito 18-2349
Para: Ratios 1.47, 1.62, 1.81
& 1.94.For: Gen II (1998 & sup), (0L100040 &
sup) 1/8" Thick



18-0318
ARANDELA
Reemplaza: 12-815472

Pack de 2



18-4270
18-4270-9①
ARANDELA
Reemplaza: 12-36001

Pack de 5



18-2340
18-2340-9①
ARANDELA VARILLA CAMBIO
Reemplaza: 12-31266
Para: #1R/MR (1/16" grosor)

Pack de 2



18-2343
18-2343-9①
ARANDELA TUERCA PIÑÓN
Reemplaza: 12-92721
Para: MR/Alpha/Gen II



TORNILLOS

Ref #	Descripción	O.E. #
18-2361	(Pack. de 2)	10-805763, 10-853163
18-2361-9①	Tornillo montaje parte inf	10-30206
18-3197	Tornillo	10-76156, 10-67373
18-3230	Tornillo	10-816601
18-3231	Tornillo	10-98794



18-3721
18-3721-9①
TUERCA AUTOBLOCANTE
Reemplaza: 11-13439-1,
11-859116
Para: MR/Alpha



18-3236
**CASQUILLO ALINEAMIENTO
ALOJAMIENTO**
Reemplaza: 23-32632
Para: #1R/MR/Alpha



18-4272
TAPA
D.E. 0.870"
Reemplaza: 19-32652



18-4273
TAPA
D.E. 1.250"
Reemplaza: 19-42682



18-2140
**KIT TORNILLO
SOPORTE DE MOTOR**
Para: Mercruiser I



18-2141
**KIT TORNILLOS SO-
PORTE DE MOTOR**
Reemplaza: 10-97934A1
Para: R/MR/Alpha I/ Gen II/Bravo



18-3728
TUERCA AUTOBLOCANTE
Reemplaza: 11-99298,
11-863332



18-3729
TORNILLO
1/2" - 20 x 5 3/8"
Reemplaza: 10-97934, 10-36289



18-2193
SILENT-BLOCK TRASERO
Reemplaza: 33149, 99297A1,
99297A2
Para 120/140 HP S/N 6229717 & SUP:
TODOS 224 CID Blocks; todos 898, 200,
228, 230, 260, 300 & 320 HP; Todos 350-
454 Magnums

① 18-2614D

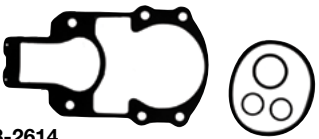

**18-2614
KIT JUNTAS ALPHA ONE
1967-1982**
Reemplaza: 27-64818A1, 27-64818T4,
27-64818Q4, 27-64818A20, 27-64818A4,
27-64818, 27-45821

Para: Todos Bravo

— CONTIENE —

Ref #	Descripción	O.E. #	Cant.
18-2820	Junta	27-64818	1
18-2840	Junta	27-35982	1
18-7153	Aro	25-25439	2
18-7170	Aro	25-33504	1

**18-2615
KITS JUNTAS BRAVO
(Unidad Bravo)**
Reemplaza: 16755, 16755A1, 16755Q1,
16755T1

Para: Todos Bravo

— CONTIENE —

Ref #	Descripción	O.E. #	Cant.
18-2516	Retén	16755	1
18-7198	Aro	25-45710	1
18-7153	Aro	25-25439	2
18-7168	Aro	25-48171	2
18-7105	Aro	25-62705	1
18-7117	Aro	25-35027	1

**18-2617
KIT JUNTAS
Modelo antiguo**
Reemplaza: 27-35996, 27-35996A1

Para: IA/IB/IC y EZ Shift (1964-1966)

— CONTIENE —

Ref #	Descripción	O.E. #
18-2556	Junta	27-35996
18-2840	Junta	27-35982
18-7153	Aro	25-25439
18-7170	Aro	25-33504

① 18-2619-1D



**18-2619-1
KITS JUNTAS ALPHA ONE**
Reemplaza: 27-64818A3, 27-94996Q2, 27-94996T2, 27-94996,
27-94996A1, 27-94996A2, 27-94996A20, 27-64818A2, 27-64818A3

Para: R, MR, Alpha I, Alpha Gen II (1983-Nuevos)

— CONTIENE —

Ref #	Descripción	O.E. #
18-2743	Juntas	27-94996-2
18-2840	Junta	27-35982
18-7153	Aros	25-25439
18-7170	Aros	25-33504
18-7117	Aros	25-35027

**18-2620
KIT JUNTAS COLA**
Reemplaza: 27-54014A1, 27-54014Q1, 27-54014T1, 27-54014

Para: E, H, TR, TRS

— CONTIENE —

Ref #	Descripción	O.E. No.
18-7175	Aro	25-62817
18-2847	Junta	27-54014

① Referencias acabadas en "D" envasadas - Referencias normal no envasada

transmisión Modelo	Desde Nº serie.	Hasta Nº serie.	Juntas transom	Aro Tórico transom	Junta caucho	Aro tórica (2 se necesitan)	Juego Juntas
I	1534570	1684187	—	18-7170	—	18-7153	—
IA	1684188	2062140	18-2556	18-7170	18-2840	18-7153	18-2617
IB	1684633	2062140	18-2556	18-7170	18-2840	18-7153	18-2617
IC	1685240	2065189	18-2556	18-7170	18-2840	18-7153	18-2617
II TR	3377316	4794899	18-2847	18-7175	—	—	18-2620
120	2062141	6225576	18-2820	18-7170	18-2840	18-7153	18-2614
120	6225577	SUP	18-2743	18-7170	18-2840	18-7153	18-2619-1
120	6225577	SUP	18-2743 ③	18-7170	18-2840	18-7153	18-2619-1
140	2062141	6225576	18-2820	18-7170	18-2840	18-7153	18-2614
140	6225577	SUP	18-2743	18-7170	18-2840	18-7153	18-2619-1
140	6225577	SUP	18-2743 ③	18-7170	18-2840	18-7153	18-2619-1
160	2065190	2763441	18-2820	18-7170	18-2840	18-7153	18-2614
165	2763442	SUP	18-2820	18-7170	18-2840	18-7153	18-2614
170	6225577	SUP	18-2743	18-7170	18-2840	18-7153	18-2619-1
170	6225577	SUP	18-2743 ③	18-7170	18-2840	18-7153	18-2619-1
185	6225577	SUP	18-2743	18-7170	18-2840	18-7153	18-2619-1
185	6225577	SUP	18-2743 ③	18-7170	18-2840	18-7153	18-2619-1
190	6225577	SUP	18-2743	18-7170	18-2840	18-7153	18-2619-1
190	6225577	SUP	18-2743 ③	18-7170	18-2840	18-7153	18-2619-1
200	6225577	SUP	18-2743	18-7170	18-2840	18-7153	18-2619-1
200	6225577	SUP	18-2743 ③	18-7170	18-2840	18-7153	18-2619-1
215 E/H	2782203	2915034	18-2847	18-7175	—	18-7153 ①	18-2620
225	3856268	4200499	18-2820	18-7170	18-2840	18-7153	18-2614
228	4782330	6225576	18-2820	18-7170	18-2840	18-7153	18-2614
228	6225577	SUP	18-2743	18-7170	18-2840	18-7153	18-2619-1
228	6225577	SUP	18-2743 ③	18-7170	18-2840	18-7153	18-2619-1
230	6225577	SUP	18-2743	18-7170	18-2840	18-7153	18-2619-1
230	6225577	SUP	18-2743 ③	18-7170	18-2840	18-7153	18-2619-1
233	4200500	SUP	18-2820	18-7170	18-2840	18-7153	18-2614
250	4791300	4898729	18-2820	18-7170	18-2840	18-7153	18-2614
255 TRS	3377316	4203749	18-2847	18-7175	—	—	18-2620
260	4898730	6225576	18-2820	18-7170	18-2840	18-7153	18-2614
260	6225577	SUP	18-2743	18-7170	18-2840	18-7153	18-2619-1
260	6225577	SUP	18-2743 ③	18-7170	18-2840	18-7153	18-2619-1
280 TRS	4203750	4895399	18-2847	18-7175	—	—	18-2620
470	4208730	6225576	18-2820	18-7170	18-2840	18-7153	18-2614
470	6225577	SUP	18-2743	18-7170	18-2840	18-7153	18-2619-1
470	6225577	SUP	18-2743 ③	18-7170	18-2840	18-7153	18-2619-1
485	4893835	SUP	18-2820	18-7170	18-2840	18-7153	18-2614
488	6225577	SUP	18-2743	18-7170	18-2840	18-7153	18-2619-1
488	6225577	SUP	18-2743 ③	18-7170	18-2840	18-7153	18-2619-1
888	3106717	SUP	18-2820	18-7170	18-2840	18-7153	18-2614
898	4782330	6225576	18-2820	18-7170	18-2840	18-7153	18-2614
898	6225577	SUP	18-2743	18-7170	18-2840	18-7153	18-2619-1
898	6225577	SUP	18-2743 ③	18-7170	18-2840	18-7153	18-2619-1
R/MR/Alpha One	6225577	SUP	18-2743	18-7170	18-2840	18-7153	18-2619-1
R/MRAlpha One	6225577	Sup	18-2743 ③	18-7170	18-2840	18-7153	18-2619-1
Bravo (I/II)	B664190	SUP	18-2516	—	—	18-7153	18-2615
TR-TRS	4794900	SUP	18-2847	18-7175	18-2847	18-7153 ②	18-2620

① Sólo cambio hidráulico

② Sólo transmisiones Borg Warner

③ Para alojamientos con válvula antirretorno en el depósito aceite

THE WIDEST VARIETY OF MARINE OILS, LUBES & FILTERS IN THE MARINE INDUSTRY.

OILS & LUBRICANTS

- All blends meet or exceed engine manufacturers' specifications. All Sierra Oils & Lubes "WILL NOT VOID" engine manufacturers' warranties.
- **FC-W** available in:
Premium 10W30, 25W40
Semi Synthetic 10W40, 25W40, 25W50
Full Synthetic 10W30
- **Other 4-Cycle Oils** available in:
Premium Diesel 15W40
Full Synthetic Gas/Diesel SAE30
- **Gear Lubes** available in:
Premium Blend
Hi-Performance Synthetic Blend
Synthetic
- **Premium Marine Bearing Grease**
Available in 15oz tubes

*Also available 16 & 55 gallon drums



FILTRATION

- **FUEL FILTERS/FUEL WATER SEPARATORS**
Sierra is an industry leader in 10-micron filter technology and offers an extensive line of 21-micron filters.
- **OIL FILTERS**
Sierra oil filter designs represent the very best of what we have learned after decades of research and development. No matter what type of boat you drive.



www.sierramarine.com

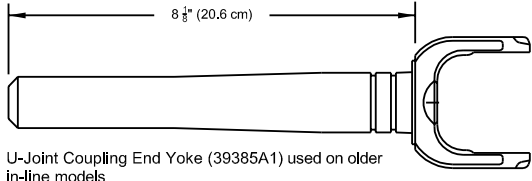
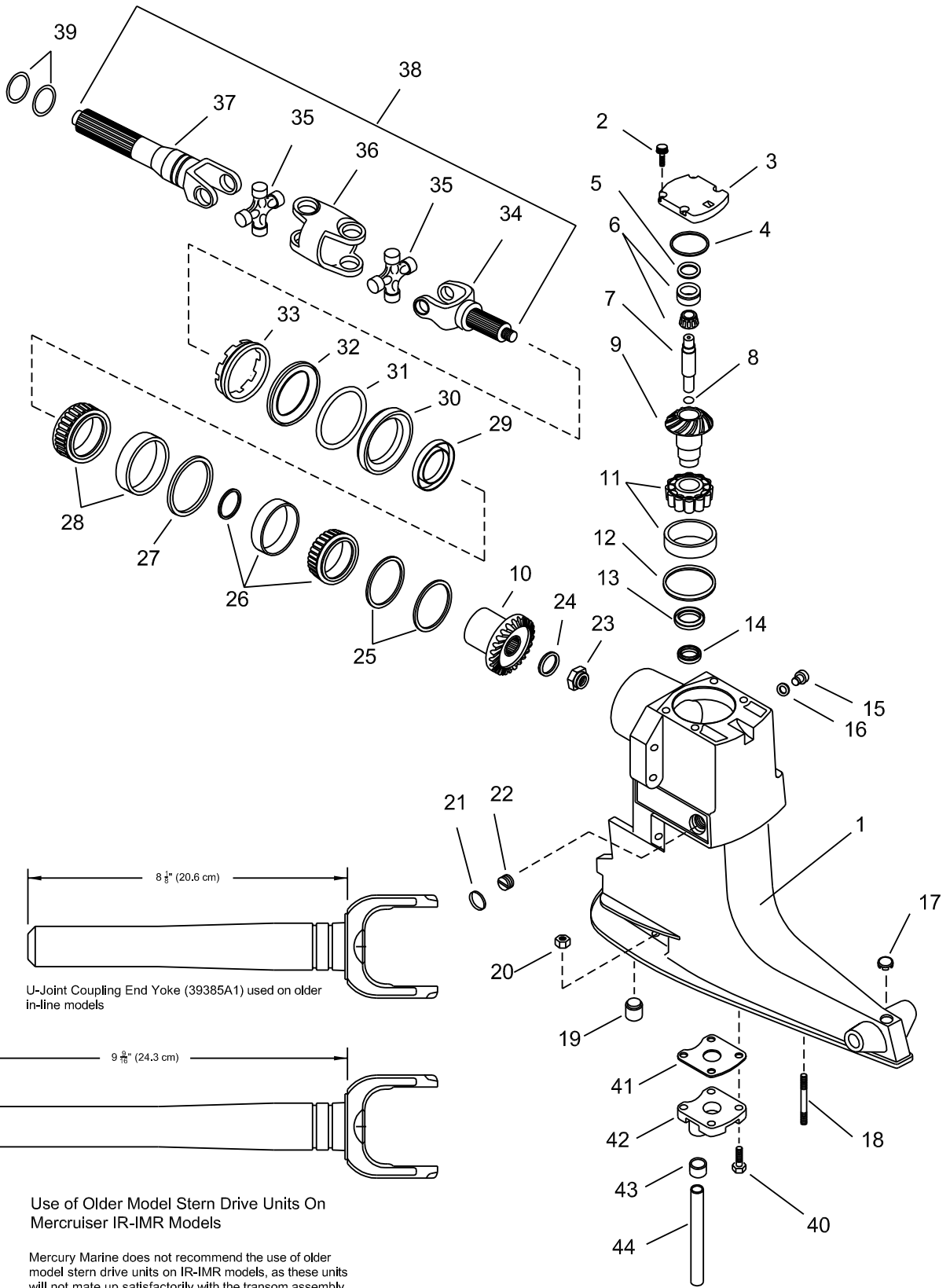

U-Joint Coupling End Yoke (39385A1) used on older in-line models

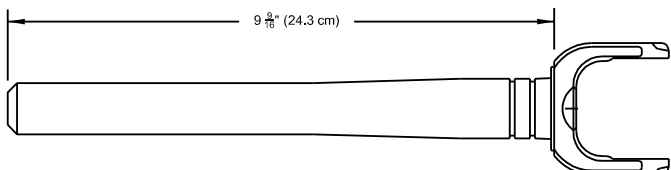

Use of Older Model Stern Drive Units On Mercruiser IR-IMR Models

Mercury Marine does not recommend the use of older model stern drive units on IR-IMR models, as these units will not mate up satisfactorily with the transom assembly. In addition, the older model in-line stern drive units are equipped with U-Joint coupling end yoke (39385A1). This yoke is shorter than yoke (59830A1) used on the IR-IMR stern drive units, and therefore, will not fully engage the engine coupler splines. **Use of an older In-Line model stern drive unit on a IR-IMR model will result in a spline failure to coupling and/or yoke.**

Fig #	Descripción	Ref #	O.E.M. #	Cant.
1	Carcasa parte superior	N/D	1547-9412A18	1
2	Tornillo tapa superior	18-3231	10-98794	4
3	Tapa superior	18-2381	94998A2	1
4	Aro tórico superior	18-7161	25-32546	1
5	Grueso para eje	18-2283	15-45691A1	1
6	Rodamiento tapa	18-1165	31-61100A1	1
7	Eje vertical	18-2179	45-55796	1
8	Aro tórico eje vertical	18-7445	25-55801	1
9./10.	Juego de piñones			
	1.5:1	18-2201	43-18410A2, 46-18411A2	1
	Kit de reparación	18-2256	43-803116T1	1
	1.65:1	18-2203	43-45814A5	1
	Kit de reparación	18-2257	43-803112T1	1
	1.84:1	18-2204	43-75325A3	1
	Kit de reparación	18-2258	43-803114T1	1
	1.98:1	18-2205	43-55778A3	1
	Kit de reparación	18-2259	43-803101T1	1
11	Rodamiento cónico	18-1161	31-35990A1	1
12	Kit de grueso eje vertical	18-2293	15-36178A1	1
13	Retén aceite del alojamiento vertical	18-2049	26-32511	1
14	Retén del alojamiento del eje inferior	18-2056	26-96503	1
15	Tapón de ventilación	18-2244	10-79953A2	1
16	Junta tapón de ventilación	18-2945	12-19183, 12-20260	1
17	Tapón tornillo ánodo de timón	18-3232	19-47579	1
18	Espárrago unión carcasa	N/D	16-56295	2
19	Casquillo carcasa	18-3236	23-32632	1
20	Tuerca espárrago carcasa	18-2362	11-13439-1	3
21	Tapón			
	(7/8" OD)	18-4272	19-32652	1
	(1 1/4" OD)	18-4273	19-42682	1
22	Tapón	18-4265	22-428611	1
23	Tuerca de piñón	18-3713	11-22339	1
24	Arandela de tuerca de piñón	18-3712	12-45810	1
25	Kit de gruesos eje	18-2292	15-35980A1	1
26	Kit de rodamiento	18-1160	31-35988A2, A12	1
27	Espaciador (Incluido en el kit)	18-1160	31-35988A2, A13	1
28	Kit de rodamiento (Incluido en el kit)	18-1160	31-35988A2, A13	1
29	Retén aceite	18-2003	26-64893	1
30	Porta retén	18-0577	66081A2	1
31	Aro tórico	18-7169	25-70937	1
32	Arandela tuerca eje	18-4296	35983	1
33	Tuerca eje cardan	18-3752	816811-1	1
34	Eje trasero cardan	18-2125	46020T	1
35	Cruceta cardan	18-2104	75832A2	1
36	Núcleo carda	18-2128	39383T	1
37	Eje cardan delantero	18-2146	59830A1	1
38	Cardan completo	18-9218	59830A5	1
39	Aro tórico	18-7153	25-25439	2
40	Tornillo	18-3229	10-28668	4
41	Junta	18-0894	27-55810	1
42	Tapa (se vende como conjunto incluye 40-44)	18-3219	42724A3	1
43	Junta bomba agua	18-3110	26-38970	1
44	Tubo de agua	18-3220	32-54236	1

I/-R/MR/ALPHA ONE

Componentes parte superior (Típico)

MERCURISER

AR Se requiere

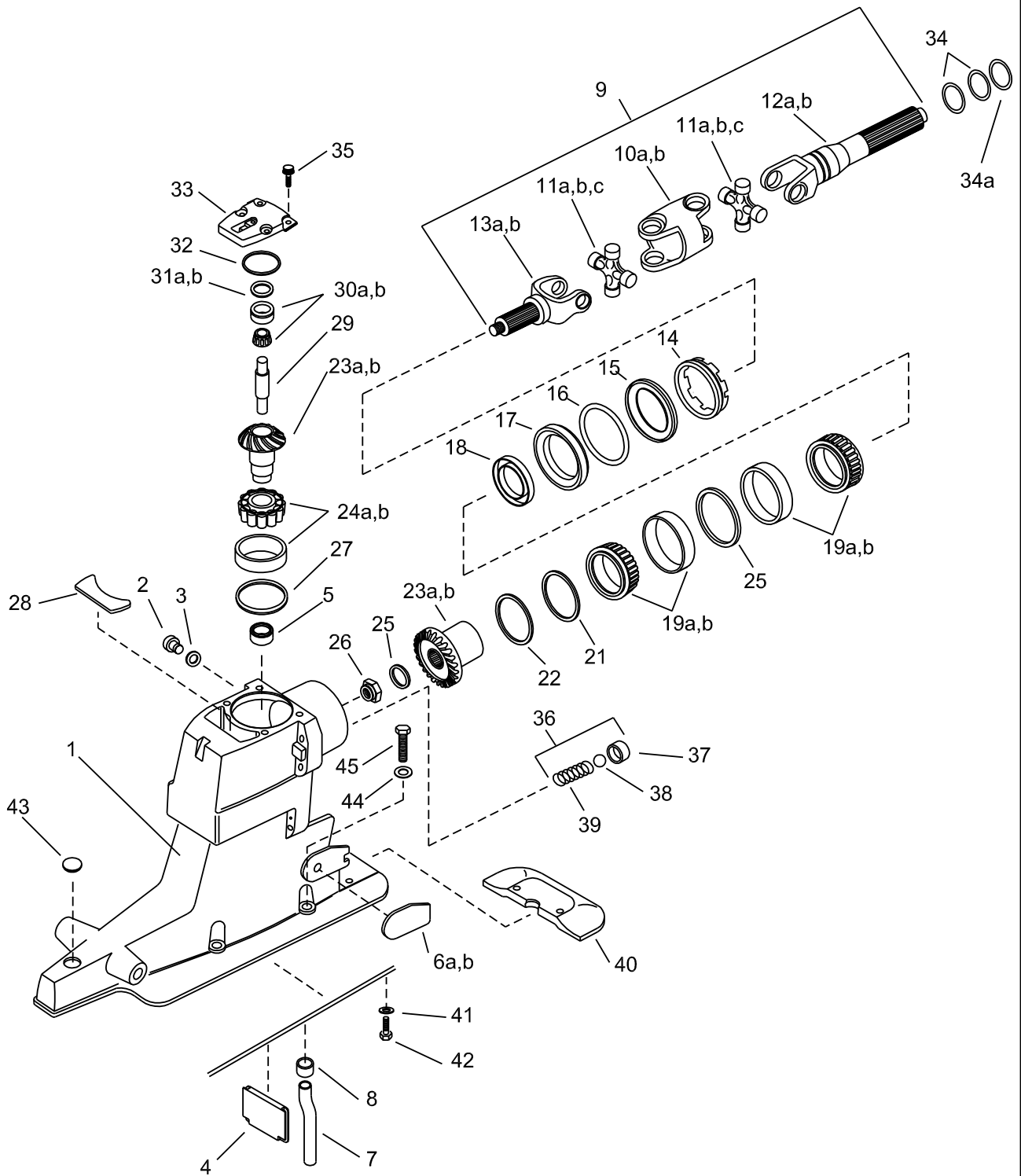

Fig #	Descripción	Ref #	O.E.M. #	Cant.	Fig #	Descripción	Ref #	O.E.M. #	Cant.	
1	Carcasa superior (OL100009 & SUP)	18-2411	1547-861063A 4	1		Kit reparación	18-2364	43-803119T 1	1	
						1.84:1/ 1.81:1 Juego engrajes sup (Dientes... 17/19)	18-2204	43-75325A3	1	
2	Tornillos	18-2244	10-79953A2	1						
3	Arandela	18-2945	12-19183, 12-20260	1		Kit reacondicionamiento	18-2258	43-803114T 1	1	
						Kit reparación	18-2365	43-803120 T 1	1	
4	Separador escape	N/D	815932	1						
5	Retén aceite	18-2056	26-66302	AR		1.98:1/ 1.94:1 Juego engranajes sup (dientes... 20/24)	18-2205	43-55778A3	1	
6a	Tapa babor	NSS	814386	1		Kit de reacondicionamiento	18-2259	43-803101T 1	1	
6b	Tapa estribor	NSS	814387	1		Kit reparación	18-2363	43-803118T 1	1	
7	Tubo agua	18-3221	32-860220	1	23a	Kit unidad superior (OL100009 & SUP)				
8	Retén	NSS	26-88397	1						
9	Eje transmisión (OK999999 & post)	18-9218	814819A2	1		1.47:1 Juego engranajes sup (dientes... 20/22)	18-6351	43-853641A2	1	
						Kit reparación	18-6351K	43-803103T 1	1	
10a	Rótula cardan (diseño antiguo)	18-2128	343831, 39383T	1		1.62:1 & 2.0:1 Juego engranajes sup (Dientes... 24/24)	18-6350	43-853640A2	1	
10b	Rótula cardan	NSS	865503T	1						
11	Cruceta cardan					Kit reparación	18-6350K	43-803104T 1	1	
11a	D469859 - F679999 (diseño antiguo)	18-2174	75832A2	2		1.81:1 Juego engranajes sup (Dientes... 17/19)	18-6353	43-853643A2	1	
11b	F680000- OK999999 (Diseño antiguo- permalube)	18-2097	8055361,805536A1 805536A2	2		Kit reparación	18-6353K	43-803105T 1	1	
11c	OL100009 & SUP (GKN Serie)	18-6406	865493A01	2		1.94 & 2.4:1 Juego engranajes (dientes... 20/24)	18-6352	43-853642A2	1	
12a	Eje largo cardan (OK999999 & post)	18-2146	59830A1	1		Kit reparación	18-6352K	43-803106T 1	1	
12b	Eje delantero cardan (OL100009 & SUP)	18-6405	865491A01	1	24	Cojinetes (All but 1.47:1 ratio)	18-1161	43-803106T 1	1	
					24a	Cojinetes (1.47:1 Ratio only)	18-1142	31-32573A 1	1	
13a	Eje corto cardan (OK999999 & post)	18-2125	46020T	1	25	Arandela	18-3712	12-45810	1	
					26	Tuerca	18-3713	11-22339	1	
13b	Eje trasero cordan (OL100009 & SUP)	18-6403	865492T	1	27	Kit Gruesos	18-2293	15-36178A1	1	
14	Tuerca eje cordan	18-3752	816811-1	1	28	Tapón	NSS	861738	1	
15	Aro	18-4296	35983	1	29	Eje sup (F680000 & Sup)	18-2324	45-55796-1	1	
16	Aro tórico	18-7169	25-70937	1	30	Rodamiento				
17	Porta retén (Set)	18-0577	66081A2	1	30a	F680000 & SUP (rodamiento peg)	18-1179	31-32575A1	1	
18	Retén aceite	18-2003	26-68493	1	30b	D494569 - F679999 (rod.grande)	18-1165	31-61100A1	1	
19	Kit de rodamiento (D469859 - K999999)	18-1160	31-35988A2, A12	1		31	Kit Gruesos			
						31a	D494569 -F679999	18-2283	15-45691A1	1
19a	Kit de rodamiento (OL100009 & SUP)	18-1182	31-30894A 15	1		31b	F680000 & SUP	18-2282	15-32563A1	1
						32	Aro	18-7161	25-32546	1
20	Espaciador (Incluye con 18-1160)	18-1160	31-35988A2, A12	AR	33	Tapa superior (F680000 & Sup)	18-2382	828692A1	1	
20a	Espaciador (Incluye con 18-1182)	NSS	23-853649A 1	AR		34	Aro	18-7153	25-25439	2
						34a	Aro	18-7117	25-35027	1
21	Aro Kit	18-2292	15-35980A1	1	35	Tornillos	18-3231	10-98794	4	
22	Espaciador Spacer	18-2296	15-71013	1	36	Kit válvula	18-2715 KIT	24-17997A1	1	
23	Kit unidad superior (OD469859-OK999999)					37	Retén aceite (Incluido en Kit)	NSS	—	1
						38	Bola (Incluido en Kit)	NSS	—	1
	1.5:1/ 1.47:1 Juego engranajes sup (dientes... 20/22)	18-2201	43-18410A2, 43-18411A2	1		39	Muelle	NSS	—	1
						40	Anodo	025845	821629A1	1
	Kit reacondicionamiento	18-2256	43-803116T 1	1	41	Arandela de cierre	N/D	13-78968	2	
	Kit reparación	18-2358	43-803102T 1	1	42	Tornillos	18-3229	10-28668	2	
	1.65:1/ 1.62:1 Juego engranajes sup (Dientes... 24/24)	18-2203	43-45814A5	1		43	Tapón	N/D	19-824928	1
						44	Arandela	18-4858-9	12-45176	4
	Kit reacondicionamiento	18-2257	43-803112T 1	1	45	Tornillo	18-3230	10-816601	4	

AR Se requiere

NSS No se vende por separado

N/D No disponible

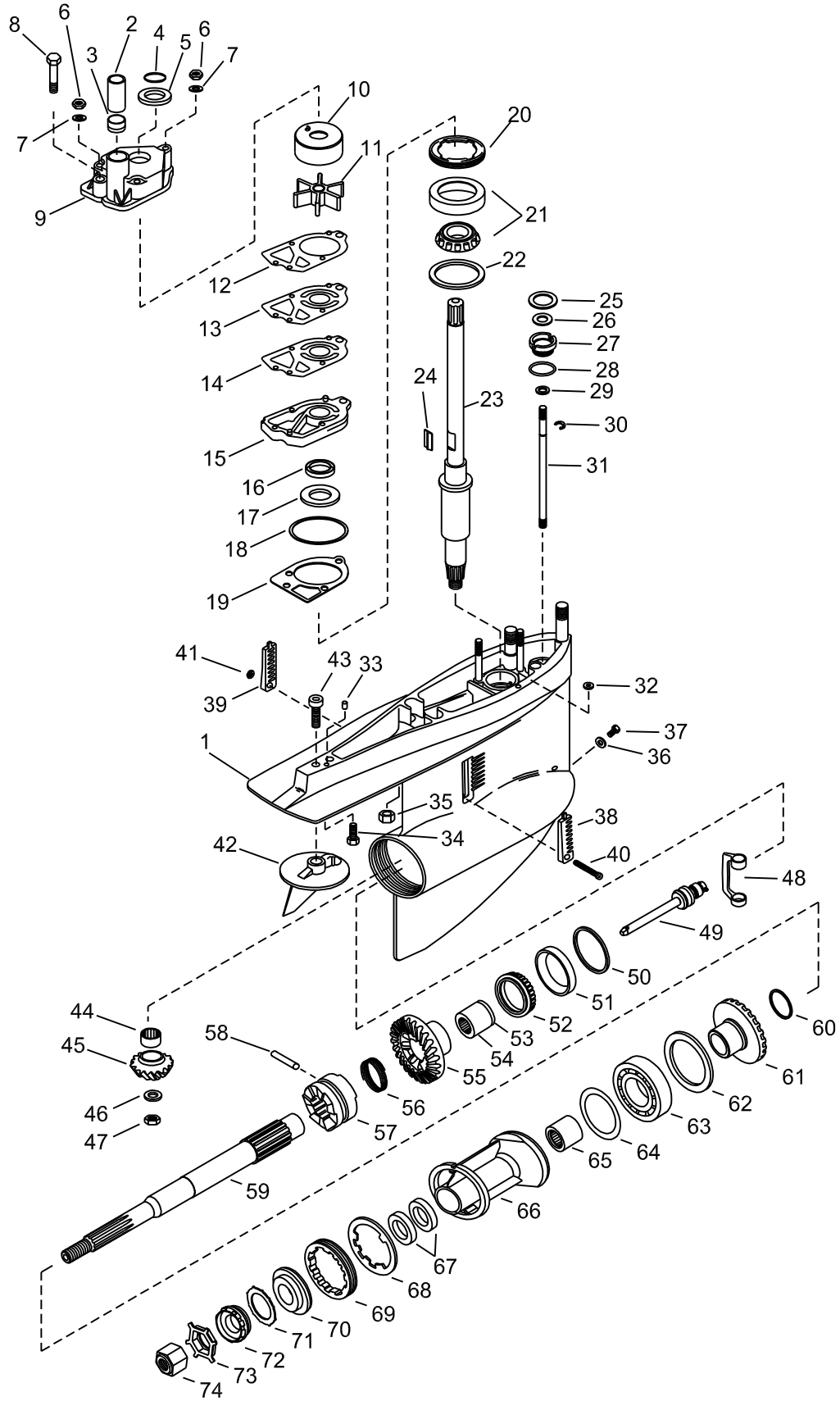
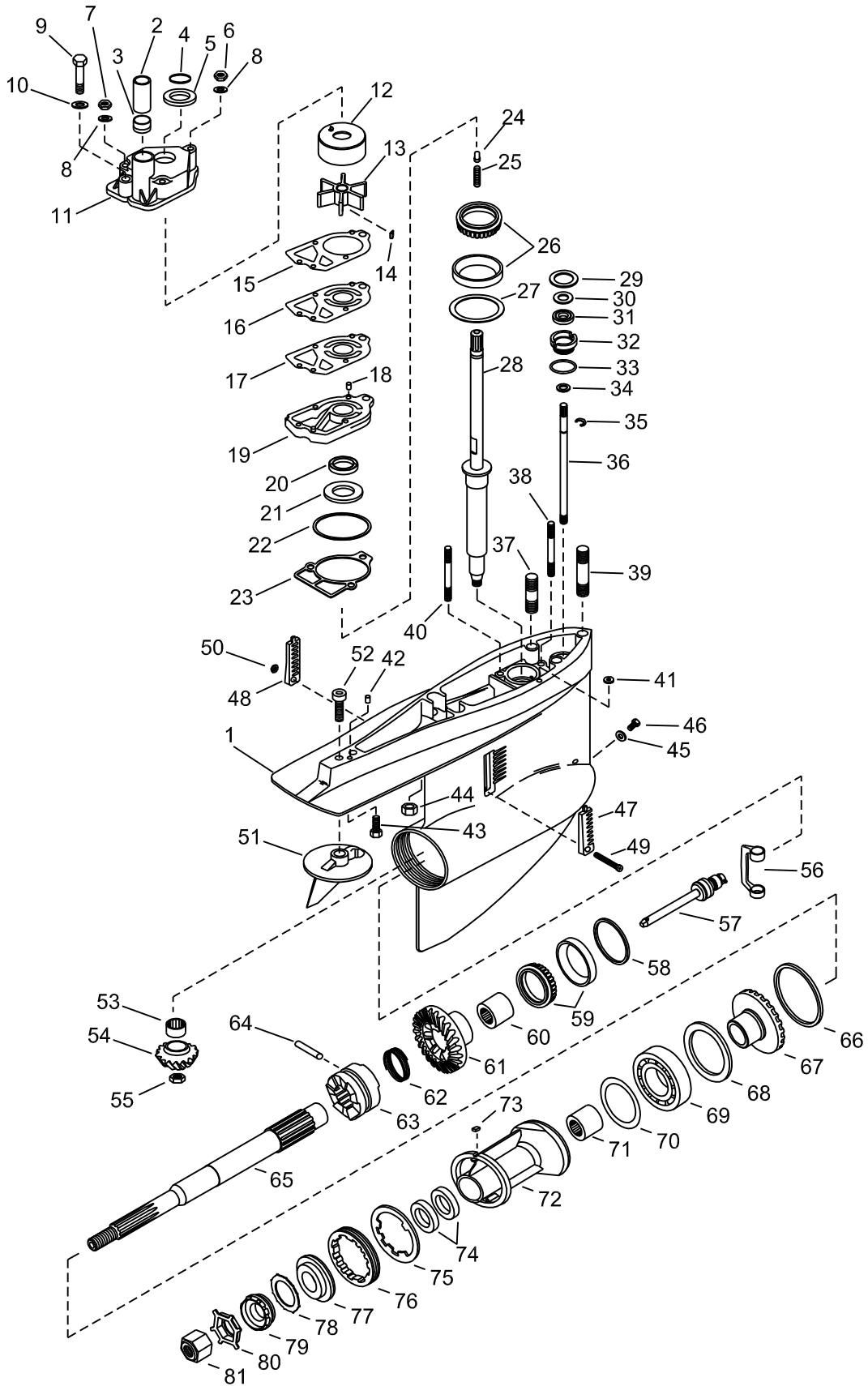

Fig #	Descripción	Ref #	O.E.M. #	Cant.	Fig #	Descripción	Ref #	O.E.M. #	Cant.
1	Caja engranajes	18-2401	1623-8951A37	1	44	Cojinete agujas	18-1117	31-42647A1	1
2	Tubo guía agua	18-3109	23-29804	1	45	Kit piñones parte inferior Alpha	18-2206	43-17064A2, 43-17064A3, 43-42934	1
3	Casquillo bomba agua	18-3110	26-38970	1					
4	Aro tórico eje superior	18-7158	25-30613	1					
5	Goma	18-7426	25-30271	1					
6	Tuercas apriete (5/16-24)	N/D	11-13436	1	46	Arandela	18-2343	22-92721	1
	Acero inoxidable (1/4-28)	N/D	11-13438	2	47	Tuerca piñon	18-3719	11-35921	1
7	Arandela	18-4270	12-36001	3	48	Leva	18-2130	76865	1
8	Tornillo	N/D	10-96411	1	49	Pasador	18-2286	818349A1	1
					50	Grueso	18-2285	15-47397A1	1
9	Alojamiento bomba superior	18-3116	46-96148A1	1	51	Rodamiento cónico	18-1159	31-35928A1	1
10	Acoplamiento	18-3114	48752	1	52	Rodamiento agujas	18-1157	31-30895	1
11	Impulsor 18-3017S	18-3017	47-89984	1	53	Circlip rodamiento	N/D	—	1
12	Junta	18-2915	27-85609-1	1	54	Kit piñones parte inferior alpha	18-2206	43-17064A2, 43-17064A3, 43-42934	1
		18-3117	32435	1					
14	Junta	18-2914	27-85608-1	1	55	Pasador trinquete	18-2348	24-30893	1
					56	Trinquete embrague	18-2202	52-66063	1
15	Base bomba agua	18-3420	46-44292A3	1	57	Pasador	18-2357	24-30893	1
16	Retén aceite (sup)	18-2013	26-16977	1	58	Eje hélice	18-2166	44-66060, 44-6606-3	1
17	Retén aceite (inf)	18-2014	26-89238	1					
18	Aro tórico, bomba agua	18-7176	25-90011	1	59	Eje hélice	18-2166	44-66060, 44-6606-3	1
19	Junta	18-2919	27-42631-1	1	60	Espaciador piñon marcha reverso	N/D	23-824108	1
		18-2915	27-85609-1	1					
20	Retenedor / Cojinete	18-2346	824519	1	61	Kit piñones parte inferior alpha (Engr. reverso-NSS)	18-2206	43-17064A2, 43-17064A3, 43-42934	1
21	Rod. rodillos cónicos eje accion.	18-1143	31-36387A1	1	62	Arandela seguro	18-2342	68100-1	1
22	Kit Gruesos	18-2294	15-42637A1	1	63	Rodamiento a bolas	18-1155	30-88957A1	1
23	Eje	18-2180	45-42634	1	64	Aro tórico	18-7159	25-31534	1
24	Chaveta impulsor bomba de agua	N/D	28-56654	1	65	Cojinete aguja	18-1158	31-30956	1
25	Arandela	18-4267	12-29395	1	66	Cojinete Diabolo	18-2191	73020A-14	1
26	Arandela	18-2340	12-31266	1	67	Retén aceite	18-2002	26-76868	2
27	Casquillo	18-2154	23-30617A2	1	68	Arandela	18-2298	14-18323	1
28	Aro tórico	18-7153	25-25439	1	69	Tuerca	18-3751	79448	1
29	Arandela	NSS	12-27880	1	70	Arandela	18-4220	13171, 77987	1
30	Clip retención eje cambio	NSS	53-29641	1	71	Arandela de continuidad	N/D	13-423511	1
31	Eje cambio acero inox	18-2150	77481-1	1	72	Arandela de cierre	18-3714	12-31211A2	1
32	Retén aceite	18-2944	26-45577	1	73	Arandela	18-3200	14-31210, 14-816629	1
34	Tornillo	18-2361	10-30206	1	74	Tuerca	18-3700	11-52707	1
		18-2362	11-13439-1	2					
35	Tuerca	18-2362	11-13439-1	2					
36	Junta	18-2945	12-19183,	1					
			12-20260						
37	Conector	18-2244	10-79953A2	1					
38	Rejilla (estribor)	18-3199	93423-1	1					
39	Rejilla babor	118-3198	93424-1	1					
40	Tornillo	18-3197	10-76156	1					
41	Tuerca	18-2344	11-45812	1					
42	Ánodo timón	009354	31640A1	1					
43	Tornillo	18-6245	10-32470	1					

N/D No disponible

NSS No se vende por separado



MIRAR PÁGINAS 162 a 164 PARA COLAS DE REPUESTO COMPLETAS

Fig #	Descripción	Ref #	O.E.M. #	Cant.	Fig #	Descripción	Ref #	O.E.M. #	Cant.
1	Caja engranajes inferior	N/D	1623-5356A4	1	42	Pasador	N/D	17-35973	2
2	Tubo guía agua	18-3109	23-29804	1	43	Tornillo	18-2361	10-30206	1
3	Casquillo	18-3110	26-38970	1	44	Tuerca	N/D	11-82671015	2
4	Aro tórico	18-7158	25-30613	1	45	Junta	18-2945	12-19183,	1
5	Goma	18-7426	25-30271	1				12-20260	
6	Tuerca apriete acero inox (5/16-24)	18-3723	11-45592	1	46	Tapón aceite	18-2244	10-79953A2	1
7	Tuerca apriete acer inox (1/4-28)	18-3722	11-20361,	2	47	Rejilla Estribor	N/D	66885	1
			11-35888		48	Rejilla Babor	N/D	66884	1
8	Arandela	18-4275	12-29245	3	49	Tornillo	18-3197	10-76156	1
9	Tornillo	18-3226	10-30720	1	50	Tuerca	18-2344	11-45812	1
10	Arandela	18-4270	12-36001	1	51	Ánodo timón	009354	31640A1	1
11	Alojamiento bomba superior	18-3116	46-96148A1	1	52	Tornillo	18-6245	10-32470	1
12	Acoplamiento	18-3114	48752	1	53	Cojinete agujas	18-1150	31-92366A1	1
13	Impulsor 18-3017S	18-3017	47-89984	1	54	Piñón reverso	18-2200	23-96084A4	1
14	Chaveta	N/D	28-56654	1	55	Tuerca piñón	18-3719	11-35921	1
15	Junta	18-2915	27-85609-1	1	56	Grapa eje	18-2130	76865	1
16	Platina impulsor	18-3117	32435	1	57	Conjunto Carrete inversor	19755A2	18-2286	1
17	Junta	18-2914	27-85608-1	1	58	Grueso	18-2285	15-47397A1	1
18	Alojamiento	18-3227	17-35973	2	59	Cojinete cónico	18-1159	31-35928A1	1
19	Base bomba agua	18-3417	46-57234A1	1	60	Cijinete agua	18-1157	31-30895	1
20	Retén (sup)	18-2026	26-16977	1	61	Kit unidad inferior	18-2200	23-96084A4	1
21	Retén (inf)	18-2014	26-89238	1	62	Pasador trinquete embrague	18-2348	24-30893	1
22	Aro (2.175 ID) & (2.1091 ID)	18-7176,	25-90011	1	63	Trinquete embrague	18-2202	52-66063	1
					64	Pasador trinquete embrague	18-2348	17-30632	1
23	Junta	18-2826	27-85610-1	1	65	Eje de hélice	18-2166	44-66060,	1
24	Pasador	N/D	17-30545	1			44-66060-3		
25	Muelle	N/D	24-34576	1	66	Grueso	18-2284	15-31535A1	1
26	Cojinete cónico	18-1164	31-53079A1	1	67	Piñón reverso	18-2200	43-96084A4	1
27	Grueso	18-2295	15-57007A	1	68	Aro	18-3759	35915	1
28	Drive Shaft	N/D	45-41939A1	1	69	Ball Bearing	18-1155	30-88957A1	1
29	Arandela	18-4267	12-29395	1	70	Aro tórico	18-7159	25-31534	1
30	Arandela	18-2340	12-31266	1	71	Cojinete de aguja	18-1158	31-30956	1
31	Retén aceite	26-89236	18-2009	1	72	Diabolo	18-2191	73020A14	1
32	Casquillo	18-2154	23-30617A2	1	73	Chaveta	N/D	28-30281	1
33	Aro tórico	18-7153	25-25439	1	74	Retén aceite	18-2002	26-76868	2
34	Arandela	N/D	12-27880	1	75	Arandela	18-2299	14-79447	1
35	Clip retención	18-4295	53-29641	1	76	Tuerca	18-3751	79448	1
36	Eje acero inoxidable	18-2150	77481-1	1	77	Arandela	18-4220	13171, 77987	1
37	Tachon (1-31/32")	N/D	16-56298	2	78	Arandela de continuidad	NSS	13-423511	1
38	Tachon (3 - 3/8")	N/D	16-562972	1	79	Arandela de cierre	18-3714	12-31211A2	1
39	Tachon (3 - 3/16")	N/D	16-46911	1	80	Arandela	18-3200	14-31210,	1
40	Tachon (3 - 1/4")	N/D	16-69501	2				14-816629	
41	Retén paso aceite	18-2944	26-45577	1	81	Tuerca	18-3700	11-52707	1

AR Se requiere

NSS No se vende por separado

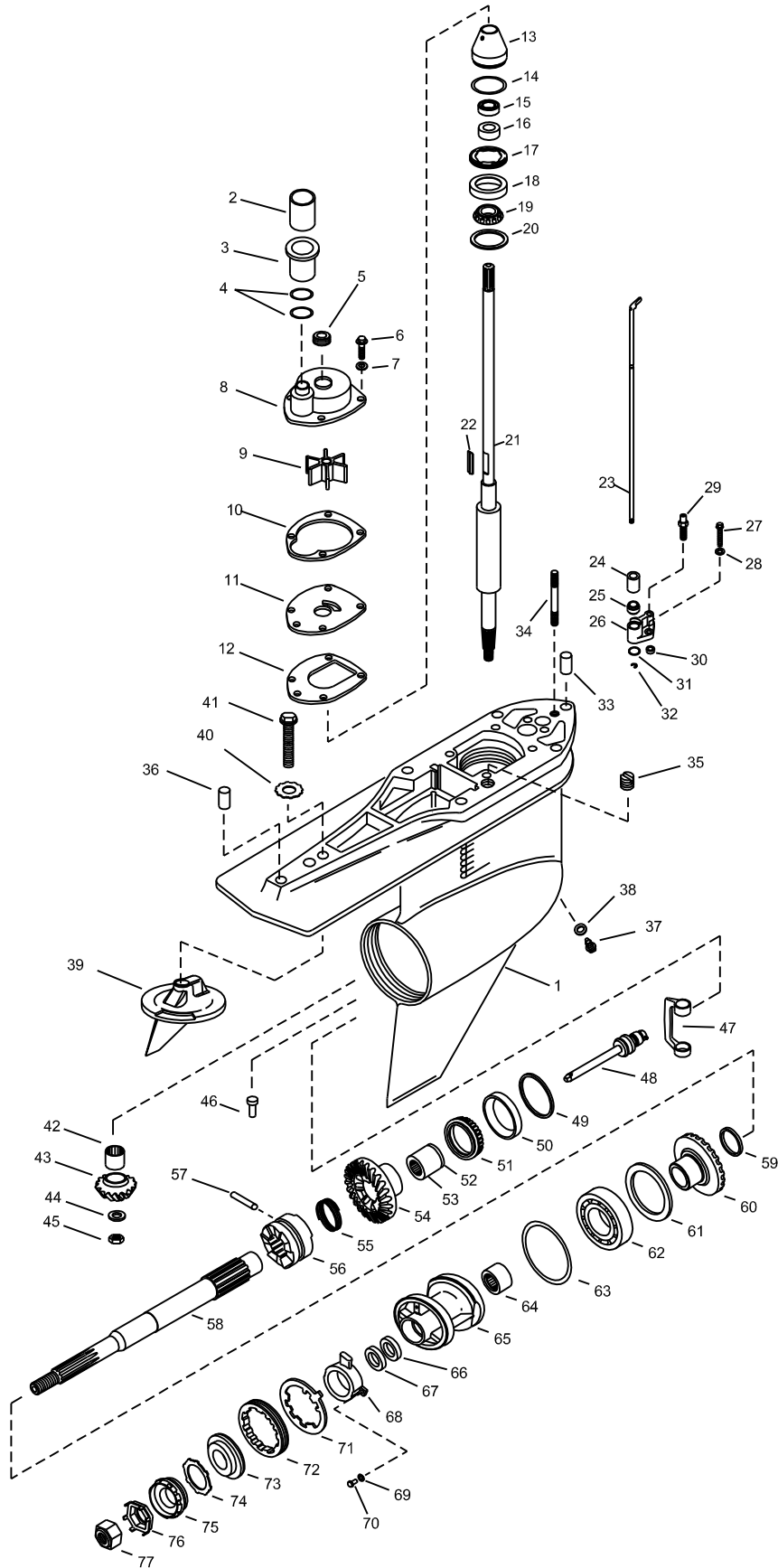

MIRAR PÁGINAS 162 a 164 PARA COLAS DE REPUESTO COMPLETAS

Fig #	Descripción	Ref #	O.E.M. #	Cant	Fig #	Descripción	Ref #	O.E.M. #	Cant
1	Carcasa	18-2415	623-815822A36	1	37	Tornillo drenaje	18-2375	22-67892A1	1
2	Manguito casquillo	—	23-816573	1	38	Junta	18-2945	12-19183	1
3	Acoplamiento	18-3151	816597A1	1	39	Ánodo timón	009467	76214A5	1
4	Aro tórico	18-7420	25-21836	2	40	Arandela, ánodo montaje	—	13-806210	1
5	Retén	18-2599	26-816575A2	1	41	Tornillo, ánodo montaje	—	10-806327	1
6	Tornillo, 10-32 X 5/8	NSS	10-816928	4	42	Cojinete piñón	18-1117	31-42647A1	1
7	Arandela	NSS	13-69432	4	43	Piñón	18-2206	43-828072A2	1
8	Cuerpo bomba de agua	18-3147	817275A1	1	44	Arandela	18-2343	12-92721	1
9	Impulsor 18-3056S	18-3056	47-43026-2	1	45	Tuerca	18-3719	11-35921	1
10	Junta	18-2563	27-817277	1	46	Pin	—	17-37972-1	1
11	Platina desgaste	18-3122	817276	1	47	Leva	18-2130	76865	1
12	Junta	18-2564	27-43033-1	1	48	Pasador	18-2286	818349A1	1
13	Retén	18-2354	821759A2	1	49	Grueso	18-2285	15-47397A1	1
14	Aro tórico	18-7176	25-90011	1	50 & 51	Cojinete	18-1159	31-35928A1	1
15	Retén	18-2013	26-16977	1	52	Clip retenedor	NSS	—	1
16	Retén	18-2014	26-89238	1	53	Cojinete agujas	18-1157	31-30895	1
17	Tuerca	18-2346	824519	1	54	Piñón	18-2206	43-828072A2	1
18 & 19	Cojinete	18-1143	31-36387A1	1	55	Muelle	18-2348	24-30893	1
	(1.50-1.65 Ratio)				56	Trinquete embrague	18-2202	52-824112	1
	Cojinete	18-1193	31-33138A1	1	57	Bulón trinquete	18-2357	17-30632	1
	(1.47-1.62 Ratio)				58	Eje hélice	18-2166	44-824110	1
20	Grueso	18-2294	15-42637A1	1	59	Espaciador	—	23-824108	1
21	Eje (1:47 & 1:62)	18-2331	45-853648	1	60	Piñón	18-2206	43-828072A2	1
	Eje (1:50 & 1:65)	18-2261	45-816919	1	61	Arandela	18-2342	681001	1
	Eje (1:84 & 1:98)	—	45-816472	1	62	Rodamiento bolas	18-1155	30-88957A1	1
	Antiguos usar con:				63	Aro tórico	18-7159	25-31534	1
22	Impulsor chaveta	18-3293	28-43037	1	64	Cojinetes	18-1158	31-30956	1
23	Eje	18-2320	815919A1	1	65	Cojinete diablo	18-2376	818763A10	1
24	Casquillo	18-2349	23-67370	1	66	Retén	18-2002	26-14077	1
25	Retén	18-2009	26-89236	1	67	Retén	18-2076	26-12224	1
26	Alojamiento retén	18-2353	23-815921A21	1	68	Ánodo	18-6093	806105A1	1
27	Tornillo, 10-32 X 5/8	NSS	10-806290	2	69	Tornillos	—	13-69432	2
28	Arandela	NSS	13-69432	2	70	Arandela de seguridad	—	10-806290	2
29	Conector velocímetro	—	NSS	1	71	Arandela	18-2298	14-18323	1
30	Aro tórico	18-7440-1	25-36318	1	72	Tuerca cierre	18-3751	79448	1
31	Aro tórico	18-7440-1	25-36318	1	73	Arandela	18-4220	13171	1
32	Aro retenedor	18-4295	53-29641	1	74	Arandela de continuidad	NSS	13-42351-1	1
33	Pin centrador	—	17-43044	1	75	Arandela	18-3714	12-31211A2	1
34	Tachon	—	16-57984	1	76	Arandela cierre	18-3200	14-31210	1
35	Retén	18-2944	26-45577	1	77	Tuerca hélice	18-3700	11-52707	1
36	Pin centrador	—	17-43044	1		Kit retenes (No dibujado)	18-2646-1	26-816575A3	1

NSS No se vende por separado



18-2292
KIT DE GRUESOS
Transmisión
Reemplaza: 15-35980A1
Contiene (1) cada
.002, .003, .005, .006, .010, .025
Para: Mercuriser Vazer



18-2293
KIT DE GRUESOS
RODAMIENTO SUPERIOR
Reemplaza: 15-36178A1, 15-36178A02,
15-39899A1, 15-23097A1
Contiene (1) cada .002, .003, .015
(2) cada .010
Para: Mercuriser Vazer

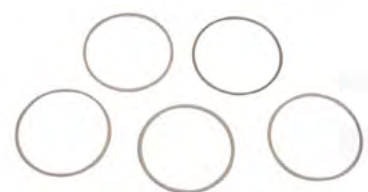

18-2294
KIT DE GRUESOS
Rodamiento inferior del eje
Reemplaza: 15-8M0063267, 15-42637A1
Contiene (1) cada
.002, .003, .005, .010, .020
Para: Mercuriser Vazer



18-2295
KIT DE GRUESOS
Rodamiento inferior del eje
Reemplaza: 15-57007A1,
15-33143A1
Contiene (1) cada
.002, .003, .005, .010, .020
Para: Mercuriser Vazer

GRUESOS		
REF #	TAMAÑO	O.E. #
*18-2282	Kit	15-32563A1 Para: Mercuriser Vazer
*18-2283	Kit	15-45691A1
*18-2284	Kit	15-31535A1
*18-2285	Kit	15-35931A1, 15-47397A1
18-2296	.055	15-71013, 15-45811

*18-2282 (1) .002, .003, .005, .010, .025
*18-2283 (1) .002, .003, .005, .010
*18-2284 (1) .002, .003, .005, .010, .020
*18-2285 (1) .002, .003, .005, .010, .020



REF	TAMAÑO	O.E. #
18-0208	.208	23-1761515 ⑥
18-0210	.210	23-1761516 ⑥
18-0212	.212	23-1761517 ⑥
18-0214	.214	23-1761518 ⑥
18-0216	.216	23-1761519 ⑥
18-0218	.218	23-1761520 ⑥
18-0230	.230	23-1761526 ⑥
18-0222	.222	23-1761522 ⑥
18-0224	.224	23-1761523 ⑥
18-0226	.226	23-1761524 ⑥

APLICACIÓN KITS DE GRUESOS

HP	Número serie	Rodamiento a kit tapa superior	Alojamiento eje	Transmisión	Espaciador transmisión	Alojamiento piñones	Piñón marcha atrás	Piñón adelante
120/140	2062141 hasta 2791956	18-2282 ②	18-2293	18-2292	18-2296	18-2295	18-2284 ⑤	18-2285
120/140	2791957 hasta 4893634	18-2283 ④	18-2293	18-2292	18-2296	18-2295	18-2284 ⑤	18-2285
120/140	4893635 hasta 6225576	18-2283	18-2293	18-2292	18-2296	18-2295	—	18-2285
160	2065190 hasta 2763441	18-2282 ②	18-2293	18-2292	18-2296	18-2295	18-2284 ⑤	18-2285
165	2763442 hasta 4890459	18-2283 ④	18-2293	18-2292	18-2296	18-2295	18-2284 ⑤	18-2285
165	4890460 & SUP	18-2283	18-2293	18-2292	18-2296	18-2295	—	18-2285
888	3106717 & SUP	18-2283 ③	18-2293	18-2292	18-2296	18-2295	18-2284 ⑤	18-2285
898/228	4782330 hasta 4898729	18-2283	18-2293	18-2292	18-2296	18-2295	18-2284 ⑤	18-2285
898/228	4898730 hasta 6225576	18-2283	18-2293	18-2292	18-2296	18-2295	—	18-2285
225-S	3856268 hasta 4200499	18-2283	18-2293	18-2292	18-2296	18-2295	18-2284 ⑤	18-2285
233	4200500 & SUP	18-2283	18-2293	18-2292	18-2296	18-2295	18-2284 ⑤	18-2285
250	4791300 hasta 4898729	18-2283	18-2293	18-2292	18-2296	18-2295	18-2284 ⑤	18-2285
260	4898730 hasta 6225576	18-2283	18-2293	18-2292	18-2296	18-2295	—	18-2285
470	4208730 hasta 4893934	18-2283	18-2293	18-2292	18-2296	18-2295	18-2284 ⑤	18-2285
470	4893835 hasta 6225576	18-2283	18-2293	18-2292	18-2296	18-2295	—	18-2285
485	4893835 & SUP	18-2283	18-2293	18-2292	18-2296	18-2295	—	18-2285
R/MR/Alpha One	6225577 & SUP (R)	18-2283	18-2293	18-2292	18-2296	18-2295	—	18-2285
R/MR/Alpha One	6225577 & SUP (MR)	18-2283	18-2293	18-2292	18-2296	18-2294	⑥	18-2285
Alpha Gen II	D494569 hasta F679999	18-2283	18-2293	18-2292	18-2296	18-2294	⑥	18-2285
Alpha Gen II	F680000 & SUP	18-2282		18-2293	18-2292	18-2296	18-2294⑥	—

② S/N #2187468 & Inf. usar 18-2293 ③ S/N #4433200 & SUP sólo ④ S/N #4530702 & SUP sólo ⑤ Kit ⑥ Sólo contra rotación

18-2400
PARTE INFERIOR
Reemplaza: 1623-815822A53,
1623-815822A5,
1623-815822A32,
1623-815822A3
Para: Ratios 1.47, 1.62, 1.81 & 1.94
Para: Gen II (1998 & sup) 0L100040
& sup



18-2411
ALOJAMIENTO
PARTE SUPERIOR
Reemplaza: 1547-861063A4
Para: Gen II superior (1998-sup), 0L100040-sup, 1.47:1 Ratio/Gen II superior (1998-sup) 0L100040-sup, 1.62/2.00:1 Ratio's/Gen II superior (1998-sup), 0L100040-sup, 1.81:1 Ratio/Gen II superior (1998-sup), 0L100040-sup, 1.94/2.40:1 Ratios
Usado con: 18-2416, 18-2417, 18-2418, 18-2419 Carcasas superiores completas





18-2415
ALOJAMIENTO
Reemplaza: 1623-815822A36
Para: Ratios 1.47, 1.62
Gen II (1998 & sup), (0L100040 & sup)
Usado con: 18-2400 carcasa inferior completa



18-2416
PARTE SUPERIOR
Reemplaza: 1547-815930A6, 1547-861063A12, 1547-815930A16
Para: Alpha Gen II (1991 & SUP) para engranajes ratios 1.47:1, 1.50:1.
Usado con 18-2411 Alojamiento



18-2417
PARTE SUPERIOR
Reemplaza: 1547-815930A5, 1547-861063A10, 1547-815930A15
Para: Alpha Gen II (1991 & SUP) para engranajes ratios 1.62:1, 1.65:1, 2.0:1.
Usado con: 18-2411 alojamiento parte superior



18-2418
PARTE SUPERIOR
Reemplaza: 1547-815930A4, 1547-861063A8, 1547-815930A14
Para: Gen II (1991 & SUP) para engranajes ratios 1.81:1, 1.84:1.
Usado con: 18-2411 Alojamiento



18-2419
PARTE SUPERIOR
Reemplaza: 1547-815930A3, 1547-861063A6, 1547-815930A13
Para: Alpha Gen II (1991 & SUP) para engranajes ratios 1.98:1 y 2.40:1
Usado con: 18-2411 Alojamiento



18-2450
UNIDAD SUPERIOR COMPLETA
Reemplaza: 1547-9412A20, 1547-3917A13, 1547-3917A21, 1547-3917A32, 1547-3917A37, 1547-5523A2, 1547-5523A9, 1547-5523A12, 1547-5523A68, 1547-8265A15, 1547-9412A30, 1547-9412A35
Para: Alpha I
1.5:1/1.47:1



18-2451
UNIDAD SUPERIOR COMPLETA
Reemplaza: 1547-9412A21, 1547-3917A4, 1547-3917A8, 1547-3917A16, 1547-3917A30, 1547-3917A38, 1547-5523A8, 1547-5523A11, 1547-8265A16
Para: Alpha I
1.65:1/1.62:1



18-2452
UNIDAD SUPERIOR COMPLETA
Reemplaza: 1547-9412A22, 1547-5523A67, 1547-8265A17, 1547-9412A36
Para: Alpha I
1.84:1/1.81:1



18-2453
UNIDAD SUPERIOR COMPLETA
Reemplaza: 1547-9412A23, 1547-5523A49, 1547-5523A67, 1547-8265A17
Para: Alpha I
1.98:1/1.94:1

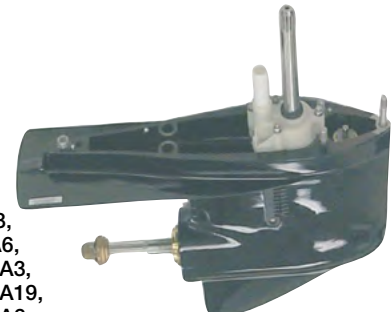

18-2443
PARTE INFERIOR
Reemplaza: 1623-8951A43, 1623-4110A4, 1623-4110A6, 1623-4110A13, 1623-5356A3, 1623-5356A18, 1623-5356A19, 1623-5356A20, 1623-8951A2, 1623-8951A14, 1623-8951A19, 1623-8951A23
Para: R/MR/ALPHA 1

18-2401

CARCASA INFERIOR

Reemplaza: 1623-8951A27,
1623-8951A37, 1623-8951A5, 1623-8951A15

Para: MR/ALPHA Estilo

Tamaño diámetro 3.2635-3.2650. Incluye Rodamiento de rodillos cónicos para los no-tractor 14/28 o 17/28 marchas. Al instalar engranajes nuevos utilice 18-2206-1 kit de engranajes que incluye rodamiento de rodillos cónicos para tractor 18-1156 13/21 marchas.



18-2358

KIT REPARACIÓN UNIDAD SUPERIOR

Reemplaza: 43-803102T1

Para: 20-22 dientes: 1.50:1 (1.47:1)

Sólo para aplicaciones Gen II número de serie hasta OK999999



18-2363

KIT REPARACIÓN UNIDAD INFERIOR

Reemplaza: 43-803118T1

Para: 20-24 dientes: 1.98:1 (1.94/2.40:1)

Sólo para aplicaciones Gen II número de serie hasta OK999999



18-2364

KIT REPARACIÓN UNIDAD SUPERIOR

Reemplaza: 43-803119T1

Para: 24-24 dientes: 1.65:1 (1.62:1)

Sólo para aplicaciones Gen II número de serie hasta OK999999



18-2365

KIT REPARACIÓN UNIDAD SUPERIOR

Reemplaza: 43-803120T1

Para: 17-19 dientes: 1.84:1 (1.81:1)

Sólo para aplicaciones Gen II número de serie hasta OK999999



18-6351K

KIT REPARACIÓN UNIDAD INFERIOR

Reemplaza: 43-803103T1

Para: Gen II (1998 & sup)(S/N OL100040 & sup)

1.47:1 Ratio



18-6352K

KIT REPARACIÓN UNIDAD SUPERIOR

Reemplaza: 43-803106T1

Para: Gen II (1998 & sup)(S/N OL100040 & sup)

1.94:1 y 2.40:1 Ratio



18-6353K

KIT REPARACIÓN UNIDAD INFERIOR

Reemplaza: 43-803105T1

Para: Gen II (1998 & sup)(S/N OL100040 & sup)

1.81:1 Ratio



18-2201

KIT ENGRANAJES SUPERIOR

Reemplaza: 43-18410A2,
43-18411A2, 43-59832A2, 43-59832A4

Incluye: (1) 18-1142

Mercuriser #31-32573A1

(1.5:1 Ratio)

(Engranaje = 22 dientes Engranaje = 20 dientes)

Para mayoría V-8 Drives y Gen II (S/N K999999 & post)

Modelo dirección	Desde. S/N	Hasta. S/N	Modelo dirección	Desde. S/N	Hasta. S/N
225	3856268	4200499	888	3106717	& SUP
260	4898730	6225576	V8R/MR/AlphaOne	6225577	& SUP
898/228	4782330	6225576			



18-2203
KIT ENGRANAJES SUPERIOR
 Reemplaza: 43-45814A5, 43-55765A2, 43-55765A3
 (1.65:1 Ratio) (Engranaje = 24 Dientes Engranaje = 24 Dientes)
 Para: 6 Cil. En línea S/N K999999 & POST



18-2204
KIT ENGRANAJES SUPERIOR
 Reemplaza: 43-75325A3, 43-75325A2
 (1.84:1 Ratio)
 (Engranaje = 17 dientes Engranaje = 19 dientes)
 Para: V-6 and 470/485 (4 Cyl. etc.) y Gen II
 (S/N K999999 & Inf.)



18-2205
KIT ENGRANAJES SUPERIOR
 Reemplaza: 43-55778A3, 43-55766A2, 43-55766A3
 (1.98:1 Ratio)
 (Engranaje = 20 dientes Engranaje = 24 dientes)
 Para: 120/140 (S/N 2791957 & SUP) y Gen II
 (S/N K999999 & inf)



18-6350
KIT ENGRANAJES SUPERIOR
 Reemplaza: 43-853640A2, 43-821823A1
 Para: Gen II superior (1998-sup), 0L100040-sup,
 1.62/2.00:1 Ratios (24-24 dientes)
 Usado con: 18-2417 Carcasa superior completa



18-6351
KIT ENGRANAJES SUPERIOR
 Reemplaza: 43-853641A2
 Para: Alpha I (Gen II) (1998-sup), 0L100040-sup,
 1.47:1 Ratio (20-22 dientes)
 Usado con: 18-2416 carcasa completa superior



18-6352
KIT ENGRANAJES SUPERIOR
 Reemplaza: 43-853642A2
 Para: Alpha I (Gen II) (1998-sup), 0L100040-sup,
 1.94:1, 2.40:1 Ratios (20-24 dientes)
 Para: Mercruiser Vazer
 Usado con: 18-2411 Alojamiento,
 18-2419 Carcasa superior completa



18-6353
KIT ENGRANAJES SUPERIOR
 Reemplaza: 43-853643A2
 1.81 Ratio superior Gear Set, 17-19 dientes
 Para: Alpha I Gen II 1998-sup/0L00040-sup
 Para: Mercruiser Vazer

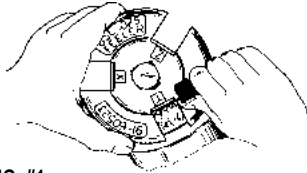

FIG. #1

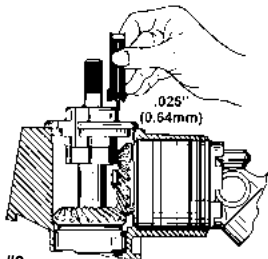

FIG. #2

FIGURAS #1 - #2
 Proporciona dos vistas diferentes del kit de engranajes superior siendo ajustados con las herramientas de instalación.

FIGURAS #3 - #4
 Proporciona las mismas vistas de la instalación del kit de engranajes.

NOTA:
 La instalación no se podrá efectuar correctamente sin la herramienta Mercury.
 Una instalación inapropiada causará fallo de los engranajes. La herramienta .025 de la FIG #2 y FIG #4 está indicado cuando la de .026 no se adapta pero la de .025 si.

Siga paso a paso el manual de instalación. Vea el manual sierra ref. SE-62

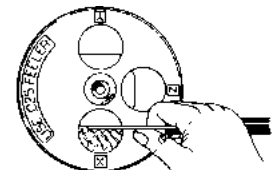

FIG. #3

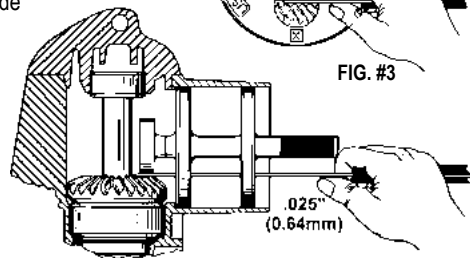

FIG. #4



18-2256
KIT ENGRANAJES SUPERIOR
 Reemplaza: 43-803116T1
 Mayoría V-8 (1.5:1 Ratio)

— CONTIENE —

Ref #	Descripción	O.E. #	cant.
18-2201	kit unidad superior	43-18410A2	1
18-2648	Kit retén	26-32511A2	1
18-2619-1	Juego juntas	27-94996A1	1
18-2820	Junta	27-64818	1
18-2743	Junta	27-94996-2	1
18-1160	Cojinete	31-35988A2	1
18-1165	Cojinete	31-61100A1	1
18-1142	Cojinete	31-35990A1	1

-- CONTIENE --

Ref #	Descripción	O.E. #	Cant.
18-2203	Kit engranajes	43-45814A5	1
18-2648	Kit retén	26-32511A2	1
18-2619-1	Kit juntas	27-94996A1	1
18-2820	Junta	27-64818	1
18-1160	Cojinete	31-35988A2	1
18-1161	Cojinete	31-35990A1	1
18-1165	Cojinete	31-61100A1	1
18-2743	Junta	27-94996-2	1

18-2257
KIT ENGRANAJES SUPERIOR
Reemplaza: 43-803112T1
6 Cil. En línea (1.65:1 Ratio)



-- CONTIENE --

Ref #	Descripción	O.E. #	Cant.
18-2204	Kit engranajes	43-75325A3	1
18-2648	Kit retén	26-32511A2	1
18-2619-1	Kit juntas	27-94996A1	1
18-2820	Junta	27-64818	1
18-1160	Cojinete	31-35988A2	1
18-1161	Cojinete	31-35990A1	1
18-2743	Junta	27-94996-2	1
18-1165	Cojinete	31-61100A1	1

18-2258
KIT ENGRANAJES SUPERIOR
Reemplaza: 43-803114T1
V-6 (470/485) (1.84:1 Ratio)



-- CONTIENE --

Ref #	Descripción	O.E. #	Cant.
18-2205	Kit engranajes	43-55778A3	1
18-2648	Kit retén	26-32511A2	1
18-2619-1	Juego juntas	27-94996A1	1
18-2820	Juntas	27-64818	1
18-1160	Cojinete	31-35988A2	1
18-1161	Cojinete	31-35990A1	1
18-1165	Cojinete	31-61100A1	1
18-2743	Junta	27-94996-2	1

18-2259
KIT ENGRANAJE SUPERIOR
Reemplaza: 43-803101T1
120/140 (1.98:1 Ratio)



18-2125
EJE CARDAN TRASERO
Reemplaza: 39384, 46020, 460201, 46020T, 4602002, 46020002,
Para todos #1/ALPHA Units (S/N 1684188 - OK999999)



18-2146
EJE CARDAN DELANTERO
Reemplaza: 20175, 59830A1, 59830A7
Para todos #1, R, MR, Alpha I, Alpha I Gen II, Bravo & Blackhawk



18-6400
EJE CARDAN TRASERO
Reemplaza: 12784, 12784T
Para: Bravo (OM111207 & post) y Blackhawk



18-6404
ALQJAMIENTO CRUCETA
Reemplaza: 865503T y Superiores



PRONAUTIC
MARINE EQUIPMENT



18-6401
CARDAN COMPLETO
Reemplaza: 12784A10, 12784A4
Para Bravo I, II, III (OB664190 - sup)
(1998-05)



18-9218
CARDAN COMPLETO
Reemplaza: 814819A2, 59830A5, 59829A1
Para todos #1, R/MR/ALPHA Gen II
OK999999 & post (1971-97)



18-2128
RÓTULA CARDAN
Reemplaza: 39383, 39383T, 393831
(Rockwell)
Para IA/IB/IC & EZ, MC-1, R, MR, Alpha One, Gen II
(OL949778 & post), Bravo (OM111207 & post),
MC II & TS



18-1711
CRUCETA CARDAN
Reemplaza: 862132, 862132T
Para: Bravo One, Two, & Three (Todos Ratios), Bravo
One X/Two X, Three X (todos Ratios), Bravo One XR/
XZ(Todos Ratios), Bravo One XR Sportmaster (Todos
Ratios) & Integrated Transom



18-2097
CRUCETA CARDAN
Permalube
Reemplaza: 8055361, 805536A1, 805536A2
Para: Generation II F680000 & SUP



18-2104
CRUCETA CARD.
Heavy Duty
Reemplaza: 75832, 75832A2, 75832T,
758321, 75832T1, 75832A1, 75832A3,
58749, 41431, 36312
Incluye engrasadores rectos y de 90° (Rockwell)
Para todos #1 y ALPHA I Units S/N 1684188-B418818.
También TR/TRS y II SSM.



18-2174
CRUCETA
Heavy Duty
Reemplaza: 36312, 41431, 58749,
75832, 75832T, 75832A1, 75832A2,
75832A3, 758321, 75832T1
Incluye engrasadores rectos y de 90° (Rockwell)
Para unidades ALPHA I S/N B418819 & en adelante.
También para ALPHA I SS & BRAVO



18-6406
KIT CRUCETA CARDAN
Reemplaza: 865496A01, 865493A01,
865510T, 865496A01, 865511T
GKN nuevo estilo con clips exteriores.
Se adapta: Alpha I Gen II OL949779 & SUP, Bravo
OM111208 & SUP
Para: Mercuriser Vazer



18-8311
KIT DE RECONSTRUCCIÓN TRANSOM
Para: Alpha One



18-8312
KIT DE RECONSTRUCCIÓN TRANSOM
Para: Gen II



18-8313
KIT DE RECONSTRUCCIÓN TRANSOM
Para: Bravo



18-21001
COJINETE
Reemplaza: 30-60794A2, 30-60794A4,
30-879194A02
No engrasable
Para: MC-1, R, MR y Alpha(1974-97),
Gen II(1991-97), Bravo I/II/III (1988-95)



18-21006
COJINETE
No engrasable
Reemplaza: 30-862540T1, 30-862540A3,
30-862540A04, 30-879194A01
Para: Gen II (1998-10), Bravo I/II/III & X/XR/XZ (1996-10)



18-21005
RODAMIENTO
Reemplaza: 30-862540A3, 30-862540T1,
30-862540A04, 30-879194A01
Engrasable
Para: Todos Bravos, Alpha One Gen II (1998-sup)



18-21005K
KIT RODAMIENTO Y RETÉN
Reemplaza: 30-862540A3, 30-862540T1,
30-862540A04, 30-879194A01
Engrasable
Contiene (1) cada uno de 18-2094 & 18-21005
Para: Gen II (1998-sup) y todos Bravo



18-2101
RODAMIENTO CARDAN
Reemplaza: 30-36418, 30-36056, 36147
Engrasable
(Enlace correa)



18-2100
RODAMIENTO CARDAN
Reemplaza: 30-60794A4, 30-60794A2,
30-879194A02
Engrasable
(enlace correa)
Para: Mercuriser- 120HP / 140HP
(2791957-6225576) (con indicador de trim), 165HP
(2763442 & sup), 225S (3856268-4200499), 228HP
(4782330 & sup), 233HP (4200500 & sup), 250HP
(4791300 & sup)



18-2100K
KIT RODAMIENTO Y RETÉN
Reemplaza: 30-60794A2, 30-60794A4,
30-879194A02
Engrasable
Contiene (1) cada uno de 18-2094 & 18-21001
Para: 1, R, MR y Alpha (1974-97)



18-7313
PIVOTE
Reemplaza: 98230A1
Para: Mercuriser Alpha/Gen II/Bravo I/II/III & Vazer



18-1705
TORNILLO
Reemplaza: 77123, 77123A1,
65547
(con engrasador) Para transom
Para: Alpha, Alpha Gen II
S/N 0M815638 & inf



18-1706
TORNILLO
Reemplaza: 10-86801
Para rodamiento cardan
Para: Alpha Gen II S/N 0M85639 & SUP
todos los Modelos Bravo con trim sender



18-2381
TAPA PARTE SUPERIOR
Reemplaza: 94998A1, 94998A2,
94998A3, 94998A4
S/N 6225577 & últimos Alpha I, excepto
Gen II



18-2382
TAPA PARTE SUPERIOR
Reemplaza: 828692A1, 18312A3
Para: Gen II S/N F680000 & SUP

APLICACIONES RODAMIENTO

Modelo	Año rango	Núm. Serie	Rodamiento	Modelo	Año rango	Núm. Serie	Rodamiento
II	1963	1534570-1684187	30-32537T	250 / 260	1977-1982	1791300-6225576	18-21001
IA	1964	1684186-1777798	18-2101	R / MR / ALPHA I	1983-1990	6225577 & SUP	18-21001
IB	1964	1684188-1777798	18-2101	ALPHA I SS	1986-1989	A545004 & SUP	18-21001
IC	1964	1684188-1777798	18-2101	ALPHA I GEN II	1991-1997	D469859-K999999	18-21001
EZ-SHIFT	1964	1684188-1777798	18-2101	ALPHA I GEN II	1998-2010	L100040 & SUP	18-21001
120 / 140	1967-1973	2062141-3780849	18-2101	BRAVO I	1988-1995	B664190-F729999	18-21001
120 / 140	1974-1982	3780850-6225576	18-21001	BRAVO II	1988-1995	B664190-F729999	18-21001
470 / 485	1976-1982	4208730-6225575	18-21001	BRAVO III	1988-1995	B664190-F729999	18-21001
160 / 165	1967-1973	2065190-3780849	18-2101	BRAVO I	1996-2010	F730000 & SUP	18-21006
165	1974-1981	3780850 & SUP	18-21001	BRAVO II	1996-2010	F730000 & SUP	18-21006
888	1971-1973	3106717-3784374	18-2101	BRAVO III	1996-2010	F730000 & SUP	18-21006
888	1974-1977	3784375 & SUP	18-21001	X / XR / XZ	1996-2010	F730000 & SUP	18-21006
225 / 233	1974	3856268 & SUP	18-21001	BLACKHAWK	1994-1995	F186717 & SUP	18-21001
898 / 228	1977-1982	4782330-6225576	18-21001	II	1964-1969	1602186-2671321	18-2101



18-2179
EJE TRANSMISIÓN SUPERIOR
Reemplaza: 45-55796



18-2324
EJE TRANSMISIÓN SUPERIOR
Reemplaza: 45-557961
Para: Gen II (S/N F680000 & SUP),
Mercuriser Vazer



18-3713
TUERCA
Reemplaza: 11-22339, 11-
97522, 11-36084, F1348, F1881
5/8" - 18



18-3712
ARANDELA
Reemplaza: 12-45810

 <p>18-3752 TUERCA RETENCIÓN ALOJAMIENTO EJE TRANSMISIÓN Reemplaza: 8168111, 8168112, 66071, 35992</p>	 <p>18-4296 SEPARADOR Reemplaza: 35983 (Alojamiento superior)</p>	 <p>18-0577 ASIENTO RETÉN Reemplaza: 66081A2, 35993A1, 66081A1, 66081A4</p>	 <p>18-3219 KIT REFRIGERACIÓN Reemplaza: 32489, 32489A2, 42724A3 Para: Merc I y Alpha I drives Modelos: I, 1A, 1B, 1C, 1CEZ, 120, 140, 160, 165, 888, 898, 228, 225-S, 233, 250, 260, 470, 485, R, MR, Alpha 18-3229 TORNILLO Reemplaza: 10-28668</p>
 <p>18-2322 EJE INTERMEDIO Reemplaza: 62104, 621041 Para: I y Alpha I</p>	 <p>18-2169 BRAZO DE CAMBIO Reemplaza: 45589A1, 45589A3</p>	 <p>18-3749 EJE SUPERIOR CAMBIO Reemplaza: 816685 Para: Alpha Gen II (1991-98)</p>	
 <p>18-2599 RETÉN Reemplaza: 26-816575A2 Para: ALPHA I GENERATION II</p>	 <p>18-2622 KIT CASQUILLOS ALOJAMIENTO CAMPANA Reemplaza: 23-79373A1, 23-805041A2, 27-45588, 27-79373</p>	 <p>18-3760 KIT COJINETE CAMPANA Reemplaza: 23-806036A1 Para: GEN II Serial # F680000 & SUP</p>	
 <p>18-2161 BRAZO CAMBIO Reemplaza: 45518A1, 45518A2, 45518A3</p>	 <p>18-2170 TORNILLO BRAZO CAMBIO Reemplaza: 10-45590, 10-8M0084649</p>	 <p>18-2162 CORREDERA CABLE CAMBIO CON TORNILLO Reemplaza: 33981, 33981T, 33981T1, 8507521, 8507522</p>	 <p>PRONAUTIC MARINE EQUIPMENT</p>
<p>Pack de 5</p>  <p>18-2163 18-2163-9^① TORNILLO Reemplaza: Mercruiser 10-31700 GLM: 21090 Mallory: 9-72152</p>	<p>Pack de 5</p>  <p>18-2163E-9^① TORNILLO Sólo para cables extreme</p>	 <p>18-2715 KIT VÁLVULA ACEITE Reemplaza: 24-17997A1 Para: Alpha I Generation II y Bravo I, II, y III Drives</p>	 <p>18-2724 GOMA CIERRE TRANSOM Reemplaza: 3713 Para: Alpha Gen II, Todos Bravo</p>

① Precio por pack

— CONTIENE —

Ref #	Descripción	O.E. #	Cant.
18-2619-1	Juego de juntas fueraborda	27-64818A3 27-94996A1,Q2	1
18-2100	Rodamiento	30-60794A2, 30-60794A4	1
18-2161	Brazo cambio	45518A2	1
18-2751	Fuelle unión	60932A4	1
18-2750	Fuelle escape	32734A3, 18654A1	1
18-2753-1	Fuelle cable cambio	74639	1
18-3601	Manguito	32-32461	1
18-3602	Manguito	32-41725-33	1
18-710-16-2	Brida	—	2
18-7314	Abrazadera inox	—	1
18-710-64-2	Abrazadera inox	—	1



**18-2601-1
KIT RETENES TRANSOM**
Reemplaza: 30-803097T1

R, MR, ALPHA 1 (1983-90) S/N 6225577 & SUP
ALPHA 1 SS (1986-89) S/N OA 545004 & SUP
*Cojinete engrasable

— CONTIENE —

Ref #	Descripción	O.E. #	Cant.
18-2100	Rodamiento	30-60794A4, 30-60794A2	1
18-2751	Fuelle union	60932A4	1
18-2760	Tubo escape	78458A1	1
18-3601	Manguito	32-32461	1
18-3602	Manguito	32-41725-33	1
18-2743	Junta	27-94996-2	1
18-2840	Junta	27-35982	1
18-7153	Aro	25-25439	1
18-7117	Aro	25-35027	1
18-710-16-2	Brida	—	2
18-7170	Aro	25-33504	1
18-710-24-2	Brida	—	1
18-2753-1	Fuelle cable cambio	74639	1
18-7321	Brida fuelle	54-38863	1



**18-8205
KIT RETENES TRANSOM**
Reemplaza: 30-803098T1

Para: 1, R, MR, Alpha 1 con tubo escape
*Cojinete engrasable

— CONTIENE —

Ref #	Descripción	O.E. #	Cant.
18-3602	Manguito	32-41725-33	1
18-710-16-2	Brida	—	2
18-710-24-2	Brida	—	1
18-2753-1	Fuelle cable cambio	74639	1
18-7321	Brida fuelle	54-38863	1
18-2100	Rodamiento	30-60794A4, 30-60794A2	1
18-2743	Junta	27-94996-2	1
18-2840	Junta	27-35982	1
18-7153	Aro	25-25439	1
18-7170	Aro	25-33504	1
18-7117	Aro	25-35027	1
18-2750	Fuelle escape	18654A1, 32734A3	1
18-2747	Fuelle dirección	816431A1	1



**18-8206-1
KIT RETENES TRANSOM**
Reemplaza: 30-803099T1

Para: Alpha 1 Gen II
*Cojinete engrasable

— CONTIENE —

Ref #	Descripción	O.E. #	Cant.
18-2753-1	Manguito fuelle	74639	1
18-2100	Cojinete cardán	30-862540A3	1
18-2756	Fuelles	86840A3	1
18-2750	Tubo escape	32734A3	1
18-2760	Tubo escape	78458A1	1
18-3603	Manguera agua	32-43437	1
18-2615	Outdrive Mounting Kit	16755A1	1



**18-8212-1
KIT RETENES TRANSOM**
Reemplaza: 30-803100T1

Para: Todos Bravos 1982 & sup
*Cojinete engrasable



**18-8213
KIT RETENES TRANSOM**
Reemplaza:
Mercruiser 30-803097T1
PARA: R, MR, Alpha 1 (1983-90) S/N
6225577-0D469858; Alpha 1 SS (1986-89)
S/N OA545004 & Sup
*Cojinete 18-21001



**18-8217
KIT RETENES TRANSOM**
Reemplaza:
Mercruiser 30-803098T1
PARA: R, MR, Alpha 1 (1983-90) con tubo
escape S/N 6225577-0D469858; Alpha 1 SS
(1986-89) con tubo escape S/N OA545004 &
sup *Cojinete 18-21001







**18-8218
KIT RETENES TRANSOM**
Reemplaza:
Mercruiser 30-803099T1
PARA: Alpha 1 Gen II (1991 & sup) S/N
0D469859 & sup
*Cojinete 18-21006



**18-8219
KIT RETENES TRANSOM**
Reemplaza:
Mercruiser 30-803100T1
PARA: Bravo I/II/III (1988 & Sup)
S/N 0B664190 & sup; Blackhawk
(1994-95) S/N 0F186717 & sup
*Cojinete 18-21006

 <p>18-2747 CEF 18-2747S FUELLE Alpha I, Gen II Reemplaza: 816431A1</p>	 <p>18-2750 CEF 18-2750S FUELLE Fuelle #1 Units, Gen II, TRS, & Bravo I, II, III Reemplaza: 32734, 32734A3, 18654A1 (Incluye abrazadera 18-7314)</p>	 <p>18-2751 CEF 18-2751S FUELLE TRANSMISIÓN Todos las unidades #1 (S/N 3469428 & SUP) Reemplaza: 60932A1, 60932A4 (Incluye abrazadera 18-710-72-2)</p>
----------------------------------------------------------------------------------------------------------------------------------------------------------------------------------------------	---------------------------------------------------------------------------------------------------------------------------------------------------------------------------------------------------------------------------------------------------------------------------------------	---------------------------------------------------------------------------------------------------------------------------------------------------------------------------------------------------------------------------------------------------------------------------------------

 <p>18-2752 CEF 18-2752S FUELLE TRANSMISIÓN Todas las unidades #1 sin reborde (S/N 3443920 & post) Reemplaza: 36223, 36223A1, 36223A2 (Incluye abrazadera 18-710-72-2)</p>	<p>① 18-2753-2D</p>  <p>18-2753 CEF 18-2753S FUELLE CABLE CAMBIO Todos #1, #2 unidades, Alpha, Bravo I, II, III Reemplaza: 31659, 74639, 74639A2 (Incluye abrazaderas 18-7321)</p>	 <p>18-2756 CEF 18-2756S FUELLE TRANSMISIÓN Reemplaza: 86840A3, 86840A05, 8M0062406 Para todos modelos Bravo y Blackhawk</p>	 <p>18-1710 ARO BRIDA INFERIOR Reemplaza: 862209, 86814 Para: Todos Bravo</p>
------------------------------------------------------------------------------------------------------------------------------------------------------------------------------------------------------------------------------------------------------------------------------------------------------------------	-------------------------------------------------------------------------------------------------------------------------------------------------------------------------------------------------------------------------------------------------------------------------------------------------------------------------	---------------------------------------------------------------------------------------------------------------------------------------------------------------------------------------------------------------------------------------------------------	--------------------------------------------------------------------------------------------------------------------------------------------------------------------------------------------

 <p>18-1728 ARO BRIDA INF Reemplaza: 816607 Para: Alpha One (GenII) (1991 y sup)</p>	 <p>18-2746 CEF 18-2746S TUBO ESCAPE Reemplaza: 32-14358, 32- 14358T, 31-14358001 (4" tubo inferior)</p>	 <p>18-2748 CEF 18-2748S TUBO ESCAPE Reemplaza: 32-44348, 32- 44348T, 31-44348001 (4" Tubo superior)</p>	 <p>18-2759 CEF TUBO ESCAPE Reemplaza: 53114, 53114A1</p>
-------------------------------------------------------------------------------------------------------------------------------------------------------------------------------------------------	------------------------------------------------------------------------------------------------------------------------------------------------------------------------------------------------------------------------------------	--------------------------------------------------------------------------------------------------------------------------------------------------------------------------------------------------------------------------------------	---------------------------------------------------------------------------------------------------------------------------------------------------------------------











 <p>18-2760 CEF 18-2760S TUBO ESCAPE Reemplaza: 78458, 78458A1 (Incluye abrazadera 18-7314) Para: #1, Bravo I, II, III</p>	 <p>18-2761 CEF 18-2761S TUBO ESCAPE 3" D.I. Reemplaza: 32-90949, 32-90949T</p>	 <p>18-2762 CEF TUBO ESCAPE Reemplaza: 70981, 70981A3</p>	 <p>18-2770 CEF TUBO ESCAPE Reemplaza: 32-807458T</p>
--------------------------------------------------------------------------------------------------------------------------------------------------------------------------------------------------------------------------------------------------------	---------------------------------------------------------------------------------------------------------------------------------------------------------------------------------------------------------	---------------------------------------------------------------------------------------------------------------------------------------------------------------------	------------------------------------------------------------------------------------------------------------------------------------------------------------------

① Referencias acabadas en "D" envasadas - Las referencias normales no envasadas

APLICACIONES FUELLES

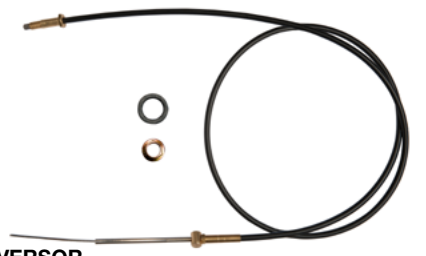
Modelo	Años	Serie #	Fuelles escape	Fuelle Cable cambio	Fuelle Transmisión
I/1A/1B/1C & EZ	1963-1966	1534570-2065186	18-2750	18-2753-2	18-2752
120/140/160/165	1967-1972	2062141-3443920	18-2750	18-2753-2	18-2752
120/140/160/165	1972-1982	3469428-6225576	18-2750	18-2753-2	18-2751
888	1971-1972	3106717-3472477	18-2750	18-2753-2	18-2752
888	1973-1977	3472478 & sup	18-2750	18-2753-2	18-2751
225/233	1974-1977	3856268 & sup	18-2750	18-2753-2	18-2751
898/228/250/260	1977-1982	4782330-6225576	18-2750	18-2753-2	18-2751
R/MR/Alpha One	1983-1990	6225577 & sup	18-2750	18-2753-2	18-2751
R/MR/Alpha One	1983-1990	6225577 & sup	18-2760 ②	18-2753-2	18-2751
Alpha One Gen II	1991 & nuevos	0D469859 & sup	18-2750	18-2753-2	18-2747
Bravo I/II/III	1988 & nuevos	0B664190 & sup	18-2750	18-2753-2	18-2756
Bravo I/II/III	1988 & nuevos	0B664190 & sup	18-2760 ②	18-2753-2	18-2756
Blackhawk	1994-1995	0F18677 & sup	18-2750	18-2753-2	18-2756
Blackhawk	1994-1995	0F18677 & sup	18-2760 ②	18-2753-2	18-2756
II	1962-1969	1474909-2671321	—	18-2753-2	—
215H	1970	2782203-2909034	—	—	18-2752
215E	1970-1972	2909035-2915034	—	18-2753-2	18-2752
TR/TRS	1973-1993	3377316 & sup	—	—	18-2751

② Tubo

<p>Pack. de 5</p>  <p>18-7321 18-7321-9② ABRAZADERA FUELLE Reemplaza: 54-38863, 54-866507, 54-8M0090424</p>	<p>CUERPO CABLE</p> <p>18-2159 Reemplaza: 19543A2, 19543A4, 19543A8, 19543A10, 41951A1, 66065A1, 66069A2, 73679A2, 865436A02 Usar en 18-2157, 18-2158 y sus repuestos de cable y tubo Mercuriser sirga 73"</p>  <p>18-2189 Reemplaza: 32992A1, 34086A1, 37611A1, 38399A2 Usar con 18-2248 Sirga 59"</p>
<p>18-2160 TUBO SOPORTE Reemplaza: 32-38377 Reemplaza tubo en 18-2157, 18-2158 & 18-2159</p> 	<p>18-2248 CONJUNTO CABLE INVERSON Reemplaza: 73723A1, 73723A01, 49518A1, 35187A1, 35187A2, 35187A4 Mercuriser #1 Drives S/N 1562900-6225576 para instalaciones a proa de alojamiento de campana. Nuevo modelo con cable trenzado blindado (sin tubo de soporte) 54" con kit de montaje.</p> 
<p>18-2157 Reemplaza: 19543A2, 41951A1, 19543A8, 19543A10, 19543A4, 66065A1, 66069A2, 73679A2, 865436A02 Mercuriser 1 drives S/N 6225577 & SUP para instalaciones a popa del alojamiento campana. Modelo antiguo con cable trenzado y terminales soldados (Usa tubo guía). 18-2158 Mercuriser #1 Drives S/N 1562900-6225576 para instalaciones a proa del alojamiento de campana. Modelo antiguo con cable trenzado y terminales soldados (Usa tubo guía 18-2160) 63".</p>  <p>CONJUNTO CABLE INVERSON</p>	<p>18-2190 CONJUNTO CABLE INVERSON Reemplaza: 19543A2, 19543A4, 19543A8, 19543A10, 41951A1, 66065A1, 66069A2, 73679A2, 865436A02 Mercuriser 1 drives S/N 6225577 & SUP Para instalaciones a popa del alojamiento campana. Para uso en aplicaciones que utilizan cable con armazón trenzado (Sin tubo soporte). 63" con kit de montaje.</p> 
<p>18-2190E CONJUNTO CABLE INVERSON Reemplaza: 19543A4, 19543A10, 19543A8, 19543A2, 41951A1, 66065A1, 66069A2, 73679A2, 865436A02 S/N 6225577 & SUP. Para instalaciones a popa del alojamiento campana. Para uso en aplicaciones que utilizan cable con armazón trenzado (Sin tubo soporte). 63" con kit de montaje. Conjunto cable inversor inferior- Alpha One (Gen II) (1991-97) Requiere 18-9806E (cable de cambio extreme) para completar la instalación</p> 	<p>18-2145 CONJUNTO CABLE INVERSON Reemplaza: 815471A3, 815471A6, 85147A5, 865437A02, 43432A2, 19297A3</p> 
<p>18-2145E CONJUNTO DE CABLE INVERSON Reemplaza: 815471, A3, A6 Bravo One, Two, & Three (Todos Ratios), Bravo One X/Two X, Three X (Todos Ratios), Bravo One XR/XZ(Todos Ratios), Bravo One XR Sportmaster (Todos Ratios) & Transom Integrados</p> 	<p>18-9806E VASO CABLE CAMBIO Instala y desmonta cables de cambio MC-I, R-MR, Alpha I, Alpha I Gen II drive unidades. Usar con 18-2190 y 18-2190E cables.</p> 
<p>18-2149 TUBO GUÍA CABLE Reemplaza: 22879, 29880, 43433 Para: Alpha & Bravo cables</p> 	<p>Pack de 25</p> <p>18-2303 18-2303-9① TORNILLO RETENEDOR CABLE Reemplaza: 10-20518 Para: #1R, MR, Alpha, Alpha I, Gen II & Bravo</p> 



**18-3754
CABLE ANCLAJE**
Reemplaza: 43436

Para: #1R, MR, Alpha, Alpha I, Gen II & Bravo

**18-2600
KIT INFERIOR CABLE CAMBIO**

— CONTIENE —

Ref #	Descripción	O.E. #	Cant.
18-2619-1	Juego juntas	27-94996A1	1
18-2753-1	Fuelle cable cambio	74639	1
18-2248	Conjunto cable cambio	73723A1	1
18-2162	Pasador y tornillo	33981T	1
18-2149	kit cable cambio	43433	1
18-2163	Tornillo pasador	10-31700	1
18-2743	Junta	27-94996-2	1
18-2820	Junta	27-64818	1
18-2843	Junta	27-94996	1

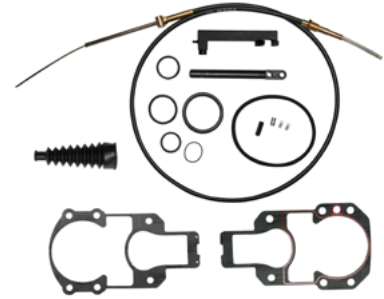

**18-2603
KIT INFERIOR CABLE CAMBIO**
Reemplaza: 19543T1, 19543T2, 865436A03
ALPHA I GENERACIÓN II

— CONTIENE —

Ref #	Descripción	O.E. #	Cant.
18-2619-1	Juego de juntas fueraborda	27-94996A1	1
18-2753-1	Fuelle cable cambio	74639	1
18-2190	Conjunto cable cambio	19543A4	1
18-2743	Junta	27-94996-2	1

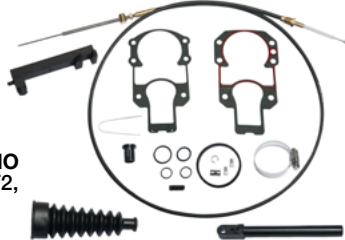

**18-2603E
KIT INFERIOR CABLE CAMBIO (EXTREME)**
Reemplaza: 19543T1, 19543T2, 865436A03

Para: Alpha I Gen II

Usar cable cambio 18-2190E.

Requiere 18-9806E (cable cambio extreme) para completar la instalación

XTREME

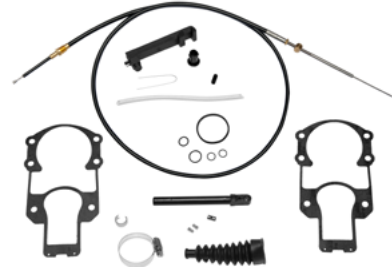

**18-2604
KIT INFERIOR CABLE CAMBIO**
Reemplaza: 815471T1
BRAVO

— CONTIENE —

Ref #	Descripción	O.E. #	Cant.
18-2145	Conjunto cable inv.815471A3	815471A3	1
18-2149	Kit cable cambio	43433	1
18-2753-1	Fuelle cable cambio	74639	1
18-2615	Juego de juntas fueraborda—	27-94996A1	1



**18-2604E
KIT INFERIOR CABLE CAMBIO (EXTREME)**
Reemplaza: 815471T1

Usar cable cambio 18-2145E.

Para: Bravo

XTREME



ABRAZADERAS ACERO INOXIDABLE AISI316

Abrazaderas a tornillo sin fin. Fleje ancho anticortante de 12mm (excepto Ref. 016734, y Ref. 016735 con eje de 9mm). Tornillo inox. Con cabeza hexagonal ranurada de 7mm. Fabricados, totalmente, en Acero inoxidable AISI 316. W5.



Referencia	Ø	Referencia	Ø
016734	8-16mm	016740	50-70mm
016735	12-20mm	016741	60-80mm
016736	20-32mm	016742	70-90mm
016750	25-35mm	016743	90-110mm
016737	24-40mm	016744	110-130mm
016738	35-50mm	016745	140-160mm
016739	40-60mm		

Otras medidas superiores, bajo demanda.

**18-2175
ACOPLADOR DEL MOTOR**

Reemplaza: 12632A2, 12632A4, 18643A7

Usar eje horquilla 18-2146

Platina flexible para últimos modelos.



**18-2195
ACOPLADOR MOTOR**

Reemplaza: 12632A3, 12632A7

Usar con eje horquilla 18-2146

Platina flexible para modelos GM 4 cil.



18-2323
ACOPLADOR MOTOR
Reemplaza: 18643A5
(Igual que 18-2175 sin horquilla)



18-2321
ACOPLADOR MOTOR
Reemplaza: 12632A6
(Igual que 18-2195 sin horquilla)
Para: Último modelo cilindro GM 4



18-21751
ACOPLADOR MOTOR
Reemplaza: 12632A4, 18643A2, 18643A7



18-2412
ACOPLADOR MOTOR
Reemplaza: 18309A2, 18311A2,
18311A17, 812964A2, 861523A9,
8M0098795
Para: Bravo



18-2413
ACOPLADOR MOTOR
Reemplaza: 69354A1, 69354A2
Para: 470, 485 (224 cu. in.)
S/N 4208730-6218036 (1976-1982)



18-2414
ACOPLADOR MOTOR
Reemplaza: 97432A2
Para: 165, 170, 470, 3.7L S/N 6170297 & SUP (1983-1989)
180, 190, 488, 3.7LX S/N 6170297 & SUP (1983-1989)



18-2171
ACOPLADOR MOTOR
Reemplaza: 32492A2, 32492A3, 32492A5,
38965A1, 38965A2, 76850A2
Para todos los motores GM excepto MR/ALPHA/BRAVO
con "Triangular", 3-acoplador tornillo



18-2172
ACOPLADOR MOTOR
Reemplaza: 14505A2
Usados cuando reemplazas retén V6 o V8 2 piezas
traseras con tornillos de 3-1/2" por un retén trasero
de 1 pieza con tornillo.



18-2173
ACOPLAMIENTO MOTOR
Reemplaza: 59826A1, 59826A3
Para motores Ford



APLICACIONES ACOPLADOR MOTOR

HP	Litro	Modelo	CID	# Cil	tiempd	Año	Serie #	Ref #	HP	Litro	Modelo	CID	# Cil	tiempo	Años	Serie #	Ref #
110		110	153	4		1963-1966	1537370 - 2044033	18-2171			190	283	V-8	4	1963-1964	1564539 - 1730903	18-2171
120		120	153	4		1964-1982	1537370 - 6229717	18-2171		5.0L	200	305	V-8	4	1985-1986	6899058 - B525981	18-2171 ①
120		120	153	4	4	1964-1982	1666601 - 6229717	18-2171		5.0L	200	305	V-8	4	1985-1986	6899058 - B525981	18-2175 ②
120		120	153	4	4	1983-1986	6229718 - B531853	18-2171 ③		5.0L	200	305	V-8	4	1985-1987	6899058 - B774444	18-2175
120		120	153	4	4	1983-1986	6229718 - B531853	18-2195 ④		5.0L	228	305	V-8	4	1977-1982	4765100 - 6218461	18-2171
	2.5L	2.5L	153	4	4	1987-1989	B531854 - C853255	18-2171 ⑤		5.0L	228	305	V-8	4	1977-1984	6218462 - 6899268	18-2171
	2.5L	2.5L	153	4	4	1987-1989	B531854 - C853256	18-2195 ⑥		5.0L	230	305	V-8	4	1985-1987	6899269 - B773739	18-2171 ⑦
140		140	181	4	4	1968-1982	2508261 - 6229717	18-2171		5.0L	230	305	V-8	4	1985-1987	6899269 - B773739	18-2175 ⑧
140		140	181	4	4	1983-1986	6229718 - B450800	18-2171 ⑨		5.0L	5.0L ALPHA	305	V-8	4	1988-1993	B774445 - F000000	18-2175
140		140	181	4	4	1983-1986	6229718 - B450800	18-2195 ⑩		5.0L	5.0L ALPHA	305	V-8	4	1994-1995	F000001 - F600999	18-2323
140		140 INLINE 6		6	4	1963	1538930 - 1725960	18-2171		5.0L	5.0L GEN+ ALPHA	305	V-8	4	1998-2010	L015751 & SUP	18-2323
	3.0L	3.0L	181	4	4	1987-1989	B450801 - C856558	18-2171 ⑪		5.0L	5.0L GEN+ BRAVO	305	V-8	4	1998-2010	L015751 & SUP	18-2412 ⑫
	3.0L	3.0L	181	4	4	1987-1989	B450801 - C856558	18-2195 ⑬		5.0L	5.0L EFI ALPHA	305	V-8	4	1998-2001	L012052 - M299999	18-2323
	3.0L	3.0L	181	4	4	1990-1994	C856559 - F603999	18-2195		5.0L	5.0L EFI BRAVO	305	V-8	4	1998-2001	L015751 - M299999	18-2412 ⑭
	3.0L	3.0L	181	4	4	1998-2010	L097000 & SUP	18-2323		5.0L	5.0LX ALPHA	305	V-8	4	1988-1993	B773740-F000000	18-2175
	3.0L	3.0L MPI	181	4	4	2008-2010	A072812 & SUP	18-2323		5.0L	5.0LX ALPHA	305	V-8	4	1994-2007	F000001 & SUP	18-2323
	3.0L	3.0LX	181	4	4	1990-1993	C856559 - F000000	18-2195		5.0L	5.0L MPI BRAVO	305	V-8	4	1998-2007	L015751 & SUP	18-2412
	3.0L	3.0LX	181	4	4	1994-1998	F000001 - L096999	18-2321		5.0L	5.0L MPI ALPHA	305	V-8	4	2002-2010	M300000 & SUP	18-2323
150		150		4	4	1964-1966	1666495 - 2048046	18-2171		5.0L	5.0L MPI BRAVO	305	V-8	4	2002-2010	M300000 & SUP	18-2412 ⑮
160		160		4	4	1967-1969	2048022 - 2770031	18-2171		5.0L	5.0LX ALPHA	305	V-8	4	1988-1993	B773740 - F000000	18-2175 ⑯
165		165	224	4	4	1987	B434941 - B774251	18-2414		5.0L	5.0LX ALPHA	305	V-8	4	1994-1995	F000001 - F600999	18-2323
165		165 INLINE 6		6	4	1970-1981	2770032 - 5813433	18-2171		5.0L	898	305	V-8	4	1977-1985	4762210 - 6899057	18-2171
170		170	224	4	4	1985-1986	6916779 - B434940	18-2414		225 (GM)	327	V-8	4	1963-1969	1539620 - 2694014	18-2171	
180		180	224	4	4	1987	B436391 - B775248	18-2414		250	327	V-8	4	1977	4768000 - 4908849	18-2171	
190		190	224	4	4	1985-1987	6916779 - B775248	18-2414		5.7L	280	350	V-8	4	1978-1982	4908850 - 6218461	18-2171
	3.7L	3.7L	224	4	4	1988-1989	B774252 & SUP	18-2414		5.7L	280	350	V-8	4	1982-1986	6218462 - B525981	18-2171 ⑰
	3.7L	3.7LX	224	4	4	1983-1989	B775249 & SUP	18-2414		5.7L	280	350	V-8	4	1982-1987	6218462 - B773304	18-2175 ⑱
		470	224	4	4	1976-1982	4206730 - 6218036	18-2413		5.7L	280	350	V-8	4	1987	B525982 - B773304	18-2175
		470	224	4	4	1983-1984	6218037 - 6916779	18-2414		5.7L	300 TEMPEST ALPHA	350	V-8	4	1985-1986	6666677 - B430367	18-2171 ⑲
		485	224	4	4	1980-1982	5685394 - 6218036	18-2413		5.7L	300 TEMPEST ALPHA	350	V-8	4	1986	A434310 - B430367	18-2175 ⑳
		488	224	4	4	1983-1984	6170297 - 6916779	18-2414		5.7L	320 EFI	350	V-8	4	1987-1989	A543604 - C622418	18-2175
		140	194	6	4	1963	1538930 - 1664117	18-2171		5.7L	350 MAG ALPHA	350	V-8	4	1986-1993	A635178 - F000000	18-2175
		150	230	6	4	1964-1966	1664118 - 2048046	18-2171		5.7L	350 MAG ALPHA	350	V-8	4	1993-1997	F000001 - K999999	18-2323
		160	250	6	4	1967-1969	2048022 - 2770031	18-2171		5.7L	350 MAG ALPHA EFI GEN +	350	V-8	4	1996-1997	F800300 - K999999	18-2323
		165	250	6	4	1970-1981	2770032 - 5813433	18-2171		5.7L	350 Mag MPI ALPHA	350	V-8	4	1998-2010	L010019 & SUP	18-2323
175		175		4	4	1987	B527955 - B773242	18-2175		5.7L	350 MAG MPI BRAVO	350	V-8	4	1998-2010	L010019 & SUP	18-2412 ㉑
175		185 (4bb1)	229	6	4	1983-1984	6330183 - 6919655	18-2171		5.7L	350 MAG MPI HORIZON ALPHA	350	V-8	4	2002-2007	M300000 - A299999	18-2323
175		175	262	V-6	4	1987	B527955 - B773242	18-2175		5.7L	350 MAG MPI HORIZON BRAVO	350	V-8	4	2002-2007	M300000 - A299999	18-2412 ㉒
185		185 (2bb1)	262	6	4	1985-1986	A331455 - B527954	18-2171 ㉓		5.7L	350 MAG MPI HORIZON ALPHA	350	V-8	4	1993-2007	F000001 & SUP	18-2323
185		185 (2bb1)	262	6	4	1985-1986	A331455 - B527954	18-2175 ㉔		5.7L	HORIZON BRAVO	350	V-8	4	1999-2007	M300000 & SUP	18-2412
205		205	262	6	4	1985-1986	A331455 - B527954	21-2171 ㉕		5.7L	5.7L ALPHA	350	V-8	4	1988-1993	B773305-F000000	18-2175
205		205	262	6	4	1985-1986	A331455 - B527954	18-2175 ㉖		5.7L	5.7L ALPHA	350	V-8	4	1993-2010	F000001 & SUP	18-2323
205		205	262	6	4	1987	B527955 - B775129	18-2175		5.7L	5.7L BRAVO	350	V-8	4	1988-2010	B773305 & SUP	18-2412 ㉗
		262 MAG EFI GEN+	262	V-6	4	1996-1997	F803800 - K999999	18-2323		5.7L	5.7L EFI ALPHA	350	V-8	4	1995-2001	F225560 - K999999	18-2323
	4.3L	4.3L	262	V-6	4	1988-1993	B527955 - F000877	18-2175		5.7L	5.7L EFI BRAVO	350	V-8	4	1998-2001	L010035 - M299999	18-2412 ㉘
	4.3L	4.3L	262	V-6	4	1993-2010	F000878 & SUP	18-2323		5.7L	5.7LX EFI ALPHA	350	V-8	4	1996-1997	F752400 - K999999	18-2323
	4.3L	4.3L EFI GEN +	262	V-6	4	1998-2001	L012009 - M299999	18-2323		5.7L	5.7LX EFI ALPHA	350	V-8	4	1993-2007	F000001 & SUP	18-2323
	4.3L	4.3L MPI	262	V-6	4	2002-2010	M300000 & SUP	18-2323		5.7L	5.7L EFI BRAVO	350	V-8	4	1998-2007	L010035 & SUP	18-2412 ㉙
	4.3L	4.3LH GEN +	262	V-6	4	1998-2002	L010044 - M614999	18-2323		5.7L	233	351	V-8	4	1975-1977	4173000 - 4902304	18-2173
	4.3L	4.3LX	262	V-6	4	1988-1993	B775130 - F001219	18-2175		6.2L	377 MAG	377	V-8	4	2008-2010	A300000 & SUP	18-2412 ㉚
	4.3L	4.3LX (4bb1)	262	V-6	4	1993-1995	F001220 - F802999	18-2323		6.2L	MX 6.2L MPI	377	V-8	4	2000-2007	L680003 - A299999	18-2412 ㉛
	4.3L	4.3LX GEN + (2bb1)	262	V-6	4	1996-1997	F803000 - K999999	18-2323		6.2L	MX 6.2L MPI	377	V-8	4	2000-2007	L680003 - A299999	N/D ㉜
	4.3L	4.3LXH GEN +	262	V-6	4	1996-1997	F803000 - K999999	18-2323		6.2L	MX 6.2L MPI HORIZON	377	V-8	4	2002-2007	M300000 - A299999	18-2412 ㉝
	5.0L	225 (FORD)	302	V-8	4	1973-1974	3385721 - 4166999	18-2173 ㉞		7.4L	454 MAG ALPHA	454	V-8	4	1986-1988	A631894 - B785148	18-2175 ㉟
	5.0L	888	302	V-8	4	1971-1977	3108723 - 4887829	18-2173									

- ① Usar con transmisión Borg Warner
- ② Baja velocidad / aplicación de trabajo
- ③ Montaje doble al volante
- ④ Usar con transmisión Hurth

- ⑤ Sólo cambio hidráulico
- ⑥ Sólo I
- ⑦ Acople redondo
- ⑧ Aplicaciones standard Bravo

- ⑨ Montaje acoplador a cigüeñal
- ⑩ Adaptador Triangular
- ⑪ Usar con transmisión Borg Warner 71/72 en línea
- ⑫ Usar con transmisión Borg Warner 5000 o Hurth 630



18-4442
HERRAMIENTA ALINEACIÓN
Reemplaza: 91-57797A3, 91-57797A2, 91-57797A1,
91-8M0067546, 91-805475A1, 91-48347, 91-37384
Para usar con todos #1 unidades, MR, todas unidades
Alpha & Bravo



18-9803
LLAVE PARA COJINETES
Reemplaza: 91-36235

Grasa Marina

18-9240-0
(8 oz Tube)
Reemplaza:
Mercury 92-802859A1

18-9240-1
(14oz Cartucho)
Reemplaza:
Mercury 92-802863A1

- Evita la corrosión y óxido
- Evita el desgaste contra la más extrema fricción en aplicaciones marinas.
- No se romperá en condiciones marítimas.
- Contiene PTFE para un mínimo desgaste y fricción añadido protección.
- Para usar en ejes de apoyo, cojinetes de remolque, cables de acelerador y cambio y varillaje, pasadores giratorios y más.



18-2200
KIT ENGRANAJES
Reemplaza: 43-61027, 43-96084A4
888 S/N 3106717 & SUP #1 Unidades S/N 3469428 & SUP Excepto,
MR/ALPHA Unidades (Sin pie en el eje de dirección).



18-2410
JUEGO ENGRANAJES MARCHA ADELANTE
Reemplaza: 43-96084A7, 43-96084A5
Para: transmisiones "R"

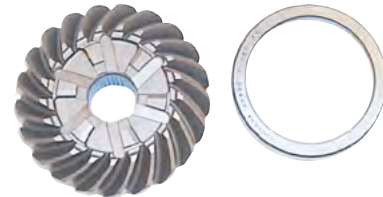

18-2360
PIÑÓN Y JUEGO ENGRANAJES MARCHA ADELANTE
Reemplaza: 43-828072A3, 43-878087A2
dientes 13-21



18-2206-1
KIT ENGRANAJES PARTE INFERIOR
Reemplaza: 43-878087A2 + 43-828073A1,
43-828072A2
Para: Todos MR/ALPHA/Gen II
(Excepto Gen II 2.00-2.40 ratios)



18-2409
ENGRANAJES MARCHA ATRAS
Reemplaza: 43-92320, 43-92320T
Para: transmisiones "R" (dientes 28)



18-2406
JUEGO DE ENGRANAJES MARCHA ADELANTE
Reemplaza: 43-878087A2, 43-878072A3
Para: MR/Alpha/Gen II inf S/N D469859 & SUP

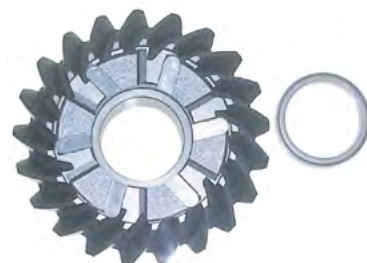

18-2408
ENGRANAJES MARCHA ATRAS
Reemplaza: 43-828073A1
Para: Alpha I/Gen II inferior S/N D469859 & SUP

18-2404
KIT REPARACIÓN ENGRANAJES
Reemplaza: 43-803079T1
Para: Transmisión "R"

— CONTIENE —

Ref #	Descripción	O.E. #	Cant.
18-2200	Kit parte inferior	43-96084A4	1
18-2202	Desplazable embrague	52-66063	1
18-1157	Cojinete	31-30895	1
18-1155	Cojinete	30-88957A1	1
18-1159	Cojinete	31-35928A1	1
18-2285	Gruesa	15-47397A1	1
18-3719	Tuerca	11-35921	1
18-2299	Arandela	14-79447	1



18-2405
KIT REPARACIÓN ENGRANAJES
Reemplaza: 43-803091T1
Para: MR/Alpha I

— CONTIENE —

Ref #	Descripción	O.E. #	Cant.
18-2652	Kit retenes	26-33144A2	1
18-3719	Tuerca	11-35921	1
18-2343	Arandela	12-982721	1
18-2298	Arandela	14-18323	1
18-2299	Arandela	14-79447	1
18-2206-1	Juego engranajes	43-42934	1
18-2285	Grueso	15-47397A1	1
18-1155	Cojinete	30-88957A1	1
18-1158	Cojinete	31-30956	1
18-1117	Cojinete	31-42647A1	1
18-1143	Cojinete Alpha	31-36387A1	1
18-2294	Kit gruesos	15-42637A-1	1
18-2202	Desplazable embrague	52-66063	1



18-2368
KIT CARCASA INFERIOR
Reemplaza: 43-803071T1
ALPHA/GEN II 1996-97



18-2369
KIT CARCASA INFERIOR
Reemplaza: 43-803069T1
ALPHA/GENII 1991-95

18-2407
KIT ENGRANAJES

Reemplaza:
43-878087A4, 43-823072A2, 43-42933A3,
43-42933A2, 43-17064A3

Para: MR/Alpha/Gen II
Alojamiento engranaje inf

— CONTIENE —

Ref #	Descripción	O.E. #	Cant.
18-2206-1	Juego engranajes	43-42934	1
18-1155	Cojinete	30-88957A1	1
18-1117	Cojinete	31-42647A1	1
18-1158	Cojinete	31-30956	1
18-1143	Cojinete Alpha	31-36387A1	1
18-2294	Grueso Kit	15-42637A-1	1
18-2285	Grueso	15-47397	1
18-3719	Tuerca	11-35921	1
18-2343	Arandela	12-982721	1



18-2202
EMBRAGUE
DESLIZANTE
Reemplaza:
52-66063,
52-853594T,
52-853594, 52-824112
888 S/N 3784375 & SUP
#1 Unid. S/N 3469428 & SUP



18-2357
PASADOR
Reemplaza:
17-30632,
17-8M0030941,
17-8M0084681

Pack. de 2



18-2348
18-2348-9①
MUELLE TRINQUETE
Reemplaza: 24-30893
1/MC-1/R/MR/Alpha
Mercruiser/Gen II inferior
S/N D469859-F679999
Mercruiser Vazer



18-2166
EJE TRANSMISIÓN
Reemplaza: 44-66060, 44-660603, 44-824110, 44-660602,
44-55857
Para todos #1 & MR/ALPHA Unidades S/N 2791957 & ant.
Also for 165 (6 cil.) S/N 2763442 & ant.

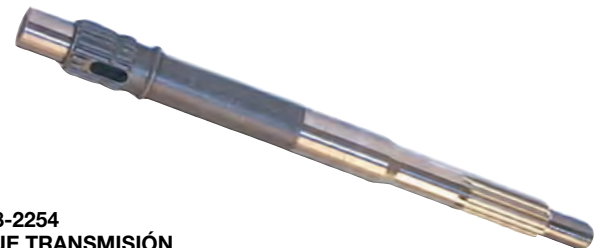

18-2254
EJE TRANSMISIÓN
Reemplaza: 44-850308
Para: Alpha One Gen II S/N 0L100040 & sup/Vazer



18-2180
EJE TRANSMISIÓN
Reemplaza: 45-42634
Para todos MR/ALPHA Unidades que hayan sido re-equipadas con unidades inferiores MR/ALPHA.



18-2331
EJE TRANSMISIÓN
Reemplaza: 45-853648, 45-853647
Para: Ratios 1.47, 1.62, 1.81 & 1.94.
Para: Gen II (1998 & sup), (0L100040 & sup)
Para usar con: 18-2400 parte inferior



18-2261
EJE TRANSMISIÓN
Reemplaza: 45-816919
Todos Alpha I Generación II (con impulsor de modelo nuevo 18-3056)
Serie #D494569 & superiores.



18-2346
COJINETE
Reemplaza: 824519, 8245191, 11-42633, F694961, F694961-1
Para: MR Alpha & Gen II



18-3719
TUERCA PIÑÓN
Reemplaza: 11-35921, 11-47411,
11-826375, 11-F694188
5/8" - 18 dientes • Llave 1 1/16"

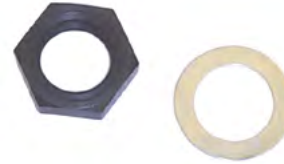

18-2359
JUEGO TUERCAS EJE TRANSMISIÓN
— INCLUYE —

Sierra #	Descripción	Reemplaza:
18-3719	Tuerca	11-35921
18-2343	Arandela de tuerca piñón	12-92721



18-2286
Reemplaza: 66067, 66067T,
19755A2, 808349A1, 808349T1

18-2196
Reemplaza: 37967, 61073,
19755A4, 19755A08

CARRETE

APLICACIÓN CARRETE

Modelo	Serie #	Ref #
1A (EZ-Shift)	1776349 & SUP	18-2196
1B (EZ-Shift)	1775193 & SUP	18-2196
1C (EZ-Shift)	1777799 & SUP	18-2196
120/140	2062141-3780849	18-2196
120/140	3780850 & SUP	18-2286
160	2065190-2763441	18-2196
165	2763442-3780849	18-2196
165	3780850 & SUP	18-2286
888	3106717-3784374	18-2196
888	3784375 & SUP	18-2286
898/228	4782330 & SUP	18-2286
225-S	3856268-4200499	18-2286
233	4200500 & SUP	18-2286
470/485	4208730 & SUP	18-2286
R/MR/Alpha One	6225377 & SUP	18-2286
Alpha One (Gen II)	D494569 & SUP	18-2286



18-3759
ARANDELA EMPUJE
Reemplaza: 35915



18-2342
ARANDELA
Reemplaza: 68100, 681001
Para: MR/ ALPHA



18-2191
COJINETE DIABOLO
Reemplaza: 56211A1, 73020A1,
73020A14
Para: #1R/MR/Alpha I
Para: Alojamiento con n° de serie #73020C



18-2376
COJINETE DIABOLO
Reemplaza: 73020A20, 818763A4, 818763A10
Para: Alpha Gen II & MR Unidades
Para: alojamiento con n° de serie #73020C1, Mercuriser Vazer



18-2150
EJE CAMBIO
Reemplaza: 37973, 65028, 66066, 77481, 774811
Acero inoxidable



18-2353
ALOJAMIENTO COJINETE
Reemplaza: 23-815921A21, 23-815921A17, 23-815921A10, 23-815921A8, 23-815921A6, 815921A2



18-2154
CASQUILLO
Reemplaza: 23-30617A1, 23-30617A2
Mercuriser & Alpha 1 (S/N 1684188 & SUP)



18-3198
REJILLA TOMA DE AGUA
Babor
Reemplaza: 93424, 934241, 934243
Para: MR Alpha



18-3199
REJILLA TOMA DE AGUA
Estribor
Reemplaza: 93423, 934231, 934233
Para: MR Alpha



18-2320
EJE CAMBIO
Reemplaza: 815919A1
Para: Gen II



18-2130
LEVA CAMBIO
Reemplaza: 66062, 76865, 8M2009865
Para todos #1 Units R/MR/Alpha, Mercuriser Vazer

Pack. de 2



18-4295
18-4295-9①
CLIP
Reemplaza: 53-29641
Para: Gen II



18-2299
ARANDELA CIERRE
Reemplaza: 14-79447, 14-52833



18-2298
ARANDELA CIERRE
Reemplaza: 14-18323, 14-17460



18-3751
TUERCA
Reemplaza: 79448
Para: Mercuriser Vazer



18-2354
CIERRE RETÉN
Reemplaza: 821759A4, 821759A3, 821759A2, 821759A1, 815922A5, 815922A1, 807929A2, 807929A1



18-1120
COJINETE PIÑÓN
Reemplaza: 31-35246 Para unidad inferior III, TR, Bravo I, II, III (1986-95)



18-1117
COJINETE PIÑÓN
Reemplaza: 31-42647A1



18-1356
COJINETE PIÑÓN
Reemplaza: 31-54928

Modelo	Año	Modelo	Año
215 E/H	1970-72	II, TR	1973-76
225TRS, 280 TRS	1973-76	TR, TRS	1977-93



18-1142
COJINETE PIÑÓN SUPERIOR
Reemplaza: 31-32573A1

① Precio por pack



18-1193
COJINETE RODILLOS
Reemplaza: 31-33138A1
Para: Gen II (1998-Sup), Mercruiser Vazer



18-1143
COJINETE RODILLOS
Reemplaza: 31-36387A1



18-1156
COJINETE RODILLOS AVANCE
Reemplaza: 31-30894A1
Para: Mercruiser Vazer



18-1161
COJINETE RODILLOS
Reemplaza: 31-35990A1
Para: Mercruiser Vazer



18-1162
COJINETE RODILLOS
Reemplaza: 31-38356A1, 31-F84901, FA84901, F84903



18-1164
COJINETE RODILLOS
Reemplaza: 31-53079A1, 31-53079



18-1165
COJINETE RODILLOS
Reemplaza: 31-61100A1



18-1163
COJINETE RODILLOS
Reemplaza: 31-48941A1



18-1173
COJINETE RODILLOS
Reemplaza: 31-828437A2



18-1126
COJINETE RODILLOS
Reemplaza: 31-8M0103474



18-1179
COJINETE RODILLOS
Reemplaza: 31-32575A1, T1
Para: Gen II F680000 & SUP, Mercruiser Vazer



18-1127
COJINETE RODILLOS
Reemplaza: 31-54038A1
Para: Bravo II - inferior (S/N B664190 & SUP)



18-1182
KIT COJINETE RODILLO
Reemplaza: 31-30894A5
Para: Alpha I (Gen II) (1998 & sup) (OL100040 & sup), Mercruiser Vazer



18-1197
COJINETE
Reemplaza: 31-828439A2
Para: Alpha I (Gen II) (1996-97) (OF680000-OK999999)



18-1129
COJINETE EJE TRANSMISIÓN SUPERIOR
Reemplaza: 31-86748A1, 31-8M0103473, 31-F506818, F508814
Para: Bravo I, II, III - inferior (S/N B664190 & SUP)



18-1150
COJINETE RODILLO
Reemplaza: 31-92366A1, 31-92366



18-1157
COJINETE AGUJA
Reemplaza: 31-30895, 31-30895T
Para: Mercruiser Vazer



18-1158
COJINETE AGUJA
Reemplaza: 31-30956, 31-30956T, 31-F523058
Para: Mercruiser Vazer



18-1153
COJINETE A BOLAS
Reemplaza: 30-63326, 30-63326T, 30-49313, 30-54215, 30-20464



18-1155
COJINETE A BOLAS
Reemplaza: 30-88957A1, 30-88957T, 30-35914, 30-17927, 30-89957



18-1160
KIT COJINETES
Reemplaza: 31-35988A2, 31-35988A12

COJINETES PARA ENGRANAJES SUPERIORES DE COLAS MERCURISER

Modelo colas	Relación	Año	Nº de serie	Cojinete Transom	Cojinete Bolas	Tapa superior
IA,IB,IC & EZ Shift	Todos	1964-66	1684188 - 2065186	18-1160	18-1161	18-1179
120/140	1.98	1967	2062141- 2187468	18-1160	18-1161	18-1161
120/140	1.98	1967-71	2187469 - 3134193	18-1160	18-1161	18-1179
120/140	1.98	1971-82	3134194 - 6225576	18-1160	18-1161	18-1165
470/485	1.84	1976-82	4208730 - 6225576	18-1160	18-1161	18-1165
160	1.68	1967	2065190 - 2182197	18-1160	18-1161	18-1161
160	1.68	1967-71	2182198 - 3134193	18-1160	18-1161	18-1179
165	1.65	1971-81	3213658 - SUP	18-1160	18-1161	18-1165
888	1.5	1971-73	3106717 - 3134193	18-1160	18-1161	—
888	1.5	1973-77	3134194 - SUP	18-1160	18-1161	18-1165
225-S	1.5	1974	3856268 - 4200499	18-1160	18-1161	18-1165
898/228	1.65	1977-82	4782330 - 6225576	18-1160	18-1161	18-1165
233	1.32	1975-77	4200500 - SUP	—	—	18-1165
250	1.32	1977	4791300 - 4898729	—	—	18-1165
255-TRS	Todos	1973-74	3377316 - 4203749	18-1162 ③	18-1162	—
260	1.5	1978-82	4898730 - 6225576	18-1160	18-1161	18-1165
280-TRS	Todos	1975-76	4203750 - 4895399	18-1162 ③	18-1162	—
R/MR/Alpha One	1.98/1.84/ 1.65/1.50	1984-90	6225577 - SUP	18-1160	18-1161 ① ④	18-1165
R/MR/Alpha One	1.5	1984-90	6225577 - SUP	18-1160	18-1142	18-1165
R/MR/Alpha One	1.32	1984-90	6225577 - SUP	—	—	18-1165
R/MR/Alpha One	1.5 Heavy Duty	1984-90	6225577 - SUP	—	18-1142	18-1165
Alpha One SS	1.32	1986-89	A545004 - SUP	—	—	18-1165
Alpha One SS	1.5	1986-89	A545004 - SUP	—	18-1142	18-1165
Alpha One Gen II	2.40/1.98/ 1.84/1.65	1991-95	D469859 - F679999	18-1160	18-1161 ④	18-1165
Alpha One Gen II	1.5	1991-95	D469859 - F679999	18-1160	18-1142	18-1165
Alpha One Gen II	2.40/1.94/ 1.81/1.62	1996-97	F680000 - K999999	18-1160	18-1161 ④	18-1179
Alpha One Gen II	1.47	1996-97	F680000 - K999999	18-1160	18-1142	18-1179
Alpha One Gen II	2.40/2.00/ 1.94/1.81/ 1.62	1998 & sup	L100040 - SUP	—	18-1161	18-1179
Alpha One Gen II	1.47	1998 & sup	L100040 - SUP	—	18-1142	18-1179
II-TR	—	1973-76	3377316 - 4794899	18-1162 ②	18-1162	—
SSM II	—	1982-97	TODOS	18-1162 ③	18-1162	—
TR/TRS	—	1977-93	4794900 - SUP	18-1162 ③	18-1162	—
Bravo I, II, III	TODOS	—	B664190 & SUP	—	—	18-1129

① Con # 89449 / Cup 89410
② Sólo engranajes rectos

③ Cojinete para horquilla cardan
④ Usar 18-1142 para 1.5:1 relación

COJINETES PARA ENGRANAJES INFERIORES DE COLAS MERCURISER



















Modelo cola	Año	Desde. S/N - hasta. S/N	Rodamiento Eje hélice	Rodamiento eje vertical (Piñón)	Eje transmisión superior	Rodamiento interior piñón adelante	Rod. exterior piñón adelante	Rod. piñón marcha atrás
60	1965-66	1830753 - 2063740	—	—	—	—	18-1162	—
80/90	1966-72	2063741 - 3225967	18-1158	—	—	18-1157	18-1156	—
I	1963	1534570 - 1536617	18-1158	—	18-1153	18-1157	18-1156	—
I	1963	1536618 - 1684187	18-1158	—	—	18-1157	18-1156	—
IA,IB,IC & EZ Shift	1964-66	1684188 - 2065189	18-1158	—	—	18-1157	18-1159	18-1155
120/140	1967-69	2062141 - 2791956	18-1158	—	18-1164 ④	18-1157	18-1159	18-1155
120/140	1970-77	2791957 - 4893634	18-1158	—	18-1164	18-1157	18-1159	18-1155
120/140	1978-82	4893635 - 6225576	18-1158	18-1150	18-1164	18-1157	18-1159	18-1155
470	1976-77	4208730 - 4893934	18-1158	—	18-1164	18-1157	18-1159	18-1155
470/485	1978-82	4893835 - 6225576	18-1158	18-1150	18-1164	18-1157	18-1159	18-1155
160	1967-69	2065190 - 2763441	18-1158	—	18-1164 ④	18-1157	18-1159	18-1155
165	1970-77	2763442 - 4890459	18-1158	—	18-1164	18-1157	18-1159	18-1155
165	1978-81	4890460 - SUP	18-1158	18-1150	18-1164	18-1157	18-1159	18-1155
888	1971-77	3106717 - SUP	18-1158	—	18-1164	18-1157	18-1159	18-1155
225/233 18-1155	1974-77	3856268 - SUP	18-1158	—	18-1164	18-1157	18-1159	—
898/228	1977	4782330 - 4898729	18-1158	—	18-1164	18-1157	18-1159	18-1155
898/228	1978-82	4898730 - 6225576	18-1158	18-1150	18-1164	18-1157	18-1159	18-1155
250	1977	4791300 - 4898729	18-1158	—	18-1164	18-1157	18-1159	18-1155
255-TRS	1973-74	3377316 - 4203749	18-1158	—	—	—	18-1159	N/D
260	1978-82	4898730 - 6225576	18-1158	18-1150	18-1164	18-1157	18-1159	18-1155
280-TRS	1975-76	4203750 - 4895399	18-1158	—	—	—	18-1159	N/D
R	1983	6225577 - SUP	18-1158	18-1150	18-1164	18-1157	18-1159	18-1155
MR / Alpha One	1984-90	6225577 - SUP	18-1158	18-1117	18-1143	—	18-1159 ⑤	18-1155
MR / Alpha One	1984-90	6225577 - SUP	18-1158	18-1117	18-1143	18-1157 ②	18-1159 ⑤	18-1155
MR / Alpha One (CR)	1984-90	6225577 - SUP	18-1158	18-1117	18-1143	—	—	—
Alpha One SS	1986-89	A545004 - SUP	18-1158	18-1117	18-1143	18-1157	18-1159	18-1155
Alpha One Gen II	1991-95	D469859 - F679999	18-1158	18-1117	18-1143	18-1157	18-1159 ⑤	18-1155
Alpha One Gen II (CR)	1991-95	D469859 - F679999	18-1158	18-1117	18-1143	—	—	—
Alpha One Gen II	1996-97	F680000 - K999999	18-1158	18-1117	18-1143	18-1157	18-1156	18-1155
Alpha One Gen II (CR)	1996-97	F680000 - K999999	18-1158	18-1117	18-1143	—	—	—
Alpha One Gen II	1998-newer	L100040 - SUP	18-1158	18-1117	18-1143	18-1157	18-1156 ③	18-1155
Alpha One Gen II (CR)	1998-newer	L100040 - SUP	18-1158	18-1117	18-1143	—	—	—
II	1962-67	1474909 - 2275488	—	—	—	N/D	18-1156 ③	N/D
II ③	1968-69	2398798 - 2671321	—	—	—	—	18-1162	18-1156
II-TR	1973-76	3377316 - 4794899	—	—	18-1161 ①	—	—	N/D
TR	1973-93	4794900 - SUP	—	—	18-1161 ①	—	—	N/D
TRS	1973-93	4794900 - SUP	18-1158	—	—	—	18-1159	N/D

① 18-1161 Rodamiento superior / 18-1163 Rodamiento eje vertical

② Torrington#B1616
③ Piñón eje hélice

④ #15520 gravado en la tapa

⑤ Usar 18-1173 para 2.40:1 sólo ratio (nuevo modelo piñones parte inferior) 18-2206-1

 <p>18-2349 CASQUILLO GOMA Reemplaza: 23-67370</p>	 <p>18-2244 18-22441-9^① (Pack. de 50 sin junta) TAPÓN DRENAJE Reemplaza: 10-79953A2, 10-79953, 10-79953Q04, 10-28634, 10-28634A1, 10-20259, 816610A1, 816610A2, F40109, 10-F50109 Para: #1/R/MR/Alpha/Alpha I Gen II Para ambas unidades inferior y superior</p>	 <p>② 18-2375D  18-2375 18-23751-9^① (Pack de 50 sin junta) TAPÓN DRENAJE Reemplaza: 10-14834, 10-14834A1, 22-67892, 22-67892A1, 22-67892A05, 22-67892A06, 22-8M0058389 (Magnético) Para: Alpha MR/Gen II unidades inferiores No para usar en unidades inferiores #1/R</p>	 <p>18-2460 KIT TAPONES Reemplaza: 22-88847A1, 11-88462 Para: Mercruiser</p>								
 <p>18-72005 KIT TUERCAS Y ARANDELAS Para: Transmisiones Mercruiser R/MR/Alpha/Gen II</p>	 <p>① 18-4220D  18-4220 ARANDELA EMPUJE Reemplaza: 13171, 77987 V-6, fuerabordas & colas Mercruiser</p>	 <p>18-3784 ARANDELA EMPUJE Reemplaza: 805100 Para: Bravo III (Frontal)</p>									
 <p>② 18-3701D  18-3701 KIT TUERCAS HÉLICE Reemplaza: 11-52707A1, 11-52707A2, 11-52707Q1 — CONTIENE —</p> <table border="1" data-bbox="170 1181 609 1266"> <thead> <tr> <th>Ref #</th> <th>O.E. #</th> <th>Descripción</th> </tr> </thead> <tbody> <tr> <td>18-3200</td> <td>14-31210, 14-816629, 14-816629Q, 14-F697140</td> <td>Arandela</td> </tr> <tr> <td>18-3700</td> <td>11-52707</td> <td>Tuerca</td> </tr> </tbody> </table>	Ref #	O.E. #	Descripción	18-3200	14-31210, 14-816629, 14-816629Q, 14-F697140	Arandela	18-3700	11-52707	Tuerca	 <p>18-3755 KIT TUERCAS HÉLICE Para: Bravo III (Frontal)</p>	 <p>18-3756 KIT TUERCAS HÉLICE Para: Bravo III (posterior)</p>
Ref #	O.E. #	Descripción									
18-3200	14-31210, 14-816629, 14-816629Q, 14-F697140	Arandela									
18-3700	11-52707	Tuerca									
<p>Pack de 10</p>  <p>18-3200 18-3200-9^① ARANDELA Reemplaza: 14-31210, 14-816629, 14-816629Q, 14-F697140</p>	 <p>18-3787 ARANDELA Reemplaza: 805101T Para: Bravo III (posterior)</p>	<p>Pack de 10</p>  <p>18-3788-9^① ARANDELA Reemplaza: 14-34817 Para: Bravo II</p>									
 <p>18-72510 KIT TORNILLO Para: Mercruiser acoplador al volante</p>	 <p>18-3783 TUERCA HÉLICE Reemplaza: 11-859131, 11-805092, 11-805092T, 11-805100T Para: Bravo III (Frontal)</p>	 <p>18-3785 TUERCA HÉLICE Reemplaza: 11-82671127, 11-54034, 11-39907, 11-39823 Para: Bravo II</p>	 <p>18-3786 TUERCA HÉLICE Reemplaza: 11-862907, 11-805093 Para: Bravo III (posterior)</p>								

① Precio por pack

② Referencias acabadas en "D" envasadas - Referencia normal no envasada



18-3700
TUERCA HÉLICE
Reemplaza: 11-52707,
11-52707A1, 11-52707Q1,
11-52707A2, 11-827614,
F7040
3/4" - 20 dientes • Llave 1 1/16"



18-3714
ARANDELA DE BRONCE
Reemplaza: 12-31211A2,
12-31211, 12-31211A3,
12-31211Q03
Para: Alpha/Bravo I (Sin Flo-Torq II Hub)
NOTA: Para los productos anteriores con
núcleos de goma (no-Flo-Torq II)



18-4444
HERRAMIENTA TUERCA HÉLICE
Reemplaza: 91-95830A1, 91-95830, 91-38277A1



18-4459
HERRAMIENTA TUERCA HÉLICE
Reemplaza: 91-821887A1, 91-859046Q4, 91-859046T4



18-4446
KIT HERRAMIENTA TUERCA HÉLICE
—CONTIENE—

Ref #	O.E. #	Descripción
18-3200	14-31210, 14-816629	Arandela
18-3700	11-52707	Tuerca hélice
18-4444	91-95830A1	herramienta tuerca hélice

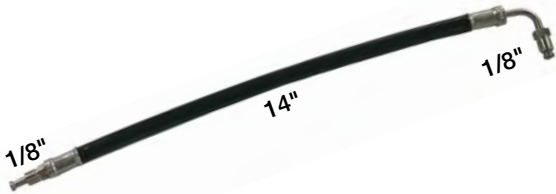

18-2103
LATIGUILLO TRIM
Reemplaza: 32-47373, 32-66073, 32-68676, 32-73004, 32-79431, 32-86036, 32-86036A1, 32-86036Q

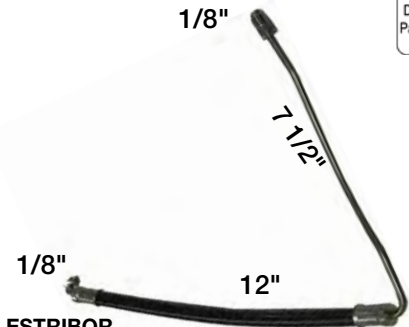

18-2105
LATIGUILLO TRIM ESTRIBOR
Reemplaza: 32-45973



18-2106
LATIGUILLO TRIM BABOR
Reemplaza: 32-45974



18-2107
LATIGUILLO TRIM
Reemplaza: 32-55816



18-2108
LATIGUILLO DE BOMBA A CONECTOR
Reemplaza: 32-59841, 32-59841A1, 32-73123



18-2109
LATIGUILLO TRIM
Reemplaza: 32-59842, 32-73005

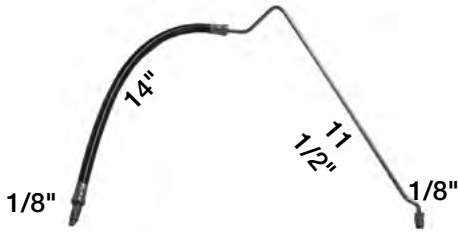

LATIGUILLO TRIM

Estribor
Conector al cilindro de trim inferior MCM 120-260 & BRAVO

Ref #	O.E. #	Descripción
18-2114	32-99902-1, 32-864960	Trim Cil. Casting #14034-1
18-2136*	32-99902, 32-864589	Trim Cil. Casting #98704, 98704-1

* Aproximadamente 11 1/4" largo

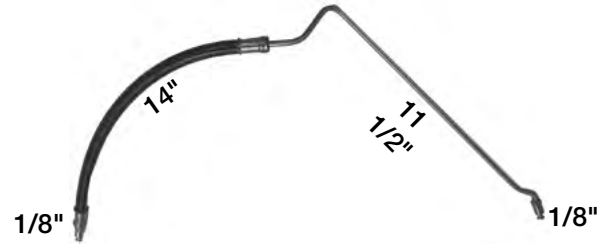

LATIGUILLO TRIM

Babor
Conector al cilindro de trim inferior MCM 120-260 & BRAVO

Ref #	O.E. #	Descripción
18-2115	32-99903-1, 32-864959	Trim Cil. Casting #14035-1
18-2137*	32-99903, 32-864588	Trim Cil. Casting #98703, 98703-1

* Aproximadamente 11 1/4" largo

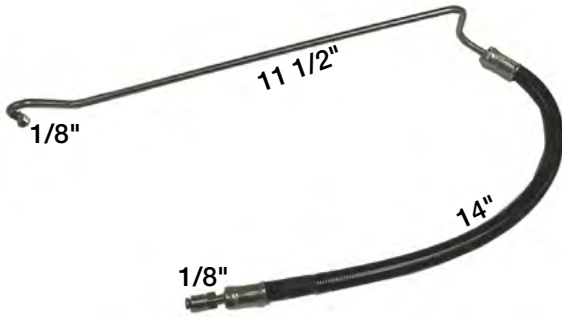

18-2112
LATIGUILLO TRIM BABOR
Reemplaza: 32-87234



18-2113
LATIGUILLO TRIM ESTRIBOR
Reemplaza: 32-87235



18-2435
LATIGUILLO POWER TRIM
Reemplaza: 32-861127, 32-95858
Para R/MR/Alpha/Alpha Gen II/Bravo I, II, III/Bravo X, XR, XZ
N° serie 0W099999 y post sin accesorios de conexión rápida
OEM color manguera negro.



18-2436
LATIGUILLO POWER TRIM
Reemplaza: 32-861128, 32-95859
Para R/MR/Alpha/Alpha Gen II/Bravo I, II, III/Bravo X, XR, XZ
N° serie 0W099999 y post sin accesorios de conexión rápida
OEM color manguera gris.



18-2116
LATIGUILLO TRIM
Reemplaza: 32-99904, 32-99904Q

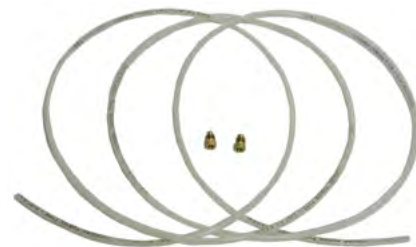

18-2126
LATIGUILLO TRIM
Reemplaza: 32-52951A1, 32-48418

APLICACIÓN MANGUERA POWER TRIM

Modelo Colas	Años	Nº serie	Cilindro de trim a conector (babor inferior)	Cilindro de trim a conector (babor superior)	Cilindro de trim a conector (estribor inferior)	Cilindro de trim a conector (estribor sup)	Bomba a conector hidráulico	Latiguillo bomba hidráulica	Conector a válvula reversa	Bomba hidráulica y válvula reversa
120, 140	1967-69	2062141 - 2791956	—	18-2106	—	18-2105	—	N/D	—	18-2126
120, 140	1970-73	2791957 - 3780849	18-2103	18-2103	18-2103	18-2103	18-2107	N/D	—	18-2126
120, 140	1974-82	4893635 - 6225576	18-2103	18-2103	18-2103	18-2103	18-2107	N/D	18-2109	18-2126
470/485	1976-82	4208730 - 6225576	18-2103	18-2103	18-2103	18-2103	18-2107	N/D	18-2109	18-2126
160	1967-69	2065190 - 2763441	—	18-2106	—	18-2105	—	N/D	—	18-2126
165	1970-73	2763442 - 3780849	18-2103	18-2103	18-2103	18-2103	18-2107	N/D	—	18-2126
165	1974-81	3780850 & SUP	18-2103	18-2103	18-2103	18-2103	18-2107	N/D	18-2109	18-2126
888	1974 & SUP	3106717 & SUP	18-2103	18-2103	18-2103	18-2103	18-2108	N/D	18-2109	—
225/233	1974-77	3856268 & SUP	18-2103	18-2103	18-2103	18-2103	18-2108	N/D	18-2109	—
228/898/250/260	1977-82	4782330 - 6225576	18-2103	18-2103	18-2103	18-2103	18-2108	N/D	18-2109	—
R/MR/Alpha/SS	1983-90	6225577 & SUP	18-2137 ③	18-2116	18-2136 ③	18-2116	18-2436⑤	18-2435⑤	N/D	N/D
R/MR/Alpha/SS	1983-90	6225577 & SUP	18-2115 ④	18-2116	18-2114 ④	18-2116	18-2436⑤	18-2435⑤	N/D	N/D
Alpha One GEN II	1991-97	D469859 & SUP	18-2115	18-2116	18-2114	18-2116	18-2436⑤	18-2435⑤	N/D	N/D
Alpha One GEN II ⑥	1998 & SUP	0L100040 & SUP	18-2115	18-2116	18-2114	18-2435	18-2436⑤	18-2435⑤	N/D	N/D
Bravo I, II & III ⑥	1988 & SUP	B664190 & SUP	18-2137	18-2116	18-2136	18-2116	18-2436⑤	18-2435⑤	N/D	N/D
Blackhawk	1994-95	F186717 & SUP	18-2137	18-2116	18-2136	18-2116	18-2436⑤	18-2435⑤	N/D	N/D
II (1.78)	1968-69	2398798 - 2671321	18-2103	18-2103	18-2103	18-2103	—	N/D	—	18-2126
III	1968-72	2373127 - 3002613	18-2103	18-2103	18-2103	18-2103	—	N/D	—	—
215E/H	1970-72	2909035 - 2915034	18-2103	18-2103	18-2103	18-2103	—	N/D	—	—
TR/TRS	1973-93	3377316 & sup	18-2103 ②	18-2103	18-2103 ②	18-2103	—	N/D	—	—
TR/TRS	1973-93	3377316 & sup	18-2103 ②	18-2103	18-2103 ②	18-2103	—	N/D	—	—
TR/TRS	1973-93	3377316 & sup	— ①	18-2103	— ①	18-2103	—	N/D	—	—

- ① Terminación en 90° ③ Estriado interior ⑤ 18-2436 OEM manguera color gris, 18-2435 OEM manguera color negro
 ② Estriado exterior ④ Bomba Oildyne ⑥ N° serie 0W099999 y post sin accesorios de conexión rápida

- ★ Caucho moldeado de alta calidad
- ★ Conector de manguera metálico con arandela de goma
- ★ Utiliza manguera estandar
- ★ Acabado dicromate resistente a la corrosión
- ★ Instalado en segundos
- ★ No necesarias herramientas

18-9010

TOMA AGUA REFORZADA



Limpia de sal y sedimentos los conductos del motor. Se fija fácilmente.

TUERCAS AUTOBLOCANTES INOX



Ref #	O.E. #	Rosca	Std. Pack.
18-3720 ③	11-34932	3/8" - 24	1
18-3721 ③	11-34933, 11-95702, 11-82671015, 11-46355, 11-33962, 11-29241, 11-24648, 11-22178, 11-21298	7/16" - 20	6
18-3722 ③	11-35888, 11-20361, 11-8267089	1/4" - 28	5
18-3723 ③	11-45592	5/16" - 24	1



18-9099

BLOQUEADOR DE COLAS

Reemplaza: 817019A1, 817019Q2, 817019A2, 879078, 86459A2, 86459A1, 86459, 41155A2, 41155A1, 32657A4, 32657A3

I.D. 3/4" x 11 1/8" longitud

Para todos ALPHA I, ALPHA Generación II, Bravo I, II, III, y Blackhawk



18-2372

CIERRE CILINDRO TRIM

Reemplaza: 88035

1.850 Diámetro

Para: R/MR/Alpha

Pack de 2



18-2465-9④

PAR DE PIVOTES

Reemplaza: 19-14842, 19-148421

Para: R/MR/Alpha One (1983-90)

nº serie. 6225577 y sup

I/II/III (1988-02) Nºserie. 6225577

Pack. de 2



18-2466-9④

PAR DE PIVOTES

Reemplaza: 19-815951

Para: Alpha One Gen II (1991-02)

Nº Serial. OD469859 y sup



18-2461

KIT PASADOR CILINDRO TRIM

Reemplaza: 17-44166T1

Para: Bravo I/II/III (1988-02)

NºSerial. 6225577 y sup



18-2462

KIT PASADOR CILINDRO TRIM

Reemplaza: 17-14873A1, 17-85056

Para: R/MR/Alpha One (1983-90)

Nº Serial. 6225577 y sup

③ Precio por pieza. Para pedir envasada, Añadir -9 a la referencia normal.

④ Precio por pack



18-2463
KIT PASADOR CILINDRO TRIM
Reemplaza: 17-14872A1, 17-99207
Para: R/MR/Alpha One (1983-90)
N° serie. 6225577 y sup (post.)



18-2464
KIT PASADOR FRONTAL Y POSTERIOR
Reemplaza: 17-815953T1, 56-864641A24,
56-18541A75, 17-8M0035070
Para: todos Alpha One Gen II



18-7633
KIT EMISOR TRIM
Reemplaza: 805320A03, 805320A1,
96863A15, 88678A5, 88678A4, 63115A12,
17693A2
Para: transmisiones MC-I, R, MR, Alpha, Alpha Gen II,
Bravo



18-2142
CILINDRO POWER TRIM
Reemplaza: 45706A1, 45706A3, 45706A6,
45706A8, 45706A12, 45706A14
Para Todos colas transmisión modelos con líneas
internas: 120, 140, 160, 165, 888, 898, 228, 225-S, 233,
250, 260,470 & 485



18-2148
ALOJAMIENTO CILINDRO TRIM
Reemplaza: 45523, 45706A4, 77442A1,
77443
Para Todas colas modelos: 120, 140, 160, 165, 888, 898,
228, 225-S, 233, 250, 260,470 & 485



18-2420
CILINDRO POWER TRIM
Reemplaza: 14034A3, 14034A5, 14034F1,
14034T, 14034T10
Para: R/MR/ALPHA (Estribor)



18-2421
CILINDRO POWER TRIM
Reemplaza: 14035A3, 14035A5, 14035F1,
14035T, 14035T10
Para: R/MR/ALPHA (babor)



18-2422
CILINDRO POWER TRIM
Reemplaza: 815935A7, 815935A3
Para: GEN II (babor) (S/N F680000 - SUP)



18-2423
CILINDRO POWER TRIM
Reemplaza: 815954A7, 815954A3
Para: GEN II (estribor)
(S/N F680000 - SUP)



18-2424
CILINDRO POWER TRIM
Reemplaza: 98703A11,
98703A12, 98703A17, 98703A26
Para: BRAVO (babor)



18-2425
CILINDRO POWER TRIM
Reemplaza: 98704A11,
98704A12, 98704A17,
98704A26, 8M0708280
Para: BRAVO (Estribor)



18-2426
CILINDRO POWER TRIM
Reemplaza: 98703A3
Para: R/MR/ALPHA (babor)



18-2427
CILINDRO POWER TRIM
Reemplaza: 98704A3
Para: R/MR/ALPHA (Estribor)

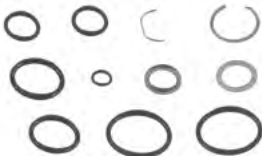

18-2649
KIT RETENES TRIM
Reemplaza: 25-87400A2



18-2291
KIT AROS TÓRICOS DE TRIM
Reemplaza: 25-60342A2,
25-60342A1
Para todas los modelos de colas: 120,
140, 160, 165, 888, 898, 228, 225-S, 233,
250, 260,470 & 485



18-2428
KIT REPARACIÓN CILINDRO TRIM
Reemplaza: 87399A2, 87399A1
Para: R/MR/ALPHA I, BRAVO



18-2429
KIT REPARACIÓN CILINDRO TRIM
Reemplaza: 87399A3
Para: ALPHA I GEN II

APLICACIÓN CILINDRO POWER TRIM

Modelo	Año	N° serie	Cilindro trim babor	Cilindro trim Estribor	Alojamiento babor	Alojamiento estribor	Kit retenes cilindro trim
120 / 140 4 cil	1967-1969	2062141-2791956	18-2142	18-2142	N/D	N/D	N/D
120 / 140	1970-1977	2791957-4893634	18-2142	18-2142	N/D	N/D	18-2291
120 / 140	1978-1982	4893635-6225576	18-2142 ④	18-2142 ④	N/D	N/D	18-2291
120 / 140	1978-1982	4893635-6225576	N/D ④	N/D ④	N.L.D	N.L.D	18-2291
160 6 cil	1967-1969	2062141-2791956	18-2142	18-2142	N/D	N/D	N/D
160	1967-1969	2065190-2763441	18-2142	18-2142	N/D	N/D	N/D
165	1970-1977	2763442-4890459	18-2142	18-2142	N/D	N/D	18-2291
165	1978-1981	4890460-4890459	18-2142 ④	18-2142 ④	N/D	N/D	18-2291
225 / 233	1974-1977	3856268 & SUP	18-2142	18-2142	N/D	N/D	18-2291
250	1977	4791300-4898729	18-2142	18-2142	N/D	N/D	18-2291
260	1978-1982	4898730-6225576	18-2142 ④	18-2142 ④	N/D	N/D	18-2291
470 / 485	1976-1977	4208730-4893934	18-2142	18-2142	N/D	N/D	18-2291
470 / 485	1978-1982	4893835-6225575	18-2142 ④	18-2142 ④	N/D	N/D	18-2291
898 / 228	1977	4782330-4898729	18-2142	18-2142	N/D	N/D	18-2291
898 / 228	1978-1982	4898730-6225576	18-2142 ④	18-2142 ④	N/D	N/D	18-2291
Todos # 1 DRIVES ④	1970-1982	2791957-6225576	18-2142	18-2142	18-2148	18-2148	18-2291
R / MR / ALPHA I	1983-1990	6225577-D469858	18-2426 ①	18-2427 ①	N/D ⑤	N/D ⑦	18-2649
R / MR / ALPHA I	1983-1990	6225577-D469858	18-2426 ①	18-2427 ①	N/D ⑥	N/D ⑧	18-2649
R	1983-1990	6225577 & SUP	18-2426 ①	18-2427 ①	N/D	N/D	18-2649
MR	1983-1990	6225577 & SUP	18-2426 ①	18-2427 ①	N/D	N/D	18-2649
ALPHA I	1983-1990	6225577 & SUP	18-2426 ①	18-2427 ①	N/D	N/D	18-2649
ALPHA I SS	1986-1989	A545004 & SUP	18-2426 ①	18-2427 ①	N/D ⑤	N/D ⑦	18-2649
ALPHA I SS	1986-1989	A545004 & SUP	18-2421 ②	18-2420 ②	N/D	N/D	18-2649
ALPHA I SS	1986-1989	A545004 & SUP	18-2422	18-2423	N/D	N/D	18-2649
R	1983-1990	6225577 & SUP	18-2421 ②	18-2420 ②	N/D	N/D	18-2649
MR	1983-1990	6225577 & SUP	18-2421 ②	18-2420 ②	N/D	N/D	18-2649
ALPHA I	1983-1990	6225577 & SUP	18-2421 ②	18-2420 ②	N/D	N/D	18-2649
ALPHA I GEN II	1991-2001	D469859 & SUP	18-2422	18-2433	N/D	N/D	18-2649
BRAVO I	1988-2010	B664190 & SUP	18-2424	18-2425	N/D	N/D	18-2649
BRAVO II	1988 & SUP	B664190 & SUP	18-2424	18-2425	N/D	N/D	18-2649
BRAVO III	1988 & SUP	B664190 & SUP	18-2424	18-2425	N/D	N/D	18-2649
BRAVO SEACORE	2007-2010	W900000 & SUP	N/D	N/D	N/D	N/D	18-2649
BLACKHAWK	1994-1995	F186717 & SUP	18-2424	18-2425	N/D	N/D	18-2649

- | | | |
|------------------------------------------------------|-----------------------------------------------|---------------------------------------------------------|
| ① 11 3/8" TUBOS LARGOS - LÍNEAS DEL CILINDRO INTERNO | ② 13 3/4" TUBOS LARGOS - LINEAS TRIM INTERNAS | ③ FUNDICIÓN #14034 1 |
| ④ CASTING 14035 1 | ⑤ CASTING #98703 | ⑥ FUNDICIÓN #98703 1 |
| ⑦ CASTING #98704 | ⑧ CASTING #98704 1 | ⑨ ESTRIAS EXTERNAS TRIM |
| ⑩ ESTRIAS INTERNAS TRIM | ⑪ USAR CON 15 9/16" CILINDRO TUBO LARGO TRIM | ⑫ USAR CON 16 3/16" CILINDRO TUBO LARGO TRIM |
| ⑬ CILINDROS TRIM CON LINEAS DE TRIM INTERNAS | ⑭ CILINDROS TRIM CON LINEAS DE TRIM EXTERNAS | ⑮ EXCLUYE TR, TRS, 215E, H, & ANT. II & III TRANSMISIÓN |

Pack de 5



18-4252
18-4252-9⑦
MUELLE DE CONTINUIDAD
Reemplaza: 24-46312
Sujeta el cilindro trim al pivote del eje.



18-2151
7 1/2" (Frontal)
Reemplaza: 17-45738

18-2152
10 1/2" (Trasero)
Reemplaza: 17-45735

PASADOR PIVOTE
Usado en 120, 120-260, 140, 165, 225S, 233, 250, 470, 888, 898/228
Usa casquillo 18-2701



18-2393
PASADOR PIVOTE
Reemplaza: 17-14872
Para: Trim cilindero trasero R/MR/Alpha
Usa: Casquillo 18-2702-1



18-2394
PASADOR PIVOTE
Reemplaza: 17-14873
3/8" - 24 rosca
Para: Trim cilindro frontal R/MR/Alpha
Usa: casquillo 18-2702-1



18-2395
PASADOR PIVOTE
Reemplaza: 17-815953, 17-815953A1
Para: Trim cilindro frontal & trasero Gen II



18-2396
PASADOR PIVOTE
9 1/4" longitud • 7 1/2" longitud del eje
Reemplaza: 17-44166
Para: Bravo trasero













18-2397
PASADOR PIVOTE
Reemplaza: 17-44167A1, 17-44167
Para: Frontal Bravo

- ④ Pack estándar precio por pieza 8
⑤ Pack estándar de 8 precio por pack ⑥ Precio por pack de 4
⑦ Precio por pack

 <p>CASQUILLO POWER TRIM 18-2701^⑤ 18-2701-04^⑥ 18-2701-9^④ Reemplaza: 23-89574, 23-61290, 23-45736 Para unidad transmisión 120/260 (S/N 6225276 & inferiores)</p>	 <p>CASQUILLO POWER TRIM 18-2702-1^⑤ 18-2702-04^⑥ 18-2702-1-9^④ Reemplaza: 23-99291, 23-99291T Para unidad transmisión 120/260 (S/N 6225277 & SUP)</p>	 <p>PACK. DE 8 18-4288 18-4288-9^⑦ CASQUILLO POWER TRIM Reemplaza: 23-807073, 23-44165 Para: Bravo</p>	 <p>18-2345 18-2345-9^⑦ ARO RETENEDOR CILINDRO TRIM Reemplaza: 53-815949 Para: Gen II</p>
<p>Pack. de 2</p>  <p>18-4289 18-4289-9^⑦ ARO RETENEDOR Reemplaza: 53-805272 Para: Bravo</p>	<p>Pack. de 4</p>  <p>18-2336 18-2336-9^⑦ CASQUILLO POWER TRIM Reemplaza: 23-47392, 23-61291, 23-90203 Para: TR & TRS(1977-93), Alpha One SS (1986-1989), SSM(1982-1995)</p>	<p>Pack. de 8</p>  <p>18-2341-1 18-2341-1-9^⑦ CASQUILLO POWER TRIM Reemplaza: 23-815950, 23-8159501, 23-815950Q01 Para: Gen II</p>	<p>Pack de 5</p>  <p>18-3232 18-3232-9^⑦ TAPÓN Reemplaza: 19-47579, 19-475791 Para: MR Alpha</p>

EL ZINC es sólo para aplicaciones en agua salada.
EL MAGNESIO es sólo para aplicaciones en agua dulce..
EL ALUMINIO es para ser usado tanto en agua dulce como en agua salada.

 <p>603065 Al 18-6154M Mag 025534 Zinc KIT ANODO Bravo III (2004 y nuevos)</p>	 <p>18-6158M Mag 025532 Zinc 603062 Al KIT ANODO Reemplaza: 888755Q01 (18-6158M), 888756Q01 (18-6158A), 97-888756Q03 (18-6158A, M), 888756A1 (18-6158A, M) Mercuriser Alpha I Gen II (1991 & SUP)</p>	 <p>603063 Al 18-6159M Mag 025531 Zinc KIT ANODO Reemplaza: 888758Q01 (18-6159A), 888757Q01 (18-6159M), 97-888758Q03 (18-6160A), 888758A1 (18-6160A), 97-888759Q03 (18-6160M), 888759A1 (18-6160AM) Mercuriser Bravo I - Todos años</p>	
 <p>603064 Al 18-6160M Mag 025379 Zinc KIT ANODO Reemplaza: 888761Q01 (18-6160A), 97-888761Q03 (18-6160A), 888761A1 (18-6160A), 888760Q01 (18-6160M), 97-888760Q03 (18-6160M), 888760A1 (18-6160M) Bravo II (1989 & sup), Bravo III (1989-03)</p>	 <p>025441 Zinc ÁNODO Reemplaza: 762144 Proa Mercury Bravo One, Bravo II-III 2004.</p>	 <p>② 18-6241M Mag ③ 009354 Zinc ① 603041 Al ÁNODO Reemplaza: 31640, 31640A1, 97-31640Q4, 31640T6, 97-31640B4, 31640A4, 31640A2, 316404, 316403, 72436A1 Para usar en R/MR/Alpha One, colas & Transom Assembly (1983-90) & prior drives, Alpha One, Gen II (1991 & sup)</p>	 <p>③ 009353 Zinc ÁNODO Reemplaza: 34127A1, 34127T2, 34127A2, 34127T1, 34127 Para usar en R/MR/Alpha One (colas & Transom Assembly 1983-90) & anteriores</p>
 <p>③ 025300 Zinc ÁNODO Reemplaza: 34762A1, 97-34672C, 32170, 32170A1 Para usar en Alpha One SS (Colas & Transom) & anteriores</p>	 <p>③ 025849 Zinc ① 18-6014A Al ÁNODO Reemplaza: 46399A1, 822777A1, 822777Q1, 822777A4, 822777A3, 8227772, 822777, 463999A2 Para usar en Alpha One SS (1982-89)</p>	 <p>③ 025407 Zinc ÁNODO Tuerca para Mercuriser Alpha One.</p>	

① Aluminio ② Magnesio ③ Zinc ④ Pack estandard 10 precio por pieza ⑤ Pack estándar 10 precio por pack
⑥ Pack estándar 2 precio por pack

El ZINC es sólo para aplicaciones en agua salada.
 El MAGNESIO es sólo para aplicaciones en agua dulce..
 El ALUMINIO es para ser usado tanto en agua dulce como en agua salada.



① 603047 Al
 ③ 009321 Zinc
 ⑥ ② 18-6242 Mag
ÁNODO
 Reemplaza: 55989A3, 55989Q9,
 55989T9, 55989A9, 55989A4,
 55989
 Bravo I, II, III (1988-95)



① 603046 Al
 ② 18-6244M Mag
 ③ 009371 Zinc
ÁNODO
 Reemplaza: 76214, 762142, 762142A1,
 76214A5, 97-76214Q5, 786214A2,
 97-762145,
 200, 225, 250HP, V-155-V-200, & Todos Bravos, Alpha
 One, Gen II (1991 & sup) (roscado)



① 603042 Al
 ② 18-6243M Mag
 ③ 009365 Zinc
ÁNODO
 Reemplaza: 43994A2,
 821631Q1, 821631C,
 821631B1, 821631A1
 Para usar en R/MR/Alpha One (Colas &
 Transom 1983-90)



① 603039 Al
 ② 18-6114M Mag
 ③ 009320 Zinc
ÁNODO
 Reemplaza: 97-806189,
 806189A1, 97-806189Q1
 Para: Alpha One, Gen II (1991 & sup)



① 603048 Al
 ③ 009464 Zinc
ÁNODO
 Reemplaza: 826134,
 826134A1, 97-826134Q,
 Alpha One (Gen II)



① 603038 Al
 ② 18-6099M Mag
 ③ 025845 Zinc
ÁNODO
 Reemplaza: 815933A1,
 821629A1, 97-821629Q1
 Para: Alpha One (Gen II) (1991 & SUP)



① 603044 Al
 ② 18-6089M Mag
 ③ 009372 Zinc
ÁNODO
 Reemplaza: 97-806190, 806190A1,
 97-806190Q1, 806190T1,
 97-806190B4,
 Todos Bravos



① 603040 A
 ② 18-6079M Mag
 ③ 009369 Zinc
ÁNODO
 Reemplaza: 806105, 806105A1, 806105Q1,
 806105T1
 Para: Alpha One (Gen II) (1991 & SUP)



① 603061 Al
 ② 18-6150M Mag
 ③ 18-6150 Zinc
KIT ÁNODO
 Reemplaza: 888756Q02, 888756Q4,
 888756A2
 Para: MR & Alpha One Drives



① 603043 Al
 ② 18-6240M Mag
 ③ 025298 Zinc
ÁNODO
 Reemplaza: 821630C2, 821630A1,
 97-821630Q1, 817373A1
 Todos Bravos



① 603050 Al
 ③ 009468 Zinc
ÁNODO
 Reemplaza: 865182A1.
 Para Hélice Bravo 3.
 Para 2003 y anteriores



① 603157 Al
KIT ÁNODO Bravo 3.
 Para 2003 y anteriores



① 603045 Al
 ② 18-6117M Mag
 ③ 025424 Zinc
ÁNODO
 Reemplaza: 97-806188A1,
 97-806188Q01
 Para: Bravo One bearing carrier

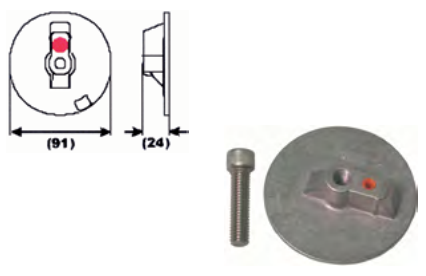

① 603096 Al
ÁNODO
 Para Bravo 3. (2003 y posteriores).
 Para barra Trim doble. Reemplaza: 762144



① 603162 Al
ÁNODO
 Para Bravo 3. (2003 y anteriores).



ZINETI, S.A.U. KZ-MERCALPHI1
 PROTECTION AGAINST CORROSION
 Kit of zinc anodes for:
 Mercury / Mercruiser
 Alpha One GEN I
www.zineti.com
 ③ 025525 Zinc
KIT ÁNODO. Para Alpha I Gen I

① Aluminio ② Magnesio ③ Zinc ④ Pack estándar 10 precio por pieza ⑤ Pack estándar 10 precio por pack
 ⑥ Pack estándar 2 precio por pack

— CONTIENE —

Ref #	Desc.	O.E.#	Cant.
18-2599	Retén y herramienta	26-818575A2	1
18-2564	Junta		
		27-43033-1	1
18-2566	Junta		
		27-817277	1
18-2945	Arandela	12-19183	1
18-2944	Retén	26-45577	1
18-2002	Retén aceite	26-30550, 26-76868	1
18-2009	Retén aceite	26-892361	1
18-2013	Retén aceite	26-16977	1
18-2014	Retén aceite	26-89238	1
18-2054	Retén aceite	26-81646-1	1
18-2056	Retén aceite	26-965031	2
18-2076	Retén aceite	26-12224	1
18-2077	Retén aceite	26-14077	1
18-7159	Aro tórico	25-31534	1
18-7168	Aro tórico	25-48171	2
18-7176	Aro tórico	25-90011	1
18-7420	Aro tórico	25-21836	2
18-7440-1	Aro tórico	25-36318	2
18-2056	Retén aceite	26-66302	2
18-7413	Aro tórico	25-62702	1



18-2646-1
KIT RETENES PARTE INFERIOR
Reemplaza: 26-816575A3, 26-816575A1
Para: Alpha Gen II

— CONTIENE —

Ref #	Descripción	O.E. #	Cant.
18-2516	Retén	16755	1
18-1240	Retén	12708	1
18-2945	Junta	12-19183	1
18-7198	Aro tórico	25-45710	1
18-7102	Aro tórico	25-62706	1
18-7105	Aro tórico	25-62705	1
18-7449	Aro tórico	25-97387	1
18-7153	Aro tórico	25-25439	2
18-7167	Aro tórico	25-97386	1
18-2010	NSS	26-12709	1
18-2715	Kit muelles	24-17997A1	1
18-7117	Aro tórico	25-35027	1
18-7169	Aro tórico	25-70937	1



18-2643
KIT RETENES UNIDAD SUPERIOR
Reemplaza: 26-16709A2, 26-16709A1
BRAVO - BLACKHAWK

— CONTIENE —

Ref #	Desc.	O.E. #	Cant.
18-2944	Junta retén	26-45577	1
18-2945	Junta	12-19183	3
18-7188	Aro drenaje	26-805726	1
18-7169	Aro tórico	25-70937	1
18-7161	Aro tórico	25-32546	1
18-7420	Aro tórico	25-25439	2
18-7103	Aro tórico	25-29845	2
18-7117	Aro tórico	25-35027	1
18-2056	Retén aceite	26-965031	2
18-2003	Retén aceite	26-68493, 26-32080, 26-36054, 26-823894	1
NSS	Junta tubo de agua	26-88397	1
18-3289	Retén doble labio	26-864319	1
18-2715	Kit muelles	24-17997A1	1



18-2644
KIT RETENES ALOJAMIENTO
Reemplaza: 26-88397A1
ALPHA I GENERATION II

NSS= No se venden por separado.

APLICACIÓN KIT DE RETENES EMPIEZAN EN LA PÁGINA 192

-- CONTIENE --

Ref #	Descripción	O.E. #	Cant.
18-2944	Junta retén	26-45577	1
18-2945	Junta	12-19183	1
18-7163	Aro tórico	25-33465	1
18-7159	Aro	25-31534	1
18-2002	Retén aceite	26-70019, 26-73838	2
18-0563	Retén	26-36556	1

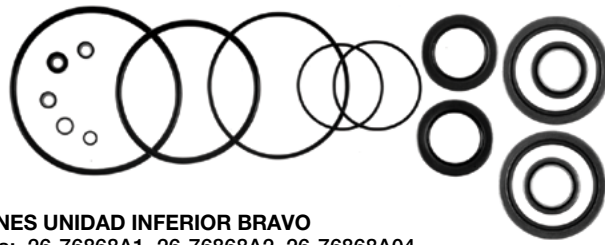

18-2645
KIT RETENES UNIDAD INFERIOR BRAVO
 Reemplaza: 26-76868A1, 26-76868A2, 26-76868A04
 Bravo I, II & III MODELOS

-- CONTIENE --

Ref #	Descripción	O.E. #	Cant.
18-2945	Junta tornillo aloj. engranaje	12-19183	2
18-0894	Junta tapa agua	27-55810	1
18-2003	Retén aceite	26-823894	1
18-2049	Retén aceite	26-32511	1
18-2056	Retén aceite	26-965031	1
18-2944	Aro tórico	26-45577	1
18-3110	Cojinete	26-38970	1
18-7153	Aro tórico	25-25439	2
18-7161	Aro tórico	25-32546	1
18-7169	Aro tórico	25-70937	1
18-7445	Aro tórico	25-55801	1

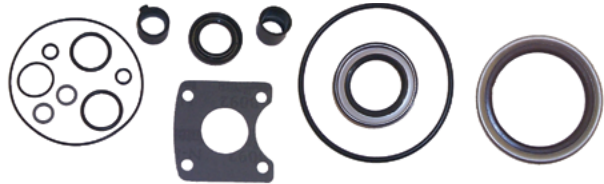

18-2648
KIT RETENES ENGRANAJES SUP
 Reemplaza: 26-32511A1
 S/N 1684188 & SUP
 Para #1 Units (Incluye ALPHA) (También se adapta 888 colas)
 S/N 3106717 & SUP

-- CONTIENE --

Ref #	Descripción	O.E. #	Cant.
18-2919	Junta alojamiento a base bomba	27-42631-1	1
18-3110	Casquillo	26-38970	1
18-2002	Retén aceite	26-70019, 26-73838	1
18-2013	Retén aceite	26-16977	2
18-2014	Retén aceite	26-89238	1
18-2826	Junta aloj. engranajes a base bomba	27-85610-1	1
18-2914	Junta platina desgaste a bomba agua	27-85608-1	1
18-2915	Junta platina desgaste a bomba agua	27-85609-1	1
18-2944	Aro tórico	26-45577	1
18-2948	Junta	12-49221-1	1
18-7158	Aro tórico	25-30613	1
18-7159	Aro tórico	25-31534	1
18-7162	Aro tórico	25-33145	1
18-7176	Aro tórico	25-90011	1
-	Aro tórico	25-38099	1
18-2154	Casquillo eje inverso	23-30617A2	1
18-2076	Retén	26-12224	1
18-7426	Aro tórico	25-30271	1
18-2945	Junta	12-20260, 12-19183	2

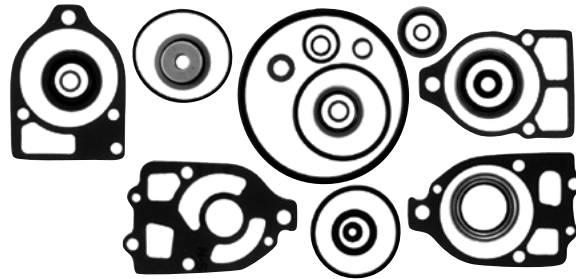

18-2652
KIT RETENES ENGRANAJES INFERIOR
 Reemplaza: 26-33144A2, 26-33144A1, 26-89238A1
 S/N 1684188 & SUP
 Para #1 Unidades (Incluyendo ALPHA)

-- CONTIENE --

Ref #	Descripción	O.E. #	Cant.
18-2652	Kit retenes parte inferior	26-33144A2	1
18-1155	Cojinete a bolas	30-88957A1	1
18-1117	Cojinete piñón	31-42647A1	1
18-1143	Cojinete rodillos	31-36387A1	1
18-3719	Tuerca piñón	11-35921	1
18-2299	Arandela	14-79447	1
18-2298	Arandela	14-18323	1
18-1158	Cojinete agujas	31-30956	1
18-1159	Cojinete rodillos	31-35928A1	1
18-2285	Kit gruesos	15-47397A1	1
18-1157	Cojinete agujas	31-30895	1
18-2343	Arandela	12-982721	1
18-2294	Kit gruesos	2470	1



18-8208
KIT RETENES Y COJINETES
 Reemplaza: 31-803090T1
 Para: MR/Alpha Drive

-- CONTIENE --

Ref #	Descripción	O.E. #	Cant.
18-2340	Arandela	12-31266	1
18-2076	Retén aceite	26-12224	1
18-7159	Retén aceite	25-31534	1
18-2002	Retén aceite	26-76868	1
18-3109	Tubo agua	23-29804	1
18-2154	Aloj.Cojinete	23-30617A2	1
18-3116	Alojamiento	46-96148A1	1
18-3017	Impulsor	47-89984	1
18-2914	Junta bomba agua	27-85608-1	1
18-7158	Aro tórico	25-30613	1
18-7176	Aro tórico	25-90011	1
18-2944	Junta aro retén	26-45577	1
18-7173	Aro tórico	25-30224	1
18-2826	Junta aloj. engranajes a base bomba	27-85610-1	1
18-2915	Junta bomba agua	27-85609-1	1
18-3117	Platina	32435	1
18-7162	Aro tórico	25-33145	1
18-2919	Junta bomba agua	27-42631-1	1
18-2801	Junta bomba agua	27-32438	1
18-7426	Aro tórico	35-30271	1
18-2945	Junta drenaje	26-20260, 12-19183	2
18-3110	Casquillo	26-38970	1
18-2013	Retén	26-16977	1
18-2014	Retén	26-89238	1



18-8370
KIT REACONDICIONAMIENTO COMPLETO CAJA ENGRANAJES
 Incluye bomba de agua y kit completo de retenes
 Para Mercuriser R/MR/ALPHA 1

Modelo	Año	Desde nº serie #	Hasta nº serie #	Kit Retenes	Retén	Asiento Retén	Kit Retén	Kit Retén aloj. eng.	Aro Coj.	Retén
60 / 80 / 90	1965-1972	1830753	3225967	N/D	N.L.A.	N/D	N/D	N/D	18-7160	18-2011
IA / IB / IC / EZ SHIFT	1964-1966	1684188	2065186	18-2648	18-2003	18-0577	N/D	18-2652	18-7159	18-2002
120 / 140	1967-1982	2062141	6225576	18-2648	18-2003	18-0577	N/D	18-2652	18-7159	18-2002
470 / 485	1976-1982	4208730	6225575	18-2648	18-2003	18-0577	N/D	18-2652	18-7159	18-2002
160 / 165	1967-1981	2065190	& SUP	18-2648	18-2003	18-0577	N/D	18-2652	18-7159	18-2002
888	1971-1977	3106717	& SUP	18-2648	18-2003	18-0577	N/D	18-2652	18-7159	18-2002
225 / 233	1974-1977	3856268	& SUP	18-2648	18-2003	18-0577	N/D	18-2652	18-7159	18-2002
888 / 228 / 250 / 260	1977-1982	4782330	6225576	18-2648	18-2003	18-0577	N/D	18-2652	18-7159	18-2002
R	1983	6225577	& SUP	18-2648	18-2003	18-0577	N/D	18-2652	18-7159	18-2002
MR ALPHA ONE	1984-1990	6225577	D469858	18-2648	18-2003	18-0577	18-8208	18-2652	18-7159	18-2002 ③
MR ALPHA ONE	1984-1990	6225577	D469858	18-2648	18-2003	18-0577	18-8208	18-2652	18-7159	18-2077 ①
MR ALPHA ONE	1984-1990	6225577	D469858	18-2648	18-2003	18-0577	18-8208	18-2652	18-7159	18-2076 ②
MR ALPHA ONE (CR)	1984-1990	6225577	D469858	18-2648	18-2003	18-0577	N.L.A.	18-2652	18-7159	18-2077 ①
MR ALPHA ONE (CR)	1984-1990	6225577	D469858	18-2648	18-2003	18-0577	N.L.A.	18-2652	18-7159	18-2076 ②
ALPHA ONE SS	1986-1989	A545004	& SUP	18-2648	18-2003	18-0577	N/D	18-2652	18-7159	18-2002 ③
ALPHA ONE SS	1986-1989	A545004	& SUP	18-2648	18-2003	18-0577	N/D	18-2652	18-7159	18-2077 ①
ALPHA ONE SS	1986-1989	A545004	& SUP	18-2648	18-2003	18-0577	N/D	18-2652	18-7159	18-2076 ②
APLHA ONE GEN II	1991-1995	D469859	F679999	18-2644	18-2003	18-0577	N/D	18-2646-1	18-7159	18-2077 ①
APLHA ONE GEN II	1991-1995	D469859	F679999	18-2644	18-2003	18-0577	N/D	18-2646-1	18-7159	18-2076 ②
APLHA ONE GEN II (CR)	1991-1995	D469859	F679999	18-2644	18-2003	18-0577	N.L.A.	18-2646-1	18-7159	18-2077 ①
APLHA ONE GEN II (CR)	1991-1995	D469859	F679999	18-2644	18-2003	18-0577	N.L.A.	18-2646-1	18-7159	18-2076 ②
APLHA ONE GEN II	1996-1997	F680000	K999999	18-2644	18-2003	18-0577	N/D	18-2646-1	18-7159	18-2077 ①
APLHA ONE GEN II	1996-1997	F680000	K999999	18-2644	18-2003	18-0577	N/D	18-2646-1	18-7159	18-2076 ②
APLHA ONE GEN II (CR)	1996-2010	F680000	& SUP	18-2644	18-2003	18-0577	N.L.A.	18-2646-1	18-7159	18-2077 ①
APLHA ONE GEN II (CR)	1996-2010	F680000	& SUP	18-2644	18-2003	18-0577	N.L.A.	18-2646-1	18-7159	18-2076 ②
APLHA ONE GEN II	1998-2010	L100040	& SUP	18-2644	18-2003	18-0577	N/D	18-2646-1	18-7159	18-2077 ①
APLHA ONE GEN II	1998-2010	L100040	& SUP	18-2644	18-2003	18-0577	N/D	18-2646-1	18-7159	18-2076 ②
BRAVO I	1988-2010	B664190	& SUP	18-2643	N/D	N/D	N/D	18-2645	18-7159	18-2002
BRAVO I X	2000-2010	M100001	& SUP	18-2643	N/D	N/D	N/D	18-2645	18-7159	18-2002
BRAVO I XR/XZ	2000-2010	M100001	& SUP	18-2643	N/D	N/D	N/D	N/D	18-7159	N/D
BRAVO II	1988-2010	B664190	& SUP	18-2643	N/D	N/D	N/D	18-2645	N/D	N/D ②
BRAVO II	1988-2010	B664190	& SUP	18-2643	N/D	N/D	N/D	18-2645	N/D	N/D ①
BRAVO II X	2000-2010	M100001	& SUP	18-2643	N/D	N/D	N/D	18-2645	N/D	N/D ②
BRAVO II X	2000-2010	M100001	& SUP	18-2643	N/D	N/D	N/D	18-2645	N/D	N/D ①
BRAVO III	1988-2010	B664190	& SUP	18-2643	N/D	N/D	N/D	18-2645	N/D	N/D
BRAVO III X	2000-2010	M100001	& SUP	18-2643	N/D	N/D	N/D	18-2645	N/D	N/D
BLACKHAWK	1994-1995	F186717	& SUP	18-2643	N/D	N/D	N/D	N/D	N/D	N/D
I	1963	1534570	1684187	18-2648	N/D	18-0577	18-2652	N/D	18-7157	18-2002
II	1962-1969	1474909	2671321	N/D	N/D	N/D	N/D	N/D	18-7159	N.L.A.
III	1968-1972	2373127	3002613	N/D	N/D	N/D	N/D	N/D	N/D	N/D
215E/H	1970-1972	2909035	2915034	N/D	N/D	N/D	N/D	N/D	N/D	N/D
TR	1973-1993	3377316	& SUP	N/D	N/D	N/D	N/D	N/D	N/D	N/D
TRS	1973-1993	3377316	& SUP	N/D	N/D	N/D	N/D	N/D	18-7159	N/D

① Interno ② Externo ③ Sin retén

<p>② 18-4456D</p>  <p>18-4456 TAPA ESCAPE Reemplaza: 34765A1, 34765A2 INCLUYE ABRAZADERA DE ACERO INOXIDABLE 3"</p>	<p>② 18-4457D</p>  <p>18-4457 TAPA ESCAPE Reemplaza: 12644A1, 12644Q01 INCLUYE ABRAZADERA ACERO INOXIDABLE 4"</p>	<p>② 18-4458D</p>  <p>18-4458 TAPA ESCAPE (Para escapes de 5" y 6") INCLUYE ABRAZADERA ACERO INOX</p>
----------------------------------------------------------------------------------------------------------------------------------------------------------------------------------------------------------------------------------	--------------------------------------------------------------------------------------------------------------------------------------------------------------------------------------------------------------------------------	----------------------------------------------------------------------------------------------------------------------------------------------------------------------------------------------------------------------

② Referencias acabadas en "D" envasadas - Referencias normales no envasadas

RETÉN ACEITE

Ref #	O.E. #	Diámetro Eje (Pulgadas.)	Dimensiones (pulg.)			Ref #	O.E. #	Diámetro Eje (Pulgadas.)	Dimensiones (pulg.)	
			D.E.	Ancho					D.E.	Ancho
18-0172	26-97530	0.845	1.500	0.315						
18-0515	26-30530	0.540	1.004	0.303						
18-0516	26-30913	0.500	0.839	0.187						
18-0517	26-32911	1.100	1.260	0.127						
18-0519	26-14240	3.792	4.536	0.482						
18-0522	26-43036	1.045	1.474	0.187	18-2013	26-16977	0.875	1.25	0.188	
18-0523	26-43993	1.640	2.132	0.282	18-2014	26-89238	0.875	1.5	0.312	
18-0525	26-45587	0.390	0.628	0.124	18-2015	26-23517	0.75	1.25	0.25	
18-0526	26-48443	0.750	1.379	0.256	18-2016	26-41953	1.187	1.875	0.25	
18-0527	26-56397	0.750	1.127	0.343	18-2017	26-32121	0.75	1	0.125	
18-0529	26-62818	1.640	2.256	0.319	18-2019	26-27163	0.688	1.124	0.25	
18-0531	26-72785	0.790	1.880	0.248	18-2026 ①	26-16977	0.875	1.25	0.188	
18-0537	26-85107	1.020	1.507	0.251	18-2048	26-24590	0.4	0.566	0.094	
18-0578	26-67388	1.800	3.100	0.500	18-2049	26-32511	1.25	2.005	0.388	
18-2002	26-76868	1.188	1.692	0.25	18-2050	26-55682	1	1.253	0.125	
18-2004	26-20070	0.625	1	0.25	18-2051	26-69188	0.875	1.253	0.278	
18-2003	26-823894	2.25	3	0.437	18-2052	26-69189	0.875	1.314	0.322	
18-2004	26-20070	0.625	1	0.25	18-2053	26-70081	1.185	1.754	0.36	
18-2006	26-897154	0.625	1.125	0.312	18-2054	26-8164641	0.375	0.75	0.243	
18-2007	26-94038	1	1.5	0.312	18-2055	26-79831	0.75	1.127	0.149	
18-2008	26-56788	0.875	1.25	0.375	18-2056	26-965031	0.875	1.375	0.250	
18-2009	26-892361	0.375	0.75	0.25	18-2076 ①	26-12224	1.188	1.690	0.360	
18-2010	26-897153	0.437	0.875	0.25	18-2077	26-14077	1.188	1.689	0.247	
18-2011	26-90562	0.75	1.25	0.312	① Retén lineal					

Retén aceite
MERCURISER

ALOJAMIENTO TRANSMISIÓN

Modelo Cola	desde. S/N	hasta. S/N	Retén Aceite	Desc.	Cant.	Modelo Cola	Desde. S/N	Hasta. S/N	Retén Aceite	Desc.	Cant.
R/MR/Alpha I	6225577	SUP	18-2003	BC	1	250	4791300	4898729	18-2003	BC	1
Alpha I SS		Todos	18-2003	BC	1	250	4791300	4898729	18-2056	LDS	1
Alpha I SS		Todos	18-2056	LDS	1	260	4898730	6225576	18-2049	GC	1
Alpha I SS		Todos	18-2049	GC	1	260	4898730	6225576	18-2056	LDS	1
IA,IB,IC	1684188	2065189	18-2003	BC	1	260	4898730	6225576	18-2003	BC	1
I,IA,IB,IC	1534570	2065189	18-2049	GC	1	470	4208730	6225576	18-2056	LDS	1
IA,IB,IC	1749276	2065189	18-2056	LDS	1	470	4208730	6225576	18-2003	BC	1
II	1474909	2671321	18-2003	BC	1	470	4208730	6225576	18-2049	GC	1
120/140	2062141	6225576	18-2003	BC	1	485	4893835	SUP	18-2003	BC	1
120/140	2062141	6225576	18-2056	LDS	1	485	4893835	SUP	18-2049	GC	1
120/140	2062141	6225576	18-2049	GC	1	485	4893835	SUP	18-2056	LDS	1
160/165	2065190	SUP	18-2003	BC	1	888	3106717	SUP	18-2056	LDS	1
160/165	2065190	SUP	18-2049	GC	1	888	3106717	SUP	18-2049	GC	1
160/165	2065190	SUP	18-2056	LDS	1	888	3106717	SUP	18-2003	BC	1
225-S	3856268	4200499	18-2056	LDS	1	898/228	4782330	6225576	18-2049	GC	1
225-S	3856268	4200499	18-2049	GC	1	898/228	4782330	6225576	18-2003	BC	1
225-S	3856268	4200499	18-2003	BC	1	898/228	4782330	6225576	18-2056	LDS	1
233	4200500	SUP	18-2049	GC	1	BC Retén cojinete GC Retén engranaje LDS Retén eje dirección inferior					
233	4200500	SUP	18-2003	BC	1						
233	4200500	SUP	18-2056	LDS	1						
250	4791300	4898729	18-2049	GC	1						

ALOJAMIENTO ENGRANAJE

Modelo Cola	Desde. S/N	hasta. S/N	Retén aceite	Desc.	Cant.	Modelo Cola	Desde. S/N	Hasta. S/N	Retén Aceite	Desc.	Cant.
MR/Alpha I	6225577	SUP	18-2002	PS	2	IA,IB,IC	1684188	2065189	18-2014	WPB	1
R/MR/Alpha I	6225577	SUP	18-2009	SSB	1	IA,IB,IC	1684188	2065189	18-2002	PS	2
R/MR/Alpha I	6225577	SUP	18-2014	WPB,L	1	IA,IB,IC	1684188	2065189	18-2013	WPB	1
MR/Alpha I	6225577	SUP	18-2013	WPB,U	1	IA,IB,IC	1684188	2065189	18-2013	WP	1
R	6225577	SUP	18-2013	WPB,U	1	IA,IB,IC	1684188	2065189	18-2009	SSB	1
Alpha I SS	TODOS		18-2014	WPB,L	1	TRS	4794900	SUP	18-2002	PS	2
Alpha I SS	TODOS		18-2009	SSB	1	60	1830753	2063740	18-2009	SSB	1
Alpha I SS	TODOS		18-2013	WPB,U	1	60	1830753	2063740	18-2011	WPB,L	1
Alpha I SS	TODOS		18-2002	PS	2	60	1830753	2063740	18-2055	WPB,U	1
BRAVO I	B664190	SUP	18-2002	PS	2	60	1830753	2063740	18-2015	PS,O	1
I	1534570	1536617	18-2009	WPB	1	60	1830753	2063740	18-2011	PS,I	1
I	1534570	1684187	18-2009	SSB	1	80	2063741	2898029	18-2002	PS	2
I	1534570	1684187	18-2002	PS	2	80	2063741	2898029	18-2009	SSB	1
I	1534570	1684187	18-2013	WP	1	80	2063741	2898029	18-2055	WPB,U	1
I	1536618	1684187	18-2014	WPB	1	80	2063741	2898029	18-2011	WPB,L	1
I	1563354	1684187	18-2013	WPB	1	90	2898020	3225967	18-2009	SSB	1

ALOJAMIENTO ENGRANAJE (Cont.)

Modelo Cola	Desde. S/N	Hasta. S/N	Retén Aceíte	Desc.	Cant.	Modelo Cola	Desde. S/N	Hasta. S/N	Retén Aceíte	Desc.	Cant.
90	2898020	3225967	18-2002	PS	2	260	4898730	6225576	18-2013	WPB,U	1
90	2898020	3225967	18-2011	WPB,L	1	260	4898730	6225576	18-2014	WPB,L	1
90	2898020	3225967	18-2055	WPB,U	1	280-TRS	4203750	4895399	18-2002	PS	2
120/140	2062141	6225576	18-2013	WPB,U	1	470	4208730	6225576	18-2009	SSB	1
120/140	2062141	4893634	18-2013	WP	1	470	4208730	6225576	18-2014	WPB,L	1
120/140	2062141	6225576	18-2014	WPB,L	1	470	4208730	6225576	18-2002	PS	2
120/140	2062141	6225576	18-2009	SSB	1	470	4208730	6225576	18-2013	WPB,U	1
120/140	2062141	6225576	18-2002	PS	2	485	4893835	SUP	18-2002	PS	2
160/165	2065190	SUP	18-2009	SSB	1	485	4893835	SUP	18-2009	SSB	1
160/165	2065190	SUP	18-2014	WPB,L	1	485	4893835	SUP	18-2013	WPB,U	1
160/165	2065190	SUP	18-2002	PS	2	485	4893835	SUP	18-2014	WPB,L	1
160/165	2065190	4890459	18-2013	WP	1	888	3106717	SUP	18-2014	WPB,L	1
160/165	2065190	SUP	18-2013	WPB,U	1	888	3106717	SUP	18-2009	SSB	1
225-S	3856268	4200499	18-2013	WPB,U	1	888	3106717	SUP	18-2013	WP	1
225-S	3856268	4200499	18-2014	WPB,L	1	888	3106717	SUP	18-2013	WPB,U	1
225-S	3856268	4200499	18-2002	PS	2	888	3106717	SUP	18-2002	PS	2
225-S	3856268	4200499	18-2009	SSB	1	898/228	4782330	6225576	18-2014	WPB,L	1
233	4200500	SUP	18-2009	SSB	1	898/228	4782330	6225576	18-2013	WPB,U	1
233	4200500	SUP	18-2013	WPB,U	1	898/228	4782330	6225576	18-2009	SSB	1
233	4200500	SUP	18-2002	PS	2	898/228	4782330	6225576	18-2002	PS	2
233	4200500	SUP	18-2014	WPB,L	1						
250	4791300	4898729	18-2013	WPB,U	1	PS	Retén eje hélice				
250	4791300	4898729	18-2014	WPB,L	1	PS,I	Eje hélice, retén interior				
250	4791300	4898729	18-2002	PS	2	PS,O	Eje hélice, retén exterior				
250	4791300	4898729	18-2009	SSB	1	SSB	Retén eje cambio				
255-TRS	3377316	4203749	18-2002	PS	2	WPB	Retén base bomba agua				
260	4898730	6225576	18-2009	SSB	1	WPB,L	Retén inf., base bomba agua				
260	4898730	6225576	18-2002	PS	2	WPB,U	Retén superior, base bomba agua				
						WP	Retén cuerpo bomba agua				

ARO TÓRICO

Ref #	O.E. #	Dimensiones	
		D. I.	Ancho (pulgadas)
18-7161	25-32546	3.250	.070
18-7162	25-33145	2.025	.135
18-7163	25-33465	2.415	.100
18-7164	25-33466	1.375	.100
18-7165	25-32509	.500	.065
18-7166	25-45254	.615	.065
18-7167	25-861844	3.609	.139
18-7168	25-48171	.370	.065
18-7169	25-70937	3.500	.135
18-7170	25-33504	1.365	.135
18-7171	25-30529	1.920	.100
18-7172	25-31305	3.250	.135
18-7173	25-30224Q	1.875	.135
18-7174	25-45711	.620	.100
18-7175	25-62817	3.750	.270
18-7176	25-896523	2.160	.100
18-7177	25-53421	2.625	.065
18-7180	25-26802	.445	.090
18-7188	25-805726	.361	.0635
18-7198	25-45710	1.430	.100
18-7411	25-35480	1.250	.100
18-7413	25-62702	.301	.070
18-7414	25-823683	1.989	.070
18-7415	25-64966	3.739	.070
18-7419	25-69202	2.675	.103
18-7420	25-25439	.862	.139
18-7421	25-16524	.150	.065
18-7426	25-30271	.740	.310
18-7440-1	25-36318	.799	.103
18-7445	25-55801	.801	.070
18-7449	25-97387	4.487	.103
18-7459	25-20826	2.234	.139
18-7464	25-39695	4.234	.139
18-7467	25-54030	2.987	.103
18-7474	25-94288	1.239	.070
18-7961	25-861844	3.650	.135

ALOJAMIENTO EJE

Modelo Cola	Desde. S/N	Hasta. S/N	Retén aceite	Desc.	Cant.	Modelo Cola	Desde. S/N	Hasta. S/N	Retén aceite	Desc.	Cant.
R/MR/Alpha I	6225577	SUP	18-7153	UJ	2	233	4200500	UP	18-7169	BC	1
R/MR/Alpha I	6225577	SUP	18-7169	BC	1	250	4791300	4898729	18-7153	UJ	2
R/MR/Alpha I	6225577	SUP	18-7161	TC	1	250	4791300	4898729	18-7169	BC	1
Alpha I SS	TODOS		18-7161	TC	1	250	4791300	4898729	18-7161	TC	1
Alpha I SS	TODOS		18-7169	BC	1	255-TRS	3377316	4203749	18-7175	DSH	1
Alpha I SS	TODOS		18-7153	UJ	2	260	4898730	6225576	18-7169	DG	1
BRAVO (I/II)	B664190	SUP	18-7198	DSH	1	260	4898730	6225576	18-7161	TC	1
BRAVO (I/II)	B664190	SUP	18-7153	UJ	2	260	4898730	6225576	18-7170	BH	1
I	1534570	1684187	18-7127	DG	1	260	4898730	6225576	18-7153	UJ	2
I,IA,IB,IC	1534570	1777798	18-7165	USSL	1	280-TRS	4203750	4895399	18-7175	DSH	1
I,IA,IB,IC	1535212	2065189	18-7170	BH	2	470	4208730	6225576	18-7169	BC	1
IA,IB,IC	1684188	2065189	18-7153	UJ	2	470	4208730	6225576	18-7161	TC	1
IA,IB,IC	1684188	2065189	18-7169	BC	1	470	4208730	6225576	18-7153	UJ	2
II	2398798	2671321	18-7153	UJ	2	470	4893835	6225576	18-7170	BH	1
II SSM	TODOS		18-7175	DSH	1	485	4893835	SUP	18-7161	TC	1
II SSM	TODOS		18-7153	UJ	2	485	4893835	SUP	18-7170	BH	1
II TR	3377316	4794899	18-7175	DSH	1	485	4893835	SUP	18-7153	UJ	2
III/III SSM	TODOS		18-7115	FC	1	485	4893835	SUP	18-7169	DG	1
IV SSM ①	TODOS		18-7115	FC	1	888	3106717	SUP	18-7161	TC	1
I/IA/IB/IC	1534570	2065189	18-7161	TC	1	888	3106717	SUP	18-7169	BC	1
TR/TRS ③	4794900	SUP	18-7153	UJ	2	888	3106717	SUP	18-7153	UJ	2
TR/TRS	4794900	SUP	18-7175	DSH	1	898/228	4782330	6225576	18-7169	BC	1
120/140	2062141	6225576	18-7161	TC	1	898/228	4782330	6225576	18-7161	TC	1
120/140	2062141	6225576	18-7170	BH	1	898/228	4782330	6225576	18-7153	UJ	2
120/140	2062141	6225576	18-7169	DG	1	898/228	4898730	6225576	18-7170	BH	1
120/140	2062141	6225576	18-7153	UJ	2						
160/165	2065190	SUP	18-7170	BH	1						
160/165	2065190	SUP	18-7169	DG	1						
160/165	2065190	SUP	18-7153	UJ	2						
160/165	2065190	SUP	18-7161	TC	1						
215H	2782203	2909034	18-7153	UJ	2						
215H	2782203	2909034	18-7146	PC	1						
215E ②	2909035	2915034	18-7174	FC	1						
215E	2909035	2915034	18-7146	CC	1						
225-S	3856268	4200499	18-7153	UJ	2						
225-S	3856268	4200499	18-7169	BC	1						
225-S	3856268	4200499	18-7161	TC	1						
233	4200500	SUP	18-7161	TC	1						
233	4200500	SUP	18-7153	UJ	2						

① Diseño 1 ST
 ② 5/8" ID
 ③ Con transmisión Borg Warner
 BC Retén Cojinete
 BH Retén alojamiento correa
 CC Retén tapa transmisión
 DG Retén engranaje
 DSH Retén alojamiento transmisión
 FC Retén tapa frontal
 PC Retén tapa bujía
 TC Retén tapa alta
 USSL Retén eje gas
 UJ Retén cruceta

ALOJAMIENTO ENGRANAJES

Modelo cola	Desde. S/N	Hasta. S/N	Retén Aceite	Desc.	Cant.	Modelo Cola	Desde. S/N	Hasta. S/N	Retén Aceite	Desc.	Cant.
R/MR/Alpha I	6225577	SUP	18-7162	WPB	1	90	2898020	3225967	18-7155	WOAL	1
MR/Alpha I	6225577	SUP	18-7176	WPB	1 ②	120/140	2062141	6225576	18-7153	SSB	1
R/MR/Alpha I	6225577	SUP	18-7158	UDS	1	120/140	2062141	6225576	18-7158	UDS	1
R/MR/Alpha I	6225577	SUP	18-7159	PBH	1	120/140	2062141	6225576	18-7159	PBH	1
R/MR/Alpha I	6225577	SUP	18-7153	SSB	1	120/140	2062141	6225576	18-7162	WPB	1
Alpha I SS	TODOS		18-7159	PBH	1	120/140	4893635	6225576	18-7114	GH	1 ③
Alpha I SS	TODOS		18-7158	UDS	1	160/165	2065190	SUP	18-7162	WPB	1
Alpha I SS	TODOS		18-7153	SSB	1	160/165	2065190	SUP	18-7153	SSB	1
Alpha I SS	TODOS		18-7176	WPB	1 ②	160/165	2065190	SUP	18-7158	UDS	1
BRAVO I	B664190	SUP	18-7159	PBH	1	160/165	2065190	SUP	18-7159	PBH	1
BRAVO I/II	B664190	SUP	18-7163	GH	1	165	4890460	SUP	18-7114	GH	1 ③
I	1534570	1684187	18-7157	PBH	1	225-S	3856268	4200499	18-7153	SSB	1
I	1534570	1536617	18-7153	WPB	1	225-S	3856268	4200499	18-7162	WPB	1
I	1534570	1684187	18-7153	SSB	1	225-S	3856268	4200499	18-7158	UDS	1
I,IA,IB,IC	1534570	2065189	18-7158	UDS	1	225-S	3856268	4200499	18-7159	PBH	1
I,IA,IB,IC	1536618	2065189	18-7162	WPB	1	233	4200500	SUP	18-7162	WPB	1
IA,IB,IC	1684188	2065189	18-7159	PBH	1	233	4200500	SUP	18-7158	UDS	1
IA,IB,IC	1684188	1777798	18-7153	WPB	1	233	4200500	SUP	18-7159	PBH	1
IA,IB,IC	1684188	2065189	18-7153	SSB	1	233	4200500	SUP	18-7153	SSB	1
II	1474909	2671321	18-7159	PBH	1	250	4791300	4898729	18-7159	PBH	1
III	TODOS		18-7151	BRL	1	250	4791300	4898729	18-7158	UDS	1
III	TODOS		18-7174	BRS	1	250	4791300	4898729	18-7162	WPB	1
TRS	4794900	SUP	18-7159	PBH	1	250	4791300	4898729	18-7153	SSB	1
60	1830753	2063740	18-7153	SSB	1	255-TRS	3377316	4203749	18-7159	PBH	1
60	1830753	2063740	18-7160	PBH	1	260	4898730	6225576	18-7162	WPB	1
60	1830753	2063740	18-7155	WOAL	1	260	4898730	6225576	18-7159	PBH	1
60	1830753	2063740	18-7114	WOAS	1	260	4898730	6225576	18-7153	SSB	1
80	2063741	2898029	18-7157	PBH	1	260	4898730	6225576	18-7158	UDS	1
80	2063741	2898029	18-7155	WOAL	1	260	4898730	6225576	18-7114	GH	1 ③
80	2063741	2898029	18-7114	WOAS	1	280-TRS	4203750	4895399	18-7159	PBH	1
80	2063741	2898029	18-7153	SSB	1	470	4208730	6225576	18-7159	PBH	1
90	2898020	3225967	18-7114	WOAS	1	470	4208730	6225576	18-7162	WPB	1
90	2898020	3225967	18-7157	PBH	1	470	4208730	6225576	18-7158	UDS	1
90	2898020	3225967	18-7153	SSB	1	470	4208730	6225576	18-7153	SSB	1

Aros tóricos
MERCURISER

ALOJAMIENTO ENGRANAJE (Cont.)

Modelo Cola	Desde. S/N	Hasta. S/N	Retén aceite	Desc.	Cant.	Modelo cola	Desde. S/N	Hasta. S/N	Retén aceite	Desc.	Cant.
470	4893835	6225576	18-7114	GH	1	③	V-8 Solo motores				
485	4893835	SUP	18-7158	UDS	1	BRL	Retén grande cojinete				
485	4893835	SUP	18-7162	WPB	1	BRS	Retén pequeño cojinete				
485	4893835	SUP	18-7153	SSB	1	GH	Retén alojamiento engranaje				
485	4893835	SUP	18-7114	GH	1	PGH	Retén cojinete hélice				
485	4893835	SUP	18-7159	PBH	1	SSB	Casquillo eje hélice				
888	3106717	SUP	18-7162	WPB	1	UDS	Retén superior transmisión				
888	3106717	SUP	18-7158	UDS	1	WOAL	Retén grande adaptador agua y aceite				
888	3106717	SUP	18-7153	SSB	1	WOAS	Retén pequeño adaptador agua y aceite				
888	3106717	SUP	18-7159	PBH	1	WPB	Retén base bomba agua				
898/228	4782330	6225576	18-7158	UDS	1						
898/228	4782330	6225576	18-7153	SSB	1						
898/228	4782330	6225576	18-7159	PBH	1						
898/228	4782330	6225576	18-7162	WPB	1						
898/228	4898730	6225576	18-7114	GH	1						
①	2.019 DI										
②	2.17 DI										

ALOJAMIENTO TRANSOM

Modelo Cola	Desde. S/N	Hasta. S/N	Retén Aceite	Desc.	Cant.	Modelo Cola	Desde. S/N	Hasta. S/N	Retén Aceite	Desc.	cant.
R/MR/Alpha I	6225577	SUP	18-7170	BH	1	470	4208730	6225576	18-7152	EE	1
BRAVO (I/II)	B664190	SUP	18-7168	V	2	470	4208730	4893934	18-7170	BH	1
I	1534570	1641940	18-7165	GHB	2	485	4893835	SUP	18-7152	EE	1
II	1474909	1475005	18-7151	SL	1	888	3106717	SUP	18-7170	BH	1
II	1602186	2671321	18-7162	GHAS	1	888	3106717	SUP	18-7114	GH	1
II	1732380	2671321	18-7172	GHAL	1	888	3106717	SUP	18-7152	EE	1
III/III SSM/IV		TODOS	18-7159	BH	1	898/228	4782330	4898729	18-7170	BH	1
60	1830753	2063740	18-7172	BH	1	898/228	4782330	4898729	18-7114	GH	1
80	2063741	2898029	18-7172	BH	1	898/228	4782330	6225576	18-7152	EE	1
90	2898020	3225967	18-7172	BH	1						
120/140	2062141	6225576	18-7152	EE	1	①	Con depósito de aceite				
160/165	2065190	SUP	18-7152	EE	1	BH	Retén alojamiento correo				
225-S	3856268	4200499	18-7170	BH	1	EE	Retén codo escape				
225-S	3856268	4200499	18-7152	EE	1	GH	Retén aloj. fuelle transom				
225-S	3856268	4200499	18-7114	GH	1	GHAL	Retén adaptador fuelle transom				
233	4200500	SUP	18-7152	EE	1	GHAS	Retén pequeño adaptador fuelle transom				
233	4200500	SUP	18-7114	GH	1	GHB	Retén tornillo				
233	4200500	SUP	18-7170	BH	1	SL	Retén dirección				
250	4791300	4898729	18-7152	EE	1	V	Retén válvula				
250	4791300	4898729	18-7114	GH	1						
250	4791300	4898729	18-7170	BH	1						
260	4898730	6225576	18-7152	EE	1						

BOMBA HIDRÁULICA

Modelo cola	Desde. S/N	Hasta. S/N	Retén aceite	Desc.	Cant.	Modelo Cola	Desde. S/N	Hasta. S/N	Retén aceite	Desc.	Cant.
R/MR/Alpha I	6225577	SUP	18-7168	CV	4	255-TRS	3377316	4203749	18-7168	CV	4
BRAVO (I/II)	B664190	SUP	18-7134	ORC	1	260	4898730	6225576	18-7168	CV	4
BRAVO (I/II)	B664190	SUP	18-7158	ORS	1	280-TRS	4203750	4895399	18-7168	CV	4
II	2398798	2671321	18-7168	CV	4	470	4208730	6225576	18-7168	CV	4
II TR	3377316	4794899	18-7168	CV	4	485	4893835	SUP	18-7168	CV	4
III/III SSM/IV		TODOS	18-7168	CV	4	888	3106717	SUP	18-7168	CV	4
TR/TRS	4794900	SUP	18-7168	CV	4	898/228	4898730	6225576	18-7168	CV	4
90	2898020	3225967	18-7168	CV	4						
120/140	2062141	6225576	18-7168	CV	4	CV	Válvula control				
160/165	2065190	SUP	18-7168	CV	4	ORC	Conector depósito aceite				
215H/E	2782203	2915034	18-7168	CV	4	ORS	Interruptor depósito aceite				
225-S	3856268	4200499	18-7168	CV	4						
233	4200500	SUP	18-7168	CV	4						

VÁLVULA REVERSA

Modelo cola	Desde. S/N	Hasta. S/N	Retén aceite	Desc.	Cant.	Modelo cola	Desde. S/N	Hasta. S/N	Retén aceite	Desc.	Cant.
R/MR/Alpha I	6225577	SUP	18-7174	VC	1	260	4898730	6225576	18-7174	VC	1
R/MR/Alpha I	6225577	SUP	18-7198	V	1	470	4208730	6225576	18-7198	V	1
II	2398798	2671321	18-7198	V	1	470	4208730	6225576	18-7174	VC	1
II	2398798	2671321	18-7174	VC	1	485	4893835	SUP	18-7174	VC	1
120/140	2062141	6225576	18-7198	V	1	485	4893835	SUP	18-7198	V	1
120/140	2062141	6225576	18-7174	VC	1	898/228	4782330	6225576	18-7174	VC	1
160/165	2065190	SUP	18-7198	V	1	898/228	4782330	6225576	18-7198	V	1
160/165	2065190	SUP	18-7174	VC	1						
250	4791300	4898729	18-7198	V	1						
250	4791300	4898729	18-7174	VC	1	V	Válvula retén				
260	4898730	6225576	18-7198	V	1	VC	Retén tapa válvula				

DIESEL SISTEMA ELÉCTRICO



**18-6949
ARRANQUE**

Reemplaza:
Mercuriser 50-831001562,
50-831001961
Para: WO4CTA (150 HP) HINO 234 I/L4,
WO4CTI (210 HP) HINO 234 I/L4



**18-6957
ARRANQUE**

Reemplaza:
Mercuriser 50-801333980,
50-854178, 50-855507



**18-6947
ARRANQUE**

Reemplaza:
Mercuriser 50-805991
Para: 7.3L (BRAVO & MIE) DIESEL NAV
444 V-8 1994-1996



**18-6954
ARRANQUE**

Reemplaza:
Mercury 50-831001671, 672,
50-831002050, 051, 052
Para: EH700 (175/220HP) HINO 393 I/L6,
HINO Diesel (Ver Mercuriser)



**18-6870
ARRANQUE**

Reemplaza: Mercury 50-805833, T
Para: D7.3L D-tronic 260 LD, 300 año 1999



**18-6948
ALTERNADOR**

Reemplaza: Mercury 882571
Para: CMD 1.7 MI 120 I/L4, CMD 1.7 MS 120
I/L4, D1.7L DTI

MERCURISER ALTERNADOR/APLICACIONES ARRANQUE

Modelo	Año	Arranque	Modelo	Año	Arranque
530D-TA (Bravo & MIE)	1989-1993	18-6957	EI 165	2004-2005	18-6957
636D-TA (Bravo & MIE)	1989-1993	18-6957	EI 200	2004-2005	18-6957
6BTA5.9-M	1989-SUP	18-6947	EI 250	2004-2005	18-6957
7.3L (Bravo & MIE)	1994-1998	18-6947	EI 300	2004-2005	18-6957
D183 Turbo AC (Bravo & MIE)	1990-1993	18-6957	ES 165	2004-2005	18-6957
D2.8L D-Tronic (Bravo & MIE)	1997-1999	18-6957	ES 250	2004-2005	18-6957
D219 Turbo AC (Bravo & MIE)	1990-1993	18-6957	ES300	2004-2005	18-6957
D254 Turbo AC (Bravo & MIE)	1990-1993	18-6957	MI 200	2004-2005	18-6957
D3.0L Bravo	1994-1997	18-6957	MS 200	2004-2005	18-6957
D3.0L MIE	1994-1995	18-6957	WO4CTA HINO 234 (150HP)	1990-1997	18-6949
D3.6L (Bravo & MIE)	1994-1996	18-6957	WO4CTI HINO 234 (210HP)	1990-1997	18-6949
D3.6L W Bravo (Export)	1996-SUP	18-6957	WO6DTA HINO 351 (310HP)	1990-1997	18-6949
D4.2L (Bravo & MIE)	1994-1995	18-6957	WO6DTI HINO 351 (250HP)	1990-1997	18-6949
D4.2L/ 250 D-Tronic	1997-1999	18-6957			

DIESEL FILTRO COMBUSTIBLE



18-7873

Reemplaza:
Mercuriser 35-808275
Para modelos: D7.3/270 Bravo &
MIE Diesel (1994-96)

DIESEL FILTRO ACEITE

- Capa de epoxy de guan resistencia a la corrosión.
- Recipiente de acero extra-resistente.
- Elemento filtrante de alta eficiencia.
- Cubierta por la garantía Sierra.



18-7871

Reemplaza:
Mercuriser 35-805809

MERCURUISER 				MERCURUISER 			
POTENCIA HP	CIL	CHAMPION	REF. PRONAUTIC	POTENCIA HP	CIL	CHAMPION	REF. PRONAUTIC
110	4, 153 CID	RN5C	050951	280, 300 Tempest, 320 EFI	V8 283, 327, 305, 350 CID	RV15YC4	050928
110	4, 153 CID	RV15YC4	050928	350 Mag (Carb)	V8 283, 327, 305, 350 CID	RV9IMC	050973
140 HASTA 3826282	4, 181 CID	RN5C	050951	350 Mag EFI/MP HASTA 0F602199	V8 283, 327, 305, 350 CID	RV9IMC	050973
140 DESDE 3826283	4, 181 CID	RV15YC4	050928	350 Mag EFI GEN+ DESDE 0F800500	V8	RS12YC	050949
3.0 HASTA 0F353100	4, 181 CID	RV15YC4	050928	350 Mag MPI GEN+ DESDE 0F602000	V8	RS12YC	050949
3.0 DESDE 0L010042	4, 181 CID	RS12YC	050949	350 Mag MPI GEN+ DESDE 0L604000	V8	RS12PYP	050978
3.0 LX	4, 181 CID	RS12YC	050949	377 Scorpion DESDE 0L416146	V8 283, 327, 305, 350 CID	RS12YC	050949
470,165, 170, 485, 488, 180, 190	4, 224 CID	RS12YC	050949	5.0 L MPI	V8 283, 327, 305, 350 CID	RS12YC	050949
3.7L, 3.7LX	4, 224 CID	RS12YC	050949	5.0 L HASTA 0L000000	V8 283, 327, 305, 350 CID	RV9IMC	050973
140, 150, 160	4, 224 CID	RS12YC	050949	5.0 L GEN+ 0L015751	V8 283, 327, 305, 350 CID	RS12YC	050949
165 HASTA 2771483	6, 194, 230 & 292 CID	RN5C	050951	5.0 L EFI GEN+ 0L012052	V8 283, 327, 305, 350 CID	RS12YC	050949
165 DESDE 2771484	6, 194, 230 & 292 CID	RV15YC4	050928	5.0 LX	V8 283, 327, 305, 350 CID	RV9IMC	050973
200	6, 194, 230 & 292 CID	RN5C	050951	5.7 L HASTA 0L000000	V8 283, 327, 305, 350 CID	RV9IMC	050973
185	V6, 229 CID	RV15YC4	050928	5.7 L EFI HASTA 0L000000	V8 283, 327, 305, 350 CID	RV9IMC	050973
175,185,205	V6, 262 CID	RV15YC4	050928	5.7 L GEN+ DESDE 0L010037	V8 283, 327, 305, 350 CID	RS12YC	050949
262 MAG EFI GEN+ 0F80800-0L000000	V6, 262 CID	RS12YC	050949	5.7 L EFI GEN+ DESDE 0L010035	V8 283, 327, 305, 350 CID	RS12YC	050949
4.3L MPI	V6, 262 CID	RV15YC4	050928	5.7 LX, 5.7LX EFI	V8 283, 327, 305, 350 CID	RV9IMC	050973
4.3L HASTA 0F802999	V6, 262 CID	RV15YC4	050928	5.7 LX EFI GEN+	V8 283, 327, 305, 350 CID	RS12YC	050949
4.3LX DESDE 0F802999	V6, 262 CID	RV15YC4	050928	325 DESDE 3043030	V8 427, 454 & 482 CID	V63C	050946
4.3 GEN+ DESDE 0L010065	V6, 262 CID	RS12YC	050949	330, 330 (B-W), 370, 400, 400 Cyclone	V8 427, 454 & 482 CID	RV15YC4	050928
4.3LL EFI GEN+ DESDE 0L0120009	V6, 262 CID	RS12YC	050949	420, HP425, 440 Cyclone, HP450	V8 427, 454 & 482 CID	RV15YC4	050928
4.3LH GEN+DESDE 0L010044	V6, 262 CID	RS12YC	050949	454 Mag Alpha, Bravo, EFI/MP/MPI	V8 427, 454 & 482 CID	RV15YC4	050928
4.3LX GEN+ 0F803000-0L000000	V6, 262 CID	RS12YC	050949	460 Cyclone, 475 Turbo, HP525SC	V8 427, 454 & 482 CID	V63C	050946
4.3LXH GEN+ 0F803000+0L000000	V6, 262 CID	RS12YC	050949	7.4 L Alpha, 7.4 L Bravo	V8 427, 454 & 482 CID	RV15YC4	050928
888 DESDE 4169597 CULATAS 14 mm	FORD V8	RV15YC4	050928	7.4 L TR OB771113-OC407646	V8 427, 454 & 482 CID	RV15YC4	050928
233 CULATAS 14 mm HEADS	FORD V8	RV15YC4	050928	7.4 L MPI (L29) DESDE 0L010003	V8 427, 454 & 482 CID	RS12YC	050949
255 DESDE 4175499 CULATAS 14 mm	FORD V8	RV15YC4	050928	7.4 LX EFI, 7.4 LX MPI	V8 427, 454 & 482 CID	RV15YC4	050928
190	V8 283, 327, 305, 350 CID	RJ12YC	050980	HP465, HP500 (502 CID), HP500 EFI	V8 502, 540 & 572 CID	RV15YC4	050928
898, 200	V8 283, 327, 305, 350 CID	RV9IMC	050973	HP500 Bulldog 540, HP525 SC 454	V8 502, 540 & 572 CID	V63C	050946
225 DESDE 2278647	V8 283, 327, 305, 350 CID	RJ12YC	050980	HP575, HP600SC Bob-tail (502 CID)	V8 502, 540 & 572 CID	V63C	050946
228, 230	V8 283, 327, 305, 350 CID	RV9IMC	050973	HP800SC (572 CID)	V8 502, 540 & 572 CID	V63C	050946
250 DESDE 4768000	V8 283, 327, 305, 350 CID	RV15YC4	050928	502 MAG (CARB.), EFI/MA/MPI	V8 502, 540 & 572 CID	RV15YC4	050928
255	V8 283, 327, 305, 350 CID	RV15YC4	050928	600SC, 800SC	V8 502, 540 & 572 CID	V63C	050946
260	V8 283, 327, 305, 350 CID	RV9IMC	050973				

MERCUISER



MERCUISER



POTENCIA HP	CIL	NGK	REF. PRONAUTIC	POTENCIA HP	CIL	NGK	REF. PRONAUTIC
120 hasta TO3825578	4	BR6ES	050705	5.7 MPI MIE	8	ITR4A15	050601
140 hasta TO3825578	4	BR6ES	050705	5.7 Black Scorpion OM391852+	8	TR55	050877
2.5L 153,CID	4	BR6EF	050706	5.7 Black Scorpion OM391778+	8	TR55	050877
3.0L 181 CID desde OL010042	4	BPR6EFS	050857	350MAGEFIGEM+desde OF800500	8	BPR6EFS	050857
3.0L 181 CID hasta OF3355100	4	BR6ES	050705	350MAGEFI/MP desde OF602199	8	BR6FS	050831
3.0LX	4	BPR6EFS	050857	350MAGMPIGEN+ desde OF602000 al OM320489	8	BR6FS	050831
165 224 CID, 170 224 CID	4	BR6FS	050831	350MAGMPIGEN+ desde OM320590	8	TR55	050877
180 224 CID, 190 224 CID	4	BR6FS	050831	350MAGMPIGEN+Horizon del OL304700 al OM309999	8	TR5	050708
3.7L 224CID, 3,7LX224 CID	4	BR6FS	050831	350MAGMPIGEN+Horizon desde OM310000	8	TR55	050877
470 224CID, 485 224CID, 488 224CID	4	BR6FS	050831	350MAGMPI Alpha/Bravo	8	ITR4A15	050601
140, 150, 160	6	BR6ES	050705	350MAG MPI Horizon Alpha/Bravo	8	ITR4A15	050601
165 hasta TO2771483	6	BR6ES	050705	377 Magnum MPI Bravo	8	ITR4A15	050601
200, 175, 185, 205, 185 229 CID	6	BR6FS	050831	898.200	8	YR5	050709
262MAG EFI GEN+ delOF803800 al OL00000	6	BPR6EFS	050857	6.2 MPI MIE	8	ITR4A15	050601
4.3L hasta OF802999	6	BR6ES	050705	6.2 mpi Horizon MIE	8	ITR4A15	050601
4.3L EFI GEN+ desde OL012009	6	BPR6EFS	050857	MX62MPI hasta OM320613	8	BPR6EFS	050857
4.3L GEN+ desde OL010065	6	BPR6EFS	050857	MX6.2L MPI desde OM320614	8	TR55	050877
4.3 LH EFI GEN+ desde OL010044	6	BPR6EFS	050857	MX6.2 MPI Horizon desde OM320614	8	TR55	050877
4.3L MPI GEN+ desde OM322781	6	TR55	050877	Scorpion desde OL416146	8	BPR6EFS	050857
4.3LX hasta OF802999	6	BR6ES	050705	233	8	BPR6EFS	050857
4.3LX GEN+ desde OF803000 hasta OL00000	6	BPR6EFS	050857	255 hasta 4175498	8	BR6FS	050831
4.3LXH GEN+ desde OF803000 hasta OL00000	6	BPR6EFS	050857	255 desde 4175499	8	BPR6EFS	050857
250 desde 4768000 - 255 - 260	8	BR6FS	050831	888 desde 4169597	8	BPR6EFS	050857
280, 300 Tempest, 320 EFI, 350 MAG	8	BR6FS	050831	330	8	BR6ES	050705
5.0L hasta OL00000	8	TR5	050708	390	8	BR6ES	050705
5.0L EFI GEN+ desde OL015751	8	BPR6EFS	050857	420, 440 Ciclone, 454MAGALPHA	8	BR6FS	050831
5.0L MPI GEN+ desde OM320415	8	TR55	050877	454 Magnum Bravo, 454MAFEFHMPI	8	BR6FS	050831
5.0L MPI Alpha/Bravo	8	ITR4A15	050601	502MAG, 502MAGEFHMP,MPI	8	BR6FS	050831
5.0 LX	8	YR5	050709	7.4L ALPHA, 7.4L Bravo	8	BR6FS	050831
5.0 L MPI2002+	8	BPR6EFS	050857	7.4LMPI (L29)	8	BPR6EFS	050857
5.7l, 5.7LEFI hasta OL000000	8	BR6FS	050831	7.4LXEFI Bravo, MPIBravo	8	BR6FS	050831
5,7L EFIGEN+ desde OL010035	8	BPR6EFS	050857	7.4TR desde OB771113 hasta OC407646	8	BR6FS	050831
5.7L GEN+ desde OL010037	8	BPR6EFS	050857	HP425mHP450,HP465,HP500,502CID	8	BR6FS	050831
5.7LX, 5.7LX EFI	8	BR6FS	050831	8.1L, 8.1 SHO, 8.1 S Horizon (2000-2006)	8	TR55	050877
5.7LX EFI GEN+	8	BPR6EFS	050857	8.1 SHO, 8.1 S Horizon (2007 +)	8	IZFR7M	050602
5.7MPI Horizon MIE	8	ITR4A15	050601				

Bujías
MERCUISER



HÉLICES BAEKSAN

- Baeksan fabrica miles de hélices desde el año 1984. Nuestras helices de altas prestaciones fabricadas con los mejores materiales aseguran una larga vida y una navegación tranquila y sin sobresaltos.
- Sus palas compensadas ofrecen una reducción significativa de la vibraciones.
- Cojinete de goma insertado en el nucleo en versión fija o nucleo intercambiable.
- Mano de pintura de alto grosor para evitar la corrosión.

**En caso de no conocer la referencia original de la hélice a reemplazar siga los siguientes pasos:
Comprueba el rango de Revoluciones por minuto (RPM) del fabricante del motor en el manual.**

1. Comprueba las RPM maximas del motor leyendo el panel para determinar el paso y velocidad optimo.
2. Si las RPM maximas exceden el rango recomendado, disminuye las RPM utilizando un paso superior.
3. Si las RPM son mas bajas que el rango recomendado, aumenta las RPM utilizando un paso inferior.

Si no localiza la hélice que necesita contacte con nuestro departamento técnico.

Tipo	Modelo Intraborda	Referencia-Diam./Paso	Ref. Original	Pala	Núcleo
E	 <p>4-3/4" Caja de engranajes Para Colas Mercruiser Alpha One Sterndrives Bravo One Sterndrives</p> <p>Escape a través del núcleo 15 estrías</p>	62U1501613 16x13	48-78114A45	3	Interc. 62BHME
		62U150151415 15 1/4x15	48-78116A45	3	
		62U1501616 16x16	48-16440A45	3	
		62U1351517 15x17	48-832828A45	3	
		62U150141219 14 1/2x19	48-832830A45	3	
		62U150141421 14 1/4x21	48-832832A45	3	
		62U1501423 14x23	48-832834A45	3	
		624U1501516 15x16	48-834850A45	4	
		624U150141218 14 1/2x18	48-834852A45	4	
624U1501420 14x20	48-834854A45	4			
F	 <p>Para colas Bravo Two</p> <p>Escape a través del núcleo, 19 estrías</p>	62M300183417 18 3/4x17 LH	48-18613A40	3	Fijo
		62M300183417 18 3/4x17 RH	48-18612A40	3	
		62M300181419 18 1/4x19 LH	48-18615A40	3	
		62M300181419 18 1/4x19 RH	48-18614A40	3	
		62M300173421 17 3/4x21 LH	48-18617A40	3	
		62M300173421 17 3/4x21 RH	48-18616A40	3	
		62M300171223 17 1/2x23 LH	48-18619A40	3	
		62M300171223 17 1/2x23 RH	48-18618A40	3	

QNN QUICK NAUTICAL NETWORK



No se preocupe, a bordo tiene un Quick

Desde hace más de 30 años, los productos Quick son Made in Italy por la excelencia en el sector de los accesorios náuticos y sinónimo de fiabilidad para armadores y embarcaciones en todo el mundo.

QNN Quick Nautical Network
es un dispositivo innovador, que permite la integración de sistemas Quick con los sistemas de navegación.

| QUICK NAUTICAL EQUIPMENT | MC² QUICK GYRO | QNN - QUICK NAUTICAL NETWORK | QUICK MARINE LIGHTING |

① 18-5001D Display Package



**18-5001
KIT ENCENDIDO**
Reemplaza: 172525

— CONTIENE —

Ref #	O.E. #	Descripción
18-5157	580290	Juego de contacto
18-5200	580256	Condensador

Display Package



**18-5250
KIT ENCENDIDO**
Reemplaza: 172527

— CONTIENE —

Ref #	O.E. #	Descripción
18-5311	380538	Juego de contacto
18-5345	380537	Condensador
18-5418	384735	Rotor

Delco 4 & 6 cil.

Display Package



**18-5251
KIT ENCENDIDO**
Reemplaza: 173619

— CONTIENE —

Ref #	O.E. #	Descripción
18-5314	382135	Juego de contacto
18-5338	382136	Condensador
18-5404-1	982211	Rotor
18-5376		Tapa alta



**18-5256
KIT ENCENDIDO**
Reemplaza: 172531

— CONTIENE —

Ref #	O.E. #	Descripción
18-5314	382135	Juego de contacto
18-5338	382136	Condensador
18-5411	982342	Rotor

Mallory 8 cil. Tapa plana

① 18-5258D Display Package



**18-5258
KIT ENCENDIDO**
Reemplaza: 173690, 987925

— CONTIENE —

Ref #	O.E. #	Descripción
18-5303	980893	Juego contacto
18-5347	980894	Condensador
18-5407	980892	Rotor

Prestolite 8 cil.

Display Package



**18-5260
KIT ENCENDIDO**
Reemplaza: 173829, 987926

— CONTIENE —

Ref #	O.E. #	Descripción
18-5303	980893	Juego de contacto
18-5347	980894	Condensador
18-5403	982880	Rotor



**18-5252
KIT ENCENDIDO**
Contiene:

Ref.	Descripción
18-5310	Juego contactos
18-5344	Condensador
	Rotor

Delco 8 cil.



**18-5266
KIT ENCENDIDO**
Para: Distribuidor Flame Thrower 18-5481,
18-5482, 18-5483, 18-5477, 18-5478 y 18-5479

Display Package



**18-5268
KIT ENCENDIDO**

— CONTIENE —

Ref #	O.E. #	Descripción
18-5311	380538	Juego contacto
18-5345	380537	Condensador
18-5418	384735	Rotor
18-5385	380541	Tapa distribuidor

Delco En línea 4 - Punto único

Display Package



**18-5269
KIT ENCENDIDO**

— CONTIENE —

Ref #	O.E. #	Descripción
18-5311	380538	Juego contacto
18-5345	380537	Condensador
18-5418	384735	Rotor
18-5386	980152	Tapa distribuidor

Delco En línea 6 - punto único

Display Package



**18-5271
KIT ENCENDIDO**

— CONTIENE —

Ref #	O.E. #	Descripción
18-5314	382135	Juego contacto
18-5338	382136	Condensador
18-5404-1	982211	Rotor
18-5376	982209	Tapa distribuidor

Mallory V-8 - Punto único - Top Terminal

Display Package



**18-5272
KIT ENCENDIDO**

— CONTIENE —

Ref #	O.E. #	Descripción
18-5314	382135	Juego contacto
18-5338	382136	Condensador
18-5411	982342	Rotor
18-5375	382133	Tapa distribuidor

Mallory Flat V-8 - Punto único - Terminal lateral - Tapa plana

Display Package



**18-5275
KIT ENCENDIDO**

— CONTIENE —

Ref #	O.E. #	Descripción
18-5303	980893, 987136, 987894	Juego contacto
18-5347	980894, 987895	Condensador
18-5403	982880	Rotor
18-5352	984401	tapa distribuidor

Prestolite V-8 - Punto único - Tapa con tornillo

APLICACIONES EMPIEZAN EN LA PÁGINA 210

① Referencias acabadas en "D" envasadas - Referencias normales no envasadas



**18-5276
KIT ENCENDIDO**
—CONTIENE—
Ref # O.E. # Descripción
18-5303 980893, 987136, juego cont.
987894
18-5347 980894, 987895 Condensador
18-5403 982880 Rotor
18-5353 984398 Tapa distribuidor
Prestolite V-6 - Punto único - Tapa con
tornillos



**18-5277
KIT ENCENDIDO**
—CONTIENE—
Ref # O.E. # Descripción
18-5303 980893,
987136, 987894 Juego cont.
18-5347 980894, 987895 Condensador
18-5407 980892 Rotor
18-5369 982336 Tapa distribuidor
Prestolite V-8 - Punto único - Cierre clip



**18-5278
KIT ENCENDIDO**
Para: Delco EST V-6



**18-5279
KIT ENCENDIDO**
Para: Prestolite Electronic V-8
—CONTIENE—
Ref # Descripción O.E.#Cant.
18-5352 Tapa distribuidor 392-97661
18-5403 Rotor 392-9089 1



**18-5280
KIT ENCENDIDO**
Para: Delco EST En-Linea 4
—CONTIENE—
Ref # Descripción O.E.# Cant.
18-5361 tapa 986643 1
18-5406 Rotor, Delco 986651 1



**18-5281
KIT ENCENDIDO**
Para: Delco EST • V-8



**18-5283
KIT ENCENDIDO**
Para: Mallory punto unico
En-Linea 4
—CONTIENE—
Part # Descripción
18-5397 Tapa distribuidor
18-5404-1 Rotor
18-5314 Juego contacto
18-5338 Condensador



**18-5157
JUEGO CONTACTO**
Reemplaza: 580290



**18-5303
JUEGO CONTACTO**
Reemplaza: 980893,
987136, 987894



**18-5311
JUEGO CONTACTO**
Reemplaza: 380538



**18-5314
JUEGO CONTACTO**
Reemplaza: 382135



**18-5200
CONDENSADOR**
Reemplaza: 580256



**18-5338
CONDENSADOR**
Reemplaza: 382136



**18-5344
CONDENSADOR**
Reemplaza: 382125



**18-5345
CONDENSADOR**
Reemplaza: 380537



**18-5347
CONDENSADOR**
Reemplaza: 980894,
987895



**18-5403
ROTOR**
Reemplaza: 982880



**18-5404-1
ROTOR**
Reemplaza: 982211



**18-5405
ROTOR**
Reemplaza: 3854549
V-8
Para nuevos modelos GM
"Modulo sin Tapa"



**18-5406
ROTOR**
Reemplaza: 986651
Usar con 18-5361
Tapa distribuidor



**18-5407
ROTOR**
Reemplaza: 980892



**18-5408
ROTOR**
Reemplaza: 3854311
V-6
Para nuevos modelos GM
"Modulo en Tapa"

 <p>18-5411 ROTOR Reemplaza: 982342</p>	 <p>18-5413 ROTOR Reemplaza: 987986</p>	 <p>18-5418 ROTOR Reemplaza: 384735</p>	 <p>18-5419 ROTOR Reemplaza: 380542</p>	 <p>18-5301 KIT ENCENDIDO Reemplaza: Para: tapa macho distribuidor v-8</p>
 <p>18-5302 KIT ENCENDIDO Reemplaza: Para: tapa macho distribuidor v-8</p>	 <p>18-5473 TAPA DISTRIBUIDOR Tapa distribuidor negra con terminales hembra para distribuidores</p>	 <p>18-5474 TAPA DISTRIBUIDOR Tapa distribuidor roja con terminales hembra para distribuidores</p>	 <p>18-5248 TAPA DISTRIBUIDOR OMC 3854217 Para: OMC 5.0L(1994-96), 5.8L(1994-96)</p>	
 <p>18-5352 TAPA DISTRIBUIDOR Reemplaza: 984401 Prestolite</p>	 <p>18-5353 TAPA DISTRIBUIDOR Reemplaza: 984398 Prestolite</p>	 <p>18-5354 TAPA DISTRIBUIDOR Reemplaza: 3854548 V-8 Para nuevo modelo GM"modulo en tapa"</p>	 <p>18-5361 TAPA DISTRIBUIDOR Reemplaza: 986643</p>	 <p>18-5362 TAPA DISTRIBUIDOR Reemplaza: 3854331 V-6 Para nuevo modelo GM"Modulo en tapa"</p>
 <p>18-5369 TAPA DISTRIBUIDOR Reemplaza: 982336 con junta 18-5399</p>	 <p>18-5375 TAPA DISTRIBUIDOR Reemplaza: 382133</p>	 <p>18-5376 TAPA DISTRIBUIDOR Reemplaza: 982209 Mallory</p>	 <p>18-5384 TAPA DISTRIBUIDOR Reemplaza: 383587</p>	 <p>18-5385 TAPA DISTRIBUIDOR Reemplaza: 380541</p>
 <p>18-5386 TAPA DISTRIBUIDOR Reemplaza: 980152</p>	 <p>18-5397 TAPA DISTRIBUIDOR Reemplaza: 985218 Mallory 9-29418 Para: Ford 2.3L con Distribuidor Mallory (87-90)</p>	 <p>18-5107-1 MODULO DE ENCENDIDO Reemplaza: 3854003 4/6/8 cil</p>	 <p>18-5108 SENSOR (Pick-Up bobina) Reemplaza: 3854001, 986642 4, V-6 y V-8 cil.</p>	



18-26810
GM HEI 4 TERMINAL
PIGTAIL
Para: GM HEI Distributores con 4 terminales



18-26811
GM HEI 2 TERMINAL
PIGTAIL
Para: GM HEI Distribuidor con 2 terminales



18-26812
CONECTOR BO-
BINA GRIS



18-26813
CONECTOR BOBINA
NEGRO



18-29322
KIT TAPA & ROTOR
Para: Ford HEI Distribuidor

CARACTERÍSTICAS



- ★ *Relleno con aceite para mejor refrigeración y gran durabilidad*
- ★ *Baja resistencia que produce una gran intensidad para un mejor encendido y economía de combustible*
- ★ *Más hilos maximizan la energía y la fiabilidad sobre el rango de las RPM*
- ★ *Se ajusta a los soportes existentes para una fácil instalación*



18-5466
BOBINA DE ENCENDIDO
ALTO RENDIMIENTO
1.5 ohm (Aceite), negro - 8 cilindros: Flame-Thrower 40,000 voltios.
★ Usar con el kit de encendido de conversión electrónica original
★ Puede ser usado con otros sistemas de encendido



18-5469
BOBINA DE ENCENDIDO
DE ALTO RENDIMIENTO
3.0 ohm (Aceite), negro - 4 & 6 cilindros: Flame-Thrower 40,000 voltios.
★ Usar con kit de conversión de electrónica original
★ Puede ser usado con otros sistemas de Encendido



18-5472
BOBINA DE ENCENDIDO
DE ALTO RENDIMIENTO
0.6 ohm (filtro aceite), negro - 4, 6, & 8 cilindros: Flame-Thrower 45,000 voltios.
★ Bobina de baja de resistencia 0.6 ohm diseñada para usar con kits de conversión electrónica de alto rendimiento Ignitor II
★ Compatible con sistemas de platino y condensador

Ref #	Descripción	Bobina recomendada	Resistencia Ohms	Ref #	Descripción	Bobina Recomendada	Resistencia Ohms
18-5293-1	Kit de conversión electrónica	18-5469	3.0	18-5288	Kit conversión electrónica alto rendimiento	18-5472	0.6
18-5294	Kit de conversión electrónica	18-5469	3.0	18-5289	Kit conversión electrónica alto rendimiento	18-5472	0.6
18-5295	Kit de conversión electrónica	18-5469	3.0	18-5290	Kit conversión electrónica alto rendimiento	18-5472	0.6
18-5296-2	Kit de conversión electrónica	18-5466	1.5	18-5481	Distribuidor Flame-Thrower	18-5472	0.6
18-5298	Kit de conversión electrónica	18-5466	1.5	18-5482	Distribuidor Flame-Thrower	18-5472	0.6
18-5299	Kit de conversión electrónica	18-5466	1.5	18-5483	Distribuidor Flame-Thrower	18-5472	0.6
18-5286	Kit de conversión electrónica alto rendimiento	18-5472	0.6				



18-5433
BOBINA ENCENDIDO
Reemplaza: 915735
Utiliza una resistencia externa
Para: 3.0L (1991 & sup), 5.7 EFI (1996 & sup) y 7.4L EFI (1995 & sup)



18-5437
BOBINA ENCENDIDO
Reemplaza: 383444, 378231
Metálico- 12 Volt
Utiliza resistencia externa (Para todas Aplicaciones)
Para: 1990 & anteriores con punto de encendido



18-5443
BOBINA ENCENDIDO
Reemplaza: 3854002
4 cil./V-8
Para: 3.0L (1991 & sup), 5.7 EFI (1996 & sup) & 7.4 EFI (1995 & sup)



18-5888
MÓDULO DE ENCENDIDO
Reemplaza: 987738
Para: V-8 colas
Para: 5.0, 5.7 GM (1986-90) 7.5 460 Ford (1987-91)



18-5889
MÓDULO DE ENCENDIDO
Reemplaza: 987739, 985902
Para: V-8 colas
Para: 5.0, 5.8 Ford (1986-90)



18-5890
MÓDULO DE ENCENDIDO
Reemplaza: 987740
Para: 2.3, 3.0, 4.3 (1986-90) & 2.5 (1986)

- ★ Detecta los niveles de corriente en la bobina y ajusta el intervalo para mantener el valor máximo de energía en toda RPM.
- ★ Desarrolla, de media, 4 veces mas energía entre 3000 y 5000 RPM's
- ★ La energía de encendido es estable y la vida de la bobina aumenta cuando el nivel máx. de corriente es alcanzado antes de la chispa
- ★ Distribución más estable.
- ★ Usar con 18-5472 "Flame Thrower II" bobina para un rendimiento optimo



18-5285
KIT CONVERSIÓN ELECTRÓNICO ALTO RENDIMIENTO
Para: 4 Cilindros Distribuidores Delco



18-5287-1
KIT CONVERSIÓN ELECTRÓNICA ALTO RENDIMIENTO
Para: 6 Cilindros distribuidores Prestolite



18-5288
KIT CONVERSIÓN ELECTRÓNICA ALTO RENDIMIENTO
Para: Mayoría de los distribuidores con tapa ajustada con clips Prestolite V-8



18-5289
KIT CONVERSIÓN ELECTRÓNICO ALTO RENDIMIENTO
Para: Mayoría de los distribuidores con encaje la tapa abajo Prestolite V-8



18-5290
KIT CONVERSIÓN ELECTRÓNICA ALTO RENDIMIENTO
Para: Mayoría Mallory YL o YD 8 cilindros distribuidores con rotación hacia la derecha y hacia la izquierda



- ★ Reemplaza platinos & condensador para un buen encendido.
- ★ Usa bobina, tapa y rotor estandar.
- ★ Fácil de instalar, una pieza, 2-conexiones de cables
- ★ Con una tolerancia de 1/4° en el encendido de 0 a 6000 RPM.

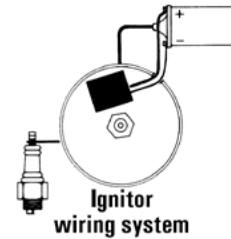
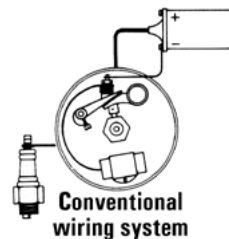

No compatible con módulos asistidos



18-5293-1
KIT CONVERSIÓN ELECTRÓNICA
Para: Todos los Chevrolet V-6 Prestolite con tapa fijada con clips



18-5294
KIT CONVERSIÓN ELECTRÓNICA
Para: 6 Cil. distribuidores Delco



18-5295
KIT CONVERSIÓN ELECTRÓNICA
Para: Mayoría 4 Cil. distribuidores Prestolite (excepto IBM 7026)
Para: Onan, Universal, Waukesha, Wisconsin

No compatibles con módulos asistidos

APLICACIONES EMPIEZAN EN LA PÁGINA 210

① 18-5296-2D

Display Package



**18-5296-2
KIT CONVERSIÓN
ELECTRÓNICA**
Para: Mayoría Mallory YL & YD
8 cil.
Distribuidores con rotación sentido
agujas del reloj y sentido contrario

① 18-5297D

Display Package



**18-5297
KIT CONVERSIÓN
ELECTRÓNICA**
Para 4 Cil. distribuidores Delco



**18-5298
KIT CONVERSIÓN
ELECTRÓNICA**
(Con tapa ajustada con clips)
Para: Mayoría distribuidores Prestolite V-8

① 18-5299D

Display Package



**18-5299
KIT CONVERSIÓN
ELECTRÓNICA**
(Con tapa ajustada con clips)
Para: Mayoría distribuidores
Prestolite V-8
Usar con 18-5403 tipo rotor

No compatible con módulos asistidos



CARACTERÍSTICAS

- ★ Mejora el módulo de encendido con controles de ajuste para mejorar las prestaciones.
- ★ Cojinete y material de alta calidad para una larga vida

Standard Rotation

CCW Rotation

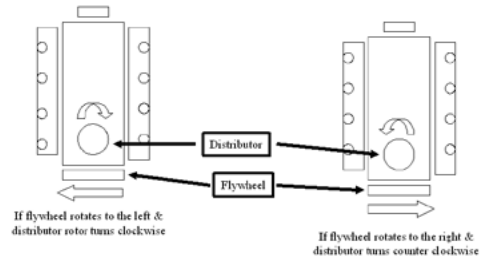

**18-5477
DISTRIBUIDOR ELECTRÓNICO**
Para: Motores Ford 302 V-8
Reemplaza kit Tapa/Rotor 18-5266



**18-5480
KIT COMPLETO CONVERSIÓN
DE ENCENDIDO**
Para: GM SB & BB con altura de cubierta standard
—CONTIENE—
Ref # Descripción
18-5472 Bobina
18-8803-2 Juego de cable
18-5483 Distribuidor



**18-5481
DISTRIBUIDOR ELECTRÓNICO
ALTO RENDIMIENTO**
Para: Ford V-8 351 Windsor
Reemplaza Kit tapa/rotor: 18-5266

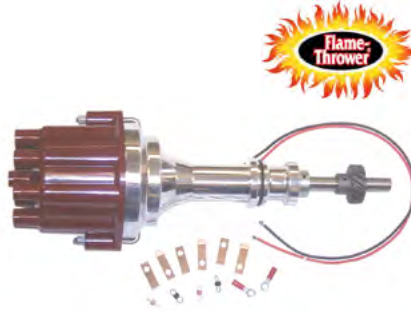

**18-5482
DISTRIBUIDOR ELECTRÓNICO ALTO
RENDIMIENTO**
Para: motores Ford V-8 351 Cleveland, 351M, 400,
429 y 460
Reemplaza kit tapa/roto: 18-5266



**18-5483
DISTRIBUIDOR ELECTRÓNICO ALTO
RENDIMIENTO**
Para: Bloque de motor marino Chevrolet pequeño y
grande (Altura cubierta estándar)
Reemplaza kit tapa/rotor: 18-5266

APLICACIONES EMPIEZAN EN LA PÁGINA 210

① Referencias acabadas en "D" envasadas - referencias normales no envasadas



18-5478
DISTRIBUIDOR ELECTRÓNICO
Para: motores Chrysler LA series V-8
Reemplaza Kit Tapa/Rotor 18-5266



18-5479
DISTRIBUIDOR ELECTRÓNICO
GM V-8 motores rotación reverso
Reemplaza Kit Tapa/Rotor 18-5266



18-5476
DISTRIBUIDOR
Para: Motores GM V-6 con Delco EST encendido HEI
Kit encendido 18-5278



18-5486-2
DISTRIBUIDOR ELECTRÓNICO
Reemplaza: Mallory YLM673AV
Rotación convencional
Para Chevrolet L4, 153 & 181 CID

—CONTIENE—

Ref #	Descripción
18-5397	Tapa distribuidor
18-5488	Modulo
18-5404-1	Rotor



18-5487-2
DISTRIBUIDOR ELECTRÓNICO
Reemplaza: 9-26309, Mallory YLM676AV
Rotación convencional
Para GM L6, 194, 230, 250, 292 CID

—CONTIENE—

Ref #	Descripción
18-5488	Modulo
18-5404-1	Rotor



18-5489-2
DISTRIBUIDOR ELECTRÓNICO
Reemplaza: Mallory YLM554CV
Rotación convencional
Para Ford V8 351W CID

—CONTIENE—

Ref #	Descripción
18-5376	Tapa distribuidor
18-5488	Modulo
18-5404-1	Rotor



18-5494-2
DISTRIBUIDOR ELECTRÓNICO
Reemplaza: Mallory YLM624AV
Rotación convencional
Para todos Chevrolet V8 incluye 482, 502, 540 CID
(Excepto 348, 409 y bloque grande para cubierta alta)

—CONTIENE—

Ref #	Descripción
18-5376	Tapa distribuidor
18-5488	Modulo
18-5404-1	Rotor



18-5495-2
DISTRIBUIDOR ELECTRÓNICO
Reemplaza: Mallory YLM512CV
Rotación convencional
Para Ford V8 302 CID

—CONTIENE—

Ref #	Descripción
18-5376	Tapa distribuidor
18-5488	Modulo
18-5404-1	Rotor



18-5496-2
DISTRIBUIDOR ELECTRÓNICO
Reemplaza: Mallory YLM567CV
Rotación convencional
Para Ford V8 351C — 460 CID

—CONTIENE—

Ref #	Descripción
18-5376	Tapa distribuidor
18-5488	Modulo
18-5404-1	Rotor

18-5484-1
DISTRIBUIDOR ELECTRÓNICO
 Reemplaza: 3857400, 3850399
 Último modelo HEI
Rotación convencional
 V8 262-454 & 502 excepto 348/409 y
 bloques grandes
 *diseñado como reemplazo de enchufe
 para distribuidores de combustible con
 sistema de inyección tipo GM.



—CONTIENE—
 Descripción Ref #
 Tapa distribuidor 18-5354
 Rotor 18-5405
 Kit encendido 18-5281

18-5498-2
DISTRIBUIDOR ELECTRÓNICO
 Reemplaza: 9-26307; Mallory YLM624BV
 Para GM V8, 482, 502, 540 CID (Excepto 348, 409 &
 bloque grande) (Rotación reverso)



18-5339-1
DISTRIBUIDOR
 Reemplaza: 9-26103; Mallory YL566AV
 Para GM V8 327



18-5475
DISTRIBUIDOR
 Para: 4 Cil. Motores GM con Delco EST encendido HEI
 Kit encendido 18-5280



18-5309-1
DISTRIBUIDOR
 Control contacto
 Reemplaza: 980902; Mallory YL512CV
 Para mayoría de motores Ford 302 CID V-8
 Kit encendido 18-5251



18-5316-1
DISTRIBUIDOR
 Reemplaza: Mallory YL624BV
 Para mayoría GM V8 (Rotación reverso)



18-5312-1
DISTRIBUIDOR
 Control contacto
 Reemplaza: 981080; Mallory YL554CV
 Para mayoría de motores Ford 351 CID V-8
 Kit encendido 18-5251



18-5313-1
DISTRIBUIDOR
 Control de contacto
 Reemplaza: 985560; Mallory YL624MW
 Para mayoría de motores GM V-8 (bloque pequeño y
 grande)
 Kit encendido 18-5251



18-5315-1
DISTRIBUIDOR
 Control contacto
 Reemplaza: Mallory YL673AV
 Para mayoría motores GM 4 Cil.(120 & 140 HP)
 Kit encendido 18-5251



18-26110-1
DISTRIBUIDOR
 Reemplaza: 9-26110; Mallory YL579AV
 Para motores Chrysler V8, 273, 318 (1967 & Sup), 340
 y 360 "LA"



18-26104-1
DISTRIBUIDOR
 Reemplaza: 9-26104; Mallory YL567EV
 Para Ford V8 351C



18-26112-1
DISTRIBUIDOR
 Reemplaza: 9-26112; Mallory YL676AV
 Para GM L6, 194, 230, 250, 292 CID (Rotación
 convencional)



OMC TABLA APLICACIÓN CONTACTO

Modelo	Año inicial	Año final	Cilindro	Distribuidor	Condensador	Dist. tapa	Rotor	kit encendido sin tapa	kit encendido con tapa	Juego cable bujía
2.3L	1987	1990	4	Mallory	18-5338	18-5397	18-5404-1	-	18-5283	18-8807-1
2.3L	1990	1990	4	Prestolite	18-5347	-	18-5403	18-5260	-	18-8807-1
2.5L	1981	1986	4	Delco	18-5345	18-5385	18-5418	18-5250	18-5268	18-8800-1
3.0L	1982	1990	4	Delco	18-5345	18-5385	18-5418	18-5250	18-5268	18-8800-1
3.0L	1990	1998	4	Delco EST	N/D	18-5361	18-5406	-	18-5280	18-8833-1
3.8L	1981	1985	6	Prestolite	18-5347	18-5353	18-5403	18-5262	18-5276	18-8801-1
4.3L	1985	1990	6	Prestolite ②	18-5347	18-5353	18-5403	18-5262	18-5276	18-8801-1
4.3L	1991	1993	6	Prestolite	N/D	18-5353	18-5403	-	-	18-8801-1
4.3L	1994	1998	6	Delco EST	N/D	18-53626	18-5408	-	18-5278	18-8835-1
5.0L (GM)	1979	1982	8	Prestolite ①	18-5347	18-5369	18-5407	18-5258	18-5277	18-8802-1
5.0L (GM)	1981	1988	8	Mallory	18-5338	18-5376	18-5404-1	18-5251	18-5271	18-8802-1
5.0L (GM)	1983	1988	8	Prestolite ②	18-5347	18-5352	18-5403	18-5262	18-5275	18-8802-1
5.0L (Ford)	1989	1990	8	Prestolite ②	18-5347	18-5352	18-5403	18-5262	18-5275	18-8806-1
5.0L (Ford)	1991	1996	8	Prestolite	N/D	18-5352	18-5403	-	18-5279	18-8806-1
5.0L (Ford)	1993	1996	8	Ford HEI	N/D	18-5248	18-5413	-	18-29322	18-8820-1
5.0L (GM)	1998	1998	8	Prestolite	N/D	18-5352	18-5403	-	18-5279	18-8801-1
5.0L (GM)	1998	1998	8	Delco EST	N/D	18-5354	18-5405	-	18-5281	18-8822-1
5.7L	1982	1990	8	Mallory	18-5338	18-5376	18-5404-1	18-5251	18-5271	18-8802-1
5.7L	1982	1990	8	Prestolite ②	18-5347	18-5352	18-5403	18-5262	18-5275	18-8802-1
5.7L	1991	1998	8	Prestolite ②	N/D	18-5352	18-5403	-	18-5279	18-8802-1
5.7L	1996	1998	8	Delco EST	N/D	18-5354	18-5405	-	18-5281	18-8822-1
5.8L	1989	1990	8	Prestolite ②	18-5347	18-5352	18-5403	18-5262	18-5275	18-8842-1
5.8L	1991	1996	8	Prestolite ②	N/D	18-5352	18-5403	-	18-5279	18-8842-1
5.8L	1993	1996	8	Ford HEI	N/D	18-5248	18-5413	-	18-29322	18-8820-1
7.4L	1988	1988	8	Mallory	18-5338	18-5376	18-5404-1	18-5251	18-5271	18-8802-1
7.4L	1988	1988	8	Prestolite ②	18-5347	18-5352	18-5403	18-5262	18-5275	18-8802-1
7.4L	1990	1991	8	Distributorless	-	-	-	-	-	18-8843-1
7.4L	1995	1998	8	Delco EST	N/D	18-5354	18-5405	-	18-5281	18-8832-1
7.5L	1987	1987	8	Prestolite ①	18-5347	18-5369	18-5407	18-5258	18-5277	18-8803-2
7.5L	1987	1989	8	Prestolite ①	18-5347	18-5352	18-5407	18-5258	18-5277	18-8803-2
8.2L	1984	1985	8	Mallory	18-5338	18-5376	18-5404-1	18-5251	18-5271	18-8802-1
8.2L	1984	1985	8	Prestolite ②	18-5347	18-5352	18-5403	18-5262	18-5275	18-8802-1
8.2L	1998	1998	8	Delco EST	N/D	18-5354	18-5405	-	18-5281	18-8832-1
80	1962	1968	4	TODOS	18-5200	-	-	18-5001	-	18-8800-1
90	1962	1968	4	TODOS	18-5200	-	-	18-5001	-	18-8800-1
100	1972	1973	4	Delco	18-5345	18-5385	18-5418	18-5250	18-5268	18-8800-1
110	1964	1964	4	Delco	18-5345	18-5385	18-5418	18-5250	18-5268	18-8800-1
120	1965	1981	4	Delco	18-5345	18-5385	18-5418	18-5250	18-5268	18-8800-1
140	1973	1981	4	Delco	18-5345	18-5385	18-5418	18-5250	18-5268	18-8800-1
150	1964	1966	6	Delco	18-5345	-	18-5419	-	-	-
155	1967	1972	6	Delco	18-5344	-	18-5419	-	-	-
165	1972	1976	6	Delco	18-5345	18-5386	18-5418	18-5250	18-5269	-
170	1974	1974	8	Prestolite ①	18-5347	18-5369	18-5407	18-5258	18-5277	18-8802-1
175	1975	1977	8	Prestolite ①	18-5347	18-5369	18-5407	18-5258	18-5277	18-8802-1
185	1967	1968	8	Mallory	18-5338	18-5375	18-5411	18-5256	18-5272	18-8802-1
185	1978	1980	8	Mallory	18-5338	18-5376	18-5404-1	18-5251	18-5271	18-8802-1
185	1978	1980	8	Prestolite ①	18-5347	18-5369	18-5407	18-5258	18-5277	18-8802-1
190	1974	1977	8	Prestolite ①	18-5347	18-5369	18-5407	18-5258	18-5277	18-8802-1
200	1966	1966	8	Delco	18-5345	18-5384	18-5300	-	18-5270	-
200	1967	1968	8	Delco	18-5344	18-5384	18-5300	18-5252	18-5270	-

① Clip tapa distribuidor ② Tornillo tapa distribuidor

APLICACIÓN CONTINUA EN LA SIGUIENTE PÁGINA

OMC TABLA APLICACIÓN CONTACTO

Modelo	Año inicial	Año final	Cilindro	Distribuidor	Condensador	Dist. tapa	Rotor	kit encendido sin tapa	kit encendido con tapa	Juego cable bujía
200	1979	1988	8	Mallory	18-5338	18-5376	18-5404-1	18-5251	18-5271	18-8802-1
200	1979	1981	8	Prestolite ①	18-5347	18-5369	18-5407	18-5258	18-5277	18-8802-1
210	1968	1970	8	Mallory	18-5338	18-5375	18-5411	18-5256	18-5272	18-8802-1
215	1971	1971	8	Mallory	18-5338	18-5375	18-5411	18-5256	18-5272	18-8802-1
225	1972	1976	8	Mallory	18-5338	18-5375	18-5411	18-5256	18-5272	18-8802-1
225	1978	1978	8	Mallory	18-5338	18-5376	18-5404-1	-	18-5271	18-8802-1
230	1979	1981	8	Mallory	18-5338	18-5376	18-5404-1	18-5251	18-5271	18-8802-1
230	1979	1981	8	Prestolite ①	18-5347	18-5369	18-5407	18-5258	18-5277	18-8802-1
230	1975	1976	8	Mallory	18-5338	18-5375	18-5411	18-5256	18-5272	18-8802-1
235	1971	1971	8	Mallory	18-5338	18-5375	18-5411	18-5256	18-5272	18-8802-1
235	1975	1977	8	Prestolite ①	18-5347	18-5369	18-5407	18-5258	18-5277	18-8802-1
240	1978	1978	8	Prestolite ①	18-5347	18-5369	18-5407	18-5258	18-5277	18-8802-1
245	1975	1975	8	Mallory	18-5338	18-5375	18-5411	18-5256	18-5272	18-8802-1
250	1970	1974	8	Mallory	18-5338	18-5375	18-5411	18-5256	18-5272	18-8802-1
250	1979	1979	8	Prestolite ①	18-5347	18-5369	18-5407	18-5258	18-5277	18-8802-1
260	1975	1976	8	Mallory	18-5338	18-5375	18-5411	18-5256	18-5272	18-8802-1
260	1979	1981	8	Mallory	18-5338	18-5376	18-5404-1	18-5251	18-5271	18-8802-1
260	1979	1981	8	Prestolite ①	18-5347	18-5369	18-5407	18-5258	18-5277	18-8802-1
290 JET	1974	1975	8	Mallory	18-5338	18-5375	18-5411	18-5256	18-5272	18-8802-1
305	1977	1979	8	Mallory	18-5338	18-5375	18-5411	18-5256	18-5272	18-8802-1
305	1980	1981	8	Mallory	18-5338	18-5376	18-5404-1	18-5251	18-5271	18-8802-1
305	1981	1981	8	Prestolite ①	18-5347	18-5369	18-5407	18-5258	18-5277	18-8802-1
350	1977	1979	8	Mallory	18-5338	18-5375	18-5411	18-5256	18-5272	18-8802-1
350	1980	1981	8	Mallory	18-5338	18-5376	18-5404-1	18-5251	18-5271	18-8802-1
350	1981	1981	8	Prestolite ①	18-5347	18-5369	18-5407	18-5258	18-5277	18-8802-1
454	1977	1979	8	Mallory	18-5338	18-5375	18-5411	18-5256	18-5272	18-8803-2
454	1980	1981	8	Mallory	18-5338	18-5376	18-5404-1	18-5251	18-5271	18-8803-2
454	1981	1981	8	Prestolite ①	18-5347	18-5369	18-5407	18-5258	18-5277	18-8803-2

① Clip tapa distribuidor ② Tornillo tapa distribuidor



MP28890
HOMBRE AL AGUA
Reemplaza: 176288
Para: 1996 - Sup



MP28880*
HOMBRE AL AGUA
Reemplaza: 432230
Para: 1995-Post.



18-5225
KIT CABLE BUJÍAS
Reemplaza: Mercury 84-99215A26, 84-813706A26
Kit Incluye 25 pies de cable de encendido 7 MM Hypalon de alma de cobre y un amplio surtido de 3 tipos de terminales.



18-5226
CABLE ENCENDIDO
Alma metálica
100' bobina
7mm Hypalon

Pack. de 10



18-5224
18-5224-9②
CABLE TERMINAL ENCENDIDO
Reemplaza: Mercury 20121
OMC 510364

Pack de 10



18-5750
18-5750-9②
TAPA BUJÍAS UNIVERSAL
Suministrado completo con conector terminal
Reemplaza: OMC 581027, 580339



18-5752
TAPA BUJÍAS UNIVERSAL
8mm

③ Precio por pack

CABLES ENCENDIDO PREMIUM MARINE

Sierra MAGFORCE Cables de encendido electrónica protege todos tus dispositivos electrónicos y los controles electrónicos del motor de RFI y EMI, además de ofrecer la máxima cantidad de tensión. Ajuste exacto diseño asegura una fácil instalación - servicio gratuito.

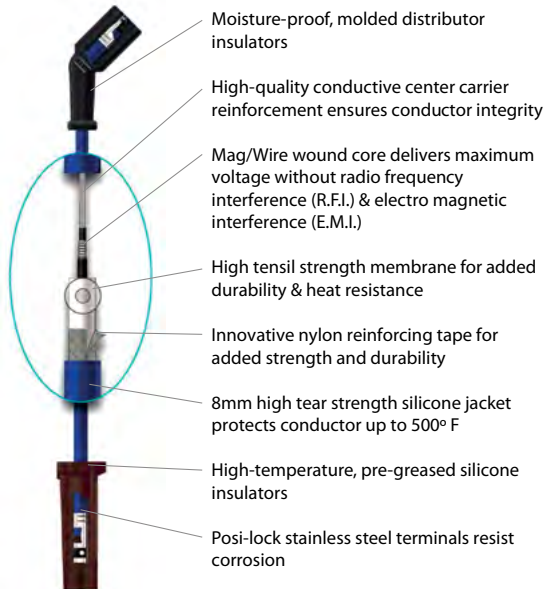

OMC MARINE APLICACIÓN CABLES ENCENDIDO

Modelo	Cil.	Distribuidor	Año inicial	Año final	Juego cable enc
2.3L	4	Mallory	1987	1990	18-8807-1
2.3L	4	Prestolite	1990	1990	18-8807-1
2.5L	4	Delco	1981	1986	18-8800-1
3.0L	4	Delco	1982	1990	18-8800-1
3.0L	4	Delco EST	1990	1998	18-8833-1
3.8L	6	Prestolite	1981	1985	18-8801-1
4.3L	6	Prestolite ②	1985	1990	18-8801-1
4.3L	6	Prestolite	1991	1993	18-8801-1
4.3L	6	Delco EST	1994	1998	18-8835-1
5.0L (GM)	8	Prestolite ①	1979	1982	18-8802-1
5.0L (GM)	8	Mallory	1981	1988	18-8802-1
5.0L (GM)	8	Prestolite ②	1983	1988	18-8802-1
5.0L (Ford)	8	Prestolite ②	1989	1990	18-8806-1
5.0L (Ford)	8	Prestolite	1991	1996	18-8806-1
5.0L (Ford)	8	Ford HEI	1993	1996	18-8820-1
5.0L (GM)	8	Prestolite	1998	1998	18-8801-1
5.0L (GM)	8	Delco EST	1998	1998	18-8822-1
5.7L	8	Mallory	1982	1990	18-8802-1
5.7L	8	Prestolite ②	1982	1990	18-8802-1
5.7L	8	Prestolite ②	1991	1998	18-8802-1
5.7L	8	Delco EST	1996	1998	18-8822-1
5.8L	8	Prestolite ②	1989	1990	18-8842-1
5.8L	8	Prestolite ②	1991	1996	18-8842-1
5.8L	8	Ford HEI	1993	1996	18-8820-1
7.4L	8	Mallory	1988	1988	18-8802-1
7.4L	8	Prestolite ②	1988	1988	18-8802-1
7.4L	8	Distributorless	1990	1991	18-8843-1
7.4L	8	Delco EST	1995	1998	18-8832-1
7.5L	8	Prestolite ②	1987	1987	18-8803-2
7.5L	8	Prestolite ②	1987	1989	18-8803-2
8.2L	8	Mallory	1984	1985	18-8802-1
8.2L	8	Prestolite ②	1984	1985	18-8802-1
8.2L	8	Delco EST	1998	1998	18-8832-1

OMC MARINE APLICACIÓN CABLES ENCENDIDO

Modelo	Cil.	Distribuidor	Año inicial	Año final	Juego cable enc
80	4	ALL	1962	1968	18-8800-1
90	4	ALL	1962	1968	18-8800-1
100	4	Delco	1972	1973	18-8800-1
110	4	Delco	1964	1964	18-8800-1
120	4	Delco	1965	1981	18-8800-1
140	4	Delco	1973	1981	18-8800-1
170	8	Prestolite ①	1974	1974	18-8802-1
175	8	Prestolite ①	1975	1977	18-8802-1
185	8	Mallory	1967	1968	18-8802-1
185	8	Mallory	1978	1980	18-8802-1
185	8	Prestolite ①	1978	1980	18-8802-1
190	8	Prestolite ①	1974	1977	18-8802-1
200	8	Mallory	1979	1988	18-8802-1
200	8	Prestolite ①	1979	1981	18-8802-1
210	8	Mallory	1968	1970	18-8802-1
215	8	Mallory	1971	1971	18-8802-1
225	8	Mallory	1972	1976	18-8802-1
225	8	Mallory	1978	1978	18-8802-1
230	8	Mallory	1979	1981	18-8802-1
230	8	Prestolite ①	1979	1981	18-8802-1
230	8	Mallory	1975	1976	18-8802-1
235	8	Mallory	1971	1971	18-8802-1
235	8	Prestolite ①	1975	1977	18-8802-1
240	8	Prestolite ①	1978	1978	18-8802-1
245	8	Mallory	1975	1975	18-8802-1
250	8	Mallory	1970	1974	18-8802-1
250	8	Prestolite ①	1979	1979	18-8802-1
260	8	Mallory	1975	1976	18-8802-1
260	8	Mallory	1979	1981	18-8802-1
260	8	Prestolite ①	1979	1981	18-8802-1
290 JET	8	Mallory	1974	1975	18-8802-1
305	8	Mallory	1977	1979	18-8802-1

① clip tapa ② Encaje bajo tapa

OMC MARINE APLICACIÓN CABLES ENCENDIDO					
Modelo	Cil.	Distribuidor	Año inicial	Año final	Juego cable enc
305	8	Mallory	1980	1981	18-8802-1
305	8	Prestolite ①	1981	1981	18-8802-1
350	8	Mallory	1977	1979	18-8802-1
350	8	Mallory	1980	1981	18-8802-1

OMC MARINE APLICACIÓN CABLES ENCENDIDO					
Modelo	Cil.	Distribuidor	Año inicial	Año final	Juego cable enc
350	8	Prestolite ①	1981	1981	18-8802-1
454	8	Mallory	1977	1979	18-8803-2
454	8	Mallory	1980	1981	18-8803-2
454	8	Prestolite ①	1981	1981	18-8803-2

① clip tapa ② Encaje bajo tapa

18-5920
ARRANQUE, PMGR, FORD
 PMGR Reemplaza por 18-5903; 302CID,
 351CID motor Ford
 rotación agujas del reloj/Rotación standard



18-5927
ARRANQUE, PMGR, FORD
 PMGR reemplaza por 18-5917,
 2.3L arranque Ford.



18-6270
MOTOR DE ARRANQUE
 Reemplaza: 988013,
 984536
 • Magneto permanente
 • Heavy Duty
 • 12 Volt

- 1 agujero rosca
 - Rotación estándar
 - SAE J1171
- Para: 460 Ford, OMC King Cobra
 2 tornillos



18-5919
MOTOR ARRANQUE
 Magneto permanente
 I/O arranque
 Para: Último modelo GM -
 12 3/4" volante
 Reemplaza: 988217
 Reemplaza Solenoide: 18-6287
 SAEJ1171
 1.7 KW



18-5920
MOTOR ARRANQUE
 Magneto permanente
 Para: 5.0 & 5.8 litros.
 Rotación estándar
 Reemplaza: 987811, 3854190
 Solenoide reemplazo: 18-6291



Standard Rotation

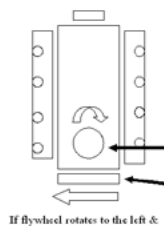

If flywheel rotates to the left & distributor rotor turns clockwise

CCW Rotation

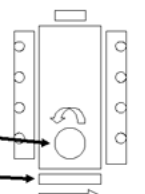

If flywheel rotates to the right & distributor turns counter clockwise

18-6276
MOTOR ARRANQUE
 Reemplaza: 984536, 988013
 • 12 Volt
 • Rotación estándar
 • agujero rosca
 • 460 Ford, OMC King Cobra



18-5911
MOTOR DE ARRANQUE
 (Heavy-Duty) (Sin núcleo)
 Para motores GM, montaje inferior, tornillos paralelos.
 Rotación estándar. 100-245 HP — 1970-1978 (GM)
 Reemplaza: 981078, 982121, 983444, 983790, 985966
 Solenoide reemplazo: 18-5837
 SAEJ1171



18-5907
STARTER
 (Heavy-Duty) (Sin núcleo)
 Montaje superior, entrada posterior.
 Motores GM y Ford.
 Reemplaza: 981289, 982202
 Solenoide reemplazo: 18-5837
 SAEJ1171





18-5908
MOTOR ARRANQUE
(Heavy-Duty)
Montaje superior, entrada posterior
GM y motores ford. rotación estándar.
Reemplaza: 981288, 982195, 984982, 986007
Solenoid reemplazo: 18-5837
SAEJ1171



18-5910
MOTOR ARRANQUE
(Heavy-Duty)
Bloques pequeño GM V-6 & V-8 con volante 14 1/4" y montaje inferior, Tornillos desplazados. Rotación estándar. 1986-1992 - V-6, V-8 (GM) y 1990-1993 OMC King Cobra
Reemplaza: 984456, 986505
Solenoid reemplazo: 18-5837
SAEJ1171



18-5917
MOTOR ARRANQUE
Reemplaza: 984628
3 tornillos - Diámetro 4" Rotación estándar.
Rotación estándar Para: Último modelo Ford V-8. Solenoid reemplazo: 18-5801



18-5903
MOTOR ARRANQUE
(Rotación agujas del reloj)
Montaje inferior, 2 tornillos. Motores ford. rotación agujas del reloj.
Sin agujero rosca superior. Para rosca superior, 18-6276.
Reemplaza: 980803, 981821
Solenoid reemplazo: 18-5801



18-5913
MOTOR ARRANQUE
(Rotación agujas del reloj)
Magnético permanente. 2 tornillos 12V - 11 dientes. Para: Motores Chevy con volante 14". 1.7 KW
Reemplaza: 3854751 SAEJ1171
Reemplaza solenoid: 18-6287

MOTORES DE ARRANQUE COLAS OMC/OMC COBRA

Motor	Año	Motor arranque	Motor	Año	Motor arranque	Motor	Año	Motor arranque
3.0L	1982-92	18-5911	170	1974	18-5903	245	1972-75	18-5911
5.0L	1982-86	18-5911 ④	175	1975-77	18-5903	245 JET	1972-74	18-5911
5.0L	1986-88	18-5910 ⑤	185	1967-68,		250	1979	18-5903
2.5L	1982-86	18-5911		1978-80	18-5911	260	1975-76	18-5908 ①
3.8L	1981-86	18-5911	190	1974-77	18-5903	260	1975-76	18-5907 ②
4.3L	1985-86	18-5911	200	1966-68,		260	1979-81	18-5911
4.3L	1986-92	18-5910		1979-81	18-5911	262 CID	1989	18-5910
5.7L	1982-86	18-5911	210	1968-72	18-5911 ①	290	1975	18-5908 ③
5.7L	1986-92	18-5910	215	1971	18-5911	305 CID	1977-80,82	18-5908 ①
100	1972-73	18-5911	225	1972-76,		305 CID	1977-80,82	18-5907 ②
110	1964	18-5911		1978	18-5911 ①	350 CID	1977-80,82	18-5908 ①
120	1965-81	18-5911	230	1975-76	18-5908 ①	350 CID	1977-80,82	18-5907 ②
140	1973-81	18-5911	230	1975-76	18-5907 ②	350 CID	1988-91	18-5910
140 JET	1973	18-5911	230	1979-81	18-5911	370 CID	1988	18-5908
150	1964-66	18-5911	235	1971	18-5911	454 CID	1977-80,82	18-5908 ①
155	1967-72	18-5911	235	1975-77	18-5903	454 CID	1977-80,82	18-5907 ②
165	1972-76	18-5911	240	1978	18-5903	454 CID	1990-92	18-5910
						502 CID	1992	18-5910

① Motores de rotación estándar.

② Motores con contra-rotación.

③ Motores con modelo número sufijo "R2" or "R3"

④ Motores modelo '86 con número sufijo "WB"

⑤ Motores modelo '86 con número sufijo "XS"



18-5717
JUEGO ESCOBILLAS
Reemplaza:
Delco 1984462



18-8412
EXTENSOR DE ESPÁRAGO DE ARRANQUE
Alarga los terminales del solenoide en arranques PMGR.



18-5811
SOLENOIDE MOTOR ARRANQUE
Reemplaza: 3850216
Para: PG 260 serie motor arranque, GM V6 & V8 (1983-sup)



18-5801
SOLENOIDE
Reemplaza: 985064, 586842,
586730
Base a tierra

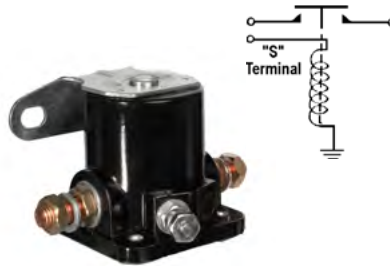
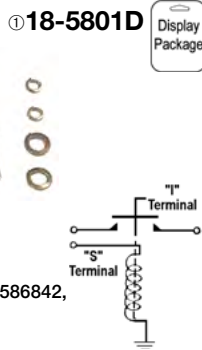

18-5803
SOLENOIDE
Reemplaza: 979774

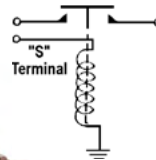

18-5807
SOLENOIDE
Reemplaza: 378444
Prestolite SAW4206

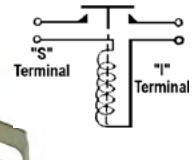

18-6291
SOLENOIDE
Reemplaza: 3854194 y Volvo Penta 3854194-2
Para: Ford en últimos modelos 5.0L, 5.8L, OMC y Volvo Penta



18-5814
SOLENOIDE
Reemplaza: 172869, 581528
12 Volt, Base aislada

① 18-5814D Display Package

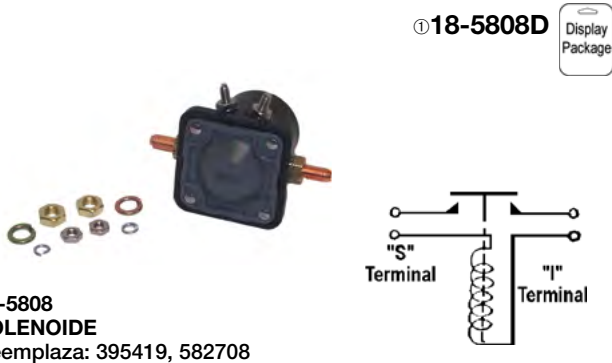

18-5808
SOLENOIDE
Reemplaza: 395419, 582708

① 18-5808D Display Package

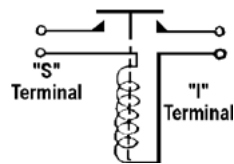

18-5812
SOLENOIDE
Reemplaza: 985063

① 18-5812D Display Package

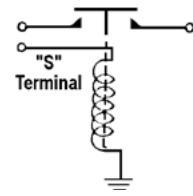

18-5837
SOLENOIDE
Reemplaza: 985799, 986620
Delco 1114531

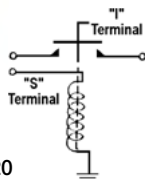

18-5838
SOLENOIDE
Reemplaza:
Delco 1114356, 1114458

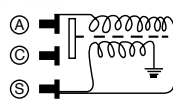

CABLES DE BATERÍAS
Cable calibrado con terminales soldados en cada extremo. Acepta tornillos de 3/8"

Ref.	long.	Color	cal.	Ref.	long.	Color
BC88523	2'	rojo	4	BC88563	6'	rojo 2
BC88533	2'	negro	4	BC88573	6'	negro 2
BC88543	4'	rojo	2	BC88583	8'	rojo 1
BC88553	4'	negro	2	BC88593	8'	negro 1

① Referencias acabadas en "D" envasadas - Referencias normales no envasadas

APLICACIÓN SOLENOIDE

HP	Año	Escobillas Motor arranque	Solenoides Motor arranque	Solenoides arranque	Solenoides Tilt	Solenoides Trim
80	1969	—	N/D	18-5808	N/D	18-5808
88	1964	—	N/D	18-5807	N/D	18-5807
90	1965-71	—	N/D	18-5808	N/D	18-5808
100	1972-73	18-5717	18-5838	18-5803	N/D	18-5803
110	1964	18-5717	18-5838	18-5807	N/D	18-5807
120	1965-71	18-5717	18-5838	18-5808	N/D	18-5808
120	1972-77	18-5717	18-5838	18-5803	18-5803	18-5803
120	1978-81	18-5717	18-5838	—	—	—
140	1973-77	18-5717	18-5838	18-5803	18-5803	18-5803
140	1978-81	18-5717	18-5838	—	—	—
145	① 1973	—	18-5838	18-5803	N/D	N/D
150	1964	18-5717	18-5838	18-5807	N/D	18-5807
150	1965-66	18-5717	18-5838	18-5808	N/D	18-5808
155	1967-72	18-5717	18-5838	18-5808	N/D	18-5808
165	1972-76	18-5717	18-5838	18-5803	18-5803	18-5803
170	1974	—	N/D	18-5801	N/D	18-5803
175	1975-78	—	N/D	18-5801	N/D	18-5803
185	1967-68	18-5717	18-5838	18-5808	N/D	18-5808
185	1978-80	18-5717	18-5838	—	—	—
190	1974-78	—	N/D	18-5801	N/D	18-5803
200	1966-78	18-5717	18-5838	18-5808	N/D	18-5808
200	1979-81	—	18-5838	—	—	—
210	1968-70	18-5717	18-5838	18-5808	N/D	18-5808
210	② 1970-72	18-5717	18-5838	18-5808	N/D	N/D
215	1971	18-5717	18-5838	18-5808	N/D	18-5808
225	1972	18-5717	18-5838	18-5808	N/D	18-5808
225	1973	18-5717	18-5838	18-5803	N/D	18-5808
225	1974-76	18-5717	18-5838	18-5803	N/D	18-5803
225	1978	18-5717	18-5838	—	—	—
225	② 1973-74	18-5717	18-5838	18-5808	N/D	N/D
230	② 1975-76	18-5717	18-5838	18-5803	N/D	N/D
230	1979-81	18-5717	18-5838	—	—	—
235	1971	18-5717	18-5838	18-5808	N/D	18-5808
235	1975-78	—	N/D	18-5801	N/D	18-5803
245	1972	18-5717	18-5838	18-5808	N/D	18-5808
245	1973	18-5717	18-5838	18-5803	N/D	18-5808
245	1974-75	18-5717	18-5838	18-5803	N/D	18-5803
245	① 1972-75	18-5717	18-5838	18-5808	N/D	N/D
250	② 1970-74	—	18-5838	18-5808	N/D	N/D
260	② 1975-76	18-5717	18-5838	18-5803	N/D	N/D
260	1979-81	18-5717	18-5838	—	—	—
290	① 1974-75	18-5717	18-5838	18-5808	N/D	N/D
305	② 1977-82	18-5717	18-5838	—	N/D	N/D
350	② 1977-82	18-5717	18-5838	—	N/D	N/D
454	② 1977-82	18-5717	18-5838	—	N/D	N/D
2.5	1982	18-5717	18-5838	—	—	—
2.5	1983-86	18-5717	18-5837	—	—	—
3	1982	18-5717	18-5838	—	—	—
3	1983-86	18-5717	18-5837	—	—	—
3.8	1981-82	18-5717	18-5838	—	N/D	—
3.8	1983-86	18-5717	18-5837	—	N/D	—
4.3	1985-86	18-5717	18-5837	—	N/D	—
5	1982	18-5717	18-5838	—	—	—
5	1983-86	18-5717	18-5837	—	—	—
5.7	1982	18-5717	18-5838	—	—	—
5.7	1983-86	18-5717	18-5837	—	—	—

① Jet

② Intraborda

APLICACIÓN SOLENOIDE OMC COBRA

HP	Año	Escobillas Motor arranque	Solenoides Motor de arranque	Solenoides Arranque	Solenoides Trim
262	1989	N/D	18-5837	18-5812	N/D
350	1988	N/D	18-5837	18-5812	18-5812
350	1989	N/D	18-5837	18-5812	N/D
350	1990-91	N/D	18-5837	18-5801	N/D
351	1992	—	—	18-5801	N/D
370	1988	N/D	—	18-5812	18-5812
370	1989	N/D	—	18-5812	N/D
454	1990	—	—	18-5801	N/D
454	1991-92	N/D	18-5837	18-5801	N/D
460	1989-90	N/D	—	18-5801	N/D
502	1992	N/D	18-5837	18-5801	N/D
2.3	1987-88	N/D	—	18-5801	18-5812
2.3	1989-90	N/D	—	18-5801	N/D
2.5	1986	18-5717	18-5837	18-5812	18-5812
3	1986-88	18-5717	18-5837	18-5812	18-5812
3	1989-90	18-5717	18-5837	18-5812	N/D
3	1991-92	18-5717	18-5837	18-5801	N/D
4.3	1986-88	18-5717	18-5837	18-5812	18-5812
4.3	③ 1989-90	18-5717	18-5837	18-5812	N/D
4.3	④ 1990-92	18-5717	18-5837	18-5801	N/D
5	1986-88	18-5717	18-5837	18-5812	18-5812
5	1989-92	18-5717	—	18-5801	N/D
5.7	1986-88	18-5717	18-5837	18-5812	18-5812
5.7	1989	18-5717	18-5837	18-5812	N/D
5.7	1990-92	18-5717	18-5837	18-5801	N/D
5.8	1989-92	N/D	—	18-5801	N/D
7.5	1987	18-5717	—	18-5801	18-5812

③ 1990 Modelos con 2 cuerpos carbs④ 1990 Modelos con 4 cuerpos carbs.

18-5711
REGULADOR VOLTAJE
 Reemplaza: 383440
 Prestolite: VSH-6201 AFY
 12 Volt



Años	Modelo	Alternador o Generador
1964-66	110, 150 HP	ALK-6222, A, AYS
1967-81	80, 90, 120, 140, 155, 165, 175	ALK-6222, A, AY, Y, AYS
	185, 190, 200, 210, 225, 230, 235, 250, 260 HP & 305, 350, 454 CID	ANK-65201S, Y ALK-6210, A

18-6261
ALTERNADOR
 Reemplaza: 987774, 3857561, 3854182, 3854809, 3856600, 3860171
 Para: 3.0L, 4.3L, 5.7L, 7.4L (1995-98), 5.0L, 5.8L, 8.2L (1993-98)
 Para: Delco



18-6260
ALTERNADOR
 OMC Cobra 12 Volt, 51 Amp, regulador interno, Negativo, Polea de renura única
 Para: Prestolite/Motorola



18-6841
ALTERNADOR
 Reemplaza: 983424, 836, 247
 Para: 37-63A Aplicaciones marinas



18-5957
ALTERNADOR
 Reemplaza: 982364 (3-cables) (68 AMP)
 Reemplaza Mando, Motorola y equipo original Delco. Usa las mismas conexiones eléctricas y montaje. Equipado con ventilador y polea. SAEJ1171



18-2192
CABLE CAMBIO ELÉCTRICO
 Reemplaza: 379628

APLICACIÓN CABLE CAMBIO ELÉCTRICO

Año	HP
1964	110 ②, 150
1965	120 ①, 150
1966	120 ①, 150, 200
1967	120 ①, 155, 185, 200
1968	120, 155, 185, 200, 210
1969-70	120, 155, 210
1971	120, 155, 215, 235
1972-73	100, 120, 155, 165, 225, 245
1974	120, 140, 165, 170, 190, 225, 245
1975	120, 140, 165, 175, 190, 225, 235, 245
1976	120, 140, 165, 175, 190, 225, 235
1977	120, 140, 175, 190, 235

① Heavy Duty ② SU12M, SUE 12M

③ 18-5705D



18-5705
RELÉ POWER TRIM
 Reemplaza: 582472, 584416, 586224
 5 Terminales



tipo único - Doble emp - 12 Volt
 Contacto abierto: 40 Amps Resistencia
 30 Amps Conductividad
 Contacto cerrado: 20 Amps Resistencia
 15 Amps Conductividad

18-6257
MOTOR TILT/TRIM
 Reemplaza: 983195, 982957
 1982-85 Modelos con motor hidráulico levantados para montaje de bomba



18-6754
MOTOR TILT
 Reemplaza: 382138
 Prestolite ETK 4102, ETK 4001, ETK 4101 (todos los modelos 1963-77)



18-6755
MOTOR TILT
 Reemplaza: 982706, 982058
 Prestolite EVD 4001, EVD 4002 (Todos Excepto 2.5L, 3.0L - 1978-85)





18-6764
MOTOR TILT/TRIM
Reemplaza: 982073,
983318, 982069
Para: OMC Stringer y Cobra
"Select Trim" 3-cables de Conexión
1979-85 Colas (2.5L & 3.0L)



18-6779
MOTOR TRIM
Reemplaza: 986280, 3853945
Para: 1990 & 1994 sistema King Cobra Trim



18-6814
MOTOR TRIM
Reemplaza: 984356
OMC Cobra



18-6823
CABLEADO
Reemplaza: Universal
Convierte motores de Trim y Tilt de 3 a 2 cables



18-6950
18-6950-9^①
FUSIBLE POWER TRIM
(50 amp)
Reemplaza: 982019



18-9802
PISTOLA POWER TRIM
Hasta 10,000 RPM's



18-7601
SENSOR DE TEMPERATURA
Reemplaza: 3854158
8 cil
5.0L, 5.8 L, EFI (1994-96)



18-7684
SENSOR DE PICADO
Reemplaza: 3850396
Para: 4.3L TBI(1996-98), 5.0L TBI(1998), 5.7L
TBI(1996-98), 7.4L(1995-98), 8.2L(1998)



18-7677
SENSOR DE GOLPE
Reemplaza: 3850357



18-7679
SENSOR DE GOLPE
Reemplaza: 3854905



18-7703
SENSOR DE GOLPE
Reemplaza: 3854512



18-7689
INYECTOR COMBUSTIBLE
Reemplaza: 3855182

TODOS LOS CARBURADORES INCLUYEN JUNTA BASE

- *Precisión remanufacturada para alcanzar o exceder las especificaciones OEM*
- *Recalibrados y reprogramados para maximizar la eficiencia y rendimiento del combustible*
- *Prueba de flujo por todas partes del regulador a todos los carburadores*
- *La mezcla de combustible y ajustes ociosos son predeterminados para asegurar que sólo el menos ocioso y ajustes de estrangulador son necesarios durante la instalación.*
- *Todas las bases son revestidas de nuevo y los manguitos del eje regulador sustituidos*



18-7635
CARBURADOR
(REMANUFACTURADO)
300 CFM Holley 2V
Use junta de recambio 18-0360



18-7636
CARBURADOR
(REMANUFACTURADO)
500 CFM Holley 2V
Use junta de recambio 18-0994



18-7637
CARBURADOR
(REMANUFACTURADO)
600 CFM Holley 4V
(Incluye junta)



18-7638
CARBURADOR
(REMANUFACTURADO)
600 CFM Holley 4V-entrada lateral



18-7640
CARBURADOR
(REMANUFACTURADO)
Universal Q-jet con estrangulador eléctrico
Use junta recambio 18-0462



18-7605-1
CARBURADOR
4 Barrel Rochester
Reemplaza: 382821, 383766, 384194
Remanufacturado
Use junta de recambio 18-2948
Use kit carb de recambio 18-7095



18-7608-1
CARBURADOR
2 Barrel Rochester
Reemplaza: 381668, 980528, 982219, 982217
Remanufacturado
Use junta de recambio 18-0356
Use kit carb de recambio 18-7070



18-80006
CARBURADOR
(Remanufacturado)
Reemplaza: R80382
Para: 5.0, 5.8L, Fi, FL, SX con 2bbl Holley



18-80008
CARBURADOR
(Remanufacturado)
Reemplaza: R7044289
Para: 7.4L con 4 bbl Rochester



18-80009
CARBURADOR
(Remanufacturado)
Reemplaza: R80378
Para: 7.4L Gi, GL, Gsi & 8.2L GL



18-7609-1
CARBURADOR
2 Barrel Rochester
Reemplaza: 382733, 980530, 982217, 984180, 381494, 772831
Remanufacturado
Use junta recambio 18-0356
Use kit carb recambio 18-7070



18-7615-1
CARBURADOR
4 Barrel Rochester
Reemplaza: 981705, 982223, 983855, 981359, 981564, 985822, 981803, 981428
Remanufacturado
Use junta recambio 18-2948
Use kit carb recambio 18-7095



18-7615N
CARBURADOR Q-JET
Reemplaza: 1347-816373A4, 1347-804624R1, 1347-804624R02
(Incluye junta)
Use kit carb recambio 18-7095

APLICACIONES COLAS CARBURADOR OMC

Modelo	Año	OMC Carburador #	MFG Carburador #	Codigo Carb & Modelo	Ref #
80	1968-69	382733, 772831	7028085, 17059053, 17086064, 17087311	R2, 2GC	18-7609-1
90	1970-71	382733, 772831	7028085, 17059053, 17086064, 17087311	R2, 2GC	18-7609-1
120 (400 Series)	1972-86	381668, 980528, 982219	7044186, 17059056	R2, 2GC	18-7608-1
140 (400 Series)	1973-85	979821, 980530, 982217, 984180	17086107	R2, 2GC	18-7608-1
155	1967-72	772831	7026180	R2, 2GC	18-7609-1
165	1972-76	979821, 980530	17086107	R2, 2GC	18-7609-1
185	1989	984180	17086064	R2, 2GC	18-7609-1
200	1966-68	381494	7025187	R2, 2GC	18-7609-1
210	1968-72	382821, 383766	7028282, 7028280	R4, 4MV	18-7605-1
215, 225, 230	1971-76	382821	7028280	R4, 4MV	18-7605-1
230 (800 Series)	1979-89	981705, 982223	17057290, 17059285, 17059286, 17086117	R4, 4MV	18-7615-1
245	1972-75	384194	7040284	R4, 4MV	18-7605-1
250	1970-74	384194	7040284	R4, 4MV	18-7605-1
260 (800 Series)	1975-76	384194	7040284	R4, 4MV	18-7605-1
260 (800 Series)	1979-89	982223	17057290, 17059285, 17059286, 17086117	R4, 4MV	18-7615-1
2.5L, 3.0L	1982-86	982219, 982217	17059056, 17059053	R2, 2GC	18-7608-1
3.0L	1987-90	984180	17086064	R2, 2GC	18-7608-1
3.8L (4V)	1979-85	983855	17082515, 17085010	R4, 4MV	18-7615-1
4.3L (4V)	1979-89	983855	17082515, 17085010	R4, 4MV	18-7615-1
5.0L (GM)(4V)	1979-89	982223	17057290, 17059285, 17059286, 17086117	R4, 4MV	18-7615-1
5.7L (4V)	1979-89	982223	17057290, 17059285, 17059286, 17086117	R4, 4MV	18-7615-1
305, 350 CI, I/B	1977-83	981359, 982215, 981564, 982223	17057290, 17059285, 17059286, 17086117	R4, 4MV	18-7615-1
350 (4V)	1988-89	985822	17057290, 17059285, 17059286, 17086117	R4, 4MV	18-7615-1
454 CI, I/B	1977-78	981803, 981428	17057290, 17059285, 17059286, 17086117	R4, 4MV	18-7615-1



**18-7017
KIT CARBURADOR**
Reemplaza: 985052
235 (5.8L Ford) 1989 7.5L/460 C.I. 1987-89
(Contiene agujas y asientos ajustables)



**18-7018
KIT CARBURADOR**
Reemplaza: 982352
350 C.I. Intraborda 1977-78



**18-7070
KIT CARBURADOR**
Reemplaza: 383615, 982384



**18-7071
KIT CARBURADOR**
Reemplaza: 380186



**18-7072
KIT CARBURADOR**
Reemplaza: 979659, 384743



**18-7080
KIT CARBURADOR**
Reemplaza: 979719



**18-7081
KIT CARBURADOR**
Reemplaza: 982537, 982538,
(Contiene agujas y asientos ajustables)



**18-7086
KIT CARBURADOR**
Reemplaza: 984487

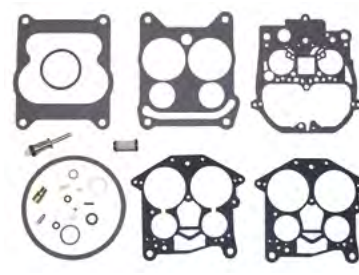

**18-7095
KIT CARBURADOR**
Reemplaza: 983864, 383918

**OMC
COLAS/COBRA - Sistema combustible**



18-7096
KIT CARBURADOR
Reemplaza: 982539, 85R-4541
(Contiene agujas y asientos ajustables)



18-7235
KIT CARBURADOR
Reemplaza: 986783



18-7236
KIT CARBURADOR
Reemplaza: 986782



18-7237
KIT CARBURADOR
Reemplaza: 986784, 986799



18-7238
KIT CARBURADOR
Reemplaza: 986796



18-7239
KIT CARBURADOR
Reemplaza: 986800



18-7241
KIT CARBURADOR
Reemplaza: 986804



18-7242
KIT CARBURADOR
Reemplaza: 987313



18-7243
KIT CARBURADOR
Reemplaza: 987315

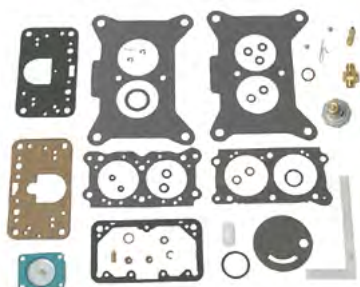

18-7244
KIT CARBURADOR
Reemplaza: 987317



18-7245
KIT CARBURADOR
Reemplaza: 987319



18-7246
KIT CARBURADOR
Reemplaza: 987438, 987440, 987485



18-7727
KIT CARBURADOR



18-7729
KIT CARBURADOR

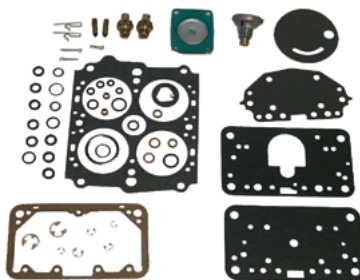

18-7730
KIT CARBURADOR

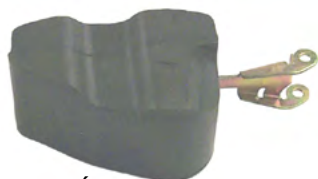

18-7200
FLOTADOR LATÓN
(Resistente al alcohol)
Reemplaza: 381389
Latón



18-7201
FLOTADOR LATÓN
(Resistente al alcohol)
Reemplaza: 383087, 983871
Latón



18-7206
FLOTADOR NITROPHILO
Nitrophilo

APLICACIÓN KIT CARBURADOR/FLOTADOR

Modelo	Años	Código Fabricación	Modelo Carburador	Kit Carburador	Flotador
80	1968-69	R2	2GC	18-7070	18-7200
90	1970-71	R2	2GC	18-7070	18-7200
100	1972-73	C1	RBS	18-7080	—
110	1964	R1	BC	18-7071	—
120	1965-71 (Dual Carb)	C1	RBS	18-7080	—
120	1972-85	R2	2GC	18-7070	18-7200
140	1973-85	R2	2GC	18-7070	18-7200
150	1964-65	R1	BC	18-7071	—
150	1965-66	C1	RBC	18-7080	—
155	1967-72	R2	2GC	18-7070	—
165	1972-76	R2	2GC	18-7070	18-7200
170	1974	H2	2300	18-7081	18-7206
175	1975-77	H2	2300	18-7081	18-7206
185	1978-81	R2	2GE	18-7086	18-7200
185	1989	H2	2300	18-7081	18-7206
190	1974-77	H2	2300	18-7081	18-7206
200	1966-68	R2	2GC,V	18-7070	—
200	1979-85	R2	2GE	18-7086	18-7200
200	1989	H2	2300	18-7081	18-7206
210	1968-72	R4	4MV	18-7072	18-7201
215	1971	R4	4MV	18-7072	18-7201
225	1972-76	R4	4MV	18-7072	18-7201
230	1975-76	R4	4MV	18-7072	18-7201
230	1979-89	R4	4MV	18-7095	18-7201
235	1975-77	H4	4160	18-7096	18-7206
235	1989	H4	4160	18-7017	—
240	1978	H4	4160	18-7017	—
245	1972-75	R4	4MV	18-7072	18-7201
250	1970-74	R4	4MV	18-7072	18-7201
250	1979	H4	4160	18-7017	—
260	1975-76	R4	4MV	18-7072	18-7201
260	1979-89	R4	4MV	18-7095	18-7201
290 JET	1974-75	R4	4MV	18-7072	18-7201
2.3L	1987-89	R2	2GE	18-7086	18-7200
2.5L	1982-85	R2	2GC	18-7070	18-7200
2.5L	1986-90	R2	2GE	18-7086	18-7200
2.5L	1986	R2	2GC	18-7070	18-7200
3.0L ^⑥	1982-90	R2	2GC	18-7070	18-7200
3.0L/3.0L H.O.	1991-92	H-2	2300	18-7246	N/D
3.8L	1979-85	R2	2GE	18-7086	18-7200
4.3L	1986-89	R2	2GE	18-7086	18-7200
4.3L	1979-89	R4	4MV	18-7095	18-7201
4.3,4.3 H.O. ^②	1990-92	H2	2300	18-7238	N/D
4.3,4.3 H.O. ^③	1990-92	H4	4160	18-7237	N/D
4.3/262 ^②	1989	R2	2GE	18-7086	18-7200
5.0L (GM)	1979-85	R2	2GE	18-7086	18-7200
5.0L (GM)	1979-89	R4	4MV	18-7095	18-7201
5.0L (FORD)	1989	H2	2300	18-7081	18-7206
5.0,5.0 H.O. ^③	1989-90	H4	4160	18-7237	N/D
5.0,5.0 H.O. ^②	1989-90	H2	2300	18-7236	N/D
5.0,5.0 H.O. ^③	1991	H4	4160	18-7245	N/D
5.0,5.0 H.O. ^②	1991	H4	4175	18-7244	N/D
5.0,5.0 H.O. ^①	1992	H4	4150	18-7242	N/D
5.7L	1979-89	R4	4MV	18-7095	18-7201
5.7	1990-92	H4	4175	18-7239	N/D
5.7 LE ^⑨	1991-92	H4	4175	18-7243	N/D
5.7 LE ^④	1990	H4	4175	18-7239	N/D
5.8L	1989	H4	4160	18-7017	—
7.5L	1987-88	H4	4160	18-7017	—
305 C.I./B	1977-79	R2	2GE	18-7086	18-7200
305 C.I./B	1977-78	R4	4MV	18-7018	18-7201
305 C.I./B	1979-83	R4	4MV	18-7095	18-7201
350 C.I./B	1977-78	R4	4MV	18-7018	18-7201

^② Para carburadores 2V

^③ Para carburadores 4V

^④ Para modelo motor 574APEPWS

^⑥ Para 1990 PWC Sólo sufijo

^⑨ Para modelo motor 574APERGD

^① Para modelo motor 744DPEAMH, 744DPPAMH

^② Para modelo motor 744CPEAMH, 824BPEAM

APLICACIÓN KIT CARBURADOR/FOTADOR (Cont.)

Modelo	Años	Código fabricación	Modelo carburador	Kit Carburador	Flotador
350 C.I./B	1979-83	R4	4MV	18-7095	18-7201
350 ④ ③	1988-89	R4	4MV	18-7095	18-7201
350 ②	1988	R2	2GE	18-7086	18-7200
351 CID/5.8L H.O.	—	H4	4010, R50483A, R84046A (F1JL-9510-EA)	18-7727	—
351 CID/5.8L	—	H4	4160, R9393A, R9394A, R50399A, R50399-1A	18-7729	—
351 CID/5.8L	—	H4	4160C, R80434A	18-7730	—
454 C.I./B	1977-78	R4	4MV	18-7072	18-7201
454,454 H.O. ①	1991-92	H4	4150	18-7242	N/D
454,454 H.O. ②	1990-92	H4	4150	18-7241	N/D
460 C.I.	1987-88	H4	4160	18-7017	—
460	1989-90	H4	4160	18-7235	N/D

- ② Para carburadores 2V
- ③ Para carburadores 4V
- ④ Para modelo motor 574APEP-

- WS
- ⑥ Para 1990 PWC sólo sufijo

- ⑨ Para modelo motor 574APERGD
- ① Para modelo motor 744DPEAMH, 744DPPAMH
- ② Para modelo motor 744CPEAMH, 824BPEAM

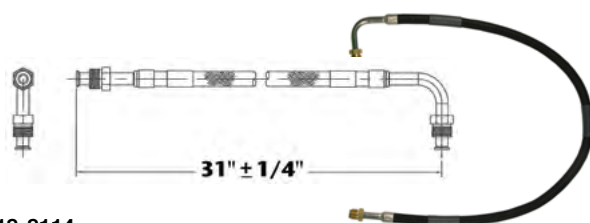

18-8114
LÍNEA COMBUSTIBLE

De la bomba de combustible al carburador. Reemplaza tubo 3/8" X 31" PTFE manguera con hembra 5/8"-18 un final, 5/8"-18 90° un final. SAE J1527 tipo A1

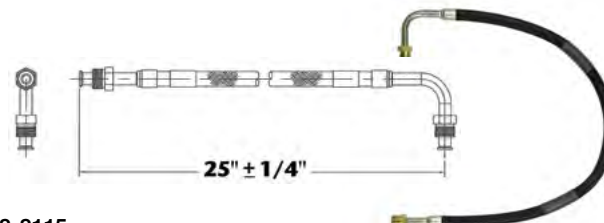

18-8115
LÍNEA COMBUSTIBLE

De la bomba combustible al carburador. Reemplaza tubo 3/8" X 25" PTFE manguera con hembra 5/8"-18 un final, 5/8"-18 90° un final. SAE J1527 tipo A1

TODAS LAS BOMBAS DE COMBUSTIBLE INCLUYEN JUNTA DE MONTAJE



18-7229
ANTI-DEFLAGRANTE
Reemplaza: 986865, 981566



18-7258
BOMBA COMBUSTIBLE
Reemplaza: 380986 Pestaña I.D. #40001, M643
Para: GM (V-6) 225,PB-V215



18-7256
BOMBA COMBUSTIBLE
Pestaña I.D. # 6790
Para: GM (4 & 6 cil.)153, 230, 250, 292



18-7265
BOMBA COMBUSTIBLE
Pestaña I.D. # 41412, M73018
Para: GM (V-8) 305, 350, 400



18-7267
BOMBA COMBUSTIBLE
Reemplaza: 982063
Pestaña I.D. # 40778, M73016 (Incluye junta)
Para Ford (V-8) 302



18-7268
BOMBA COMBUSTIBLE
Reemplaza: 981650
Pestaña I.D. #41415
Para: GM (V-8) 305, 307, 350, 400
Se requiere diafragma dual con vaso.



18-7278
BOMBA COMBUSTIBLE
Reemplaza: 985602, 985603, 982240
Pestaña I.D. #M60032
Usar filtro 18-7860
Para: GM (4 & 6 cil.) 153, 181, 250, 224, 225



18-7289
BOMBA COMBUSTIBLE
Reemplaza: 982997
Pestaña I.D. # 60201 (Incluye junta)
Para: GM (V-6) 262/4.36

APLICACIONES EMPIEZAN EN LA SIGUIENTE PÁGINA



18-7326
BOMBA ELÉCTRICA DE COMBUSTIBLE
 Reemplaza: 3858261, 3857986,
 3850809, 3854620



18-7330
BOMBA ELÉCTRICA DE COMBUSTIBLE
 Reemplaza: 3857650, 3855958, 3854280,
 987620, 988037



18-7331
BOMBA ELÉCTRICA DE COMBUSTIBLE
 Reemplaza: 3850810

APLICACIÓN BOMBA COMBUSTIBLE

Modelo	Años	Bomba #	Modelo	Años	Bomba #
2.5	1982-85	18-7278	185	1978-80	18-7268
5	1982-88	18-7268	190	1974-77	—
5.7	1982-92	18-7268	200	1979-81	18-7268
100	1972-73	18-7278	225	1978	18-7268
110	1964	18-7278	230	1979-81	18-7268
120	1965-80	18-7278	235	1975-77	—
140	1973-81	18-7278	240	1978	—
140 Jet Drive	1973	18-7278	245 Jet Drive	1973	18-7278
150	1964	—	250	1979	—
150 Modelo HU-13EM	1965	—	260	1979-81	18-7268
150 Excepto HU-13EM	1965	—	305 CID IB	1979-82	18-7268
165	1972-76	18-7278	350 CID IB	1979-82	18-7268
170	1974	—	350	1988-91	18-7268
175	1975-77	—			

APLICACIÓN BOMBA ELÉCTRICAS DE COMBUSTIBLE

Año	Motor	Aplicación	OE #	Nº referencia reemplaza	Ref #
1992-94	262/4.3L	Baja presión	3858261	3850809,3850810,3857985	18-7326
1997-98	350/5.7L, 454/7.4L, & 502/8.2L	Motores con MPI - Alta presión	3857650		18-7330
1996	454/7.4L & 502/8.2L	Motores con MPI - Alta presión	3857650		18-7330
1993-94	4.3L hasta 5.8L	Bomba de baja presión	3858261	3850809	18-7326
1992-1994	454/7.4L & 502/8.2L	GM Mark V motor. - baja presión	3858714	3850810, 3857985	18-7331

- DISEÑO UNIVERSAL -

SOPORTE FILTRO GASOLINA



Tipo soporte	Ref #	Tipo soporte	Ref #
1/4" Acero inoxidable	18-7777	1/4" Aluminio	18-7853-1
3/8" Acero inoxidable	18-7776	3/8" Aluminio	18-7775

KITS SEPARADOR AGUA/COMBUSTIBLE



KIT DE FILTROS DE 21 MICRONES PARA MOTORES CARBURACIÓN

Tipo de kit	Ref #	Capacidad de filtrado	Contenido
1/4" Aluminio (Filtro corto)	18-7848-1 1878481E	21	1 - 18-7844 filtro & 1 18-7853-1 soporte 2 - 18-4256 1/4" tapones
1/4" Aluminio bonus pack Contiene filtro de repuesto	18-7848-2	21	2 - 18-7844 filtro & 1 18-7853-1 soporte 2 - 18-4256 1/4" tapones
1/4" Aluminio (Filtro alto)	18-7852-1	21	1 - 18-7845 filtro & 1 18-7853-1 soporte 2 - 18-4256 1/4" tapones
1/4" Aluminio bonus pack Contiene filtro de repuesto	18-7852-2	21	2 - 18-7845 filtro & 1 18-7853-1 soporte 2 - 18-4256 1/4" tapones
3/8" Aluminio (Filtro alto)	18-7775-1	21	1 - 18-7845 filtro & 1 18-7775 soporte 2 - 18-4264 3/8" tapones
1/4" Acero inox (Filtro alto)	18-7777-1	21	1 - 18-7845 filtro & 1 18-7777 soporte 2 - 18-4256 1/4" tapones
3/8" Acero inox (Filtro alto)	18-7776-1	21	1 - 18-7845 filtro & 1 18-7776 soporte 2 - 18-4264 3/8" tapones



KIT FILTROS 10 MICRONES PARA MOTORES DE INYECCIÓN

Kit Tipo	Ref #	Capacidad de filtrado	Contiene
1/4" Aluminio (Filtro alto)	18-7983-1	10	1 - 18-7944 filtro & 1 18-7853-1 soporte 2 - 18-4256 1/4" tapones
1/4" Aluminio bonus pack Contiene filtro de repuesto	18-7983-2	10	2 - 18-7944 filtro & 1 18-7853-1 soporte 2 - 18-4256 1/4" tapones
1/4" Aluminio (Filtro alto)	18-7982-1	10	1 - 18-7945 filtro & 1 18-7853-1 soporte 2 - 18-4256 1/4" tapones
1/4" Aluminio bonus pack Contiene filtro de repuesto	18-7982-2	10	2 - 18-7945 filtro & 1 18-7853-1 soporte 2 - 18-4256 1/4" tapones
1/4" Aluminio (Filtro alta capacidad)	18-7966-1	10	1 - 18-7866 filtro & 1 18-7853-1 soporte 2 - 18-4256 1/4" tapones
3/8" Aluminio (Filtro alto)	18-7986-1	10	1 - 18-7945 filtro & 1 18-7775 soporte 2 - 18-4264 3/8" tapones
1/4" Acero inoxidable (Filtro alto)	18-7984-1	10	1 - 18-7945 filtro & 1 18-7777 soporte 2 - 18-4256 1/4" tapones
3/8" Acero inoxidable (Filtro alto)	18-7985-1	10	1 - 18-7945 filtro & 1 18-7776 soporte 2 - 18-4264 3/8" tapones



KIT FILTROS 10 MICRONES CON VASO DECANTADOR

El vaso transparente Sierra AquaVue™ se usa para fueraborda e instalaciones en cubierta. El vaso metálico AquaVue™ antiinflamable se usa para instalaciones bajo cubierta. Los filtros con vaso decantador transparente o metálico permiten drenar el agua, alargando la vida útil del elemento.

Tipo kit	Ref #	capacidad de filtrado	Contenido
1/4" Aluminio con cazoleta metálica	18-7951	10	1 - 18-7919 filtro & 1 18-7853-1 soporte 1 - 18-7924 cazoleta metálica 2 - 18-4256 1/4" tapones
1/4" Acero inox con cazoleta metálica	18-7938	10	1 - 18-7919 filtro & 1 18-7777 soporte 1 - 18-7924 cazoleta metálica 2 - 18-4256 1/4" tapones

**SOPORTE COMPACTO Y KIT SEPARADOR- PARA PEQUEÑOS INTRABORDA Y FUERABORDA
Y APLICACIONES EN AGUA DULCE**

18-7774
SOPORTE ALUMINIO COMPACTO



18-7965-1
10 MICRONES COMPACTOS
KIT SEPARADOR
Contiene:
1 - 18-7774 soporte
1 - 18-7865 filtro



FILTROS DE REPUESTO



DISEÑO UNIVERSAL

FILTROS DE REPUESTO 10 MICRONES			FILTROS DE REPUESTO 21 MICRONES	
Ref #	Descripción		Ref #	Descripción
18-7944	Corto - 3.875"		18-7844	Corto- 3.875"
18-7945 / 187945E	Largo - 4.35"		18-7845	Largo - 4.35"
18-7866	Alta capacidad - 6"			
18-7865	10 micrones compacto			

FILTROS DE REPUESTO PARA OMC

FILTROS DE REPUESTO 10 MICRONES			FILTROS DE REPUESTO 21 MICRONES		
Ref #	Descripción	Reemplaza	Ref #	Descripción	Reemplaza
18-7946	Rosca OMC	OMC 502905	18-7846	Rosca OMC	OMC 502905
18-7989	Cobra EFI	OMC 502906	18-7789	Cobra EFI	OMC 502906



FILTROS DE REPUESTO 10 MICRONES Y CON VASO DECANTADOR

FILTROS DE REPUESTO			FILTROS DE REPUESTO		
Ref #	Descripción	Reemplaza	Ref #	Descripción	
18-7919	Elemento filtrante	Racor S3213	18-7929	Filtro & Cazoleta metálica	
18-7920	Elemento filtrante	OMC 771839 Racor S3214		Contiene: 18-7919 filtro, 18-7924 cazoleta	
18-7947	Elemento filtrante Para - 120RRAC01	Racor S3240	18-7941-1	Filtro & AquaVue™ cazoleta estilo OMC	
18-7948 187948E	Elemento filtrante Para - 320RRAC01	Racor S3227		Contiene: 18-7920 filtro, 18-7922-1 cazoleta	
18-7949	Spin on replacement Para - 660RRAC02	Racor S3232	18-7943	Filtro & vaso metálico estilo OMC	
				Contiene: 18-7920 filtro, 18-7924 cazoleta	
REPUESTO VASOS DECANTADORES			ELEMENTOS REPUESTO		
Ref #	Descripción		Ref #	Descripción	Reemplaza
18-7924	Vaso metálico		18-7930	1977-83 Sistema combustible	OMC 173326



18-7792
FILTRO COMBUSTIBLE
Reemplaza: 910641, 3855104
Para: OMC 3.0L (1996-98), 3.8L/170 (1981)



18-7854
FILTRO COMBUSTIBLE
Reemplaza: 984491, 311684
Rochester 17078904



18-7855
FILTRO COMBUSTIBLE
Reemplaza: 983870, 910139
Rochester 17068453



18-7717
FILTRO ELEMENTO
Para: Rochester 2 cuerpos & 4 cuerpos Carb.



18-7859
FILTRO COMBUSTIBLE
Reemplaza: 908034
Para: mayoría de GM Inline 4 & 6 cilindros en línea: Ford y GM V-8's hasta 400 HP



18-7860
FILTRO COMBUSTIBLE
Reemplaza: 381690, 312456
Con bomba combustible AC
Para: motores 4 & 6 cilindros en línea



18-7861
RECAMBIO DE CESTO Y FILTRO
Reemplaza: 981911



18-7862
RECAMBIO
Para filtro combustible
(Incluye junta)
Reemplaza: 982230



18-7964
KIT FILTRO TRANSMISIÓN



18-8072
CODO DEPÓSITO
 $\frac{3}{8}$ " Manguera con rosca
 $\frac{3}{8}$ " Rosca NPT
Reemplaza: 174177
90°



RACOR
Rosca NPT
18-8074 **18-8055**
 $\frac{3}{8}$ " con $\frac{1}{4}$ " $\frac{5}{16}$ " con $\frac{1}{4}$ "
Reemplaza: 173312 Reemplaza: 173311

Pack de 10

ABRAZADERAS

Ref.	O.E.	Rango	tam
18-8020 ①	322652	.538 - .608	8
18-8021 ①	911616	.597 - .665	10
18-8034 ①	329654	.670 - .780	12
18-8200 ①	322653	.360 - .406	2
18-8201 ①	124249	.410 - .468	4
18-8202 ①	322654	.475 - .536	6
18-8203 ①	329653	.750 - .875	14
18-8204 ①	324825	.875 - .975	19



18-5894
INTERRUPTOR PRESIÓN ACEITE
Reemplaza: 0379948

APLICACIÓN BOMBAS CIRCULACIÓN AGUA



18-3575
BOMBA DE CIRCULACIÓN AGUA
Reemplaza: 984360, 986779, 380640, 3854017, 3858340
Usar junta 18-0327 (Incluye)
Para: GM En línea (4 & 6 Cilindros)



18-3578
BOMBA DE CIRCULACIÓN AGUA
Reemplaza: 984876



18-3577-1
BOMBA DE CIRCULACIÓN AGUA
Reemplaza: GM 6269358, OMC 987447, 983296, 986074, 3854118
Para: Bloque grande GM



18-3584
BOMBA DE CIRCULACIÓN AGUA
Reemplaza: 982517, 3853796, 982515
Usar junta 18-0147 (Incluye). Para: Ford V8 bloque pequeño



18-3599
BOMBA DE CIRCULACIÓN AGUA
Reemplaza: 382218, 980477, 985429, 3853850
Para: GM V-6 & bloques pequeños motor V-8. Usar junta 18-0981 (incluye)

① Precio por pieza. Para pedir precio por pack, añadir -9 a la referencia.

APLICACIÓN BOMBA CIRCULACIÓN AGUA

Modelo	Año	Ref #	Modelo	Año	Ref #	Modelo	Año	Ref #
2.3	1987-90	-	165	1972-76	18-3575	245	1972-75	18-3599-1
2.5	1982-86	18-3575	175	1977	18-3584	245		
3	1982-92	18-3575	185	1967-80	18-3599-1	Jet Drive	1972-75	18-3599-1
3.8	1981-86	18-3599-1	190	1977	18-3584	250		
4.3	1985-92	18-3599-1	200	1979-81	18-3599-1	Intraborda	1970-74	18-3599-1
5	1982-88	18-3599-1	210	1968-70	18-3599-1	250	1979	18-3575
5	1989-92	18-3575	210			260		
5.7	1982-92	18-3599-1	Intraborda	1970-72	18-3599-1	Intraborda	1975-76	18-3599-1
5.8	1989-92	18-3575	215	1971	18-3599-1	260	1979-81	18-3599-1
100	1972	18-3575	225	1972-78	18-3599-1	262	1989	18-3599-1
100	1973	18-3599-1	225			290		
120	1965-69	18-3575	Intraborda	1973-74	18-3599-1	Jet Drive	1974-75	18-3599-1
120	1972	18-3575	230			305 CID IB	1977-82	18-3599-1
120	1973-74	18-3599-1	Intraborda	1975-76	18-3599-1	350 CID IB	1977-82	18-3599-1
120	1975-81	18-3575	230	1979-81	18-3599-1	350	1988-92	18-3599-1
140			235	1971	18-3599-1	351	1992	18-3584
Jet Drive	1973	18-3575	235	1977	18-3584	454 CID IB	1977-80	18-3577-1
140	1973-81	18-3575	240	1978	18-3584	454 CID IB	1982	18-3599-1

18-3058 CEF
18-3058S
IMPULSOR
 Reemplaza: 983895



18-3086
IMPULSOR
 Reemplaza: 379475, 777130



18-30585
IMPULSOR
 Reemplaza: 3854072
 Para: King Cobra (1992-1995)



APLICACIÓN IMPULSORES

Modelo	Años	Impulsor	Modelo	Años	Impulsor
2.3	1987-1990	18-3058 ①	170	1974	18-3086
2.5	1986	18-3058	175	1975-1977	18-3086
3	1986-1992	18-3058 ①	185	1967-1968	18-3086
4.3	1986-1992	18-3058	185	1978-1984	18-3086
5	1986-1992	18-3058	190	1974-1977	18-3086
5.7	1986-1992	18-3058 ②	200	1966-1968	18-3086
5.8	1989-1992	18-3058	200	1979-1984	18-3086
50FAPLJVB, 50FAPJVN	1993	18-3058	210	1968-1972	18-3086
50FAPRJVB	1993	18-3058	215	1971	18-3086
50FACPMDA, 50FACPMDM	1994	18-3060	225	1972-1976	18-3086
50FAGPMDA, 50FAGPMDM	1994	18-3060	225	1978	18-3086
50FAGPMDM	1994	18-3060	230	1975-1976	18-3086
58FACPMDA, 58FACPMDM	1994	18-3060	230	1979-1981	18-3086
58FAGPMDA, 58FAGPMDM	1994	18-3060	232AMFTC	1987	18-3086
58FAPLJVB, 58FAPLJVN	1993	18-3058	232AMRGDE, 232AMRGDP	1988	18-3058
58FAPRJVB, 58APRJVN	1993	18-3058	232APFTC	1987	18-3058
7.5	1987	18-3058	232APRGDE, 232APRGDP	1988	18-3058
80	1968-1969	—	232APSRC	1987	18-3058
88	1964	—	232BMRMED, 232BMRMEF	1989	18-3058
90	1965-1968	—	232BPRMED, 232BPRMEF	1989	18-3058
90	1970-1971	—	235	1971	18-3088
100	1972-1973	18-3086	235	1975-1977	18-3088
110	1964	— ③	240	1978	18-3088
110	1964	18-3086 ④	245	1972-1975	18-3086
120	1965-1967	— ③	250	1970-1974	18-3086
120	1965-1967	18-3086 ④	250	1979	18-3086
120	1968-1984	18-3086	252AMKWB, 252APKWB	1986	18-3058
140	1973-1984	18-3086	260	1975-1976	18-3086
150	1964-1966	18-3086	260	1979-1984	18-3086
155	1967-1972	18-3086	262	1989	18-3058
165	1972-1976	18-3086	262AMLMED, 262APRMED	1989	18-3058

① Excepto modelos originalmente equipados con impulsor corto o re-equipados con kit impulsor corto

② Excepto modelos 1992 5.7LE ③ Bomba estándar ④ Bomba Heavy duty

Modelo	Años	Impulsor	Modelo	Años	Impulsor
302AMARJ, 302AMARY	1987	18-3058	434AMKWB	1986	18-3058
302AMFTC	1987	18-3058	434AMPLWS	1990	18-3058
302AMKWB	1986	18-3058	434AMWXS	1986	18-3058
302AMRGDP	1988	18-3058	434AMLGDP	1988	18-3058
302AMRMED	1989	18-3058	434APARY, 434APFTC	1987	18-3058
302APARY, 302APFTC	1987	18-3058	434APKWB	1986	18-3058
302APKWB	1986	18-3058	434APLAMH	1992	18-3058
302APRGDP	1988	18-3058	434APLJVB, 434APLJVN	1993	18-3058
302APRMED	1989	18-3058	434APLRGD	1991	18-3058
302APSRC, 302ARSRY	1987	18-3058	434APRAMH	1992	18-3058
302BMRAMH, 302BMRAMK	1992	18-3058	434APRGDP	1988	18-3058
302BMRJVB	1993	18-3058	434APRJVB, 434APRJVN	1993	18-3058
302BMRRGD	1991	18-3058	434APRPWS	1990	18-3058
302CCPMDA, 302CGPMDA	1994	18-3060	434APRRGD	1991	18-3058
302CMHUB	1995	18-3060	434APSRC, 434APSRV	1987	18-3058
302CMNCA, 302CMNCS	1996	18-3060	434APWXS	1986	18-3058
302CMRAMH, 302CMRRAMK	1992	18-3058	454	1977	18-3086
302CMRJVB	1993	18-3058	454	1990-1991	18-3058
302CMRRGD	1991	18-3058	460	1988-1990	18-3058
302CPHUB	1995	18-3060	460AMLMED	1989	18-3058
302CPNCA "A" SUFFIX MODELS	1996	18-3060	460APRMED	1989	18-3058
302CPNCS "A" SUFFIX MODELS	1996	18-3060	502ACPMDA	1994	18-3060
302CPRAMH, 302CPRAMK	1992	18-3058	502AGPMDA	1994	18-3060
302CPRJVB	1993	18-3058	502AMLGDP	1988	18-3058
302CPRRGD	1991	18-3058	502AMLMED	1989	18-3058
302DCMMDA, 302DGMMDA	1994	18-3060	502AMPLPWS, 502ANLPWS	1990	18-3058
305	1977-1978	18-3086	502APLAMH, 502APLAMK	1992	18-3058
350	1977-1978	18-3086	502APLJVB	1993	18-3058
350	1988-1991	18-3058	502APLRGD	1991	18-3058
350AMLMED, 350APRMED	1989	18-3058	502APRAMH, 502APRAMK	1992	18-3058
370	1988	18-3058	502APRGDP	1988	18-3058
432ACMMDA, 432ACPMDA	1994	18-3060	502APRJVB	1993	18-3058
432AGMMDA, 432AGPMDA	1994	18-3060	502APRMED	1989	18-3058
432AMARY, 432AMFTC	1987	18-3058	502APRPWS	1990	18-3058
432AMKWB	1986	18-3058	502APRRGD	1991	18-3058
432AMLGDP	1988	18-3058	502BPRAMH, 502BPRAMK	1992	18-3058
432AMLMED	1989	18-3058	502BPRJVB	1993	18-3058
432AMPLPWS	1990	18-3058	502BPRMED	1989	18-3058
432AMWXS	1986	18-3058	502BPRPWS	1990	18-3058
432APARY, 432APFTC	1987	18-3058	502BPRRGD	1991	18-3058
432APKWB	1986	18-3058	504AMARY, 504AMFTC	1987	18-3058
432APLAMH	1992	18-3058	504AMKWB	1986	18-3058
432APLJVB, 432APLJVN	1993	18-3058	504AMLGDP	1988	18-3058
432APLRGD	1991	18-3058	504AMWXS	1986	18-3058
432APRAMH	1992	18-3058	504APARY, 504APFTC	1987	18-3058
432APRGDE, 432APRGDP	1988	18-3058	504APKWB	1986	18-3058
432APRJVB, 432APRJVN	1993	18-3058	504APRGDP	1988	18-3058
432APRMED	1989	18-3058	504APWXS	1986	18-3058
432APRPWS	1990	18-3058	572ACPMDA, 572AGPMDA	1994	18-3060
432APRRGD	1991	18-3058	574AMFTC	1987	18-3058
432APSRC, 432APSRV	1987	18-3058	574AMKWB	1986	18-3058
432APWXS	1986	18-3058	574AMLGDP	1988	18-3058
434AMARY, 434AMFTC	1987	18-3058	574AMLMED	1989	18-3058

① Excepto modelos originalmente equipados con impulsor corto o re-equipados con kit impulsor corto

② Excepto modelos 1992 5.7LE ③ Bomba estándar ④ Bomba Heavy duty

Modelo	Años	Impulsor	Modelo	Años	Impulsor
574AML PWS	1990	18-3058	584AML MED	1989	18-3058
574AMWXS	1986	18-3058	584AML PWS	1990	18-3058
574APARY	1987	18-3058	584APL AMH, 584APL AMK	1992	18-3058
574APEPWS	1990	18-3058	584APL JVB	1993	18-3058
574APERGD	1991	18-3058	584APL RGD	1991	18-3058
574APFTC	1987	18-3058	584APR AMH, 584APR AMK	1992	18-3058
574APKWB	1986	18-3058	584APR JVB	1993	18-3058
574APL AMH	1992	18-3058	584APR MED	1989	18-3058
574APL RGD	1991	18-3058	584APR PWS	1990	18-3058
574APR AMH	1992	18-3058	584APR RGD	1991	18-3058
574APR GDP	1988	18-3058	744APEPWS	1990	18-3058
574APR MED	1989	18-3058	744APERGD, 744APERGF	1991	18-3058
574APR PWS	1990	18-3058	744BPERGD	1991	18-3058
574APR RGD	1991	18-3058	754APEPWS	1990	18-3058
574AP SRC	1987	18-3058	754APFTC, 754AP SRC	1987	18-3058
574APWXS	1986	18-3058	754BPFTC, 754BP SRC	1987	18-3058
574BML GDP	1988	18-3058			
574BPEPWS	1990	18-3058			
574BPERGD	1991	18-3058			
574BPR GDP	1988	18-3058			
584ACPMDA, 584AGPMDA	1994	18-3060			

- ① Excepto modelos originalmente equipados con impulsor corto o re-equipados con kit impulsor corto
- ② Excepto modelos 1992 5.7LE models
- ③ Bomba estándar
- ④ Bomba Heavy duty



18-3108
LLAVE IMPULSOR
 Reemplaza: 308928
 Para: Modelo colas (1968-85)
 Para: Impulsores stringer drive 18-3086



18-3111
RETÉN EJE BOMBA AGUA
 Reemplaza: 907774
 I/O 1972-86
 EXCEPTO COBRA



18-4833
ALOJAMIENTO PASO DE AGUA (UNIDAD INFERIOR)
 Reemplaza: 915720
 Para: OMC Cobra (1986-93) Sin cono embrague



18-4837
TAPA PASO DE AGUA
 Reemplaza: 911734
 Para: OMC Cobra (1986-93) sin cono de embrague



18-3119
ALOJAMIENTO BOMBA AGUA
 Reemplaza: 983298



18-3206
ALOJAMIENTO BOMBA AGUA
 Reemplaza: 984744
 Para: OMC Cobra



18-3145
CASQUILLO TURBINA
 Reemplaza: 911844



18-3121
PLATINA IMPULSOR
 Reemplaza: 911703
 COBRA



18-3141
PLATINA IMPULSOR
 Reemplaza: 313176
 110-260 HP I/O 1968-86
 EXCEPTO COBRA



18-3502
MANGUERA BOMBA
 Reemplaza: 912614
 Para: OMC Cobra (1986-93) sin cono de embrague

① 18-3212-1D 



18-3212-1
KIT REPARACIÓN IMPULSOR
Reemplaza: 984461

— CONTIENE —

Ref #	Descripción	O.E.M. #	Cant.
18-2541	Aro tórico	911704	1
18-2916	Junta aloj. bomba agua	911702	1
18-3058	Impulsor	983895	1
18-3121	Platina impulsor	911703	1
18-3145	Casquillo impulsor	911844	1



18-3286
KIT REPARACIÓN IMPULSOR
1964-86
EXCEPTO COBRA

— CONTIENE —

Ref #	Descripción	O.E.M. #	Cant.
18-7135	Aro tórico	310584	1
18-3141	Platina	313176	1
18-7129	Aro tórico	314491	1
18-3111	Retén goma	907774	1
18-3086	Impulsor	379475	1
18-7158	Aro tórico	310585, 310967	1



18-3386
KIT BOMBA AGUA
Reemplaza: 983218
1964-86
EXCEPTO COBRA

— CONTIENE —

Ref #	Descripción	O.E.M. #	Cant.
18-7135	Aro tórico	310584	1
18-3141	Platina	313176	1
18-7129	Aro tórico	314491	1
18-3086	Impulsor	379475	1
18-3111	Retén goma	907774	1
18-3119	Alojamiento Impulsor	983298	1
18-7158	Aro tórico	310585, 310967	1



18-3348
KIT COMPLETO BOMBA AGUA
Reemplaza: 984461

Para: Todas colas OMC Cobra-2.3 (1987-90),
2.5 (1986), 3.0(1986-93), 4.3(1986-93), 4.6(1989),
5.0(1986-93), 5.7(1986-93),
5.8 (1989-93), 7.5(1987-89)
Usar impulsor 18-3058



18-3469
KIT REPARACIÓN BOMBA AGUA
Reemplaza: 3854661

Para: Colas King Cobra (1992-1995)



18-3349
KIT ALOJAMIENTO BOMBA AGUA

Para: Todas colas OMC Cobra-2.3 (1987-90),
2.5 (1986), 3.0(1986-93), 4.3(1986-93), 4.6(1989),
5.0(1986-93), 5.7(1986-93),
5.8 (1989-93), 7.5(1987-89)



18-5897
TRANSMISOR DE TEMPERATURA

Reemplaza: 980613
3/8" — 18 NPT
Para: Mercruiser Vazer



18-5898
TRANSMISOR DE TEMPERATURA

Reemplaza: 171960
1/2" — 14 NPT



18-5899
TRANSMISOR PRESIÓN ACEITE

Reemplaza: 982650



18-3554
TERMOSTATO
Reemplaza: 383307
160°



18-3558
TERMOSTATO
Reemplaza: 982554,
3853799
160°

① 18-3653D 



18-3653
KIT TERMOSTATO

— CONTIENE —

Ref #	O.E. #	Desc.
18-3554	383307	Termostato
18-2858	314809	Junta colector
18-2917	3701777 (GM)	Junta termostato
18-0398	3852111	Junta termostato

APLICACIÓN PARA TERMOSTATOS/KITS EN LA SIGUIENTE PÁGINA

① Referencias acabadas en "D" envasadas - Referencia normal no envasada

① **18-3670D** 



**18-3670
KIT TERMOSTATO**
Para: 2.5L & 3.0L (1982-88)
- **CONTIENE** -

Ref #	O.E.#	Desc.
18-3558	982554	Termostato
18-2858	314809	Junta tapa aloj.termostato
18-0929	313416	Junta termostato

① **18-3676D** 



**18-3676
KIT TERMOSTATO**
140°
Para: 7.4L (1994-98), 8.2L (1998)
- **CONTIENE** -

Ref #	O.E.#	Desc.
18-7170	3852071	Aro
18-0398	3852111	Junta termostato
-	3853983	Termostato

① **18-3677D** 



**18-3677
KIT TERMOSTATO**
160°
- **CONTIENE** -

Ref #	O.E.#	Desc.
18-7170	3852071	Aro
18-0398	3852111	Junta termostato
-	3856961	Termostato

HP	Año	HP	Año
4.3L	1994-97	5.8L	1994-97
4.3 HO	1991-97	5.8 (EFI)	1993-97
5.0 L	1994-97		

APLICACIONES TERMOSTATO/KIT TERMOSTATO

Modelo	Años	Termostato	Kit Termostato	Modelo	Años	Termostato	Kit Termostato
90	1970	18-3554	18-3653	250	1970-73	18-3554	18-3653
100	1972-73	18-3554	18-3653	250	1979	18-3554	18-3653
120	1969-80	18-3554	18-3653 ①	260	1979-81	18-3554	18-3653
120	1980-81	18-3558	18-3670 ②	262	1989	18-3554	-
140	1973-80	18-3554	18-3653 ①	305	1977-82	18-3554	18-3653
140	1980-81	18-3558	18-3670 ②	350	1977-82	18-3554	18-3653
155	1969-72	18-3554	18-3653	350	1989	18-3554	-
165	1972-76	18-3554	18-3653	351	1992	18-3554	-
170	1974	18-3554	18-3653	454	1977-82	18-3554	18-3653
175	1975-77	18-3554	18-3653	460	1989	18-3554	-
185	1978-80	18-3554	18-3653	2.5L	1982-88	18-3558	18-3670
190	1974-77	18-3554	18-3653	3.0L	1982-88	18-3558	18-3670
200	1979-81	18-3554	18-3653	3.8L	1981-85	18-3554	18-3653
210	1969-72	18-3554	18-3653	4.3L	1985-86	18-3554	18-3653
215	1971	18-3554	18-3653	4.3L	1989-92	18-3554	-
225	1971	18-3554	18-3653	5.0L	1982-88	18-3554	18-3653
230	1979-81	18-3554	18-3653	5.0L	1989-92	18-3554	-
235	1971	18-3554	18-3653	5.7L	1982-88	18-3554	18-3653
235	1975-77	18-3554	18-3653	5.7L	1989	18-3554	-
240	1978	18-3554	18-3653	5.8L	1989-92	18-3554	-
245	1972-75	18-3554	18-3653	7.5L	1988	18-3554	18-3653

① 1980 Modelos con solo sufijo "C"

② 1980 Modelos con sufijo "C1"

MANGUITOS DIÁMETRO ÚNICO



**18-70021
MANGUITO**
3/4" DI



**18-70704
MANGUITO**
1 1/4" DI



**18-70924
MANGUITO**
1 3/4" DI

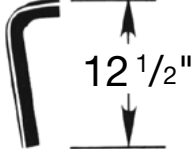

**18-71218
MANGUITO**
1" DI

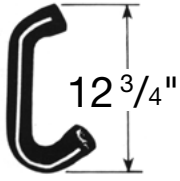

**18-71337
MANGUITO**
1 3/4" DI

MANGUITOS RECTOS



**18-75100
MANGUITO**
Longitud 48"
1" DI



**18-75125
MANGUITO**
Longitud 48"
1 1/4" DI

① Referencias acabadas en "D" envasadas - Referencia normal no envasada

CORREAS

- 1 Cordón sintético de alta resistencia. Sus propiedades aseguran un comportamiento uniforme de toda la correa.
- 2 La sección de compresión es un compuesto de goma que garantiza la suavidad de los impactos que reciben los cordones.
- 3 Dientes moldeados para incrementar la flexibilidad sin dañar el soporte. Gran área de circulación de aire evita el calentamiento y deterioro de la correa.
- 4 Los bordes de goma mantienen una transmisión de energía muy fiable.

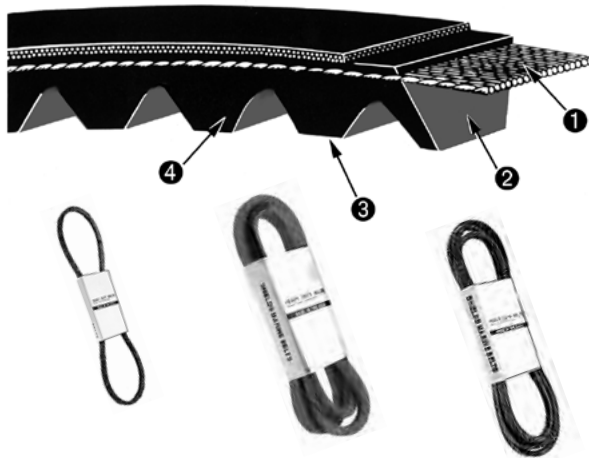

TAMAÑOS DE CORREAS ORDENADAS POR NÚMERO

Ref #	Longitud efectiva (Pulgadas)	Ancho máximo (Pulgadas)	Ref #	Longitud efectiva (Pulgadas)	Ancho máximo (Pulgadas)	Ref #	Longitud efectiva (Pulgadas)	Ancho máximo (Pulgadas)
18-15290	29	29/64	18-15405	40 1/2	29/64	18-15460	46	29/64
18-15300	30	29/64	18-15410	41	29/64	18-15470	47	29/64
18-15325	32 1/2	29/64	18-15415	41 1/2	29/64	18-15480	48	29/64
18-15345	34 1/2	29/64	18-15430	43	29/64	18-15495	49 1/2	29/64
18-15370	37	29/64	18-15435	43 1/2	29/64	18-15500	50	29/64
18-15380	38	29/64	18-15440	44	29/64	18-15520	52	29/64
18-15390	39	29/64	18-15450	45	29/64	18-15550	55	29/64
18-15400	40	29/64	18-15455	45 1/2	29/64			

CORREAS INTERCAMBIO

INTERCAMBIO MANGUITOS

OMC #	Ref #	Ref #	OMC #	Sierra #	Ref #	Sierra #	Ref #
310953	18-15460	18-15380	910414	18-71337	312781	18-75100	913488
311046	18-15440	18-15400	311606	18-75100	910305	18-75125	912793
311606	18-15400	18-15415	910343	18-75100	912424		
908929	18-15455	18-15435	912509				
909818	18-15500	18-15440	311046				
909971	18-15460	18-15450	914787				
910343	18-15415	18-15455	908929				
910414	18-15380	18-15460	310953				
912418	18-15500	18-15460	909971				
912509	18-15435	18-15500	909818				
912714	18-15520	18-15500	912418				
914787	18-15450	18-15520	912714				

APLICACIÓN CORREAS

Modelo	Año	Alternador	Bomba agua	Dirección Asistida	Modelo	Año	Alternador	Bomba agua	Dirección Asistida
100	1972-73	18-15400	18-15400	—	262 KING COBRA	1989	—	*18-15380	18-15455
110	Todos	18-15440	18-15440	—	305	1977-84	18-15440	18-15440/ *18-15455 or *18-15500	—
120	1965-81	18-15400	18-15400	—					
140	1982-87	18-15400	18-15400	—					
165	1972-76	18-15400	18-15400	—	350	1977-84	18-15440	18-15440/ *18-15455 or *18-15500	—
170	1974	18-15400	18-15400	—					
175	1975-77	18-15400	18-15400	—					
185 sin PS	1978-84	18-15440	18-15440	—	350 KING COBRA	1988-90	18-15455	18-15455	—
185 con PS	1978-84	18-15460	18-15460	18-15460	350 KING COBRA	1988-90	18-15470	*18-15380	—
190	1974-77	18-15400	18-15400	—	18-15455				
200 sin PS	1979-81	18-15440	18-15440	—	454	1977-82	18-15455	18-15455/ *18-15500	—
200 con PS	1979-81	18-15460	18-15460	18-15460					
210	1970-71	18-15440	18-15440	—	454 KING COBRA	—	—	18-15470	18-15380
215	1971	18-15440	18-15440	—	460 KING COBRA	1988	18-15460	18-15460	18-15520
225	1972-84	18-15440	18-15440	—	888	—	18-15435	18-15435	—
230,260	1975	18-15440	18-15440/ *18-15455	—	2.3L	1987-90	18-15435	18-15435	18-15435
230,260	1979-81	18-15440	18-15440	—	2.5L sin PS	1982-87	18-15415	18-15415	—
230,260	1979-81	18-15460	18-15460	18-15460	2.5L con PS	1982-87	18-15400	18-15400	18-15460
235	1971	18-15440	18-15440	—	3.8L sin PS	1982-90	18-15400	18-15400	—
235	1975-77	18-15400	18-15400	—	3.8L con PS	1982-90	—	*18-15380	18-15455
240	1978-84	18-15400	18-15400	—	5.0L sin PS	1982-90	18-15455	18-15455	—
250	1979	18-15400	18-15400	—	5.0L con PS	1982-90	—	*18-15380	18-15455
262 KING COBRA	1989	18-15400	18-15400	—	5.0L	1988	18-15400	18-15400	18-15450
					7.5L	1987	18-15460	18-15460	18-15520

* CON BOMBA AGUA MARINA

Fits GM 181 CID 3.0L, 4 Cylinder Fits Most 141 Models

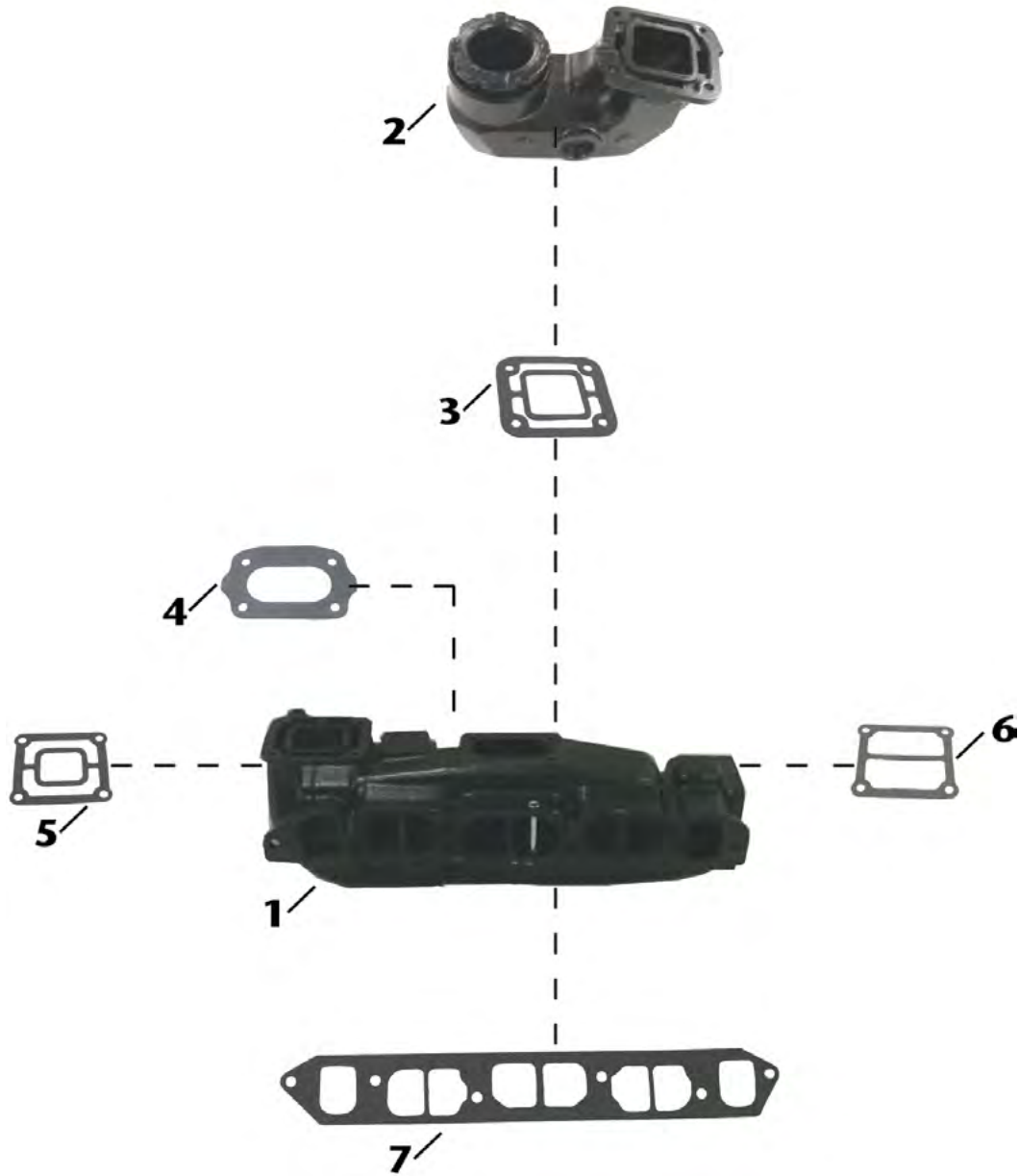

Ref	Descripción	OE No.	Aplicación	
1	18-1901	COLECTOR	982490, 980083, 984054	GM 181 cu.in. 3.0L , 4 Cilindro. Para modelos 140.
2	18-1922	CODO COLECTOR	987784	Usar con colector: 18-1901; Junta codo: 18-2875-1
3	18-2875-1	JUNTA CODO	3850495	Usar con codo: 18-1922
4	18-0937	JUNTA CARBURADOR	315055	Usar con colector: 18-1901
5	18-2861-1	JUNTA TAPA	311121	Usar con colector: 18-1901
6	18-0114	JUNTA TAPA LATERAL	907761	Usar con colector: 18-1901
7	18-1204-1	JUNTA COLECTOR	912164	Usar con colector: 18-1901

Fits GM Small Block V8 305-350 cu. in. 1979-1989

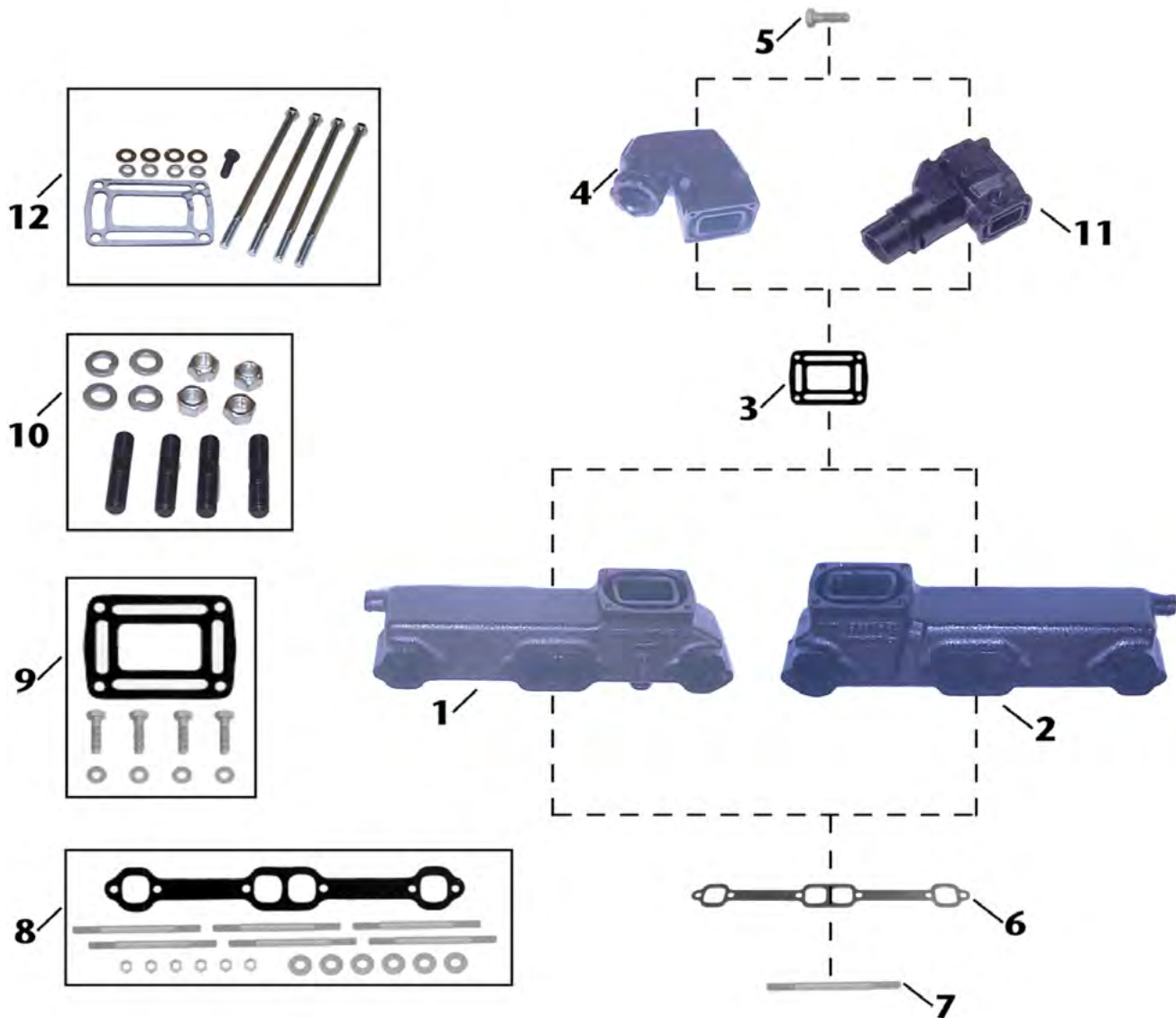

Ref	Descripción	OE No.	Aplicación	
1	18-1902	COLECTOR (ESTRIBOR)	912441	GM Bloque pequeño (V8) 305-350 cu.in. (1979-1989)(Estribor) Usar con junta colector: 18-2949. Kit montaje: 18-8502
2	18-1903	COLECTOR (BABOR)	912442	GM Bloque pequeño (V8) 305-350 cu.in. (1979-1989)(Babor). Usar con Junta colector: 18-2949. Kit de montaje: 18-8502
3	—	JUNTA CODO	909786	Usar con codo: 18-1921; Kit de montaje: 18-8534.
4	18-1921	CODO COLECTOR	909863	Usar con colector: 18-1902, 18-1903. Kit montaje: 18-8534.
5	NSI	PERNO DE MONTAJE	N/D	Incluido en Kit de montaje 18-8534.
6	18-2949	JUNTA COLECTOR	96306	Usar con colector: 18-1902, 18-1903. Incluye en 18-8502 Kit montaje.
7	NSS	ESPARRAGOS DE MONTAJE	N/D	Incluido en el kit de montaje 18-8502.
8	18-8502	KIT DE MONTAJE	N/D	Usar con colector: 18-1902, 18-1903. Incluye junta colector 18-2949.
9	18-8534	KIT DE MONTAJE	N/D	Usar con codo: 18-1921.
10	18-8553	KIT TORNILLERÍA	N/D	Tornillería sólo para codo 18-1921.
11	18-1909 18-1909S	CODO COLECTOR	N/D	Usar con junta codo: 18-0943-2
12	18-8507	KIT MONTAJE	N/D	Usar con codo colector: 18-1909

NSS= NO SE VENDE POR SEPARADO
NSI= NO SE VENDE INDIVIDUALMENTE

Fits GM Small Block V8 305-350 cu. in.

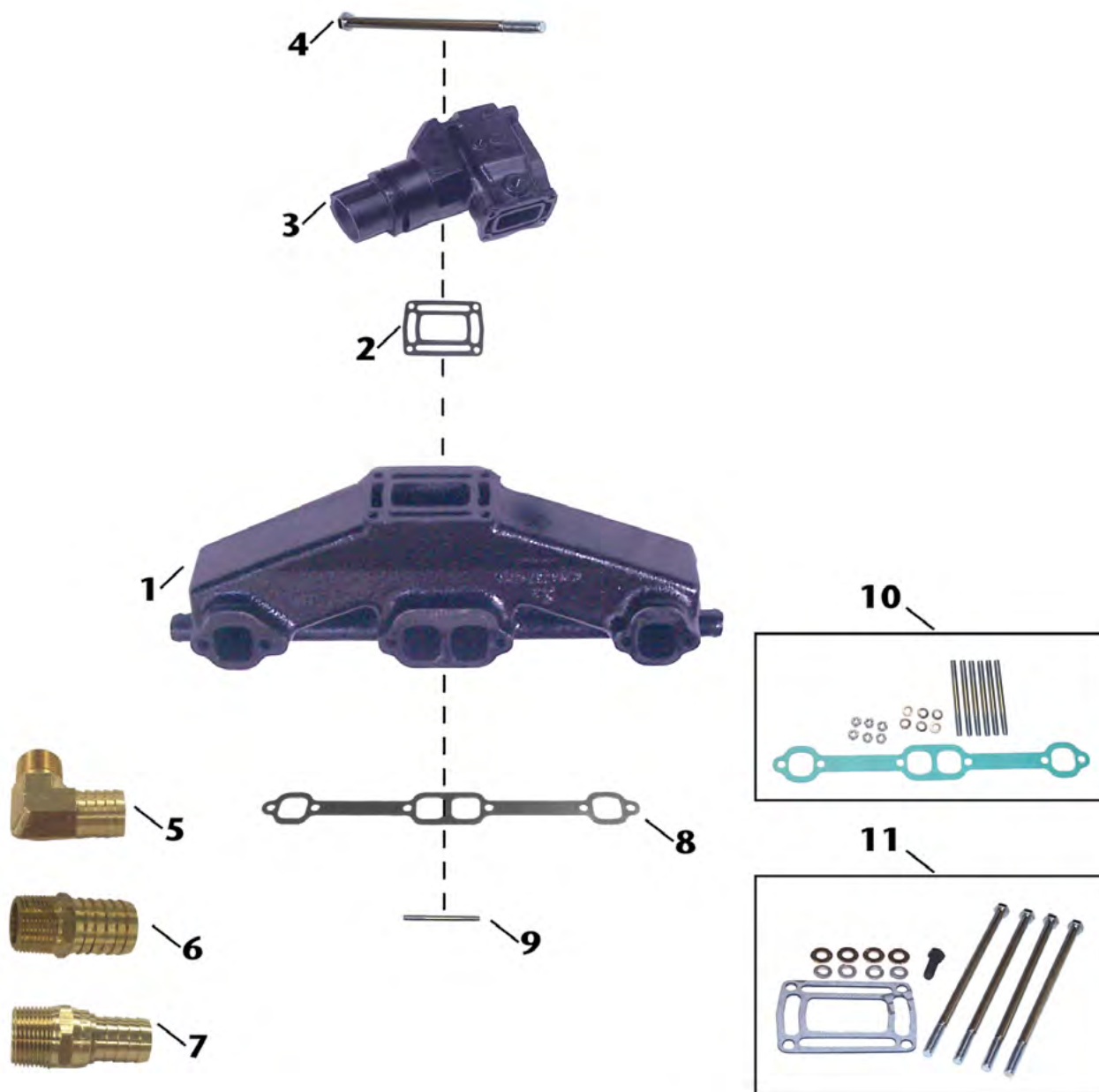

Ref	Descripción	OE No.	Aplicación
1	18-1986S 18-1986 COLECTOR	3857723	GM Bloque pequeño (V8) 305-350 cu.in. Usar con junta colector: 18-2949; Kit montaje: 18-8502.
2	— JUNTA CODO	909786	Usar con codo: 18-1909-1. Incluido en el kit de montaje 18-8507.
3	18-1909S 18-1909 CODO COLECTOR	913784, 3855270, 3850459, 3857944	Usar con colector: 18-1986-1; kit de montaje: 18-8507.
4	NSI PERNO DE MONTAJE	N/D	Incluido en el kit de montaje 18-8507.
5	18-8216 ENTRONQUE	N/D	1/2" - 14NPT X 3/4" Manguera (Conector resistente a la corrosión)
6	18-4461 ENTRONQUE	N/D	3/4" - 14NPT X 1" Manguera (Conector resistente a la corrosión)
7	18-8215 ENTRONQUE	N/D	3/4" - 14NPT X 3/4" Manguera (Conector resistente a la corrosión)
8	18-2949 JUNTA COLECTOR	96306	Usar con colector: 18-1986-1. Incluido en 18-8502
9	NSS ESPARRAGOS DE MONTAJE	N/D	Incluido en kit de montaje 18-8502.
10	18-8502 KIT DE MONTAJE	N/D	Usar con colector 18-1986-1. Incluye junta colector 18-2949.
11	18-8507 KIT DE MONTAJE	N/D	Usar con codo: 18-1909-1. Incluye junta codo 18-0943-2.

NSS= NO SE VENDE POR SEPARADO
NSI= NO SE VENDE INDIVIDUALMENTE

COLECTORES SIERRA

ESTÁN PINTADOS Y PROBADOS CONTRA FUGAS



18-1901
COLECTOR
 Reemplaza: 984054
 Para 181 CID modelo 140
 y 3.0L (1973 - 1989)
 Usar con: Junta codo escape 18-1204-1 & junta
 codo 18-2875-1
 *Para despiece - Mirar página 234



18-1898
COLECTOR
 Babor & estribor
 Reemplaza: Barr CHVA-1-84, Marine Power 0991-110
 Para motores V8 454 cu.in. GM bloque grande
 Usar con:
 Junta colector escape: 18-0418



18-1997S
COLECTOR ESCAPE
 Babor & estribor
 Reemplaza Barr CHV-1-83 Colector universal codo centrado
 Para: motores GM 283, 305, 307 y 350 CID
 Usar con:
 Juego juntas colector escape: 18-0604

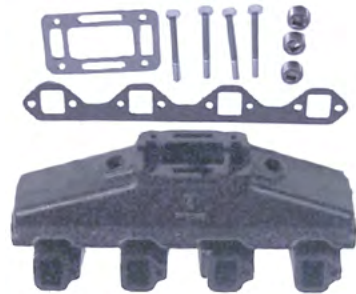

18-1998 HGE
18-1998S
COLECTOR ESCAPE
 Babor & Estribor
 Reemplaza: Barr FM-1-83
 Colector universal codo centrado
 Para: Motores Ford 302 y 351 CID
 Usar con:
 Juego junta colector escape: 18-0603



18-1986 HGE
18-1986S
COLECTOR
 Babor & Estribor
 Reemplaza: 3852374, 3857723
 Para: GM bloque pequeño V8 305-350 ci
 Usar con:
 Junta colector escape: 18-2949
 Kit de montaje: 18-8502



18-1902
COLECTOR
 Reemplaza: 912441
 V-8 - ESTRIBOR
 Para mayoría de bloques pequeños GM V-8 con salida extremo
 Usar con:
 Kit de montaje: 18-8502



18-1903
COLECTOR
 Reemplaza: 912442 V-8 - PORT SIDE
 Para mayoría de bloques pequeños GM V-8 con salida extremo
 Usar con:
 Kit de montaje: 18-8502







18-1904
COLECTOR
 Babor y estribor
 Reemplaza: 980959 V-8 - AMBOS LADOS
 Para mayoría de Ford V-8 302 y 351W con salida extremo
 Usar con:
 Junta colector escape: 18-0183-1 or 18-2896-1
 (Ver tabla de aplicaciones)

 <p>18-1876 CODO Reemplaza: 980617 Usar con: Colector: 18-1904 Junta codo: 18-2850 Para: 170 (1974), 175 (1975-76), 190 (1974-76), 235 (1975-76)</p>	 <p>18-1991 30°ADAPTADOR CODO ESCAPE Para usar con 3" D.I. Manguera escape Usar con: Codo colector: 18-1999</p>	 <p>18-1992-1 80° CODO ESCAPE Para manguera escape 3" D.I. (Como usado en el kit conversión colector de escape 18-1987)</p>
---------------------------------------------------------------------------------------------------------------------------------------------------------------------------------------------------------------------------------------------------------------------------------------------------------------------------------------------------------------------------------------	---------------------------------------------------------------------------------------------------------------------------------------------------------------------------------------------------------------------------------------------------------------------------------------------------------	----------------------------------------------------------------------------------------------------------------------------------------------------------------------------------------------------------------------------------------------------------------------------

 <p>18-1921 CODO COLECTOR Reemplaza: 909863 V-8 Para mayoría de bloques pequeños GM V-8 Usar con: Colector: 18-1902, 18-1903 Junta codo: 18-0943-2 Kit de montaje: 18-8534</p>	 <p>18-1922 COLECTOR CODO Reemplaza: 987784 4 CIL. Para mayoría 140 HP 3.0L (181 CID) Usar con: Colector: 18-1901 Junta codo: 18-2875-1</p>
---------------------------------------------------------------------------------------------------------------------------------------------------------------------------------------------------------------------------------------------------------------------------------------------------------------------------------------------------------------------------------------------------------------------------------------	---------------------------------------------------------------------------------------------------------------------------------------------------------------------------------------------------------------------------------------------------------------------------------------------------------------------------------------------------------------------------------

 <p>18-1909 HGE 18-1909S HGE CODO Reemplaza: OMC 913784, 3855270, 3850456, 3857944 VOLVO 3855270-9, 3857944-7, 3863061 OMC codo, 4" salida 7°: Para mayoría de colectores GM & Ford. Usar con: Colector: 18-1986-1 Junta codo: 18-0943-2 Kit de montaje: 18-8507</p>	 <p>18-1939 CODO Reemplaza: Barr 20-0100, Marine Power 0992-593 Barr, Indmar y Marine Power Ford bloques pequeños V8 302-351cu.in., GM bloques pequeños V8 305-350cu.in., GM bloque grande V8 454cu.in. Usar con: Colector: 18-1997-1, 18-1998-1 Junta codo: 18-2854-1 abierto o 18-0476-1 cerrado Kit montaje: 18-4364 abierto o 18-8535 cerrado 4" manguera</p>
----------------------------------------------------------------------------------------------------------------------------------------------------------------------------------------------------------------------------------------------------------------------------------------------------------------------------------------------------------------------------------------------------------------------------------------------------------------------------------------------------------------------------------------------------------------------------------------	-------------------------------------------------------------------------------------------------------------------------------------------------------------------------------------------------------------------------------------------------------------------------------------------------------------------------------------------------------------------------------------------------------------------------------------------------------------------------------------------------------------------------------------------------------------------------------------------------------

 <p>18-1907 HGE 18-1907S HGE CODO Reemplaza: Barr 20-0102, Indmar 53-2009, 53-2018, Barr y Indmar Ford bloque pequeño V8 302-351cu.in. Usar con: Colector: 18-1997-1, 18-1998-1 Junta codo: 18-2854-1 open or 18-0476-1 cerrado Kit montaje: 18-4364 abierto o 18-8535 cerrado 3" manguera</p>	 <p>18-1999 HGE 18-1999S HGE COLECTOR CODO ESCAPE Reemplaza: Barr 20-0082 Usar con : Colector: 18-1997-1 or 18-1998-1 Junta codo: 18-2854-1 abierto 3 1/2" manguera Abierto está dentro del kit de montaje 18-4364 Si es cerrado, es necesario utilizar el kit de montaje 18-8535 Reemplaza: Barr 20-0082-P</p>	 <p>18-4009 PLATINA COLECTOR Reemplaza: 910384</p>
------------------------------------------------------------------------------------------------------------------------------------------------------------------------------------------------------------------------------------------------------------------------------------------------------------------------------------------------------------------------------------------------------------------------------------------------------------------------------------------------------------------------------------------------	------------------------------------------------------------------------------------------------------------------------------------------------------------------------------------------------------------------------------------------------------------------------------------------------------------------------------------------------------------------------------------------------------------------------------------------------------------------------------------------------------------------------------------------------------------------------------------------------------------	---------------------------------------------------------------------------------------------------------------------------------------------------------------------------------

 <p style="text-align: center;">TAPONES</p> <table border="1" style="width: 100%; border-collapse: collapse; text-align: center;"> <thead> <tr> <th>Ref #</th> <th>Tamaño rosca</th> </tr> </thead> <tbody> <tr> <td>18-4256</td> <td>1/4"</td> </tr> <tr> <td>18-4257</td> <td>1/4"</td> </tr> <tr> <td>18-4258</td> <td>3/4"</td> </tr> <tr> <td>18-4263</td> <td>1/8" - 27 NPT</td> </tr> <tr> <td>18-4264</td> <td>3/8" - 18 NPT</td> </tr> </tbody> </table> <p style="font-size: small; text-align: center;">56507 Sellado con Teflon® Recomendado para conexiones.</p>	Ref #	Tamaño rosca	18-4256	1/4"	18-4257	1/4"	18-4258	3/4"	18-4263	1/8" - 27 NPT	18-4264	3/8" - 18 NPT	 <p>18-4461 CONECTOR Manguera 3/4" - 14 NPT X 1" Conexiones resistentes a la corrosión</p>	 <p>18-8216 CONECTOR 1/2" - 14 NPT X 3/4" barb Para: OMC- 6 Cilindros en línea</p>	 <p style="text-align: right;">① 18-4218 Display Package</p> <p>18-4218 TAPÓN VACIADO DE LATÓN Reemplaza: 379957 1/4" 18-3223-9 envase 12</p>
Ref #	Tamaño rosca														
18-4256	1/4"														
18-4257	1/4"														
18-4258	3/4"														
18-4263	1/8" - 27 NPT														
18-4264	3/8" - 18 NPT														

① Referencias acabadas en "D" envasadas - Referencias normales no envasadas

APLICACIONES EN LA PÁGINA 240



18-4363
KIT DE MONTAJE
Reemplaza: Barr FM-1-83-P
Usar con:
Colector: 18-1998-1



18-4364 (abierto)
KIT DE MONTAJE
Reemplaza: Barr 20-0082-P
Usar con
Codigo: 18-1999, 18-1939, 18-1907



18-8502
KIT MONTAJE
OMC GM Bloque pequeño V8 305-350cu.in. (1979-89) OMC/Volvo GM bloque pequeño 305-350cu.in.
Usar con:
Colector: 18-1931-1, 18-1902 & 18-1903



18-8507
KIT DE MONTAJE
OMC/Volvo GM
Bloque pequeño V8 305-350cu.in.
Usar con:
Codigo: 18-1909-1



18-8534
KIT DE MONTAJE
OMC GM Bloque pequeño V8 305-350cu.in. (1979-1989) y aplicaciones multiples codos Ford y GM
Usar con:
Codigo: 18-1921

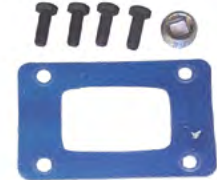

18-8535 (CERRADO)
KIT DE MONTAJE
Barr, Indmar y Marine Power Ford bloque pequeño V8 302-351cu.in., GM bloque pequeño V8 305-350cu.in., GM bloque grande V8 454cu.in.
Usar con:
Codos: 18-1939, 18-1999, and 18-1907



18-8536
KIT DE MONTAJE
Barr, Indmar y Marine Power GM bloque pequeño V8 305-350cu.in.
Usar con:
Colector: 18-1997-1



18-8538
KIT DE MONTAJE
Barr y Indmar Ford bloque pequeño V8 302-351cu.in.
Usar con:
Colector: 18-1998-1, 18-1904



18-8553
KIT DE MONTAJE
Usar con:
Codigo escape: 18-1921



18-2779 CEF
18-2779S
MANGUERA ESCAPE
Reemplaza: 3852696



18-2781 CEF
18-2781S
MANGUERA ESCAPE
Reemplaza: 3852742



18-0114
JUNTA COLECTOR
Reemplaza: 907761



18-0183-1
JUNTA COLECTOR ESCAPE
Reemplaza: 908717, 916262, 3852455, 3853742
Usar con:
Colector: 18-1958, 18-1962, 18-1904, 18-1998-1, 18-1996, 18-1979



18-0476-1 (CERRADO)
JUNTA CODO
Reemplaza: Barr 01-0105
Indmar & Marine Power
Ford bloque pequeño V8 302-351cu.in.
Usar con:
Codos: 18-1939, 18-1999 y 18-1907



PACK DE 2





18-0943-2
18-0943-2-9①
JUNTA CODO ESCAPE
Reemplaza: 909786, 3850496
Usar con:
Codigo: 18-1909-1

① Precio por pack

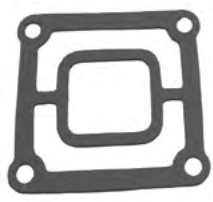
APLICACIONES EMPIEZAN EN LA SIGUIENTE PÁGINA

<p>PACK DE 2</p>  <p>18-2850 18-2850-9① JUNTA CODO ESCAPE Reemplaza: 908935</p>	<p>PACK DE 2</p>  <p>18-2854-1 18-2854-9① JUNTA CODO ESCAPE Reemplaza: Barr 01-0107 Usar con: Kit de montaje: 18-8535 Codos: 18-1999, 18-1939, 18-1907</p>	<p>PKG OF 2</p>  <p>18-2861-1 18-2861-9① JUNTA CODO ESCAPE Reemplaza: 311121</p>
---------------------------------------------------------------------------------------------------------------------------------------------------------------------------------------------------------------------	----------------------------------------------------------------------------------------------------------------------------------------------------------------------------------------------------------------------------------------------------------------------------------------------------------------------------------------------------------------	------------------------------------------------------------------------------------------------------------------------------------------------------------------------------------------------------------------------

<p>PACK DE 2</p>  <p>18-2875-1 18-2875-1-9① JUNTA CODO ESCAPE Reemplaza: 3850495, 908013 Usar con: Codo: 18-1922</p>	 <p>18-2896 JUNTA COLECTOR Reemplaza: 311068 Para GM 4 cil. 153 cu.in. primeros modelos 110/120 donde el carburador. va montado en la parte trasera del motor Usar con: Colector: 18-1904</p>
-----------------------------------------------------------------------------------------------------------------------------------------------------------------------------------------------------------------------------------------------------------------------------------------------------	-----------------------------------------------------------------------------------------------------------------------------------------------------------------------------------------------------------------------------------------------------------------------------------------------------------------------------------------------------------------------------------------

<p>PACK DE 2</p>  <p>18-2902-1 18-2902-9① JUNTA COLECTOR Reemplaza: 909314 Usar con: Colector: 18-1997-1, 18-1986-1, 18-1902, 18-1903</p>	<p>PACK DE 2</p>  <p>18-2949 18-2949-9① JUNTA COLECTOR Reemplaza: Barr CHV-47-000 Usar con: Colector: 18-1997-1</p>
--------------------------------------------------------------------------------------------------------------------------------------------------------------------------------------------------------------------------------------------------------------------------------------------------------------------------	-----------------------------------------------------------------------------------------------------------------------------------------------------------------------------------------------------------------------------------------------------------------------------------------------------

 <p>18-0603 JUEGO JUNTAS COLECTOR ESCAPE Para: Motores Ford 302/351 CID. Usar con: Colector: 18-1998-1</p>	 <p>18-0604 JUEGO JUNTAS COLECTOR ESCAPE Para: Motores GM 305/350 CID Usar con: Colector: 18-1997-1</p>
---------------------------------------------------------------------------------------------------------------------------------------------------------------------------------------------------------------------------------------------------------------------------------	--------------------------------------------------------------------------------------------------------------------------------------------------------------------------------------------------------------------------------------------------------------------------------

① Precio por pack

APLICACIÓN COLECTOR/JUNTA COLECTOR

Año	Potencia	Colector escape	Codo escape	Kit montaje colector	Kit montaje Codo	Junta Colector	Junta codo
1997-98	5.0/5.7L	18-1986-1	18-1909-1	18-8502	18-8507	18-2902-1	18-0943-2
1994-97	5.8L (Ford)	—	—	—	—	18-0183-1	18-0943-2
1994-97	7.4L (GM)	—	—	—	—	18-0418	18-0943-2
1991-93	3.0 Litro	—	18-1922	—	—	—	18-2875-1
1992-93	4.3/4.3 HO	—	18-1909-1	—	18-8507	—	18-0943-2
1993	5.0/5.0 HO/5.8 Litro	—	18-1909-1	—	18-8507	18-0183-1	18-0943-2
1993	5.0 & 5.8 EFI	—	18-1909-1	—	18-8507	18-0183-1 ②	18-0943-2
1993	5.0 & 5.8 EFI	—	18-1909-1	—	18-8507	—	18-0943-2
1993	5.8L (Ford)	—	18-1909-1	—	18-8507	18-0183-1	18-0943-2
1993	7.4L (GM), 8.2L (GM)	—	18-1909-1	—	18-8507	18-0418	18-0943-2
1993	351 King, 454/454 HO/502	—	—	—	—	—	18-0943-2
1992	5.0/5.0 HO/5.8 Litro	—	18-1909-1	—	18-8507	18-0183-1	18-0943-2
1992	5.8L (Ford)	—	—	—	—	18-0183-1	18-0943-2
1992	7.4L (GM), 8.2L (GM)	—	—	—	—	18-0418	18-0943-2
1992	351 King Cobra	—	—	—	—	18-0183-1	18-0943-2
1992	454/454 HO/502	—	—	—	—	—	18-0943-2
1991	4.3/4.3 HO	—	—	—	—	—	18-0943-2
1991	5.8L (Ford), 5.0/5.0HO/5.8 Litro	—	18-1909-1	—	18-8507	18-0183-1	18-0943-2

② Sólo 5.0L

APLICACIONES CONTINÚAN EN LA SIGUIENTE PÁGINA

APLICACIÓN COLECTOR/JUNTA COLECTOR

Año	Potencia	Colector escape	Codo escape	Kit montaje colector	Kit montaje Codo	Junta colector	Junta codo
1991	454/454 HO	—	18-1909-1	—	18-8507	—	18-0943-2
1991	7.4L (GM)	—	18-1909-1	—	18-8507	18-0418	18-0943-2
1990-91	8.2L (GM)	—	18-1909-1	—	18-8507	—	—
1982-83,1985-90	3.0 Litros	18-1901	18-1922	—	—	—	18-2875-1
1990	4.3 Litros	—	18-1909-1	—	18-8507	—	—
1990	5.0/5.0 HO/5.8 Litros	—	18-1921	—	—	18-0183-1	18-0943-2
1990	5.0/5.7L	18-1986-1	18-1909-1	18-8502	18-8507	18-2902-1	18-0943-2
1990	7.4L (GM)	—	—	—	—	18-0418	18-0943-2
1990	7.5L (Ford)	—	—	—	—	18-0992	18-0943-2
1990	454 King Cobra	—	—	—	—	—	18-0943-2
1987-90	460 King Cobra	—	—	—	—	—	18-0943-2
1989	5.0/5.0 HO/5.8 Litros	—	18-1921	—	18-8534	18-0183-1	18-0943-2
1989	5.7/350 King Cobra	—	—	—	—	18-2902-1	18-0943-2
1988	5.0/5.7/350 King Cobra	18-1902 #	18-1921	18-8502	18-8534	18-2902-1	18-0943-2
1988	5.0/5.7/350 King Cobra	18-1903 *	18-1921	18-8502	18-8534	18-2902-1	18-0943-2
1988	370 King Cobra	—	—	—	—	—	18-0943-2
1982-87	5.0/5.7 Litros	18-1902 #	18-1921 ①	18-8502	18-8534	18-2902-1	18-0943-2
1982-87	5.0/5.7 Litros	18-1903 *	18-1921	18-8502	18-8534	18-2902-1	18-0943-2
1982-86	2.5 Litros	18-1901	18-1922	—	—	18-2896-1	18-2875-1
1984	3.0 Litros	18-1901	18-1921	—	18-8534	—	18-2875-1
1978-81	400 Series, 120 HP	—	—	—	—	18-2896-1	18-2861-1
1978-81	400 Series, 140 HP	—	18-1922	—	—	—	18-2875-1
1981	800 Series, 200,230,260 HP	18-1902 #	18-1921	18-8502	18-8534	18-2902-1	18-0943-2
1981	800 Series, 200,230,260 HP	18-1903 *	18-1921	18-8502	18-8534	18-2902-1	18-0943-2
1980	800 Series, 185-260 HP	18-1902 #	18-1921	18-8502	18-8534	18-2902-1	18-0943-2
1980	800 Series, 185-260 HP	18-1903 *	18-1921	18-8502	18-8534	18-2902-1	18-0943-2
1979	800 Series,185-230 HP	18-1902 #	18-1921	18-8502	18-8534	18-2902-1	18-0943-2
1979	800 Series,185-230 HP	18-1903 *	18-1921	18-8502	18-8534	18-2902-1	18-0943-2
1979	800 Series, 260 HP	18-1902 #	18-1921	18-8502	18-8534	18-2902-1	18-0943-2
1979	800 Series, 260 HP	18-1903 *	18-1921	18-8502	18-8534	18-2902-1	18-0943-2
1978	800 Series, 185-225 HP	18-1902 #	18-1921	18-8502	18-8534	18-2902-1	18-0943-2
1978	800 Series, 185-225 HP	18-1903 *	18-1921	18-8502	18-8534	18-2902-1	18-0943-2
1978	800 Series, 240 HP	—	18-1921	—	18-8534	—	—
1977	120 HP	—	—	—	—	18-2896-1	18-0943-2
1977	140 HP	—	18-1922	—	—	—	18-2861-1
1977	175 Hasta 235 HP	—	18-1921	—	18-8534	18-0183-1	18-2875-1
1976	120 HP	18-1904	—	—	—	18-0183-1	18-0943-2
1974-76	140 HP	18-1904	18-1922	—	—	—	18-2861-1
1976	165 HP	18-1904	18-1922	—	—	18-2830-1	18-2875-1
1976	175 Hasta 235 HP	18-1904	—	—	—	18-0183-1	18-2875-1
1974-75	120 HP	18-1904	—	—	—	18-2896-1	18-2850
1974-75	165 HP	18-1904	18-1922	—	—	—	18-2875-1
1975	175 Hasta 235 HP	18-1904	—	—	—	18-0183-1	18-2875-1
1974	170 & 190 HP	18-1904	—	—	—	18-0183-1	18-2875-1
1974	175 THRU 235 HP	18-1904	—	—	—	18-0183-1	18-2850
1973	100,120,140 HP	—	—	—	—	18-2896-1	18-2861-1
1973	165 HP	—	18-1922	—	—	18-2896-1	18-2861-1
1972-73	225 & 245 HP	—	—	—	—	—	18-2883
1972	100,120 HP	—	—	—	—	18-2896-1	18-2861-1
1972	155 HP	—	—	—	—	N/D	18-2883
1972	165 HP S MODEL, C MODEL	—	—	—	—	—	18-2875-1
1971	215 & 235 HP	—	—	—	—	—	18-2859
1965-71	120 HP	—	—	—	—	—	18-2861-1
1967-71	155 HP	—	—	—	—	N/D	18-2859
1968-70	210 HP	—	—	—	—	—	18-2859
1967-68	185 HP	—	—	—	—	—	18-2859
1966-68	200 HP	—	—	—	—	N/D	18-2859
1964-66	150 HP	—	—	—	—	N/D	18-2859
1964	110 HP	—	—	—	—	N/D	18-2859

COLAS/COBRA - Sistema refrigeración
OMC

Estribor

* Babor

① Codo alto para 1985

② Sólo 5.0L

FILTRO ACEITE



Ref #	Para:	O.E.M #
18-7824-1	Motor GM (filtro corto)	173232, 502902
18-7875	motor Ford (Filtro largo)	173231, 502900
18-7876	Motor GM (Filtro largo)	173233, 502901
18-7878-1	M-100, M200 (Filtro corto)	502904
18-7879-1	Motor GM V-6	173834, 502903

CULATAS



18-4486 CULATA

Para: 5.7L V-8 GM Vortec (1996-sup) con 8 pernos en el colector de admisión.
Para tapa de válvula con tornillos en el centro.



18-4486HP CULATA

Para: Vortec GM Bloque pequeño 5.7L Altas prestaciones
Completamente ensamblado con carreras y camaras de combustión revisados. Añade 30 hp de potencia adicional sin modificaciones.



18-4485 HP CULATA

Para: 5.7L V-8 GM (1987-95) con 12 pernos en el colector de admisión. Para tapa de válvula con tornillos en el centro.



18-4501HP CULATA

Para: Vortec GM bloque pequeño 5.0L
Completamente ensamblado con carreras y camaras de combustión revisados. Añade 30 hp de potencia adicional sin modificaciones.



18-4501 CULATA

Para: 5.0L Vortec



PRONAUTIC
MARINE EQUIPMENT



18-1400
LEVA HIDRÁULICA
Reemplaza: 3856127
GM 4.3L/V-6/5.0L/5.7L



18-1401
LEVA HIDRÁULICA
Reemplaza: 3853847, 985316
Ford 5.0L y 5.8L



18-1402
LEVA HIDRÁULICA
Reemplaza: 3854033, 502036
GM 2.5L/120
Para: OMC & Volvo 3.0L/181 CID

TODOS LOS PISTONES
SE SUMINISTRAN COMPLETOS, CON AROS, BULÓN Y PASADOR.



AROS

STD	REEMPLAZA OMC / VOLVO
18-3937	*14089025
18-3937	328506
18-3937	3853960
18-3937	914555
18-3937	3853268
18-3937	985083, 986336
-	328536

AROS (Cont.)

STD	REEMPLAZA OMC / VOLVO
18-3944	370409
.020	
18-3939	3854252
18-3939	914556
.030	
18-3938	*14089026
18-3938	328516
18-3938	914557

PISTONES

18-4161	3853340
	914816
18-4173	*14077948
18-4173	3911020
.020	
18-4160	3853477, 915236
.030	
18-4164	*14077949
	3911023

* OMC Referencias GM Número

PISTONES / APLICACIONES ARO

Modelo	PISTONES			AROS			Cant. Per motor.
	Std.	.020	.030	Std.	.020	.030	
OMC							
GM							
2.5L/153 CID	18-4180	18-4183	-	18-3942	-	-	4
3.0L/181 CID	18-4161	18-4160	18-4191	18-3937	18-3939	18-3938	4
1-6/250 CID	-	-	-	18-3942	-	-	6
4.3L/V-6	18-4173	18-4188	18-4164	18-3937	18-3939	18-3938	6
5.0L/305 CID	-	-	18-4178	18-3944	-	-	8
5.7L/350 CID	18-4173	18-4188	18-4164	18-3937	18-3939	18-3938	8
7.4L/454 CID	18-4171	18-4189	18-4172	18-3940	-	-	8
FORD							
5.0L/302 CID	-	-	-	18-3937	18-3939	18-3938	8





COJINETE BIELA

Ref #	Tamaño
18-1308	Std.
18-1309	.010
18-1327	Std.
18-1329	Std.
18-1333	.010
18-1334	Std.
18-1337	.010
18-1341	.020

Se venden individualmente, 1 por biela



COJINETE CIGÜEÑAL

Ref #	Para Motor.	Tamaño
18-1311	②	Std.
18-1317	②	Std.

APLICACIÓN COJINETE

Modelo	COJINETE BIELA			COJINETE CIGÜEÑAL			COJINETE LEVA
	Std.	.010	.020	Std.	.010	.020	
OMC							
GM							
2.5L/153 CID	18-1329	18-1330	-	18-1317	18-1316	-	-
3.0L/181 CID	18-1308	18-1309	18-1341	18-1317	18-1316	-	-
I-6/230 CID	18-1329	18-1330	-	-	-	-	-
I-6/250 CID	18-1308	18-1309	18-1341	-	-	-	-
4.3L/V-6	18-1327	18-1337	-	18-1311	-	-	-
5.0L/305 CID	18-1308	18-1309	18-1341	-	-	-	-
5.7L/350 CID	18-1308	18-1309	18-1341	-	-	-	-
7.4L/454 CID	18-1334	18-1333	18-1332	-	-	-	-
FORD							
5.0L/302 CID	-	-	-	-	-	-	-



Retenes cigüeñal una pieza

18-1234
Reemplaza: 3853528
18-0519
Reemplaza: 3852657, 912957



Retenes cigüeñal dos piezas

18-0528
Reemplaza: 913745
18-1211
Reemplaza: 473424



Retenes tapa distribución

18-1213
Reemplaza: 3853341, 912989, 914817
18-1233
Reemplaza: 3860095
18-1230
Reemplaza: 3853827, 984884

APLICACION RETENES OMC

Modelo motor	2 Retén principal trasero Junta del cigüeñal Conv. Rotación (LH)	Retén tapa distribución
GM		
2.5L/153 CID	18-1211 ②	18-1213
3.0L/181 CID	18-1211 ②	18-1213
I-6/230CID	18-1211 ②	18-1213
I-6/250CID	18-1211 ②	18-1213
4.3L/V-6	18-1211 ②	18-1213
5.0L/305 CID	18-1211 ①	18-1213
5.7L/350 CID	18-1211 ①	18-1213
7.4L/454 CID	③	18-1233
FORD		
5.0L/302 CID	18-0528	
5.8L/351 CID	-	18-1230

① Cigüeñal largo motores GM ② Para retenes de una sola pieza (LH) Use 18-0519 ③ Para retenes de una sola pieza (LH) Use 18-1234

JUEGO DE JUNTAS VARIOS



18-0465
JUEGO JUNTAS COLECTOR ADMISIÓN
 Reemplaza: 352670
 Para: motores GM 454 CID, 325, 330, 340, 350 HP
 y 454 Magnums, 7.4L

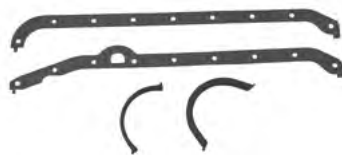

18-0153
JUEGO DE JUNTAS CARTER
 Reemplaza:
 393159, 458625, 357159
 Para: OMC 5.7L

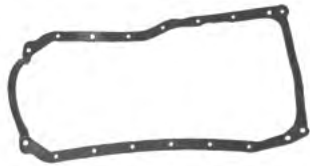

18-1239
JUNTA CÁRTER
 Reemplaza: 914820
 Para: OMC 3.0L

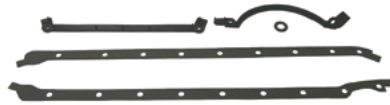

18-0348
JUEGO DE JUNTAS CARTER
 Reemplaza: 3931593, 508871

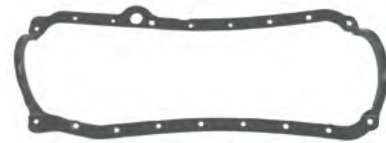

18-1237
JUNTA CARTER
 Reemplaza: 3856138
 Para: GM 5.7L



18-0466
JUEGO DE JUNTAS CARTER
 Reemplaza: 393061, 3923440, 3921473



18-1238
JUEGO DE JUNTAS
 Reemplaza: 3850379, 912979
 Para: OMC 4.3L 1993-96



18-1231
JUNTA ADMISIÓN
 Reemplaza: 3854095



18-0405
JUNTA CARTER
 Reemplaza:
 3852655, 912955
 Para: OMC 4.3L



18-0407
JUEGO JUNTAS CARTER
 Reemplaza: 508872



18-0410
JUEGO JUNTAS COLECTOR ADMISIÓN
 Reemplaza:
 988162, 3854406, 986103,
 3853912, 986104, 3853913
 Para: OMC 5.0L & 5.8L (1989-96)



18-0411
JUEGO JUNTAS CARTER
 Reemplaza:
 458625, 357159, 508876



18-1232
JUNTA CARTER
 Reemplaza: 3853510



18-0868
JUEGO JUNTAS COLECTOR DE ADMISIÓN
 Reemplaza:
 985630, 3854269
 Para: OMC 5.7L 1994, 1996-97

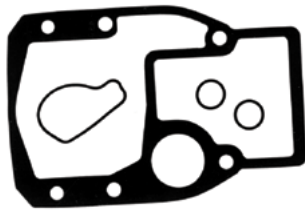

18-2613
JUEGO JUNTAS COLA

Reemplaza: 508105

— CONTIENE —

Ref #	Descripción	O.E. #	Cant.
18-2918	Junta	911836	1
18-2996	Retén	911823	1
18-7153	Aro tórico	911851	2

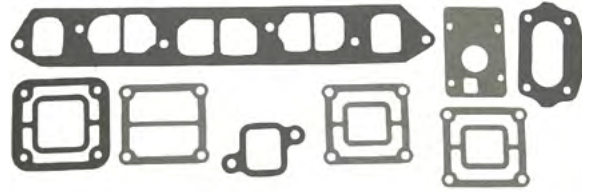

18-4369
JUEGO JUNTAS COLECTOR DE ESCAPE

Para: 2.5L (1985-86) y
3.0L (1985-88)



18-2699
JUEGO JUNTAS KIT MONTAJE

Para: colas SX

Use tuercas montaje 18-3721

— CONTIENE —

Ref #	Descripción	O.E. #	Cant.
18-7153	Aro tórico	911851	2
18-2996	Retén	911823	1

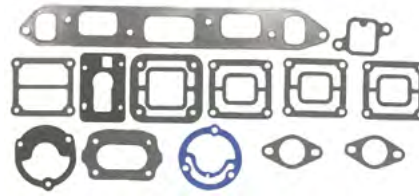

18-4370
JUEGO JUNTAS COLECTOR

Para: 100, 120 HP y 2.5L (1965-85)

— CONTIENE —

Ref #	Descripción	O.E. #	Cant.
18-0114	Junta colector	907761	1
18-2896-1	Junta colector escape	311068	1
18-0104	Junta codo escape	907764	1
18-0164	Junta alojamiento termostato	311069	1
18-0937	Juntas carburador	315055	1
18-2861-1	Junta	311121	3
18-2875-1	Junta de codo colector	908013	1
18-2858	Junta alojamiento termostato	314809	1



18-4408
JUEGO JUNTAS COLECTOR ENTRADA

Reemplaza 912978

Para: GM 4.3L

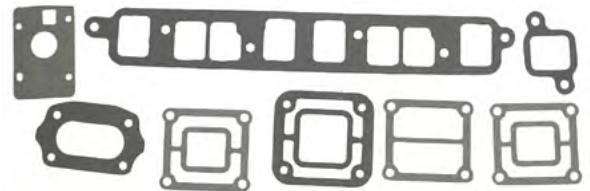

18-4371
JUEGO JUNTAS COLECTOR ESCAPE

Para: 140 HP y 3.0L (1973-84)

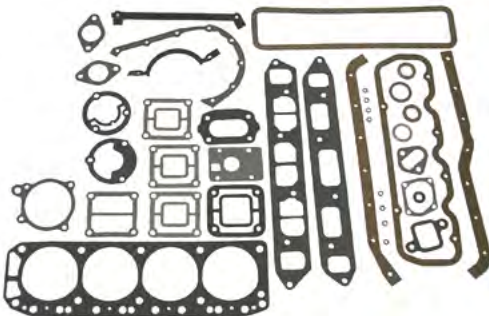



18-4373
JUEGO JUNTAS

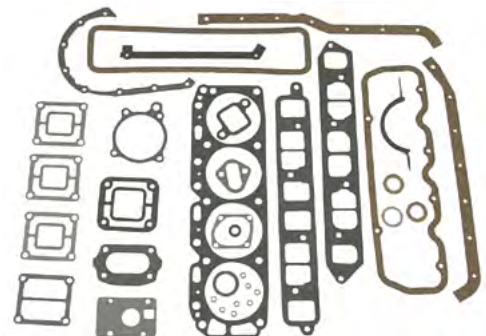



















Para: 110, 120 HP y 2.5L (1965-86)







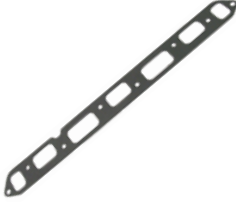



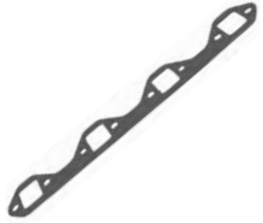



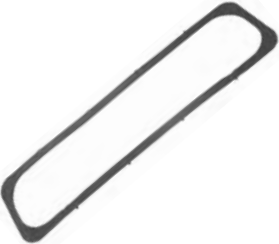

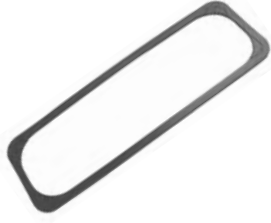



18-4374
JUEGO JUNTAS

Para: 140 HP y 3.0L (1973-88)

 <p>18-2946 MER52364 OEM JUNTA CULATA Reemplaza: 3853336, 908611 Para: motor GM 181 (3.0L) CID</p>	 <p>18-3874 JUNTA CULATA Reemplaza: 3853511 Para: (8.2L) 502 CID</p>	 <p>18-3876 JUNTA CULATA Reemplaza: 3853380, 914971 Para: motor GM 305 (5.0L)/350 (5.7L) CID.</p>	 <p>18-3877 JUNTA CULATA Reemplaza: 914849 Para: Motor GM 454 (7.4L) CID.</p>
 <p>18-3878 JUNTA CULATA Reemplaza: 912766 Para: 460 Ford</p>	 <p>18-3879 JUNTA CULATA Reemplaza: 3854299, 912227, 914930 Para: motor GM 262 (4.3L) CID.</p>	 <p>18-3880 JUNTA CULATA Reemplaza: 311210 Para: Motor GM 153 (2.5L), (3.0L) CID.</p>	 <p>18-3881 JUNTA CULATA Reemplaza: 908237 Para: motor GM 250 (4.1L) CID (6 cil).</p>
 <p>18-3883 JUNTA CULATA Reemplaza: 3853732 Para: motores Ford 302 (5.0L) 351 (5.8L) CID.</p>	 <p>18-3887 JUNTA CULATA Reemplaza: 915325 Para: (7.4L) 454 CID GEN V</p>	 <p>18-0434 JUNTA MONTAJE CARBURADOR Reemplaza: 909758</p>	<p>PACK DE 2</p>  <p>18-5399 18-5399-9① JUNTA TAPA DISTRIBUIDOR Reemplaza: 910169</p>
<p>PACK. DE 2</p>  <p>18-0874 18-0874-9① JUNTA DISTRIBUIDOR Para GM V6 & V8 Reemplaza: 3852109, 312780 Para: 2.6L (1989), 3.5L (1989), 4.3L (1987-93), 5.0L (1987-88), 5.7L (1987-92), 7.4L (1988-93), 8.2L (1992-93)</p>	<p>PACK. DE 2</p>  <p>18-0937 18-0937-9① JUNTA MONTAJE CARBURADOR Reemplaza: 315055</p>	 <p>18-0435 JUNTA MONTAJE CARBURADOR Reemplaza: 908765</p>	<p>PACK. DE 2</p>  <p>18-0876 18-0876-9① JUNTA BOMBA COMBUSTIBLE Para GM 4.3L, 5.0L & 5.7L Reemplaza: 3852113, 312800</p>
<p>PACK. DE 2</p>  <p>18-0164 18-0164-9① JUNTA TERMOSTATO 4 & 6 Cil. Reemplaza: 311069 GM 3789161</p>	<p>PACK. DE 2</p>  <p>18-0929 18-0929-9① JUNTA TERMOSTATO Reemplaza: 313416</p>	<p>PACK. DE 2</p>  <p>18-2858 18-2858-9① JUNTA TERMOSTATO Reemplaza: 314809</p>	<p>PACK. DE 2</p>  <p>18-2917 18-2917-9① JUNTA TERMOSTATO Reemplaza: 312797, 3701777 (GM)</p>

<p>PACK DE 2</p>  <p>18-2947 18-2947-9① JUNTA TERMOSTATO Reemplaza: 310913</p>	<p>PACK. DE 2</p>  <p>18-0398 JUNTA TERMOSTATO Reemplaza: 312797, 3852111</p>	<p>PACK. DE 2</p>  <p>18-0104 18-0104-9① JUNTA CODO ESCAPE Reemplaza: 907764</p>	 <p>18-0114 JUNTA COLECTOR Reemplaza: 907761 Para GM 4 Cil.</p>
 <p>18-0430 JUNTA CODO ESCAPE Reemplaza: 912477</p>	<p>PACK. DE 2</p>  <p>18-0673 18-0673-9① JUNTA CODO ESCAPE Reemplaza: 910113</p>	<p>PACK. DE 2</p>  <p>18-0943-2 18-0943-2-9① JUNTA CODO ESCAPE Reemplaza: 913783, 909786, 3850496</p>	<p>PACK. DE 2</p>  <p>18-2850 18-2850-9① JUNTA TAPA COLECTOR Reemplaza: 908935</p>
<p>PACK. DE 2</p>  <p>18-2859 18-2859-9① JUNTA TAPA COLECTOR Reemplaza: 311131</p>	<p>PACK. DE 2</p>  <p>18-2860 18-2860-9① JUNTA TAPA COLECTOR Reemplaza: 311130</p>	<p>PACK. DE 2</p>  <p>18-2861-1 18-2861-9① JUNTA TAPA COLECTOR Reemplaza: 311121</p>	<p>PACK DE 2</p>  <p>18-2875-1 18-2875-1-9① JUNTA CODO ESCAPE Reemplaza: 908013, 3850495</p>
<p>PACK. DE 2</p>  <p>18-2883-1 18-2883-1-9① JUNTA TAPA COLECTOR Reemplaza: 907775</p>	 <p>18-2541 RETÉN GOMA Reemplaza: 911704</p>	 <p>18-0401 JUNTA COLECTOR ESCAPE Reemplaza: 913393 Para Ford 140 CID (2.3L)</p>	 <p>18-0431 JUNTA COLECTOR ADMISIÓN Reemplaza: 912471 Para Ford 140 CID (2.3L)</p>
 <p>18-0956-1 JUNTA COLECTOR ESCAPE Reemplaza: 912405 460 CID</p>	 <p>18-2912-1 JUNTA COLECTOR ESCAPE Reemplaza: 908079</p>	 <p>18-2830-1 JUNTA COLECTOR ESCAPE Inline 6 cil. Reemplaza: 907932</p>	 <p>18-2896-1 JUNTA COLECTOR ESCAPE Reemplaza: 311068</p>

<p>PACK. DE 2</p>  <p>18-2909 18-2909-9① JUNTA COLECTOR ESCAPE Reemplaza: 915025 GM V-6</p>	 <p>18-0183-1 JUNTA COLECTOR ESCAPE Reemplaza: 3853742, 3852455, 908717, 916262 Para: OMC 5.0L & 5.8L (1993-96)</p>	 <p>18-0680 JUNTA COLECTOR ESCAPE Reemplaza: 3853256</p>	 <p>18-0418 JUNTA COLECTOR ESCAPE Reemplaza: 909613</p>
<p>PACK. DE 2</p>  <p>18-1204-1 18-1204-1-9① JUNTA COLECTOR ESCAPE Reemplaza: 912164</p>	 <p>18-0892 MANGUITO DEFLECTOR Reemplaza: 322411</p>	 <p>18-0664 JUNTA TAPA VÁLVULA Reemplaza: 913270, 3852687 Para: GM 305/350, 5.0 & 5.7L</p>	 <p>18-2845 JUNTA TAPA VÁLVULA Reemplaza: 912965 Para GM 305/350 CID (5.0L y 5.7L)</p>
 <p>18-0311 JUNTA TAPA VÁLVULA Reemplaza: 3854942 Para: 4.3 Litro 262 CID</p>	 <p>18-0346 JUNTA TAPA VÁLVULA Reemplaza: 3930912 Para: GM 250 CID (4.1L), 160/165/200 (6 cil.)</p>	 <p>18-0347  MER851040 OEM JUNTA TAPA VÁLVULA Reemplaza: 3852693, 912981, 913277 Para: GM 153 & 181 CID (2.5L & 3.0L)</p>	<p>Pack. de 2</p>  <p>18-0464 18-0464-9① JUNTA TAPA VÁLVULA Reemplaza: 912768 Para: GM 454/502 CID (7.4L & 8.2L)</p>
 <p>18-0352 JUNTA TAPA VÁLVULA Reemplaza: 913758 Para: Ford 302/351 CID (5.0L & 5.8L)</p>	 <p>18-0548 JUNTA ADAPTADOR A ALOJAMIENTO INTERMEDIO Reemplaza: 909515</p>	<p>Pack. de 2</p>  <p>18-0947 18-0947-9① JUNTA Reemplaza: 909529</p>	<p>Pack. de 2</p>  <p>18-0440 18-0440-9① JUNTA Reemplaza: 915719</p>
 <p>18-0911 JUNTA BOMBA AGUA Reemplaza: 911698</p>	<p>Pack. de 2</p>  <p>18-0903 JUNTA BOMBA AGUA Reemplaza: 3853361 454 CID</p>	 <p>18-0147 JUNTA BOMBA AGUA Para Ford V-8 Reemplaza: 3852824</p>	 <p>18-0327 JUNTA BOMBA AGUA Reemplaza: 3853342 4 & 6 Cil.</p>

PACK. DE 2



18-2916
18-2916-9①
JUNTA ALOJAMIENTO BOMBA AGUA
Reemplaza: 911702



18-0939
18-0939-9①
JUNTA
Reemplaza: 315189



18-0468
JUNTA TAPA DISTRIBUCIÓN
Reemplaza: 3853512, 912954, 3852654, 915326
Para: OMC 2.6L, 3.5L (1989), 4.3L (1987-93), 5.0L (1987-88), 5.7L (1987-92, 1994, 1996)

PKG. OF 2



18-0891
18-0891-9①
JUNTA MONTAJE BOMBA AGUA
Reemplaza: 3852477, 909835
Para: GM 4.3L, 5.0L & 5.8L

2



18-0893
18-0893-9①
JUNTA BOMBA AGUA
Reemplaza: 3850595
GM 4.3L, 5.0L & 5.7L

PKG. OF 2



18-0322
18-0322-9①
JUNTA
Reemplaza: 3852656
GM 5.0L & 5.7L



18-0329
junta varilla empuje

PKG. OF 2



18-0887
18-0887-9①
JUNTA TAPA DISTRIBUCIÓN
Reemplaza: 3852691, 912988, 913275
4 & 6 Cil.



18-0980
JUNTA TAPA DISTRIBUCIÓN
Reemplaza: 3935449
GM 7.4L

PKG. OF 2



18-0880
18-0880-9①
JUNTA TAPA CAMBIO
Reemplaza: 911878

PKG. OF 2



18-0166
18-0166-9①
CASQUILLO
Reemplaza: 911705



18-2815
MER8146801 OEM
VARILLA DE EMPUJE
Reemplaza: 3852692, 913276
Para: 3.0L



18-0190
JUNTA
Reemplaza: 912157

PACK. DE 2

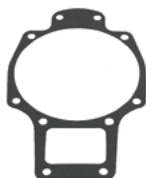

18-2851
18-2851-9①
JUNTA COJINETE
Reemplaza: 313368

PACK DE 2



18-2863
18-2863-9①
JUNTA TAPA TILT
Reemplaza: 308799



PRONAUTIC
MARINE EQUIPMENT

<p>PKG. OF 2</p>  <p>18-2911 18-2911-9① JUNTA ALOJAMIENTO COJINETE CARDAN Reemplaza: 910236</p>	<p>PKG. OF 5</p>  <p>18-2918 18-2918-9① JUNTA TRANSOM Reemplaza: 911836, 915840</p>	<p>PKG. OF 5</p>  <p>18-2996 18-2996-9① JUNTA RETÉN Reemplaza: 911823, 3852560</p>	<p>PKG. OF 2</p>  <p>18-0923 18-0923-9① RETÉN GOMA Reemplaza: 313244</p>
<p>PKG. OF 2</p>  <p>18-0188 18-0188-9① ARANDELA Reemplaza: 909748</p>	<p>PKG. OF 5</p>  <p>18-2387 18-23871-9① (PACK. DE 50) TORNILLO DRENAJE Reemplaza: 307551 Para: OMC V-6, V-4(1979 & Sup), 60-75hp 3 cilindro, 20-35hp (1985-97)</p>	<p>PKG. OF 5</p>  <p>18-1236 TORNILLO DRENAJE Reemplaza: 309243 Para Cobra Drives & V-6 40-50HP (1989-97)</p>	<p>PKG. OF 2</p>  <p>18-2378 18-23781-9① (Pack. de 50 sin arandela) TORNILLO MAGNÉTICO DE DRENAJE Reemplaza: 318544 Para: Cobra 2.3, 3.0, 3.8 & 5.8L (1986-92), V-6, V-4(1979 & Sup), 60-75hp 3 cil, 40/50hp (1989-98)</p>
<p>PACK. DE 5</p>  <p>18-4253-9① 18-42531-9① (Pack. de 50) ARO TÓRICO TORNILLO DRENAJE Reemplaza: 336982 Usar con tornillo 18-1236</p>	<p>PACK. DE 2</p>  <p>18-2945 18-2945-9① JUNTA TORNILLO DRENAJE Reemplaza: 307552</p>	<p>PKG. OF 2</p>  <p>18-8369 INDICADOR DE ACEITE CON ARANDELA Reemplaza: 914488 Usar aro 18-7116 Para: OMC Cobra (1986-93) Sin agarre cónico</p>	<p>PACK. DE 5</p>  <p>18-4248 18-4248-9① 18-42481-9① (PACK. DE 50) ARANDELA (Plástico) Reemplaza: 311598</p>
<p>PACK. DE 5</p>  <p>18-4250 18-4250-9① ARANDELA Reemplaza: 911820</p>	<p>TAPA TAPÓN</p>  <p>18-0549 Reemplaza: 909829 D.I. 1" Para modelo V-8 transmisión e intraborda (1977 hasta hoy)</p> <p>18-0550 Reemplaza: 909830 D.I. 1 1/4" Para modelo V-8 transmisión e intra borda (1977 hasta hoy)</p>	<p>PKG. OF 2</p>  <p>18-0518 RETÉN VÁLVULA Reemplaza: 3854956, 914323, 3853132 Para: mayoría 4 y 6 cil. en línea GM (primeros) y 305-350 CID GM</p>	<p>PACK. DE 8</p>  <p>18-4024 18-4024-9① RETÉN VÁLVULA Reemplaza: 3853226, 914445 Para: Chevy 4.3L/5.0L/5.7L</p>

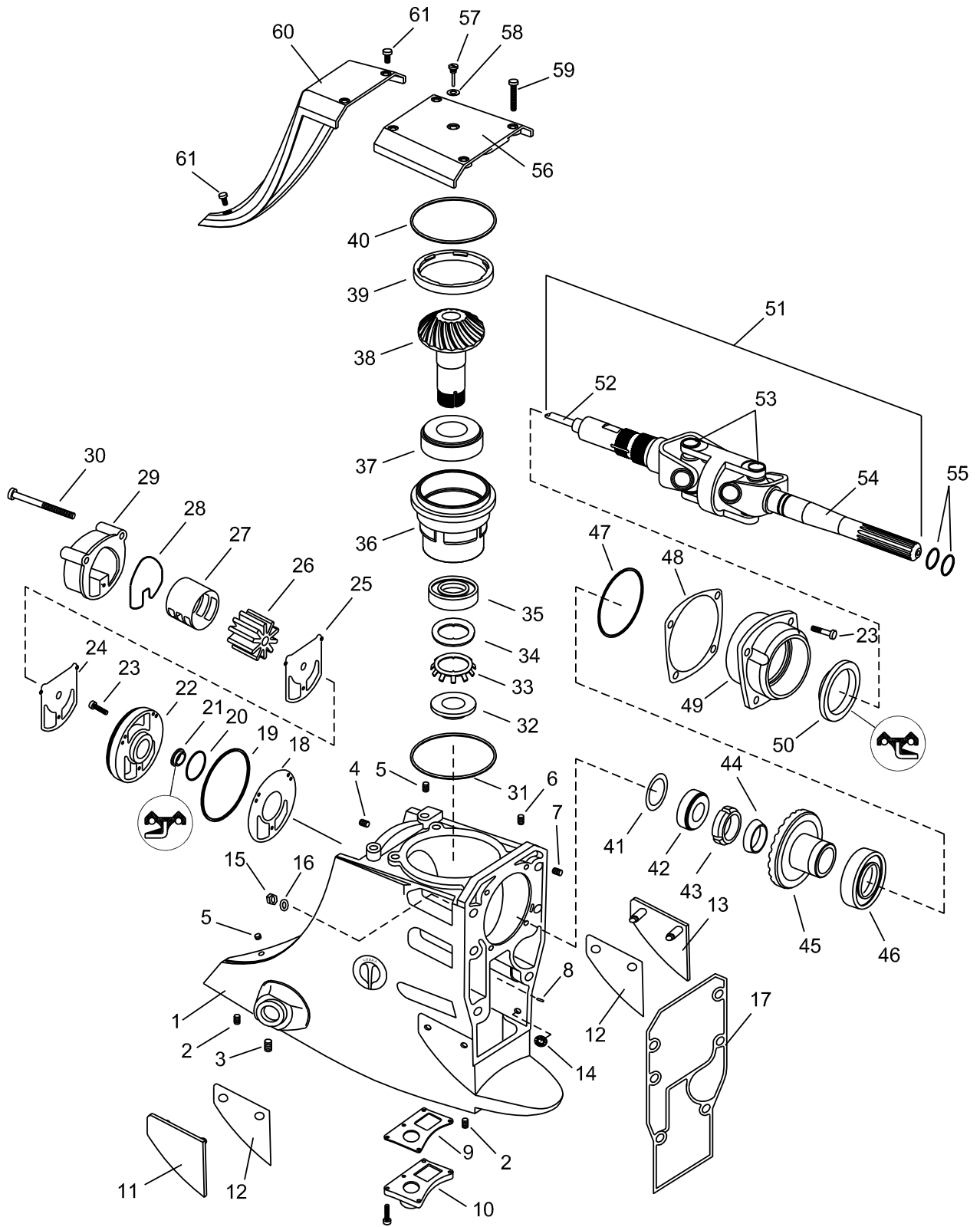

Núm. #	Descripción	Ref #	O.E.M. #	Cant.	Núm #	Descripción	Ref #	O.E.M. #	Cant.
1	Alojamiento superior, Básico con Inserción	~	984518	1	32	Tuerca piñón	18-3769	911753	1
					33	Tuerca	18-3610	911752	1
2	Inserción cola	NSS	910935	5	34	Arandela piñón	NSS	911697	1
3	Inserción cola	NSS	911779,	5	35	Cojinete	18-1170	983892	1
			3852541		36	Cojinete de apoyo piñón	18-4828	911750	1
4	Inserción cola	NSS	910901	5	37	Cojinete piñón superior	18-1161	983891	1
5	Inserción cola	NSS	911858,	3	38	Set engranajes, 21:16 (incluye 38 & 45)	18-1600	983825	AR
			3852567		38	Set engranajes, 21:18 (incluye 38 & 45)	18-1601	983826	AR
6	Inserción cola	NSS	910901	4	38	Set engranajes, 21:19 (incluye 38 & 45)	18-1602	984012	AR
7	Inserción cola	NSS	910901	4					
8	Guía cambio	NSS	912137	1	39	Tuerca	18-3768	911751	1
9	Junta	18-0884	911733	1	40	Aro tórico	18-7107	313175	1
10	Tapa	18-4837	911734	1					
11	Platina empuje estribor	NSS	911838,	1	41	Cojinete posición engr. 0.003"	18-02062	911662	AR
			3852562		41	Cojinete posición engr. 0.005"	18-02063	911663	AR
12	Placa, 0.015"	18-1713	911839,	AR	41	Cojinete posición engr. 0.007"	NSS	911664	AR
			3852563		41	Cojinete posición engr. 0.010"	18-02065	911665	AR
13	Placa babor	NSS	911837,	1	41	Cojinete posición engr. 0.012"	18-02066	911666	AR
14	Aro y placa empuje	NSS	910953		4	41	Cojinete posición engr. 0.015"	18-02067	911667
15	Tuerca	18-3730	912920,	6	42	Cojinete cardan	18-1171	983878	1
			3852648		43	Tuerca	18-3770	911937	1
16	Arandela	NSS	911833	6	44	Cono	18-4835	912029	1
17	Junta	18-2918	911836,	1	45	Set engranajes, 21:16 (incluye 38 & 45)	18-1600	983825	AR
18	Junta	18-0911	911698		1	45	Set engranaje, 21:18 (incluye 38 & 45)	18-1601	983826
19	Aro tórico	18-7407	911700	1	45	Set engranajes, 21:19 (incluye 38 & 45)	18-1602	984012	AR
20	Aro tórico	18-7403	909316	1					
21	Retén bomba agua	18-2068	911701,	1	46	Cojinete cónico	18-1172	983877	1
			915702,		47	Aro tórico	18-7169	911686	1
22	Adaptador	18-4836	911699	1	48	Cojinete de apoyo 0.003", verde	18-0227	911678	AR
23	Tornillo	18-1598	908668,	6	48	Cojinete de apoyo, 0.004", Naranja	18-0229	911679	AR
			341013		48	Cojinete de apoyo, 0.005", Azul	18-02060	911680	AR
24	Junta	18-2916	911702	1	48	Cojinete de apoyo 0.010", Marrón	18-02061	911681	AR
25	Platina impulsor	18-3121	911703	1					
26	Impulsor	18-3058 18-3058S	983895, 777128	1	49	Cojinete engranaje	18-4838	911683	1
27	Alineador tapa bomba agua	18-3145	911844	1	50	Retén aceite	18-2067	911685	1
28	Retén alojamiento bomba agua	18-2541	911704	1	51	Cruceta	18-2338	983880	1
29	Impulsor alojamiento	18-3206	984744	1					
30	Tornillo	NSS	912238	3	52	Eje y alojamiento	18-6399	984264	1
31	Cojinete de apoyo 0.010	18-0207	911668	AR	53	Cruceta cardan	18-2104	912214	2
31	Cojinete de apoyo 0.001	18-0209	911669,	AR	54	Eje	18-2146	912212	1
			911670,		55	Aro tórico	18-7153	911851,	
			611671,			3852563	2		
			911672,		56	Tapa alojamiento engranaje	18-4838	911845,	
			911673,			986363	1		
			911674,		57	Indicador aceite	18-8369	914488	1
			911675,		58	Aro tórico	18-7116	303067	1
911676,	59	tornillo	18-1599	123018	4				
911677					60	Tapa	18-4750	983967	1
31	Cojinete de apoyo 0.003	18-0211	911669,	AR	61	Tornillo	18-4749-9	911859,	3
			911670,			3852568			
			611671,			Kit alojamiento reparación bomba agua	18-3348	984461,	1
			911672,					984744	
			911673,						
			911674,						
			911675,						
			911676,						
			911677						

AR Se requiere

NSS No se vende por separado



PARTE SUPERIOR COMPLETA

Ref No.	OE No.	Descripción	Aplicación
18-4804	984770, 986381	Unidad superior Completa, 21:16 Ratio	5.7L (1986-93), 5.8L(1986-89,1991-93)
18-4805	984771, 986382	Unidad superior Completa, 21:18 Ratio	2.5L (1986-89), 3.0L(1986-93), 5.0L (1989-93)
18-4806	984765, 986380	Unidad superior Completa, 21:19 Ratio	4.3L, 3.0L altura alta OMC Cobra (1986-93)



Tornillos

Ref.	OE No.	Aplicación
18-1279	317624	20, 25 35 HP (1976-86), 120, 140, 275, 300 HP (1985-86) Cobra
18-1598	341013	Para: OMC Cobra (1986-93) sin acoplamiento cónico
18-1599	123018	Para: OMC Cobra (1986-93) sin acoplamiento cónico
18-3135	306643	Colas Cobra
18-4749-9①	3852568	Para ensamble tapa: (3 Pack)Para: 2.3L (1987-90), 2.5L (1986), 2.6L (1989), 3.0L (1986-93), 4.3L (1986-93), 5.0L (1986-94), 5.7L (1986-92), 5.8L (1989-93), 7.4L (1988)

① Pack de 3, precio por pack

ARANDELA

Ref.	O.E. No.	Tam	Ref.	O.E. No.	Tamaño
18-0207 ①	911668	0.010	18-02065 ①	911665	0.010
18-0209 ①	911669, 911670, 911671, 911672, 911673, 911674, 911675, 911676, 911677	0.001	18-02066 ①	911666	0.012
18-0211 ①	911669, 911670, 911671, 911672, 911673, 911674, 911675, 911676, 911678	0.003	18-02067 ①	911667	0.015
18-0227 ① ②	911678	0.003	18-2229	323362	0.003
18-0229 ① ③	911679	0.004	18-2230	323361	0.004
18-1713 ①	3852563	0.015	18-2231	314745	0.005
18-1718 ⑥	-	Kit			
18-02060 ① ④	911680	0.005			
18-02061 ① ⑤	911681	0.010			
18-02062 ①	911662	0.003			
18-02063 ①	911663	0.005			



- ① Para: OMC Cobra (1986-93) sin acopl. cónico
- ② verde
- ③ Naranja
- ④ Azul
- ⑤ Marrón
- ⑥ Kit incluye 1 de cada uno de 18-2229, 18-2230 & 18-2231

NOTA: Para tamaños más largos que .010" usar 18-0207 y la combinación apropiada .001"calce (18-0209), y .003" calce (18-0211) Para alcanzar el espesor adecuado.



18-4442
HERRAMIENTA ALINEACIÓN
 Para verificar alineación de motor en modelos cobra.



18-9876
HERRAMIENTA DE CALIBRACIÓN
 Reemplaza: 349957



18-4801
PARTE INFERIOR COLA
 Reemplaza: 50000356.
 Para: 85-140HP.



18-2100
COJINETE CARDAN
 Reemplaza: 983937
 Usar retén 18-8349
 Para todos OMC Cobra y Colas King Cobra



18-3763
EJE CAMBIO
 Reemplaza: 322941
 Para: V-4/V-6, Cobra, Stringer



18-2337
UNIÓN COLA-CARDAN
 Reemplaza: 3850814
 Para: Todos Cobra 1994-Sup excepto King Cobra



18-6399
ACOPLAMIENTO EJE
Reemplaza: 984264

Para: colas Cobra- 232, 302(1986-90), 252(1986), 262, 350, 460(1989), 432, 434, 502(1986-92), 504(1986-88), 574(1986-92), 584(1989-93), 754(1987-88)



18-2104
CRUCETA CARDAN
Heavy Duty

Reemplaza: 912214, 915716
Para colas OMC Cobra (1986-89) Incluye conexiones rectas y de 90° (Rockwell)



18-2174
CRUCETA CARDAN
Heavy Duty

Reemplaza: 915717, 3850812
Para colas OMC Cobra y King Cobra (1990 & SUP) Incluye conexiones rectas y 90° (Rockwell)



18-2338
CARDAN COMPLETA
Reemplaza: 983880

Para: 1986-93 OMC Cobra



18-2339
CARDAN COMPLETA
Reemplaza: 3852384

Para: Todos Cobra 1994-sup excepto King Cobra



18-2146
ACOPLAMIENTO EJE CRUCETA
Reemplaza: 912212, 3850815

Para: Todos Cobra (1986-Sup)



18-3770
TUERCA
Reemplaza: 911937

Para: 232, 252, 262, 302, 350, 432, 434, 460, 502, 504, 574, 584, 744, 754, (1987-93)

Modelo	Año	Cruceta Cardán #	Cardan. OE #	Eje largo #	Eje largo OE #	Eje corto #	Eje corto OE #
2.3L	1986 ①	18-2338	983880	18-2146	812212	18-6399	984264
3.0L	1986 ①	18-2338	983880	18-2146	812212	18-6399	984264
4.3L	1986 ①	18-2338	983880	18-2146	812212	18-6399	984264
5.7L	1986 ①	18-2338	983880	18-2146	812212	18-6399	984264
2.3L	1987-1988 ①	18-2338	983880	18-2146	912212	18-6399	984264
3.0L	1987-1988 ①	18-2338	983880	18-2146	912212	18-6399	984264
4.3L	1987-1988 ①	18-2338	983880	18-2146	912212	18-6399	984264
5.0L	1987-1988 ①	18-2338	983880	18-2146	912212	18-6399	984264
5.7L	1987-1988 ①	18-2338	983880	18-2146	912212	18-6399	984264
7.5L	1987-1988 ①	18-2338	983880	18-2146	912212	18-6399	984264
2.3L	1989 ①	18-2338	983880	18-2146	912212	18-6399	984264
3.0L	1989 ①	18-2338	983880	18-2146	912212	18-6399	984264
4.3L	1989 ①	18-2338	983880	18-2146	912212	18-6399	984264
5.0L	1989 ①	18-2338	983880	18-2146	912212	18-6399	984264
5.7L	1989 ①	18-2338	983880	18-2146	912212	18-6399	984264
5.8L	1989 ①	18-2338	983880	18-2146	912212	18-6399	984264
7.5L	1989 ①	18-2338	983880	18-2146	912212	18-6399	984264
2.3L	1990 ②	18-2338	983880	18-2146	912212	18-6399	984264
3.0L	1990 ②	18-2338	983880	18-2146	912212	18-6399	984264
4.3L	1990 ②	18-2338	983880	18-2146	912212	18-6399	984264
5.0L	1990 ②	18-2338	983880	18-2146	912212	18-6399	984264
5.7L	1990 ②	18-2338	983880	18-2146	912212	18-6399	984264
5.8L	1990 ②	18-2338	983880	18-2146	912212	18-6399	984264

APLICACIONES CONTINÜAN EN LA SIGUIENTE PÁGINA

① Used where raw w/p is located on outdrive ② Used where raw w/p is located on engine ③ Excluye Modelo 58FBPMDA, used where raw w/p is located on engine
④ Used where raw w/p is located on engine, incl. Model 58FBPMDA

Modelo	Año	Cruceta Cardán #	Cardan. OE #	Eje largo #	Eje largo OE #	Eje corto #	Eje corto OE #
5.7L	1990 ①	18-2338	983880	18-2146	912212	18-6399	984264
7.4L	1990 ①	18-2338	983880	18-2146	912212	18-6399	984264
7.5L	1990 ①	18-2338	983880	18-2146	912212	18-6399	984264
3.0L	1991 ①	18-2338	983880	18-2146	912212	18-6399	984264
4.3L	1991 ①	18-2338	983880	18-2146	912212	18-6399	984264
5.7L	1991 ①	18-2338	983880	18-2146	912212	18-6399	984264
5.8L	1991 ①	18-2338	983880	18-2146	912212	18-6399	984264
7.4L	1991 ②	N/D	986191	18-2146	912212	N/D	914646
3.0L	1992-1993 ①	18-2338	983880	18-2146	912212	18-6399	984264
3.2L	1992-1993 ①	18-2338	983880	18-2146	912212	18-6399	984264
4.3L	1992-1993 ①	18-2338	983880	18-2146	912212	18-6399	984264
5.0L	1992-1993 ①	18-2338	983880	18-2146	912212	18-6399	984264
5.7L	1992-1993 ①	18-2338	983880	18-2146	912212	18-6399	984264
5.8L	1992-1993 ①	18-2338	983880	18-2146	912212	18-6399	984264
3.0L	1992-1993 ②	N/D	986191	18-2146	912212	N/D	914646
3.2L	1992-1993 ②	N/D	986191	18-2146	912212	N/D	914646
4.3L	1992-1993 ②	N/D	986191	18-2146	912212	N/D	914646
5.0L	1992-1993 ②	N/D	986191	18-2146	912212	N/D	914646
5.7L	1992-1993 ②	N/D	986191	18-2146	912212	N/D	914646
5.8L	1992-1993 ②	N/D	986191	18-2146	912212	N/D	914646
7.4L	1992-1993 ②	N/D	986191	18-2146	912212	N/D	914646
8.2L	1992-1993 ②	N/D	986191	18-2146	912212	N/D	914646
3.0L	1994 ③	18-2339	3852384	18-2146	3850815	18-2337	3850814
4.3L	1994 ③	18-2339	3852384	18-2146	3850815	18-2337	3850814
5.0L	1994 ③	18-2339	3852384	18-2146	3850815	18-2337	3850814
5.7L	1994 ③	18-2339	3852384	18-2146	3850815	18-2337	3850814
5.8L	1994 ③	18-2339	3852384	18-2146	3850815	18-2337	3850814
5.8L	1994 ④	N/D	3853937	18-2146	3850815	N/D	3853563
7.4L	1994 ④	N/D	3853937	18-2146	3850815	N/D	3853563
3.0L	1995 ②	18-2339	3852384	18-2146	3850815	18-2337	3850814
4.3L	1995 ②	18-2339	3852384	18-2146	3850815	18-2337	3850814
5.0L	1995 ②	18-2339	3852384	18-2146	3850815	18-2337	3850814
5.8L	1995 ②	18-2339	3852384	18-2146	3850815	18-2337	3850814
7.4L	1995 ②	N/D	3853937	18-2146	3850815	N/D	3853563
3.0L	1996 ②	18-2339	3852384	18-2146	3850815	18-2337	3850814
4.3L	1996 ②	18-2339	3852384	18-2146	3850815	18-2337	3850814
5.0L	1996 ②	18-2339	3852384	18-2146	3850815	18-2337	3850814
5.7L	1996 ②	18-2339	3852384	18-2146	3850815	18-2337	3850814
5.8L	1996 ②	18-2339	3852384	18-2146	3850815	18-2337	3850814
7.4L	1996 ②	18-2339	3852384	18-2146	3850815	18-2337	3850814
3.0L	1997 ②	18-2339	3852384	18-2146	3850815	18-2337	3850814
4.3L	1997 ②	18-2339	3852384	18-2146	3850815	18-2337	3850814
5.7L	1997 ②	18-2339	3852384	18-2146	3850815	18-2337	3850814
7.4L	1997 ②	18-2339	3852384	18-2146	3850815	18-2337	3850814
3.0L	1998 ②	18-2339	3852384	18-2146	3850815	18-2337	1850814
4.3L	1998 ②	18-2339	3852384	18-2146	3850815	18-2337	1850814
5.0L	1998 ②	18-2339	3852384	18-2146	3850815	18-2337	1850814
5.7L	1998 ②	18-2339	3852384	18-2146	3850815	18-2337	1850814
7.4L	1998 ②	18-2339	3852384	18-2146	3850815	18-2337	1850814
8.2L	1998 ②	18-2339	3852384	18-2146	3850815	18-2337	1850814
43APHUB	1995	18-2339	3852384	18-2146	3850815	18-2337	3850814
43FAPNCA	1996	18-2339	3852384	18-2146	3820815	18-2337	3850814
43FBPBYC	1998	18-2339	3852384	18-2146	3820815	18-2337	3850814
43FBPLKD	1997	18-2339	3852384	18-2146	3820815	18-2337	3850814
43FBPNCS	1996	18-2339	3852384	18-2146	3820815	18-2337	3850814
50FBPBYC	1998	18-2339	3852384	18-2146	3820815	18-2337	3850814
50FACPMDA	1994	18-2339	3852384	18-2146	3820815	18-2337	3850814
50FACPMDM	1994	18-2339	3852384	18-2146	3820815	18-2337	3850814

APLICACIÓN CONTINUA EN LA SIGUIENTE PÁGINA

① Used where raw w/p is located on outdrive ② Used where raw w/p is located on engine ③ Excluye modelo 58FBPMDA, used where raw w/p is located on engine
 ④ Used where raw w/p is located on engine, incl. Model 58FBPMDA

Modelo	Año	Cruceta Cardán #	Cardan. OE #	Eje largo #	Eje largo OE #	Eje corto #	Eje corto OE #
50FAGPMDA	1994	18-2339	3852384	18-2146	3820815	18-2337	3850814
50FAGPMDM	1994	18-2339	3852384	18-2146	3820815	18-2337	3850814
50FAPHUB	1995	18-2339	3852384	18-2146	3850815	18-2337	3850814
50FAPHUE	1995	18-2339	3852384	18-2146	3850815	18-2337	3850814
50FAPNCA	1996	18-2339	3852384	18-2146	3820815	18-2337	3850814
50FAPNCS	1996	18-2339	3852384	18-2146	3820815	18-2337	3850814
50FBPBYC	1998	18-2339	3852384	18-2146	3820815	18-2337	3850814
57FAPLKD	1997	18-2339	3852384	18-2146	3850815	18-2337	3850814
57FAPNCA	1996	18-2339	3852384	18-2146	3850815	18-2337	3850814
57FAPNCS	1996	18-2339	3852384	18-2146	3850815	18-2337	3850814
57FCPBYC	1998	18-2339	3852384	18-2146	3820815	18-2337	3850814
57FCPBYD	1998	18-2339	3852384	18-2146	3820815	18-2337	3850814
57FCPLKD	1997	18-2339	3852384	18-2146	3850815	18-2337	3850814
57FDPLKD	1997	18-2339	3852384	18-2146	3850815	18-2337	3850814
58FACPMDA	1994	18-2339	3852384	18-2146	3820815	18-2337	3850814
58FACPMDM	1994	18-2339	3852384	18-2146	3820815	18-2337	3850814
58FAGPMDA	1994	18-2339	3852384	18-2146	3820815	18-2337	3850814
58FAGPMDM	1994	18-2339	3852384	18-2146	3820815	18-2337	3850814
58FAPHUB	1995	18-2339	3852384	18-2146	3820815	18-2337	3850814
58FAPHUE	1995	18-2339	3852384	18-2146	3820815	18-2337	3850814
58FBDMDA	1994	18-2339	3852384	18-2146	3820815	18-2337	3850814
58FBPHUB	1995	18-2339	3852384	18-2146	3820815	18-2337	3850814
58FBPHUE	1995	18-2339	3852384	18-2146	3820815	18-2337	3850814
58FBPNCA	1996	18-2339	3852384	18-2146	3820815	18-2337	3850814
58FBPMDA	1994	18-2339	3852384	18-2146	3820815	18-2337	3850814
58FCPNCA	1996	18-2339	3852384	18-2146	3820815	18-2337	3850814
58FCPNCS	1996	18-2339	3852384	18-2146	3820815	18-2337	3850814
74FEPHUB	1995	18-2339	3852384	18-2146	3820815	18-2337	3850814
74FFPNCA	1996	18-2339	3852384	18-2146	3850815	18-2337	3850814
74FGPLKD	1997	18-2339	3852384	18-2146	3820815	18-2337	3850814
74FGPNCS	1996	18-2339	3852384	18-2146	3850815	18-2337	3850814
74FHPYC	1998	18-2339	3852384	18-2146	3820815	18-2337	3850814
74FHPBYC	1998	18-2339	3852384	18-2146	3820815	18-2337	3850814
74FJPBYC	1998	18-2339	3852384	18-2146	3820815	18-2337	3850814
74FJPYC	1998	18-2339	3852384	18-2146	3820815	18-2337	3850814
74FJPBYD	1998	18-2339	3852384	18-2146	3820815	18-2337	3850814
74FJPYD	1998	18-2339	3852384	18-2146	3820815	18-2337	3850814
82FCPBYC	1998	18-2339	3852384	18-2146	3820815	18-2337	3850814
302CCPMDA	1994	18-2339	3852384	18-2146	3820815	18-2337	3850814
302CGPMDA	1994	18-2339	3852384	18-2146	3820815	18-2337	3850814
302CMBYC	1998	18-2339	3852384	18-2146	3820815	18-2337	3850814
302CMBYM	1998	18-2339	3852384	18-2146	3820815	18-2337	3850814
302CMHUB	1995	18-2339	3852384	18-2146	3820815	18-2337	3850814
302CMLKD	1997	18-2339	3852384	18-2146	3850815	18-2337	3850814
302CMNCA	1996	18-2339	3852384	18-2146	3820815	18-2337	3850814
302CMNCS	1996	18-2339	3852384	18-2146	3820815	18-2337	3850814
302CPBYC	1998	18-2339	3852384	18-2146	3820815	18-2337	3850814
302CPBYM	1998	18-2339	3852384	18-2146	3820815	18-2337	3850814
302CPHUB	1995	18-2339	3852384	18-2146	3820815	18-2337	3850814
302CPLKD	1997	18-2339	3852384	18-2146	3850815	18-2337	3850814
302CPNCA	1996	18-2339	3852384	18-2146	3820815	18-2337	3850814
302CPNCS	1996	18-2339	3852384	18-2146	3820815	18-2337	3850814
302DCMMDA	1994	18-2339	3852384	18-2146	3820815	18-2337	3850814
302DGMMDA	1994	18-2339	3852384	18-2146	3820815	18-2337	3850814
432ACMMDA	1994	18-2339	3852384	18-2146	3820815	18-2337	3850814
432ACPMDA	1994	18-2339	3852384	18-2146	3820815	18-2337	3850814
432AGMMDA	1994	18-2339	3852384	18-2146	3820815	18-2337	3850814
432AGPMDA	1994	18-2339	3852384	18-2146	3820815	18-2337	3850814
432AFNCA	1996	18-2339	3852384	18-2146	3820815	18-2337	3850814
432BPLKD	1997	18-2339	3852384	18-2146	3820815	18-2337	3850814

STERNDRIVE/COBRA - Sistema transmisión
OMC

APLICACIONES CONTINÚAN EN LA SIGUIENTE PÁGINA

- ① Used where raw w/p is located on outdrive ② Used where raw w/p is located on engine ③ Excluye Modelo 58FBPMDA, used where raw w/p is located on engine
④ Used where raw w/p is located on engine, incl. Modelo 58FBPMDA

Modelo	Año	Cruceta Cardán #	Cardan. OE #	Eje largo #	Eje largo OE #	Eje corto #	Eje corto OE #
432BPNCs	1996	18-2339	3852384	18-2146	3820815	18-2337	3850814
502APHUB	1995	18-2339	3852384	18-2146	3820815	18-2337	3850814
502APHUE	1995	18-2339	3852384	18-2146	3820815	18-2337	3850814
432ACMMDA	1994	18-2339	3852384	18-2146	3820815	18-2337	3850814
432ACPMDA	1994	18-2339	3852384	18-2146	3820815	18-2337	3850814
432AGMMDA	1994	18-2339	3852384	18-2146	3820815	18-2337	3850814
432AGPMDA	1994	18-2339	3852384	18-2146	3820815	18-2337	3850814
432BPBYC	1998	18-2339	3852384	18-2146	3820815	18-2337	3850814
432BPLKD	1997	18-2339	3852384	18-2146	3820815	18-2337	3850814
434APNCA	1996	18-2339	3852384	18-2146	3820815	18-2337	3850814
434BPBYC	1998	18-2339	3852384	18-2146	3820815	18-2337	3850814
434BPLKD	1997	18-2339	3852384	18-2146	3820815	18-2337	3850814
434BPNCs	1996	18-2339	3852384	18-2146	3820815	18-2337	3850814
502ACPMDA	1994	18-2339	3852384	18-2146	3820815	18-2337	3850814
502AGPMDA	1994	18-2339	3852384	18-2146	3820815	18-2337	3850814
502APHUB	1995	18-2339	3852384	18-2146	3850815	18-2337	3850814
502APHUE	1995	18-2339	3852384	18-2146	3850815	18-2337	3850814
502APNCA	1996	18-2339	3852384	18-2146	3820815	18-2337	3850814
502APNCs	1996	18-2339	3852384	18-2146	3820815	18-2337	3850814
502BPBYC	1998	18-2339	3852384	18-2146	3820815	18-2337	3850814
572ACPMDA	1994	18-2339	3852384	18-2146	3820815	18-2337	3850814
572AGPMDA	1994	18-2339	3852384	18-2146	3820815	18-2337	3850814
572BPBYC	1998	18-2339	3852384	18-2146	3820815	18-2337	3850814
572BPLKD	1997	18-2339	3852384	18-2146	3820815	18-2337	3850814
572BPLKR	1997	18-2339	3852384	18-2146	3820815	18-2337	3850814
572BPNCs	1996	18-2339	3852384	18-2146	3820815	18-2337	3850814
574BPLKD	1997	18-2339	3852384	18-2146	3820815	18-2337	3850814
584ACPMDA	1994	18-2339	3852384	18-2146	3820815	18-2337	3850814
584AGPMDA	1994	18-2339	3852384	18-2146	3820815	18-2337	3850814
584APHUB	1995	18-2339	3852384	18-2146	3820815	18-2337	3850814
584APHUE	1995	18-2339	3852384	18-2146	3820815	18-2337	3850814
584APNCA	1996	18-2339	3852384	18-2146	3820815	18-2337	3850814
584APNCs	1996	18-2339	3852384	18-2146	3820815	18-2337	3850814
744DCPMDM	1994	18-2339	3852384	18-2146	3820815	18-2337	3850814
744DCPMDA	1994	18-2339	3852384	18-2146	3820815	18-2337	3850814
744DDPMDA	1994	18-2339	3852384	18-2146	3820815	18-2337	3850814
744DDPMDM	1994	18-2339	3852384	18-2146	3820815	18-2337	3850814
744DGPMDA	1994	18-2339	3852384	18-2146	3820815	18-2337	3850814
744DGPMDM	1994	18-2339	3852384	18-2146	3820815	18-2337	3850814
744DJPMDA	1994	18-2339	3852384	18-2146	3820815	18-2337	3850814
744DJPMDM	1994	18-2339	3852384	18-2146	3820815	18-2337	3850814
744DPHUB	1995	18-2339	3852384	18-2146	3820815	18-2337	3850814
744EPNCA	1996	18-2339	3852384	18-2146	3850815	18-2337	3850814
744FPLKD	1997	18-2339	3852384	18-2146	3850815	18-2337	3850814
744FPNCs	1996	18-2339	3852384	18-2146	3850815	18-2337	3850814

- ① Used where raw w/p is located on outdrive ② Used where raw w/p is located on engine
 ③ Excludes Model 58FBDPMDA, used where raw w/p is located on engine ④ Used where raw w/p is located on engine, incl. Model 58FBDPMDA

18-2772-1
KIT TRANSOM
 Para: Drives SX Cobra con embrague cónico



— CONTIENE —

Ref #	Descripción	O.E. #	Cant.
18-2100	Cojinete	3853807	1
18-2765	Fuelle	3854127	1
18-1074	Fuelle	3850426-2	1
18-2996	Retén	3852560, 911823	1
18-710-64-2	Abrazadera	853012-3	1

18-2771
KIT FUELLES
 Reemplaza: 3854270
 Para: OMC Cobra sin embrague cónico



— CONTIENE —

Ref #	Descripción	O.E. #
18-2613	Kit juntas	—
18-2765	Fuelle	983973, 987467
18-2764	Fuelle escape	914036
18-2763	Fuelle cable	911826
18-2100	Cojinete cardan	983937
18-710-64-2	Abrazadera	—

 <p>18-2128 SOPORTE CENTRAL Reemplaza: 912213, 3850813 Para todas las unidades OMC Cobra</p>	 <p>18-2745 TUBO ESCAPE Reemplaza: 912374 Para 5.7L & 7.5L (1986 & posteriores)</p>	 <p>18-1074 FUELLE ESCAPE D.I. 2 5/8" x O.D. 3" x L 7.5" Reemplaza: 3850426 Todos los modelos con acopla- miento cónico (1994-Sup) que no llevan tubo escape</p>	 <p>18-2763 FUELLE CABLE CAMBIO Reemplaza: 911826 TODOS COBRA</p>	 <p>18-1074 FUELLE ESCAPE Reemplaza: 914036 Para modelos Cobra (1986-93)</p>
-----------------------------------------------------------------------------------------------------------------------------------------------------------------------------------------------------------------	------------------------------------------------------------------------------------------------------------------------------------------------------------------------------------------------------------	---------------------------------------------------------------------------------------------------------------------------------------------------------------------------------------------------------------------------------------------------------------------------------------------	------------------------------------------------------------------------------------------------------------------------------------------------------------------------------------------	-------------------------------------------------------------------------------------------------------------------------------------------------------------------------------------------

 <p>18-2765 CEF 18-2765S FUELLE TRANSMISIÓN D.I. 3 1/2" x O.D. 4" x L 6" Reemplaza: 983973, 987467, 3854127 Para modelos Cobra (1986-93)</p>	 <p>18-21754 DAMPER Reemplaza: 986232, 984537 Para: 7.5L / 460 King Cobra 1987-90</p>	 <p>18-21751 DAMPER Reemplaza: 3853962, 983902, 986338 Para: 2.5L (1986), 3.0L (1986-90), (4.3L, 5.0L, 5.7L) (1986) KW & KWB sólo sufijo, 7.4L (1990-98), 8.2L (1992-93, 1998)</p>	 <p>18-21752-1 DAMPER Reemplaza: 3858437, 984290, 986120, 3853917 Para: 4.3L (1986-98), 5.0L (1986-88, 1998) 5.7 (1986-92, 1994, 1996-98)</p>
----------------------------------------------------------------------------------------------------------------------------------------------------------------------------------------------------------------------------------------------------------------------------	--------------------------------------------------------------------------------------------------------------------------------------------------------------------------------------------------	----------------------------------------------------------------------------------------------------------------------------------------------------------------------------------------------------------------------------------------------------------------------------------------------------------------	--------------------------------------------------------------------------------------------------------------------------------------------------------------------------------------------------------------------------------------------------------------------

 <p>18-21753 DAMPER Reemplaza: 3853862 Para: 5.0L & 5.8L (1989-96)</p>	 <p>18-21755 DAMPER Reemplaza: 984629 2.3L Cobra</p>	 <p>18-2533 RETÉN TRANSOM Reemplaza: 911797</p>	 <p>18-2767 RETÉN TRANSOM 16 manguera Reemplaza: 313080 (1967-77) 120 HP y SUP</p>
-----------------------------------------------------------------------------------------------------------------------------------------------------------------------------------------	-------------------------------------------------------------------------------------------------------------------------------------------------------------------	-----------------------------------------------------------------------------------------------------------------------------------------------------------	-------------------------------------------------------------------------------------------------------------------------------------------------------------------------------------------------------

 <p>18-2768 RETÉN TRANSOM 22 manguera Reemplaza: 909527 (1978-86) — Todos</p>	 <p>18-2246 CONJUNTO CABLE INVERSOR Reemplaza: 987678 Cables: 59" Para: King Cobra</p>	 <p>18-2245-1 CONJUNTO CABLE INVERSOR Reemplaza: 987661 Cable: 68" • Funda: 58 1/2" Para: 1988-1993 OMC Cobra (excepto King) Sin el embrague cónico</p>
------------------------------------------------------------------------------------------------------------------------------------------------------------------------------------------------	---------------------------------------------------------------------------------------------------------------------------------------------------------------------------------------------------------	--------------------------------------------------------------------------------------------------------------------------------------------------------------------------------------------------------------------------------------------------------------------------------

 <p>18-2176 ENGRANAJE (Aloj.intermedio) Reemplaza: 908063 (1973-86)</p>	 <p>18-2177 ENGRANAJE (Aloj.superior) Reemplaza: 908069 1973-86</p>	 <p>18-3769 TUERCA PIÑÓN Reemplaza: 911753 Para: 115 (1994-97), 232 (1987-90), 252 (1986), 262, 350, 460 (1989), 302, 574 (1986-92), 432 (1986-93), 502 (1988-93), 504, 754 (1986-88), ,584 (1989-93), 744 (1988), 90 Jet (1994-95)</p>	 <p>18-3719 TUERCA PIÑÓN Reemplaza: 314730 (5/8 - 18)</p>	
<p>PACK. DE 5</p>  <p>18-3725 18-3725-9① TUERCA Reemplaza: 908064</p>	<p>PACK. DE 2</p>  <p>18-3731 18-3731-9① TUERCA Reemplaza: 907866 3/4 - 16</p>	<p>PKG. OF 5</p>  <p>18-4251 18-4251-9① TAPÓN Reemplaza: 908062 O.D. 1.748</p>	 <p>18-4835 CONO Reemplaza: 912029 Para: OMC Cobra (1986-93) sin acoplamiento cónico</p>	 <p>18-1154 COJINETE A BOLAS Reemplaza: 377139</p>
 <p>18-1161 COJINETE Reemplaza: 983891</p>	 <p>18-1170 COJINETE PIÑÓN INFERIOR Reemplaza: 983892</p>	 <p>18-1171 COJINETE TRANSMISIÓN Reemplaza: 983878</p>	 <p>18-1172 COJINETE Reemplaza: 983877 Para: 1986-95 Cobra</p>	 <p>18-1750 COJINETE COMPLETO ALOJAMIENTO Para: Cobra y V6</p>
 <p>18-1158 COJINETE Reemplaza: 387247</p>	 <p>18-1350 COJINETE Reemplaza: 379504</p>	 <p>18-1351 COJINETE Reemplaza: 382407 COBRA</p>	 <p>18-1117 COJINETE PIÑÓN Reemplaza: 387817</p>	 <p>18-1357 COJINETE PIÑÓN Reemplaza: 384195 COBRA</p>
 <p>18-1358 COJINETE ENGRANA- JE REVERSO Reemplaza: 389039 COBRA</p>	 <p>18-1365 COJINETE EMPUJE Reemplaza: 387656 COBRA EJE TRANSMISIÓN</p>	 <p>18-1366 COJINETE EMPUJE Reemplaza: 382408 COBRA ENGRANAJE REVERSO</p>	 <p>18-1370 COJINETE EMPUJE ENGRANAJE AVANTE Reemplaza: 389042</p>	 <p>18-1371 COJINETE EMPUJE AVANTE Reemplaza: 385043 COBRA</p>

① Precio por pack

SERIES OMC 400 & 800 COJINETES CAJA ENGRANAJES

HP	Año	Cojinete piñón	Cojinete transmisión	Cojinete Diabolo	Cojinete diabolo externo	Cojinete Empuje avante	Cojinete empuje Reverso	Alojamiento Cojinete
120	1978-81	18-1357	18-1365	18-1350	18-1351	18-1371	18-1366	—
2.5L	1982-86	18-1357	18-1365	18-1350	18-1351	18-1371	18-1366	18-1351
140	1978-81	18-1357	18-1365	18-1350	18-1351	18-1371	18-1366	—
3.0L	1982-86	18-1357	18-1365	18-1350	18-1351	18-1371	18-1366	18-1351
185/3.8L	1978-85	18-1117	18-1365	18-1158	18-1351	18-1370	18-1366	18-1358
4.3L	1985-86	18-1117	18-1365	18-1158	18-1351	18-1370	18-1366	18-1358
200/5.0L	1979-86	18-1117	18-1365	18-1158	18-1351	18-1370	18-1366	18-1358
225	1978	18-1117	18-1365	18-1158	18-1351	18-1370	18-1366	18-1358
230/530L	1979-86	18-1117	18-1365	18-1158	18-1351	18-1370	18-1366	18-1358
240	1978	18-1117	18-1365	18-1158	18-1351	18-1370	18-1366	18-1358
250	1979	18-1117	18-1365	18-1158	18-1351	18-1370	18-1366	18-1358
260/5.7L	1979-86	18-1117	18-1365	18-1158	18-1351	18-1370	18-1366	18-1358

OMC COBRA COJINETES

Modelo	Litro	Año	Cojinete piñón	Cojinetes transmisión	Cojinete diabolo	Cojinete diabolo Externo	Cojinete empuje avante	Cojinete empuje reverso	Alojamiento Cojinete
2.3L	2.3L	1987	18-1357	18-1365	18-1350	18-1351	18-1371	18-1366	18-1351
2.3L	2.3L	1988-1990	18-1357	18-1365	18-1350	18-1351	18-1371	18-1366	N/D
2.5L	2.5L	1986	18-1357	18-1365	18-1350	18-1351	18-1371	18-1366	18-1351
3.0L	3.0L	1986-1987	18-1357	18-1365	18-1350	18-1351	18-1371	18-1366	18-1351
3.0L	3.0L	1988-1989	18-1357	18-1365	18-1350	18-1351	18-1371	18-1366	N/D
3.0L	3.0L	1990-1991	18-1117	18-1365	18-1158	18-1351	18-1370	18-1366	N/D
3.0L	3.0L	1992-1993	18-1117	18-1365	N/D	18-1351	18-1370	18-1366	N/D
3.0L HO	3.0L	1992-1993	18-1117	18-1365	N/D	18-1351	18-1370	18-1366	N/D
4.3L	4.3L	1986-1987	18-1117	18-1365	18-1158	18-1351	18-1370	18-1366	18-1358
4.3L	4.3L	1988-1991	18-1117	18-1365	18-1158	18-1351	18-1370	18-1366	N/D
4.3L	4.3L	1992-1993	18-1117	18-1365	N/D	18-1351	18-1370	18-1366	N/D
4.3L HO	4.3L	1992-1993	18-1117	18-1365	N/D	18-1351	18-1370	18-1366	N/D
5.0L	5.0L	1986-1987	18-1117	18-1365	18-1158	18-1351	18-1370	18-1366	18-1358
5.0L	5.0L	1988-1991	18-1117	18-1365	18-1158	18-1351	18-1370	18-1366	N/D
5.0L	5.0L	1992-1993	18-1117	18-1365	N/D	18-1351	18-1370	18-1366	N/D
5.0L HO	5.0L	1992-1993	18-1117	18-1365	N/D	18-1351	18-1370	18-1366	N/A
5.7L	5.7L	1986-1987	18-1117	18-1365	18-1158	18-1351	18-1370	18-1366	18-1358
5.7L	5.7L	1988-1991	18-1117	18-1365	N/D	18-1351	18-1370	18-1366	N/D
5.7L	5.7L	1992-1993	18-1117	18-1365	N/D	18-1351	18-1370	18-1366	N/D
5.8L	5.8L	1989-1991	18-1117	18-1365	N/D	18-1351	18-1370	18-1366	N/D
5.8L	5.8L	1992-1993	18-1117	18-1365	N/D	18-1351	18-1370	18-1366	N/D



18-0195
ARANDELA EMPUJE
Reemplaza: 314731
COBRA



18-0198
ARANDELA DE EMPUJE
Reemplaza: 324766

PACK. DE 2



18-2243
18-2243-9^①
BOLA RETENCIÓN
Reemplaza: 316506
Para: Caja engranajes V-4 & V-6 OMC colas 400 Series (1978-79); 800 Series (1978)



18-1501
BOLA RETENCIÓN
Reemplaza: 160084
Para: Colas Cobra (1980& anteriores)



18-1732
RETENEDOR EJE TRANSMISIÓN
Reemplaza: 338504
Para: eje transmisión V4 & V6



18-1701
EJE INFERIOR TRANSMISIÓN
Reemplaza: 911693
Para: Colas Cobra 262, 302, 350, 432, 434, 502, 504, 574, 584



18-2183
EJE TRANSMISIÓN
Reemplaza: 909121

① Precio por pack



18-2184
EJE TRANSMISIÓN
Reemplaza: 908087



18-2185
EJE TRANSMISIÓN
Reemplaza: 909753



18-2186
EJE TRANSMISIÓN
Reemplaza: 982424
800 transmisión



18-2187
EJE HÉLICE
Reemplaza: 395209
Cobra & últimos modelos transmisión
800



18-2251
EJE HÉLICE
Reemplaza: 435022, 433017, 436740



18-2252
EJE HÉLICE
Reemplaza: 387818, 436888



18-2216
PIÑÓN EMBRAGUE
Reemplaza: 337772, 337774,
334516, 336562, 910995



18-2220
PIÑÓN EMBRAGUE
Reemplaza: 323664, 320630



18-2383
PIÑÓN EMBRAGUE
Reemplaza: 914716, 915272
Para: 3.0L (GM), 4.3L (GM), 5.0L (Ford), 5.7L (Ford),
5.8L (Ford) (1990-91)



18-2218
PIÑÓN MARCHA ADELANTE
Reemplaza: 434063, 987966,
985050, 436746



18-2219
PIÑÓN MARCHA ATRAS
Reemplaza: 333077,
317838, 340490



18-1600
KIT SUPERIOR ENGRANAJE
con cojinete
Reemplaza: 983825
Para: 5.7, 5.8L V-8 Cobra transmisión (21:16 ratio)



18-1601
KIT ENGRANAJE SUPERIOR
con cojinete
Reemplaza: 983826
Para: Motor 5.0L V-8 -Cobra transmisión (21:18 ratio)



18-1602
KIT ENGRANAJES SUPERIOR
Reemplaza: 984012
Para: 4.3L V-6 motor-Cobra transmisión (21:19 ratio)

APLICACIONES EJES/ENGRANAJES

Modelo	Año	Cojinete soporte eje	Eje bomba agua corto/largo	Eje transmisión	Eje hélice	Engranaje Avante	Engranaje Reverso	Embrague deslizante
100 hasta 165	1973	—	18-2185	—	—	—	—	—
120 hasta 190	1974-75	—	18-2185	—	—	—	—	—
120 hasta 235 ⑥	1976-77	—	18-2184	—	—	—	—	—
120 hasta 190 ⑤	1976	—	18-2185	—	—	—	—	—
120/140 ⑤	1977	—	18-2185	—	—	—	—	—
120/140	1978-81	18-2183	18-2185	—	18-2252	—	—	18-2220
120 hasta 235 ⑥	1977	—	18-2184	—	—	—	—	—
175/190/235 ⑤	1977	18-2183	18-2185	—	—	—	—	—
185	1978	18-2183	18-2185	18-2186	—	—	—	—
185	1980-81	18-2183	18-2185	18-2186	—	—	—	—
200	1979	18-2183	18-2185	18-2186	—	—	—	—
200	1980-81	18-2183	18-2185	18-2186	—	—	—	—
225/245	1973-75	—	18-2184	—	—	—	—	—
225	1978	18-2183	18-2185	18-2186	—	—	—	—
225	1979	—	—	18-2186	—	—	—	—
225	1980	—	—	18-2186	—	—	—	—
225	1981	—	—	18-2186	—	—	—	—
230	1979	18-2183	18-2185	18-2186	—	—	—	—
230	1980-81	18-2183	18-2185	18-2186	—	—	—	—
235	1975	18-2183	18-2185	—	—	—	—	—
235 ⑤	1976-77	18-2183	18-2185	—	—	—	—	—
240	1978	18-2183	18-2185	18-2186	—	—	—	—
240	1979	—	—	18-2186	—	—	—	—
240	1980-81	—	—	18-2186	—	—	—	—
250	1979	18-2183	18-2185	18-2186	—	—	—	—
260	1979	18-2183	18-2185	18-2186	—	—	—	—
260	1980-81	18-2183	18-2185	—	—	—	—	—
262	1989	—	—	—	18-2187	—	—	—
2.3/3.0	1987-89	—	—	—	18-2252	—	18-2219	—
2.3	1990	—	—	—	18-2252	—	—	—
2.5	1986	18-2183	18-2185	—	18-2252	—	18-2219	—
2.5	1982-87	18-2183	18-2185	—	18-2252	18-2218	18-2219	—
350 ③	1988-89	—	—	—	18-2187	18-2218	—	—
3 ①	1982-86	18-2183	18-2185	—	18-2252	18-2218	18-2219	18-2216
3.0/4.3 ③	1990-91	—	—	—	18-2187	—	—	18-2383
3.0/4.3	1992-93	—	—	—	18-2251	—	—	18-2383
3.0 H.O.	1990-91	—	—	—	18-2187	—	—	18-2383
3.0 H.O.	1992-93	—	—	—	18-2251	—	—	18-2383
3.8	1982-86	18-2183	18-2185	18-2186	18-2187	—	—	18-2216
460 ③	1988-89	—	—	—	18-2187	—	—	18-2216
4.3 ①	1985-86	18-2183	18-2185	18-2186	18-2187	—	—	18-2216
4.3 ②	1986-87	—	—	—	18-2187	—	—	—
4.3 ③	1988-91	—	—	—	18-2187	—	—	18-2383 ⑨
4.3 H.O.	1990-91	—	—	—	18-2187	—	—	18-2383
4.3 H.O.	1992-93	—	—	—	18-2251	—	—	18-2383
5.0/5.7	1982-83	18-2183	18-2185	18-2186	—	—	—	18-2216
5.0/5.7 ①	1984-86	18-2183	18-2185	18-2186	18-2187	—	—	18-2216
5 ②	1986-87	—	—	—	18-2187	—	—	—
5	1988	—	—	—	18-2187	—	—	—
5 ③	1988-91	—	—	—	18-2187	—	—	18-2383 ⑨
5.0/5.7	1992	—	—	—	18-2251	—	—	18-2383
5.0 H.O.	1990-91	—	—	—	18-2187	—	—	18-2383
5.0 H.O.	1992-93	—	—	—	18-2251	—	—	18-2383
5.7	1987-88	—	—	—	18-2187	—	—	—
5.7 ③	1988-89	—	—	—	18-2187	—	—	—
5.7 ⑧ ③	1990-92	—	—	—	18-2187	—	—	18-2383
5.8 ③	1989-90	—	—	—	18-2187	—	—	18-2383 ⑨
5.8	1991	—	—	—	18-2187	—	—	18-2383
5.8	1992-93	—	—	—	18-2251	—	—	18-2383
7.5	1987	—	—	—	18-2187	—	—	18-2216

① Excepto Cobra
② Cobra

③ Rotación derecha
⑤ Perfil bajo

⑥ Perfil alto
⑧ Excepto modelos L.E

⑨ Sólo modelos 1990-93



**18-1702
RODILLO DIABOLO**
Reemplaza: 438039, 5000074
Para: 1 3/16" diámetro eje-Cobra transmisión (1986-90) Para montajes stringer 2.5L & 3.0L (1978-85)



**18-1703
RODILLO DIABOLO**
Reemplaza: 434400, 435096, 438040, 5000363, 5004257
Para: 1 1/4" diámetro eje hélice Cobra transmisión (1991-93)



18-4828
COJINETE PIÑÓN
 Reemplaza: 911750
 Para: OMC Cobra (1986-93) sin alojamiento cónico



18-1099
ALOJAMIENTO COJINETE
 Reemplaza: 982422
 Para: Colas OMC Stringer-120, 140, 170, 200, 230, 260, (1981), 252, 302, 382, 502, 504 & 574 (1982-85), 432 (1985)



18-1343
COJINETE RETENEDOR
 Reemplaza: 333957
 Para: Cobra transmisión & V-6



18-0655
VARILLA DE CAMBIO
 Reemplaza: 914736
 3.0L (1990-1993), 4.3L, 5.0L, 5.7L, 5.8L (1986-1993)



18-0647
VARILLA DE CAMBIO
 Reemplaza: 986658
 3.0L (1990-1993), 4.3L, 5.0L, 5.7L, 5.8L (1986-1993)



18-0652
TERMINAL VARILLA DE CAMBIO
 Reemplaza: 914723
 3.0L (1990-1993), 4.3L, 5.0L, 5.7L, 5.8L (1986-1993)



18-0653
TORNILLO, VARILLA CAMBIO
 Reemplaza: 308825
 3.0L (1990-1993), 4.3L, 5.0L, 5.7L, 5.8L (1986-1993)



18-0654
TUERCA, VARILLA CAMBIO
 Reemplaza: 914743
 3.0L (1990-1993), 4.3L, 5.0L, 5.7L, 5.8L (1986-1993)



18-3766
BASE CAMBIO
 Reemplaza: 334163
 Para: V-4/V-6, Cobra, Stringer



18-3610
TUERCA RETENEDOR
 Reemplaza: 911752
 Para: OMC Cobra (1986-93) sin alojamiento cónico



18-3768
TUERCA TAPA
 Reemplaza: 911751
 Para: Colas Cobra 115 (1994-97), 232 (1987-90), 252 (1986) 262 (1989), 302 (1987)



18-1500
REJILLA ADMISIÓN
 Reemplaza: 337778
 Para: 100, 120, 125, 140, 150, 175, 200, 225 (1993) (OMC Cobra & V6)



18-4750
TAPA
 Reemplaza: 983967
 Para: 2.3L (1987-90), 2.5L (1986), 2.6L (1989), 3.0L (1986-93), 4.3L (1986-93), 5.0L (1986-94), 5.7L (1986-92), 5.8L (1989-93), 7.4L (1988)



18-1714
PASADOR
 Reemplaza: 313448
 Para: 50-85, 100, 135, 140, 150, 175, 200, 235 (1969-82) (OMC Stringer transmisión)



18-2399
MUELLE TRINQUETE
Reemplaza: 324369
Para: V-4 & V-6



18-4222
ARANDELA
Reemplaza: 318841



18-4223
ARANDELA
Reemplaza: 333592



18-4228
ESPACIADOR HÉLICE
Reemplaza: 315810



18-4194
ESPACIADOR HÉLICE
Reemplaza: 3852350
Para: 1994 King Cobra Unidades inferiores



18-4231
ESPACIADOR HÉLICE
Reemplaza: 320570

PKG. OF 5



18-3705
18-3705-9①
TUERCA HÉLICE
Reemplaza: 314503



18-3708-1
TUERCA HÉLICE Y RETENEDOR
Reemplaza: 398042



18-3730
TUERCA MONTAJE FUERABORDA
Reemplaza: 3852648
Para: Cobra & King Cobra 1987-94

② **18-3733D** 



18-3733
KIT TUERCAS HÉLICE
Para: SX Cobra

② **18-3715D** 



18-3715
KIT TUERCAS HÉLICE
- CONTIENE -

Ref #	O.E. #	Descripción
18-3708-1	398042	tuerca hélice/Retenedor
18-3741	309955	Aguja
18-4231	320570	Espaciador hélice

② **18-3716D** 



18-3716
KIT TUERCAS HÉLICE
Reemplaza: 175267
- CONTIENE -

Ref #	O.E. #	Descripción
18-3705	314503	Tuerca hélice
18-3742	314502	Aguja
18-4238	315810	Espaciador hélice



18-4444
LLAVE HÉLICE
TODO LOS COBRA



18-2156
EJE DE TILT
Reemplaza: 980183
I/O 1964-86
EXCEPTO COBRA

PKG. OF 10





PASADORES

18-3741	18-3742
18-3741-9①	18-3742-9①
Reemplaza:	Reemplaza:
309955	314502

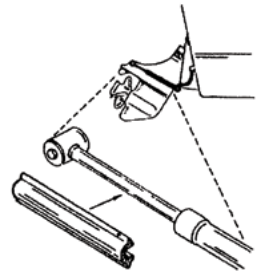

18-9098
BLOQUEADOR COLA
Reemplaza: 174448
juego de 2
Para todas las transmisiones Cobra





APLICACIONES EMPIEZAN EN LA PRÓXIMA PÁGINA

① Precio por pack

② Las referencias acabadas en "D" son envasadas en blister - referencias normales no envasadas

TUERCA/ESPACIADOR/ARANDELA/PASADOR/APLICACIÓN TUERCA

Modelo	Año	Tuerca	Espaciador	Arandela	Aguja Pasador	Kit tuerca hélice	Modelo	Año	Tuerca	espaciador	Arandela	Aguja Pasador	Kit Tuerca
120	1978-81	18-3705	18-4228	18-4222	18-3742	18-3716	460	1989-90	18-3708-1	18-4231	18-4223	18-3741	18-3715
140	1978-81	18-3705	18-4228	18-4222	18-3742	18-3716	502	1992	18-3708-1	18-4231	18-4223	18-3741	18-3715
185	1978-80	18-3708-1	18-4231	18-4223	18-3741	18-3715	2.3	1987-90	18-3705	18-4228	18-4222	18-3742	18-3716
200	1979-81	18-3708-1	18-4231	18-4223	18-3741	18-3715	2.5	1982-86	18-3705	18-4228	18-4222	18-3742	18-3716
225	1978	18-3708-1	18-4231	18-4223	18-3741	18-3715	3	1982-89	18-3705	18-4228	18-4222	18-3742	18-3716
230	1979	18-3708-1	18-4231	18-4223	18-3741	18-3715	3	1990-92	18-3708-1	18-4231	18-4223	18-3741	18-3715
240	1978	18-3708-1	18-4231	18-4223	18-3741	18-3715	3.8	1981-85	18-3708-1	18-4231	18-4223	18-3741	18-3715
260	1979-81	18-3708-1	18-4231	18-4223	18-3741	18-3715	4.3	1985-92	18-3708-1	18-4231	18-4223	18-3741	18-3715
262	1987-89	18-3708-1	18-4231	18-4223	18-3741	18-3715	5	1982-92	18-3708-1	18-4231	18-4223	18-3741	18-3715
350	1988-91	18-3708-1	18-4231	18-4223	18-3741	18-3715	5.7	1979-92	18-3708-1	18-4231	18-4223	18-3741	18-3715
351	1992	18-3708-1	18-4231	18-4223	18-3741	18-3715	5.8	1989-92	18-3708-1	18-4231	18-4223	18-3741	18-3715
454	1990-92	18-3708-1	18-4231	18-4223	18-3741	18-3715	7.5	1987	18-3708-1	18-4231	18-4223	18-3741	18-3715

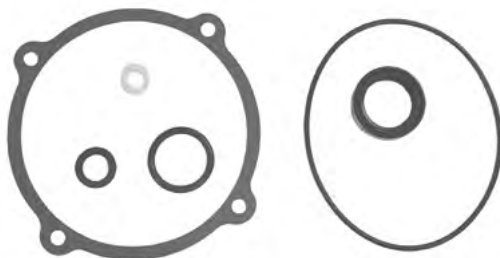

18-2698
KIT RETENES ALOJAMIENTO EMBRAGUE
Para: todos modelos 1977 e inferiores

— CONTIENE —

Ref #	Desc.	O.E. #	Cant.
18-7114	ARO TÓRICO	302540	1
18-7400	ARO TÓRICO	908194	1
18-7952	RETÉN ACEITE	911019	1
18-2863	JUNTA TAPA	308799	1
18-4248	ARANDELA	311598	1
18-0939	JUNTA CAJA ENGRANAJES SUPERIOR	315189	1



18-8360
KIT RETENES ALOJAMIENTO EMBRAGUE
Para: Todos modelos 1978 & superiores

— CONTIENE —

Ref #	Desc.	O.E. #	Cant.
18-2060	RETÉN ACEITE	321467	2
18-7114	ARO TÓRICO	302540	1
18-7168	ARO TÓRICO	202893	2
18-7400	ARO TÓRICO	908194	1
18-2863	JUNTA TAPA	308799	1
18-4248	ARANDELA	311598	2
18-0939	JUNTA CAJA ENGRANAJES SUPERIOR	315189	1

HP	Año	Kit Retenes	HP	Año	Kit Retenes	HP	Año	Kit Retenes	HP	Año	Kit Retenes
80	1968-1969	18-2698	140	1980-1981	18-8360③	190	1974-1977	18-2698	230	1980-1981	18-8360②
90	All	18-2698	3.0L	1982-1985	18-8360	200	1966-1968	18-2698	235	Todos	18-2698
100	1972-1973	18-2698	155	1967-1972	18-2698	200	1979-1980	18-2698①	240	1978	18-2698
120	1965-1978	18-2698	165	1972-1976	18-2698	200	1980-1981	18-8360②	245	1972-1975	18-2698
120	1979-1980	18-2698①	3.8L	1981-1983	18-8360	5.0L	1982-1985	18-8360	250	1979	18-2698
120	1980-1985	18-8360③	170	1974	18-2698	210	1968-1970	18-2698	260	1979-1980	18-2698①
2.5L	1982-1985	18-8360	175	1975-1977	18-2698	215	1971	18-2698	260	1980-1981	18-8360②
140	1973-1978	18-2698	185	1967-1968	18-2698	225	Todos	18-2698	5.7L	1982-1985	18-8360
140	1979-1980	18-2698①	185	1978	18-2698	230	1979-1980	18-2698①			

① 1980 Modelos con sufijo "C" ② 1980 Modelos con sufijo "K" o "U" ③ 1980 Modelos con sufijo "C1"

El ZINC es solo para aplicaciones de agua salada.
El MAGNESIO es sólo para aplicaciones de agua dulce.
El ALUMINIO es para agua dulce como para salada.



⑤ **009366 Zinc**
ÁNODO
Reemplaza: 982277, 982438
Para alojamiento intermedio modelo Stringer



⑤ **009368 Zinc**
ÁNODO
Reemplaza: 976669



⑤ **025339 Zinc**
④ **603154 Al**
ÁNODO
Reemplaza: 393023, 436745
(1982-87) Para usar con caja engranajes



⑤ **009317 Zinc**
603132 Aluminio
ÁNODO
Reemplaza: 433458, 398331

④ Aluminio ⑤ Zinc



③ 009318 Zinc
603153 Aluminio
ÁNODO
Reemplaza: 392123
Para alojamiento escape,
V4 & V6 (1983-90)



③ 025840 Zinc
① 603130 Aluminio
② 18-6102 Magnesio
ÁNODO
Reemplaza: 984513,
3853818, 3855412
Para usar con caja engranaje: 2.3L (1987-90),
2.6L/3.5L/4.6L (1989), 3.0L /4.3L/5.0L/5.8L
(1987-93), 5.7L (1987-92), 7.4L (1987-88)



③ 18-6029 Zinc
603128 Aluminio
ÁNODO
Reemplaza: 397768



③ 025756 Zinc
① 603127 Aluminio
ÁNODO
Reemplaza: 431708
Para usar con caja engranaje (1988-90)



③ 009364 Zinc
603129 Aluminio
ÁNODO
Reemplaza: 983494
Para: Cobra unidades inferiores (1987)
2.5, 3.0, 4.3, 5.0, 5.7



③ 009367 Zinc
① 603131 Aluminio
ÁNODO
Reemplaza: 984547
Para usar con montaje Transom:
2.3L/3.0L (1987-89), 2.6L (1989)



009374
ÁNODO
Para colas OMC Cobra -5700.
Reemplaza: 987067/3854061



009469
ÁNODO
Para motores OMC-Cobra-Johnson y
Evinrude.
Reemplaza: 984513



025492
ÁNODO
Para colas OMC King Cobra
Reemplaza: 3854130

PKG. OF 5



18-3722
18-3722-9④
**TUERCAS APRIETE ACERO
INOXIDABLE**
Reemplaza: 121731
(1/4" - 28)



18-2454
TORNILLO DRENAJE
Reemplaza: 3854539
3/8" - 16 rosca
Usar aro tórico 18-7145
Para: Cobra SX drives



18-2138
COJINETE PIVOTE
Reemplaza: 911787
COBRA
(2 para COLA)



18-7634
TRANSMISOR TRIM
Reemplaza: 984748
Para: OMC Cobra



18-2663
KIT RETENES ENGRANAJE INFERIOR
 Reemplaza: 981797
 100-245 Stringer Unit (1968-77)

— CONTIENE —

Ref #	Desc.	O.E. #	Cant.
18-0168	Casquillo	908594	1
18-2012	Retén aceite	310599	4
18-2020	Retén aceite	310649	1
18-2058	Retén aceite	313353	2
18-2851	Junta aloj. inferior a cojinete transmisión	313368	1
18-4248	Arandela	311598	2
18-7120	Aro tórico	307853, 322598	4
18-7129	Aro tórico	314491	1
18-7135	Aro tórico	310584	1
18-7167	Aro tórico	310414	1

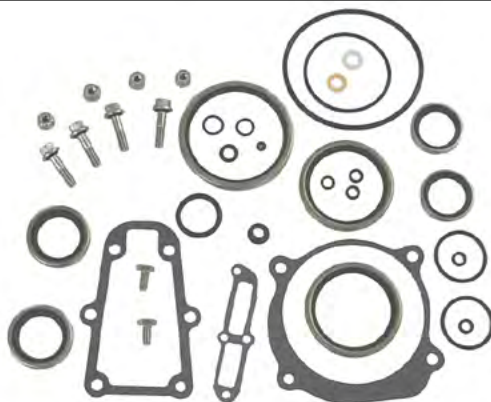

18-2664
KIT RETENES ENGRANAJE INFERIOR
 Reemplaza: 982947
 4 cil (400) Stringer Unit (1978-86)

— CONTIENE —

Ref #	Desc.	O.E. #	Cant.
18-0110	Junta alojamiento	324670	1
18-3133	Tornillo alojamiento	908158	2
18-0188	Arandela	909748	1
18-2020	Retén aceite	310649	1
18-2058	Retén aceite	313353	2
18-2060	Retén aceite	321467	2
18-3722	Tuerca apriete	121731	4
18-4248	Arandela	311598	2
18-7101	Aro tórico	305739	1
18-7102	Aro tórico	307450	1
18-7120	Aro tórico	307853, 322598	1
18-7127	Aro tórico	313446	1
18-7130	Aro tórico	314728	1
18-7178	Aro tórico	320140	1
18-7404	Aro tórico	909747	1
18-7475	Aro Quad	332583	4
18-7168	Aro tórico	202893	1
18-7409	Aro tórico	911871	2
18-2001	Retén aceite	330137	2
18-7479	Aro tórico	—	1
18-3153	Tornillo	908158	2

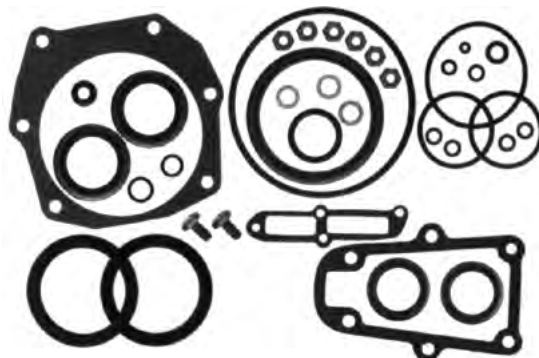

18-2665
KIT RETENES ENGRANAJE SUPERIOR
 Reemplaza: 982946
 V6,V8 (800) Stringer Unit (1978-86)

— CONTIENE —

Ref #	Desc.	O.E. #	Cant.
18-0110	Junta alojamiento	324670	1
18-3133	Tornillo alojamiento	908158	2
18-0188	Arandela	909748	1
18-2002	Retén aceite	320862	2
18-2020	Retén aceite	310649	1
18-2058	Retén aceite	313353	2
18-2060	Retén aceite	321467	2
18-2911	Junta alojamiento transmisión	910236	1
18-3722	Tuerca apriete	121731	6
18-4248	Arandela	311598	2
18-7101	Aro tórico	305739	1
18-7102	Aro tórico	307450	1
18-7120	Aro tórico	307853, 322598	1
18-7130	Aro tórico	314728	1
18-7142	Aro tórico	322119	1
18-7178	Aro tórico	320140	1
18-7403	Aro tórico	909316	2
18-7404	Aro tórico	909747	1
18-7475	Aro Quad	332583	4
18-7168	Aro tórico	202893	1
18-7479	Aro tórico	—	1
18-3153	Tornillo	908158	2



18-2666
KIT RETENES ALOJAMIENTO ENGRANAJE SUP
 Reemplaza: 981799
 100-245 Stringer Unit (1968-72)

— CONTIENE —

Ref #	Desc.	O.E. #	Cant.
18-0939	Junta engranaje sup	315189	1
18-2073	Retén aceite	981268	4
18-3111	Retén goma	907774	1
18-4248	Arandela	311598	2
18-7103	Aro tórico	308624	4
18-7107	Aro tórico	313175	1
18-7121	Aro tórico	308621	1
18-7134	Aro tórico	303059	1
18-7146	Aro tórico	554545	1
18-7173	Aro tórico	910582	1
18-7198	Aro tórico	308626	2
18-7158	Aro tórico	310585, 310967	1
18-7172	Aro tórico	553126	1

— CONTIENE —

Ref #	Desc.	O.E. #	Cant.
18-0939	Junta engranaje superior	315189	1
18-2072	Retén aceite	0765461	2
18-2073	Retén aceite	981268	2
18-3111	Retén goma	907774	1
18-3725	tuerca apriete	908064	1
18-4248	Arandela	311598	2
18-4251	Tapón	908062	1
18-7107	Aro tórico	313175	1
18-7114	Aro tórico	302540	1
18-7121	Aro tórico	308621	1
18-7129	Aro tórico	314491	1
18-7477	Aro quad	909048	1
18-7168	Aro tórico	202893	1
18-7172	Aro tórico	553126	1
18-7173	Aro tórico	910582, 310327	1

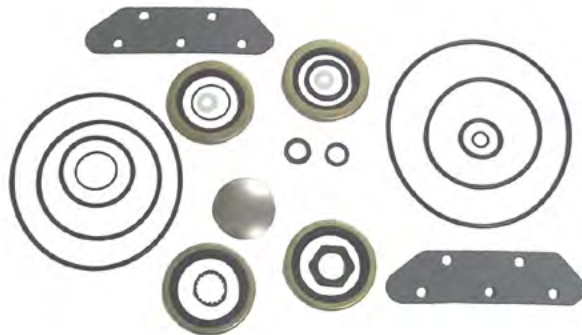

18-2667
KIT RETÉN UNIDAD SUPERIOR
 Reemplaza: 982949
 Todas Stringer Unit (1973-86)

— CONTIENE —

Ref #	Desc.	O.E. #	Cant.
18-0917	Junta motor tilt	311508	1
18-0923	Junta retén	313244	2
18-0939	Junta caja engranajes superior	315189	1
18-0949	Junta tapa	316499	2
18-2004	Retén aceite	—	1
18-2016	Retén aceite	0764337	2
18-2066	Retén aceite	911019	1
18-2071	Retén aceite	981195	2
18-3725	Tuerca apriete	908064	1
18-4248	Arandela	311598	1
18-4251	Conector	908062	1
18-7114	Aro tórico	302540	1
18-7162	Aro tórico	302337	1
18-7400	Aro tórico	908194	1
18-7401	Aro tórico	908383	1
18-7198	Aro tórico	308626	2
18-2863	Junta tapa tilt	308799	1

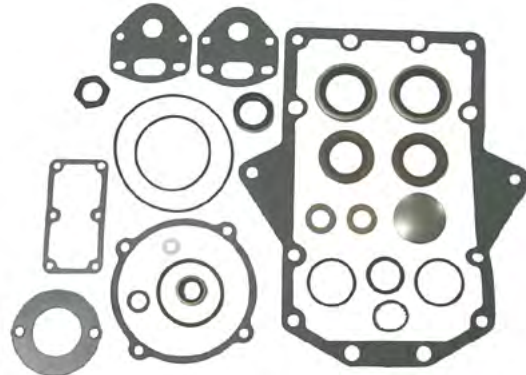

18-2669
KIT RETENES ALOJAMIENTO INTERMEDIO
 Reemplaza: 981801
 100-245 Stringer Unit (1973-77)

— CONTIENE —

Ref #	Desc.	O.E. #	Cant.
18-2004	Retén aceite	—	1
18-2016	Retén aceite	0764337	2
18-2060	Retén aceite	321467	2
18-2071	Retén aceite	981195	2
18-2863	Junta tapa tilt	308799	1
18-3725	Tuerca apriete	908064	1
18-4248	Arandela	311598	3
18-4251	Tapón	908062	1
18-7114	Aro tórico	302540	1
18-7162	Aro tórico	302337	1
18-7400	Aro tórico	908194	1
18-7401	Aro tórico	908383	1
18-7168	Aro tórico	202893	3
18-7198	Aro tórico	308626	2
18-0917	Junta motor Tilt	311508	1
18-0923	Retén	313244	2
18-0939	Junta superior engranajes	315189	1
18-0947	Junta tapa pivote	909529	2
18-0913	Junta motor tilt	909902	1

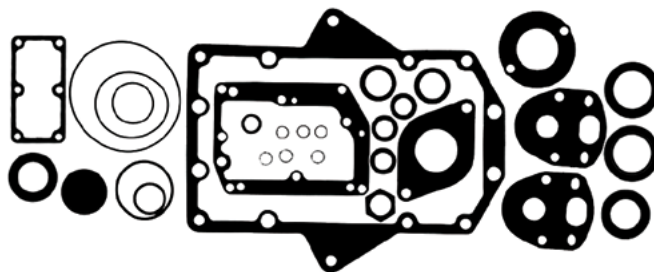

18-2670
KIT RETENES ALOJAMIENTO INTERMEDIO
 Reemplaza: 982948
 Todos Stringer Unit (1978-86)

— CONTIENE —

Ref #	Desc.	O.E. #	Cant.
18-0880	Junta tapa	911878	1
18-0166	Casquillo	911705	2
18-0190	Retén	912157	1
18-4248	Arandela	311598	2
18-7127	Aro tórico	313446	1
18-7130	Aro tórico	314728	1
18-7137	Aro tórico	318372	1
18-7138	Aro tórico	318717	3
18-7145	Aro tórico	333572	2
18-7475	Aro Quad	332584	5
18-2001	Retén aceite	330137	2

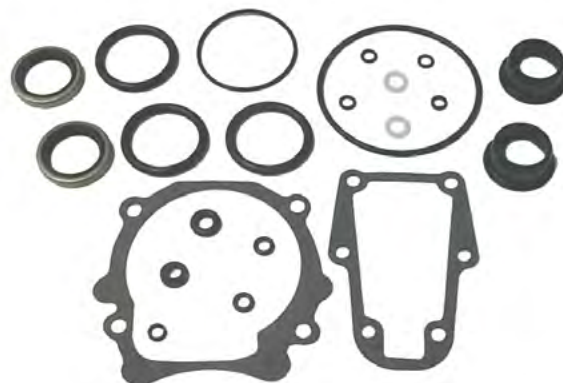

18-2671
KIT RETENES UNIDADES INFERIORES
 Reemplaza: 985612
 Todos 4 cil. Cobra (1986-89)



18-2672
KIT RETEN UNIDADES INFERIOR
 Reemplaza: 984458, 985613, 439967
 Todas V6/V8 Cobra (1986-1991)

— CONTIENE —

Ref #	Desc.	O.E. #	Cant.
18-0880	Junta tapa	911878	1
18-0166	Casquillo	911705	2
18-0190	Retén	912157	1
18-2002	Retén aceite	320862	2
18-4248	Arandela	311598	2
18-7130	Aro tórico	314728	1
18-7137	Aro tórico	318372	1
18-7138	Aro tórico	318717	3
18-7142	Aro tórico	322119	1
18-7145	Aro tórico	333572	2
18-7475	Aro Quad	332584	5
18-0440	Junta paso agua	915719	1



18-2673
KIT RETENES UNIDADES SUPERIOR
 Reemplaza: 984459, 986364, 987603
 Todos Cobra (1986-89)

— CONTIENE —

Ref #	Desc.	O.E. #	Cant.
18-0911	Junta base bomba agua	911698	1
18-0884	Junta tapa	911733	1
18-0166	Casquillo	911705	2
18-2067	Retén aceite	911685	1
18-2068	Retén aceite	3853655	1
18-2541	Retén goma	911704	1
18-2916	Junta alojamiento bomba agua	911702	1
18-2918	Transom	915840	1
18-2996	Retén	911823	1
18-7107	Aro tórico	313175	1
18-7116	Aro tórico	303067	1
18-7138	Aro tórico	318717	2
18-7153	Aro tórico	—	2
18-7169	Aro tórico	911686	1
18-7403	Aro tórico	909316	1
18-7407	Aro tórico	911700	1



18-2674
KIT RETENES ALOJAMIENTO TRANSOM
 Reemplaza: 985518, 986423
 Todos Cobra (1986-89)

— CONTIENE —

Ref #	Desc.	O.E. #	Cant.
18-2070	Retén aceite	911795	1
18-2138	Cojinete	911787	3
18-2139	Cojinete	911794	1
18-2533	Retén espuma	911797	1
18-2918	Transom	915840, 911836	1
18-2996	Retén	911823	1
18-4250	Arandela	911820	2
18-7141	Aro tórico	321117	12
18-7143	Aro tórico	322501	1
18-7162	Aro tórico	302337	1
18-7165	Aro tórico	304174	1
18-7406	Aro tórico	911311	3
18-7408	Aro tórico	911718	2
18-7409	Aro tórico	911871	1
18-7168	Aro tórico	202893	1
18-8349	Retén	3852548	1



18-2783
KIT RETÉN UNIDAD INFERIOR
 Reemplaza: 986629
 King Cobra unidad inferior - 1990



18-2791
KIT RETENES COLA
 Reemplaza: 987251, 3850597
 Para: 3.0L, 4.3L, 5.0L (1994), 3.2L (1992-93),
 5.7L (1992-94), 7.4L (1992-95), 8.2L (1992-93)

APLICACIÓN KIT RETENES

Modelo	Año	Kit engranaje inferior	Kit engranaje superior	Kit alojamiento intermedio	Kit Montaje transom	Modelo	Año	Kit engranaje inferior	Kit engranaje superior	Kit alojamiento intermedio	Kit Montaje transom
2.3	1987-90	18-2671	18-2673	N/D	18-2674	165	1972	18-2663	18-2666	18-2668	N/D
2.5 ①	1982-86	18-2664	18-2667	18-2670	N/D	165	1973-76	18-2663	18-2667	18-2669	N/D
2.5 ②	1986	18-2671	18-2673	N/D	18-2674	170	1974	18-2663	18-2667	18-2669	N/D
3 ①	1982-86	18-2664	18-2667	18-2670	N/D	175	1975-77	18-2663	18-2667	18-2669	N/D
3 ②	1986-91	18-2671	18-2667	18-2670	N/D	185	1968	18-2663	18-2666	18-2668	N/D
4.3 ①	1985-86	18-2665	18-2667	18-2670	N/D	185	1978-80	18-2665	18-2667	18-2670	N/D
4.3 ②	1986-91	18-2672	18-2673	N/D	18-2674	190	1974-77	18-2663	18-2667	18-2669	N/D
3.8	1981-86	18-2665	18-2667	18-2670	N/D	200	1968	18-2663	18-2666	18-2668	N/D
5 ①	1982-86	18-2665	18-2667	18-2670	N/D	200	1979-81	18-2665	18-2667	18-2670	N/D
5 ②	1986-91	18-2672	18-2673	N/D	18-2674	210	1968-70	18-2663	18-2666	18-2668	N/D
5.7 ①	1982-86	18-2665	18-2667	18-2670	N/D	215	1971	18-2663	18-2666	18-2668	N/D
5.7 ②	1986-89	18-2672	18-2673	N/D	18-2674	225	1972	18-2663	18-2666	18-2668	N/D
5.7 ③	1990-91	18-2672	18-2673	N/D	18-2674	225	1973-76	18-2663	18-2667	18-2669	N/D
5.8	1989-90	18-2672	18-2673	N/D	18-2674	225	1978	18-2665	18-2667	18-2670	N/D
7.5	1987	—	18-2673	N/D	18-2674	230	1979-81	18-2665	18-2667	18-2670	N/D
80	1969	18-2663	18-2666	18-2668	N/D	235	1971	18-2663	18-2666	18-2668	N/D
90	1970	18-2663	18-2666	18-2668	N/D	235	1975-77	18-2663	18-2667	18-2669	N/D
100	1972	18-2663	18-2666	18-2668	N/D	240	1978	18-2665	18-2667	18-2670	N/D
100	1973	18-2663	18-2667	18-2669	N/D	245	1972	18-2663	18-2666	18-2668	N/D
120	1968-72	18-2663	18-2666	18-2668	N/D	245	1973-75	18-2663	18-2667	18-2669	N/D
120	1973-77	18-2663	18-2667	18-2669	N/D	250	1979	18-2665	18-2667	18-2670	N/D
120	1978-81	18-2664	18-2667	18-2670	N/D	260	1979-81	18-2665	18-2667	18-2670	N/D
140	1973-77	18-2663	18-2667	18-2669	N/D	262	1989	18-2672	18-2673	N/D	18-2674
140	1978-81	18-2664	18-2667	18-2670	N/D	350	1988-89	18-2672	18-2673	N/D	18-2674
155	1968-72	18-2663	18-2666	18-2668	N/D	460	1988-89	—	18-2673	N/D	18-2674

① Excepto Cobra ② Cobra ③ Excepto L.E. N/D No disponible

RETENES ACEITE



Ref #	O.E. #	Diámetro eje	Dimensiones (pulg)		Ref #	O.E. #	Diámetro eje	Dimensiones (pulg)	
			D.E.	ancho				D.E.	ancho
18-0542	321831, 315288	0.750	1.253	0.186	18-2061	329922	0.822	1.375	0.195
18-0543	321895, 313507	1.540	1.926	0.243	18-2062	329923	0.875	1.375	0.207
	18-2063				330327		0.625	1.124	0.188
18-0559	332585	0.285	0.357	0.940	18-2064	332205	0.730	1.130	0.194
18-2000	309989	1.375	2.000	0.313	18-2065	332261	0.625	1.375	0.195
18-2001	330137	1.125	1.624	0.250	18-2066	911019	1.000	1.375	0.435
18-2002	320862	1.188	1.692	0.250	18-2067	911685	2.000	2.509	0.315
18-2005	313284	0.625	1.128	0.250	18-2068	3853655	0.500	0.905	0.250
18-2012	310599	1.000	1.499	0.250	18-2068	915702	0.500	0.905	0.250
18-2016	0764337	1.187	1.875	0.250	18-2068	916058	0.500	0.905	0.250
18-2018	0767970	1.000	1.375	0.250	18-2068	3853655	0.500	0.905	0.200
18-2020	310649	2.500	3.000	0.250	18-2071	981195	1.500	2.125	0.250
18-2022	303345	0.554	1.000	0.375	18-2072	0765461	1.750	2.502	0.250
18-2023	313282	0.554	1.062	0.312	18-2073	981268	1.625	2.502	0.250
18-2024	314167	0.425	0.937	0.312	18-8349	3852548	1.375	2.186	0.500
18-2025	318972	0.500	0.875	0.250					
18-2027	321459	0.625	1.125	0.250					
18-2030	321786	0.625	1.125	0.188					
18-2031	321787	0.625	1.125	0.312					
18-2033	321928	0.625	1.375	0.250					
18-2034	324639	0.437	0.937	0.188					
18-2058	313353	1.938	2.438	0.250					
18-2059	321466	0.750	1.126	0.200					
18-2060	321467	1.000	1.375	0.250					



CARCASA SUPERIOR (Cobra)				
MOTOR	Año	RETÉN ACEITE	DESC.	CANT
262 - 460	1988-89	18-2067	BC	1
262 - 460	1988-90	18-2068	WPS	1
2.3 - 7.5	1986-90	18-2068	WPS	1
2.3 - 7.5 ①	1986-90	18-2067	BC	1

① 5.7 '90 574 AMPWS, ARPWS
BC Retén cojinete
WPS Retén bomba agua

CARCASA INFERIOR (Stringer)				
MOTOR	AÑO	RETÉN ACEITE	DESC.	CANT
80/90	1968-71	18-2066	BR,L	2
80/90	1968-71	18-2066	PS	2
88/90	1964-68	18-2012	BR	1
80 - 260	1968-81	18-2020	BR,U	1
80 - 260	1968-81	18-2058	BR,M	2
110 - 200 ①	1964-67	18-2012	BR	2
110 - 245 ①	1964-77	18-2012	PS	2
110/120 ②	1964-67	18-2012	BR	1
120 - 245	1968-77	18-2012	BR,L	2
120 - 260	1978-81	18-2060	BR,L	2
120/140	1978-81	18-2001	PS	2
155 ③	1967	18-2058	BR,M	2
155 ③	1967	18-2020	BR,U	1
185 - 260	1978-81	18-2002	PS	2
210 - 260 ④	1972-75	18-2066	IH	1
230/260 ④	1976	18-2060	IH	1
305/350/454 ④	1977-78	18-2060	IH	1
2.5/3.0	1982-86	18-2001	PS	2
2.5 - 5.7	1981-86	18-2020	BR,U	1
2.5 - 5.7	1981-86	18-2058	BR,M	2
2.5 - 5.7	1981-86	18-2060	BR,L	2
3.8 - 5.7	1981-86	18-2002	PS	2

① 110, 120 HP '64-67 Hvy. Duty Dr.
 ② Transmisión Standard
 ③ Modelos HU, HUE 16 C
 ④ Intraborda
BR Retén cojinete eje transmisión
BR,U Retén cojinete superior eje transmisión
BR,M Retén cojinete medio eje transmisión
BR,L Retén cojinete inferior eje transmisión
IH Retén alojamiento impulsor
PS Retén eje hélice

CARCASA SUPERIOR (Stringer)				
MOTOR	AÑO	RETÉN ACEITE	DESC.	CANT
80 - 245	1968-72	18-2073	BGS	1
80 - 260	1969-81	18-2073	IH	2
88 - 200	1964-66	18-2000	BGS	1
90 ③	1967	18-2000	BGS	1
90 ④	1967	18-2073	BGS	1
100 - 245	1972-73	18-2073	BGS	1
100 - 260	1973-81	18-2072	BGS	2
120 ①	1967	18-2073	BGS	1
120 ②	1967	18-2000	BGS	1
120 ①	1967	18-2073	IH	2
120 - 210	1968	18-2073	IH	2
155	1967	18-2073	IH	2
155 ⑤	1967	18-2000	BGS	1
155	1967	18-2073	BGS	1
185	1967	18-2000	BGS	1
200 ⑥	1967	18-2000	BGS	1
200 ⑦	1967	18-2073	IH	2
200 ⑦	1967	18-2073	BGS	1
2.5 - 5.7	1981-86	18-2072	BGS	2
2.5 - 5.7	1981-86	18-2073	IH	2

① Modelos CU, CUE 16C ⑥ Modelos TU, TUE 15S
 ② Modelos CU15S Models ⑦ Modelos TU, TUE 16C
 ③ Modelos DU, DUE 14D **BGS** Retén eje
 ④ Modelos DU, DUE 15S **IH** Retén alojamiento impulsor
 ⑤ Modelos HU, HUE 15S

CARCASA INFERIOR (Cobra)				
MOTORES	AÑO	RETÉN ACEITE	DESC.	CANT
262 - 460	1988-89	18-2002	PS	2
2.3	1990	18-2001	PS	2
2.3 - 3.0	1986-89	18-2001	PS	2
3	1990	18-2002	PS	2
4.3 - 7.5	1986-90	18-2002	PS	2

PS Retén eje hélice

ALOJAMIENTO INTERMEDIO (Stringer)				
MOTOR	AÑO	RETÉN ACEITE	DESC.	CANT
80 - 235	1964-71	18-2000	BG,O	1
80 - 245	1964-72	18-2001	BG,I	1
80 - 260 ②	1964-80	18-2066	CL	1
100 - 245	1972	18-2000	BG,O	2
100 - 260	1973-79	18-2016	BG,I	1
100 - 260	1973-81	18-2071	BG,O	2
120 - 260	1980-81	18-2016	BG,I	2
120 - 260 ①	1980-81	18-2060	CL	2
2.5 - 5.7	1981-86	18-2060	CL	2
2.5 - 5.7	1981-86	18-2016	BG,I	2
2.5 - 5.7	1981-86	18-2071	BG,O	2

CL Embrague
 ① 120, 140 '80C Modelos/185-260 '80 K&U Modelos
 ② C Modelos en '80
BG,I Retén inferior eje transmisión
BG,O Retén exterior eje transmisión



AROS TÓRICOS

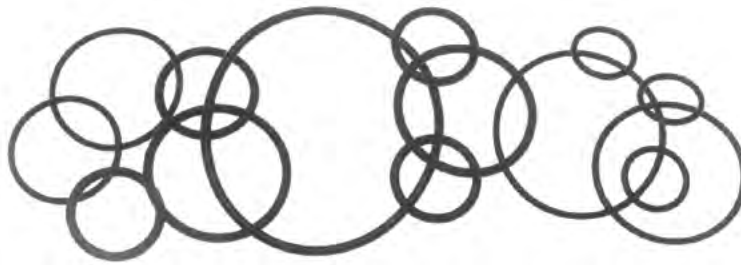

Ref #	O.E. #	Dimensiones (pulg.)		Ref #	O.E. #	Dimensiones (pulg.)	
		D.I.	Ancho			D.I.	Ancho
18-7100	② ⑤ 301877	.245	.155	18-7150	③ ⑤ 331380	.225	.115
18-7101	② ⑤ 305739	.250	.065	18-7150	③ ⑤ 334913	.225	.115
18-7102	② ⑤ 307450	.430	.065	18-7152	② ⑤ 307082	2.625	.135
18-7103	② ⑤ 308624	.920	.100	18-7153	① 3852565,		
18-7104	② ⑤ 308627	2.210	.135		911851	.0860	.100
18-7105	② ⑤ 311338	.750	.065	18-7155	② ⑤ 305270	1.620	.135
18-7107	② ⑤ 313175	4.750	.135	18-7156	② ⑤ 309731	1.185	.100
18-7108	② ⑤ 313893	2.550	.100	18-7158	② ⑤ 310585	.740	.100
18-7108	② ⑤ 338518	2.550	.100	18-7162	② ⑤ 302337	2.025	.135
18-7109	② ⑤ 317178	.214	.048	18-7164	② ⑤ 302537	1.375	.100
18-7111	① 301824	.197	.113	18-7165	② ⑤ 304174	.500	.065
18-7112	① 302493	1.170	.135	18-7167	② ⑤ 310414	3.625	.135
18-7114	② ⑤ 302540	1.000	.135	18-7168	② ⑤ 202893	.370	.065
18-7115	① 302588	1.735	.135	18-7169	② ⑤ 911686	3.500	.135
18-7116	① 303067	.360	.100	18-7170	① 307239	1.365	.135
18-7117	① 303360	1.060	.135	18-7172	② ⑤ 553126	3.250	.135
18-7118	② ⑤ 305242	.300	.135	18-7173	② ⑤ 310327	1.875	.135
18-7120	① 307853	.215	.065	18-7174	② ⑤ 326649	.620	.100
18-7120	① 332598	.215	.065	18-7178	② ⑤ 320140	.920	.135
18-7121	① 308621	3.100	.135	18-7180	② ⑤ 303347	.445	.090
18-7123	① 308876	2.235	.100	18-7198	② ⑤ 308626	1.430	.100
18-7126	① 313340	1.690	.100	18-7400	② ⑤ 908194	4.000	.100
18-7127	① 313446	3.315	.135	18-7401	② ⑤ 908383	2.485	.100
18-7128	① 313754	1.835	.100	18-7403	② ⑤ 909316	1.500	.100
18-7129	② ⑤ 314491	.970	.065	18-7404	② ⑤ 909747	.300	.100
18-7130	① 314728	2.125	.100	18-7406	② ⑤ 911311	0.250	.065
18-7133	② ⑤ 305123	3.780	.135	18-7407	② ⑤ 911700	4.125	.135
18-7134	② ⑤ 303059	.500	.100	18-7407	② ⑤ 3852531	4.125	.135
18-7135	① 310584	.750	.135	18-7408	② ⑤ 911718	1.060	.100
18-7137	② ⑤ 318372	0.320	.155	18-7409	② ⑤ 911871	1.175	.100
18-7138	② ⑤ 318717	1.500	.210	18-7413	② ⑤ 303191	.301	.070
18-7139	② ⑤ 319085	1.080	.210	18-7416	② ⑤ 329380	.612	.103
18-7140	② ⑤ 320303	2.750	.135	18-7417	② ⑤ 329381	.362	.103
18-7141	② ⑤ 321117	.180	.065	18-7418	② ⑤ 326741	4.484	.139
18-7142	② ⑤ 322119	3.940	.135	18-7440-1	④ 301967	.799	.103
18-7143	② ⑤ 322501, 331188	1.310	.100	18-7457	① 319662	1.799	.103
18-7144	② ⑤ 326849	4.250	.135	18-7461	① 308458	1.612	.103
18-7145	② ⑤ 333572	.250	.100	18-7475	② ⑤ 332584	.250	.065
18-7146	② ⑤ 554545	1.120	.100	18-7477	② ⑤ 909048	.480	.100
18-7150	③ ⑤ 303598	.225	.115	18-7510	① 321163	2.750	.070

① Pack. de 1 ② Pack. de 5 ③ Pack. de 10 ④ Indica Aros Quad en lugar de Aros tóricos

MONTAJE TRANSOM (Cobra)

MONTAJE TRANSOM (Cobra) (Cont.)

MOTOR	AÑO	ARO TÓRICO	DESC.	CANT.	MOTOR	AÑO	ARO TÓRICO	DESC.	CANT.
262 - 460	1988-89	18-7165	SCS	1	2.3 - 7.5 ①	1986-90	18-7165	SCS	1
262 - 460	1988-89	18-7408	NP	2	2.3 - 7.5 ①	1986-90	18-7409	SC	1
262 - 460	1988-89	18-7409	SC	1	2.3 - 7.5	1986-90	18-7143	MB	1
262 - 460	1988-89	18-7406	PL	1					
262 - 460	1988-89	18-7168	BC	1					
262 - 460	1988-90	18-7162	UG	1					
262 - 460	1988-90	18-7143	MB	1					
2.3 - 7.5 ①	1986-90	18-7168	BC	1					
2.3 - 7.5	1986-90	18-7162	UG	1					
2.3 - 7.5 ①	1986-90	18-7406	PL	1					
2.3 - 7.5 ①	1986-90	18-7408	NP	2					

① 5.7 '90 574 AMPWS, ARPWS
BC Retén campana
MB Retén colector
UG Retén superior
SCS Retén cable cambio
PL Retén tapón
NP Retén
SC Retén conector

⑤ Este precio de este producto es por pieza. Para pedir precio en envase por favor añadir -9 a la referencia.

STERNDRIIVE/COBRA - Aros tóricos
OMC

CARCASA SUPERIOR (Cobra)				
MOTOR	AÑO	ARO TÓRICO	DESC.	CANT
262 - 460	1988-89	18-7403	A,S	1
262 - 460	1988-89	18-7107	GHC	1
262 - 460	1988-89	18-7407	A,L	1
262 - 460	1988-90	18-7169	BC	1
350 - 460	1990	18-7116	OFF	1
350 - 460	1990	18-7407	BC	1
350 - 460	1990	18-7406	WDP	1
370	1988	18-7407	AB	1
460	1990	18-7407	BC	1
2.3 - 5.8	1990	18-7116	OFF	1
2.3 - 7.5	① 1986-90	18-7107	GHC	1
2.3 - 7.5	① 1986-90	18-7407	A,L	1
2.3 - 7.5	1986-90	18-7169	BC	1
2.3 - 7.5	① 1986-90	18-7403	A,S	1
5.7	② 1990	18-7406	WDP	1
5.7	② 1990	18-7407	BC	1

- ① 5.7 '90 574 AMPWS, ARPWS
- ② 574 PEPWS
- GHC** Retén tapón aloj. engr
- OFF** Retén tapón aceite
- BC** Retén cojinete
- A,S** Retén pequeño adaptador
- A,L** Retén grande adaptador
- WDP** Retén tapón drenaje igual
- AB** Retén bloqueo

CARCASA INFERIOR (Cobra)				
MOTOR	AÑO	ARO TÓRICO	DESC.	CANT
262/350	1988-89	18-7475	PBHS	4
262/350	1988-89	18-7142	PBH	1
262 - 460	1988-89	18-7130	DS B	1
262 - 460	1988-89	18-7475	BSS	1
262 - 460	1988-89	18-7138	DS BH	3
262 - 460	1988-89	18-7137	SR	1
350 - 460	1990	18-7145	PL	1
370	1988	18-7130	SL	2
370/460	1988-89	18-7145	D&F S	2
2.3	1987	18-7145	D&F S	2
2.3	1990	18-7127	PBH	1
2.3 - 3.0	1986-89	18-7127	PBH	1
2.3/3.0	1988-90	18-7145	D&F S	2
2.5 - 5.7	1986	18-7145	D&F S	2
2.3 - 5.8	① 1986-90	18-7475	PBHS	4
2.3 - 7.5	① 1986-90	18-7475	BSS	1
2.3 - 7.5	① 1986-90	18-7138	DS BH	3
2.3 - 7.5	① 1986-90	18-7137	SR	1
2.3 - 7.5	① 1986-90	18-7130	DS B	1
3.0 - 5.8	① 1990	18-7142	PBH	1
4.3 - 5.8	1989-89	18-7142	PBH	1
5.7	② 1990	18-7145	PLUG	1

- ① 5.7 '90 574 AMPWS, ARPWS
- ② 574 PEPWS
- BSS** Retén cojinete
- DS BH** Retén cojinete aloj. eje transmisión
- DS B** Retén cojinete eje transmisión
- D&F S** Retén tornillo drenaje y llenado
- PBH** Retén cojinete hélice
- PBHS** Retén cojinete tornillo hélice
- PL** Retén tapón
- SR** Retén cambio
- SL** Retén sleeve

POWER TILT Y TRIM (Cobra)				
MOTOR	AÑO	ARO TÓRICO	DESC.	CANT
262 - 460	1988-90	18-7141	OL	12
262 - 460	1988-90	18-7102	PL	1
350 - 460	1988	18-7174	VSH	1
350 - 460	1988	18-7168	VS	4
350 - 460	1988	18-7174	VA,L	2
350 - 460	1988	18-7165	VA,S	2
2.3 - 7.5	1986-88	18-7174	VSH	1
2.3 - 7.5	1986-88	18-7168	VS	4
2.3 - 7.5	1986-88	18-7174	VA,L	2
2.3 - 7.5	1986-88	18-7165	VA,S	2
2.3-7.5	1986-90	18-7102	PL	1
2.3-7.5	1986-90	18-7141	OL	12

- PL** Retén tapón
- VS** Retén asiento válvula
- VA,L** Retén grande asiento válvula
- VA,S** Retén pequeño asiento válvula
- VSH** Retén alojamiento asiento válvula
- OL** Retén línea aceite

SISTEMA REFRIGERACIÓN Y ACEITE (Cobra)				
MOTOR	AÑO	ARO TÓRICO	DESC.	CANT
262/454	1989-90	18-7135	AR	1
262 - 460	1988-90	18-7116	ODF	1
350/460	1988-90	18-7135	AR	1
370	1988	18-7162	THERM	1
2.3 - 5.8	1988-90	18-7116	ODF	1
4.3	① 1990	18-7135	AR	1
7.5	1987	18-7135	AR	1

- ① V-4 Sólo
- ODF** Retén drenaje aceite
- AR** Retén adaptador
- THERM** Retén termostato

CULATA (Stringer)				
MOTOR	AÑO	ARO TÓRICO	DESC.	CANT
80/90	1969-71	18-7108	WP	1
88	1964	18-7133	CCH	3
88/90	1964-68	18-7120	CCHS	4
90	1965-68	18-7133	CCH	4
120/140	1977-80	18-7114	CP	1
120 - 235	1976	18-7114	CP	1

- WP** Retén bomba agua
- CCH** Retén culata
- CCHS** Retén tornillo culata
- CP** Retén acoplado

ALOJAMIENTO INTERMEDIO (Stringer)				
MOTOR	AÑO	ARO TÓRICO	DESC.	CANT
80	1968	18-7162	SL	1
80 - 90	1964-68	18-7174	WT	1
80 - 210	1964-70	18-7123	BGR	1
80 - 245	① 1964-72	18-7174	PS	1
80 - 260	1964-81	18-7198	COV	2
80 - 260	1964-81	18-7114	WR	1
80 - 260	1969-81	18-7162	SL	1
88	1964	18-7104	TH	1
88	1964	18-7174	TC	1

ALOJAMIENTO INTERMEDIO (Stringer) (Cont.)				
MOTOR	AÑO	ARO TÓRICO	DESC.	CANT
90 - 235	1970-71	18-7158	DS	1
90 - 235	② 1971	18-7123	BGR	1
100 - 260	1973-81	18-7401	BGR	1
100 - 260	1973-81	18-7400	TUC	1
120	③ 1967	18-7162	SL	1
120 - 210	1968	18-7162	SL	1
120/140	1981	18-7168	FS	3
155	④ 1967	18-7162	SL	1
2.5 - 5.7	1981-86	18-7400	TUC	1
2.5 - 5.7	1981-86	18-7198	COV	2
2.5 - 5.7	1981-86	18-7114	WR	1
2.5 - 5.7	1981-86	18-7401	BGR	1
2.5 - 5.7	1981-86	18-7162	SL	1
2.5 - 5.7	1982	18-7168	FS	3

- ① Modelos dirección de tiro
 ② Todos 90/120, 155, 210 EX Modelos/235 XUFM20S ant a S/N 202880 y 235 XUFM20S ant a S/N 204600
 ③ CU, CUE 16C
 ④ 120, 155, 215, 20D Modelos/235 XUFR20S S/N 202880 & sup y 235 XUFM20S S/N 204600 & sup 235 20D todos Modelos

COV Retén tapa pivote
 BGR Retén engranaje bolas
 DS Retén eje dirección
 TC Retén eje tubo dirección
 TH Tubo eje dirección a alojamiento
 FS Retén tornillo llenado
 PS Eje polea
 SL Retén alojamiento a sleeve
 TUC Retén tapa tilt
 WT Retén tubo agua
 WR Retén engranaje arrastre

CARCASA SUPERIOR (Stringer)

MOTOR	AÑO	ARO TÓRICO	DESC.	CANT
80 - 90	1968-71	18-7158	BG	1
80 - 90	1964-68	18-7174	IH	1
80 - 245	① 1964-72	18-7103	WG	1
80 - 245	① 1964-74	18-7134	G	1
80 - 260	1964-81	18-7172	IH	1
80 - 260	1964-81	18-7121	BGR	1
80 - 260	1968-80	18-7173	WW	1
80 - 260	② 1968-81	18-7107	WW	1
90	③ 1967	18-7107	WW	1
90 - 200	1964-67	18-7128	CAP	1
90 - 200	1965-67	18-7173	WW	2
90 - 245	④ 1967-72	18-7146	BG	1
100 - 245	1973-75	18-7114	WS	1
100 - 260	1973-81	18-7129	DS IH	1
110 - 120	⑤ 1964-67	18-7158	IH	1
110 - 120	⑥ 1964-67	18-7174	IH	1
120 - 200	⑦ 1967	18-7107	WW	1
120 - 235	1968-71	18-7158	IH	1
120 - 260	1975-81	18-7477	G	1
150 - 210	1964-67	18-7158	IH	1
2.5/3.0	1982	18-7168	OP	1
2.5 - 5.7	1981-86	18-7477	G	1
2.5 - 5.7	1981-86	18-7172	IH	1
2.5 - 5.7	1981-86	18-7107	WW	1
2.5 - 5.7	1981-86	18-7121	BGR	1
2.5 - 5.7	1981-86	18-7129	DS IH	1

CARCASA SUPERIOR (Stringer) (Cont.)

- ① Modelos dirección tiro
 ② 155 HP 1968 HU, HUE 16C
 ③ DU, DUE 15S
 ④ 90 HP '67 DU, DUE 15S/120 and 200 '67 16C Modelos
 ⑤ Heavy Duty transmisión
 ⑥ Caja engranajes standard
 ⑦ 16C Modelos
 BG Retén engranajes
 BGR Retén engranaje bolas
 DS IH Retén impulsor eje transmisión
 IH Retén alojamiento impulsor
 CAP Retén tapa aloj. engranaje
 OP Retén tapón aceite
 WR Retén retenedor dirección
 WS Retén espaciador dirección
 WG Retén engranaje dirección
 WW Retén dirección
 G Retén engranaje

CARCASA INFERIOR (Stringer)

MOTOR	AÑO	ARO TÓRICO	DESC.	CANT
80 - 90	1964-69	18-7120	PBH S	4
80 - 90	1964-71	18-7152	PBH	1
80 - 90	1964-71	18-7115	BR	1
80 - 90	1964-71	18-7174	DS	1
88/90	1964-68	18-7173	DSB	2
90 - 245	1970-77	18-7120	PBH S	4
100 - 245	1968-72	18-7135	BR	1
100 - 245	1969-77	18-7167	PBH	1
110/120	② 1964-67	18-7167	PBH	1
110/120	① 1964-67	18-7174	DS	1
110/120	② 1964-67	18-7135	BR	1
110/120	① 1964-67	18-7152	PBH	1
110/120	① 1964-67	18-7173	DSB	2
110/120	① 1964-67	18-7115	BR	1
120	① 1964-67	18-7120	PBH S	4
120/140	1978-81	18-7127	PBH	1
120/140	1978	18-7156	SA,L	2
120 - 235	1977	18-7129	DS	1
120 - 240	1978	18-7178	SA,S	1
120 - 260	1978-81	18-7130	BR	1
120 - 260	1978-81	18-7102	PIN	1
120 - 260	1978-81	18-7109	PBH S	4
120 - 260	1978-81	18-7404	PIN	1
120 - 260	1979-81	18-7120	BSS	1
120 - 260	1981	18-7168	D&F S	1
150 - 200	1964-67	18-7135	BR	1
150 - 210	1964-68	18-7167	PBH	1
185 - 240	1978	18-7403	SA,L	2
185 - 260	1978-81	18-7142	PBH	1
2.5 - 5.7	1981-82	18-7168	D&F S	1
2.5 - 5.7	1981-83	18-7109	PBH S	4
2.5 - 5.7	1981-86	18-7130	BR	1
2.5 - 5.7	1981-86	18-7102	PIN	1
2.5 - 5.7	1981-86	18-7404	PIN	1
2.5 - 5.7	1981-86	18-7120	BSS	1
2.5 - 5.7	1981-86	18-7142	PBH	1
2.5/3.0	1982-86	18-7127	PBH	1
3.8	1981	18-7101	OSV	1

- ① Transmisión estándar
 ② Transmisión Heavy Duty
 OSV Retén válvula aceite
 PIN Retén eje piñon
 BR Retén cojinete eje transmisión
 DS Retén transmisión
 PBH Retén cojinete hélice
 DSB Retén eje transmisión
 PBH S Retén tornillo cojinete hélice
 D&F S Retén tornillo llenado y drenaje
 SA,L Retén grande cambio
 SA,S Retén pequeño
 BSS Kit cojinete retén tornillo



OMC



AÑO	MOTOR BUJÍA	MODELO	Ref. CHAMPION	AÑO	MOTOR BUJÍA	MODELO	Ref. NGK
1990-87	2.3L Cobra	RS12YC	050949	1990-87	2.3L Cobra	TR5	050708
1996	3.0L SXCobra	RS12YC	050949	1996	3.0L SX Cobra	TR5	050708
1995-90	3.0L Cobra HO	RS12YC	050949	1995-90	3.0L Cobra HO	TR5	050708
1994-93	3.0 Cobra	RS12YC	050949	1994-93	3.0L Cobra	TR5	050708
1992-87	3.0L Cobra	RV15YC4	050928	1992-87	3.0L Cobra	UR4	050878
1996 (.460)	4.3L SXCobra	RV15YC4	050928	1996 (.460)	4.3L SX Cobra	UR4	050878
1996 (.708)	4.3L SXCobra	RS12YC	050949	1996 (.708)	4.3L SX Cobra	TR5	050708
1995-86	4.3L Cobra	RV15YC4	050928	1995-86	4.3L Cobra	UR4	050878
1991-90	4.3L Cobra HO	RV15YC4	050928	1991-90	4.3L Cobra HO	UR4	050878
1994-93	4.3L Cobra HO	RV15YC4	050928	1994-93	4.3L Cobra HO	UR4	050878
1996 (Carb)	5.0 SX Cobra	RV15YC4	050928	1996 (Carb)	5.0L SX Cobra	UR4	050878
1996 (EFI)	5.0L SX Cobra	RS12YC	050949	1996 (EFI)	5.0L SX Cobra	TR5	050708
1995-96 (Carb)	5.0L Cobra	RV15YC4	050928	1995-96 (Carb)	5.0L Cobra	UR4	050878
1995-89 (Carb)	5.0L Cobra HO	RV15YC4	050928	1995-89 (Carb)	5.0L Cobra HO	UR4	050878
1995-94	5.0L Cobra EFI	RS12YC	050949	1995-94	5.0L Cobra EFI	TR5	050708
1993	5.0L Cobra EFI	RV15YC4	050928	1993	5.0L Cobra EFI	UR4	050878
1996	5.7L SX Cobra	RV15YC4	050928	1996	5.7L SX Cobra	UR4	050878
1992-86	5.7L King Cobra	RV15YC4	050928	1992-86	5.7L King Cobra	UR4	050878
1996(Carb)	5.8L SX Cobra	RV15YC4	050928	1996 (Carb)	5.8L SX Cobra	UR4	050878
1996 (EFI)	5.8L SX Cobra	RS9YC	050955	1996 (EFI)	5.8L SX Cobra	TR5	050708
1995-89 (Carb)	5.8L Cobra	RV15YC4	050928	1995-89 (Carb)	5.8L Cobra	UR4	050878
1995-92 (EFI)	5.8L Cobra	RS9YC	050955	1995-92 (EFI)	5.8L Cobra	TR5	050708
1995-93 (EFIHO)	5.8L King Cobra	RS9YC	050955	1995-93 (EFIHO)	5.8L King Cobra	TR5	050708
1996	7.4L SX Cobra	RV15YC4	050928	1996	7.4L SX Cobra	UR4	050878
1995-90 (Carb)	7.4L SX Cobra	RV15YC4	050928	1995-90 (Carb)	7.4L SX Cobra	UR4	050878
1995 (EFI)	7.4L King Cobra	RV15YC4	050928	1995 (EFI)	7.4L King Cobra	UR4	050878
1993-91 (Carb)	7.4L Cobra HO	RV15YC4	050928	1993-91 (Carb)	7.4L Cobra HO	UR4	050878
1990-86	7.5L Cobra	RV15YC4	050928	1990-86	7.5L Cobra	UR4	050878
1996	8.2L SX Cobra	RV15YC4	050928	1996	8.2L SXCobra	UR4	050878
1994-92	8.2L King Cobra	RV15YC4	050928	1994-92	8.2L King Cobra	UR4	050878



HÉLICES BAEKSAN



- Baeksan fabrica miles de hélices desde el año 1984. Nuestras helices de altas prestaciones fabricadas con los mejores materiales aseguran una larga vida y una navegación tranquila y sin sobresaltos.
- Sus palas compensadas ofrecen una reducción significativa de la vibraciones.
- Cojinete de goma insertado en el nucleo en versión fija o nucleo intercambiable.
- Mano de pintura de alto grosor para evitar la corrosión.

**En caso de no conocer la referencia original de la hélice a reemplazar siga los siguientes pasos:
Comprueba el rango de Revoluciones por minuto (RPM) del fabricante del motor en el manual.**

1. Comprueba las RPM maximas del motor leyendo el panel para determinar el paso y velocidad optimo.
2. Si las RPM maximas exceden el rango recomendado, disminuye las RPM utilizando un paso superior.
3. Si las RPM son mas bajas que el rango recomendado, aumenta las RPM utilizando un paso inferior.

Si no localiza la hélice que necesita contacte con nuestro departamento técnico.

O.M.C.

Tipo	Modelo intraborda	Referencia-Diam./Paso	Ref. Original	Pala	Núcleo
D	 <p>4-1/4" Caja de engranajes Modelo 400</p> <ul style="list-style-type: none"> • 2.3 L (120hp) hasta 1991 • 2.5 L (120hp) 1978-1984 • 3.0 L (140hp) hasta 1989 <p>Cobra</p> <ul style="list-style-type: none"> • 2.3 L (128hp) 1988-1991 • 2.5 L (120hp) 1985-1987 • 3.0 L (140hp) 1985-1987 <p>Sea Drive 1982 y posterior</p> <ul style="list-style-type: none"> • 1.6L V-4 1982 y posterior • 1.8L V-4 1987 y posterior <p>Escape a través del núcleo 13 estrias</p>	62J701413 14x13	391668	3	Fijo
		62J70133415 13 3/4x15	391198	3	
		62J70131417 13 1/4x17	763463	3	
		62J701417 14x17	176214	3	
		62J70131419 13 1/4x19	763464	3	
E	  <p>4-3/4" Caja de engranajes</p> <p>Modelo 800, Cobra, King Cobra</p> <ul style="list-style-type: none"> • 3.0L - 8.2L (no colas SX) 1990-1993 • Cobra 5.8 L 1990-1993 • Sea Drive 2.0 - 4.0 L todos años <p>Escape a través del núcleo 15 estrias</p> <p>** Para todos los modelos anteriores al 1990 se requiere arandela Mercruiser Alpha One</p>	62J150151213 15 1/2x13	763453	3	Fijo
		62J150151215 15 1/2x15	391535	3	
		62J1501517 15x17	391200	3	
		62U150151415 15 1/4x15	48-78116A45	3	Interc. 62BHJE
		62U1351517 15x17	48-832828A45	3	
		62U150141219 14 1/2x19	48-832830A45	3	
		62U150141421 14 1/4x21	48-832832A45	3	
		62U1501423 14x23	48-832834A45	3	
		624U1501516 15x16	48-834850A45	4	
		624U150141218 14 1/2x18	48-834852A45	4	
624U1501420 14x20	48-834854A45	4			

APLICACIONES MOTORES DE GASOLINA



Modelo aplic.	Filtro aceite	Filtro comb.	Impulsor	Correa
MB 10 A	18-7878-1	—	18-3080	—
BB 30	18-7878-1	—	18-3080	—
BB 100	18-7878-1	—	18-3080	—
MB 18	18-7878-1	—	18-3080	—
AQ 60 F	18-7878-1	—	18-3080	—
MB 18 F	18-7878-1	—	18-3080	—
AQ 90	18-7878-1	—	18-3080	—
AQ 95	18-7878-1	—	18-3080	—
AQ 100	18-7878-1	—	18-3080	—
AQ 95A	18-7878-1	—	18-3080	—
AQ 110	18-7878-1	—	18-3080	—
AQ 120	18-7878-1	—	18-3080	—
BB 115 A	18-7878-1	—	18-3080	—
BB 115 B	18-7878-1	—	18-3080	—
BB 115 C	18-7878-1	—	18-3080	—
MB 20 A	18-7878-1	—	18-3080	—
MB 20 B	18-7878-1	—	18-3080	—
MB 20 C	18-7878-1	—	18-3080	—
AQ 115 A	18-7878-1	—	18-3080	—
AQ 115 B	18-7878-1	—	18-3080	—
AQ 130 A	18-7878-1	—	18-3080	—
AQ 130 B	18-7878-1	—	18-3080	—
AQ 130 C	18-7878-1	—	18-3080	—
AQ 130 D	18-7878-1	—	18-3080	—
BB 165 A	18-7878-1	—	18-3075	18-4044
BB 170 A	18-7878-1	—	18-3075	18-4044
BB 170 B	18-7878-1	—	18-3075	18-4044
BB 170 C	18-7878-1	—	18-3075	18-4044
AQ 165 A	18-7878-1	—	18-3075	18-4044
AQ 170 A	18-7878-1	—	18-3075	18-4044
AQ 170 B	18-7878-1	—	18-3075	18-4044
AQ 170 C	18-7878-1	—	18-3075	18-4044
AQ 120 B	18-7878-1	18-7862 18-7858	18-3075	18-4044
AQ 125 A	18-7878-1	18-7862 18-7858	18-3075	18-4044
AQ 125 B	18-7878-1	18-7862 18-7858	18-3075	18-15435
AQ 131 A	18-7878-1	18-7862 18-7858	18-3075	18-15435
AQ 131 B	18-7878-1	18-7862 18-7858	18-3075	18-15435
AQ 131 C	18-7878-1	18-7862 18-7858	18-3075	18-15435
AQ 131 D	18-7878-1	18-7862 18-7858	18-3075	18-15435
230A	18-7878-1	18-7862 18-7858	18-3075	18-15435
230B	18-7878-1	18-7862 18-7858	18-3075	18-4044

Modelo aplic.	Filtro aceite	Filtro comb.	Impulsor	Correa
BB 140 A	18-7878-1	18-7862 18-7858	18-3075	18-4044
AQ 140 A	18-7878-1	18-7862 18-7858	18-3075	18-4044
BB 145 A	18-7878-1	18-7862 18-7858	18-3075	18-4044
AQ 145 A	18-7878-1	18-7862 18-7858	18-3075	18-4044
AQ 145 B	18-7878-1	18-7862 18-7858	18-3075	18-15435
AQ 151 A	18-7878-1	18-7862 18-7858	18-3075	18-15435
AQ 151 B	18-7878-1	18-7862 18-7858	18-3075	18-15435
AQ 151 C	18-7878-1	18-7862 18-7858	18-3075	18-15435
250 A	18-7878-1	18-7862 18-7858	18-3075	18-4044
250 B	18-7878-1	18-7862 18-7858	18-3075	18-4044
AQ 171 A	18-7878-1	18-7862 18-7858	18-3075	18-15435
AQ 171 C	18-7878-1	18-7862 18-7858	18-3075	18-15435
251 A	18-7878-1	18-7862 18-7858	18-3075	18-4044
3.0 GL	18-7824-1	—	18-3060	—
3.0 GS	18-7824-1	—	18-3060	—
AQ 175 A	18-7879-1	18-7862 18-7858	18-3081	18-4046
430 A	18-7879-1	18-7862 18-7858	18-3081	18-4046
430 B	18-7879-1	18-7862 18-7858	18-3081	18-4046
AQ 190A	18-7875	—	18-3061	—
AQ 200 B	18-7824-1	18-7862 18-7858	18-3060	18-4046 [Ⓢ]
AQ 200 C	18-7824-1	18-7862 18-7858	18-3060	18-4046 [Ⓢ]
AQ 200 D	18-7824-1	18-7862 18-7858	18-3081	18-4046
AQ 200 F	18-7824-1	18-7862 18-7858	18-3081	18-4046
AQ 205 A	18-7879-1	18-7845 18-7858 18-7845	—	18-4046
431 A	18-7879-1	18-7858	—	18-4046
431 B	18-7879-1	18-7845 18-7858	18-3081	18-4046
432 A	18-7879-1	18-7845 18-7858	18-3081	—
434 A	18-7879-1	18-7845 18-7858	18-3081	—
4.3 GL	18-7879-1	—	18-3060	—

[Ⓢ] Alternador

APLICACIONES MOTORES DE GASOLINA



Modelo aplic.	Filtro aceite	Filtro comb.	Impulsor	Correa
4.3 GS	18-7879-1	—	18-3060	—
4.3 GI	18-7879-1	—	18-3081	—
AQ 211 A	18-7824-1	18-7858	18-3081	18-4046
500 A	18-7824-1	18-7845 18-7858	18-3081	18-4046
500 B	18-7824-1	18-7845 18-7858	18-3081	18-4046
AQ 225 B	18-7824-1	18-7862	18-3060	18-4046 ②
AQ 225 C	18-7824-1	18-7862 18-7858	18-3060	18-4046 ②
AQ 225 D	18-7824-1	18-7862 18-7858	—	18-4046
AQ 225 E	18-7824-1	18-7862 18-7858	—	18-4046
AQ 225 F	18-7824-1	18-7862 18-7858	—	18-4046
BB 225 A	18-7824-1	18-7862 18-7858	18-3081	—
BB 225 B	18-7824-1	18-7862 18-7858	18-3081	18-4046
BB 225 C	18-7824-1	18-7845 18-7858	18-3081	18-4046
AQ 231 A	18-7824-1	18-7845 18-7858	18-3081	18-4046
AQ 231 B	18-7824-1	18-7845 18-7858	18-3081	18-4046
BB 231 A	18-7824-1	18-7845 18-7858	—	18-4046
501 A	18-7824-1	18-7845 18-7858	18-3081	18-4046
501 B	18-7824-1	18-7845 18-7858	18-3081	18-4046
5.0 FL	18-7875	—	18-3060	18-3081
5.0 FI	18-7875	—	18-3060	18-3081
5.7 GL	18-7824-1	—	18-3060	—
5.7 GI	18-7824-1	—	18-3060	—
5.8 FL	18-7875	—	18-3060	18-3081
5.8 FI	18-7875	—	18-3060	18-3081
5.8 FSI	18-7875	—	18-3060	18-3081
AQ 240 A	18-7875	—	18-3061	—
AQ 255 A	18-7824-1	18-7862 18-7858	—	18-4046
AQ 255 B	18-7824-1	18-7862 18-7858	18-3081	18-4046

Modelo aplic.	Filtro aceite	Filtro comb.	Impulsor	Correa
AQ 260 A	18-7824-1	18-7862 18-7858	18-3081	18-4046
AQ 260 B	18-7824-1	18-7862 18-7858	—	18-4046
BB 260 A	18-7824-1	18-7862 18-7858	18-3081	18-4046
BB 260 B	18-7824-1	18-7862 18-7858	18-3081	18-4046
BB 260 C	18-7824-1	18-7862 18-7858	18-3081	18-4046
BB 261 A	18-7824-1	18-7845 18-7858	18-3081	18-4046
AQ 271 A	18-7824-1	18-7845 18-7858	18-3081	18-4046
AQ 271 B	18-7824-1	18-7845 18-7858	18-3081	18-4046
AQ 271 C	18-7824-1	18-7845 18-7858	18-3081	18-4046
AQ 271 D	18-7824-1	18-7845 18-7858	18-3081	18-4046
570 A	18-7824-1	18-7845 18-7858	18-3081	18-4046
572 A	18-7824-1	18-7845 18-7858	18-3081	18-4046
570 A/MS 4A	18-7824-1	18-7845 18-7858	18-3081	18-4046
AQ 280 A	18-7824-1	18-7862 18-7858	18-3081	18-4046
AQ 290 A	18-7824-1	18-7862 18-7858	18-3081	18-4046
AQ 311 A	18-7824-1	18-7845 18-7858	18-3081	18-4046
AQ 311 B	18-7824-1	18-7845 18-7858	18-3081	—
571 A	18-7824-1	18-7858	18-3081	18-4046
740 A	—	18-7845	—	—
740 B	18-7824-1	18-7845	—	—
7.4 GL	18-7824-1	—	18-3081 18-3060	—
7.4 GI	18-7824-1	—	18-3081	—
7.4 GSI	18-7824-1	—	18-3081	—
8.2 GL	18-7824-1	—	18-3081 18-3060	—

② Alternador





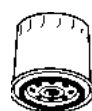
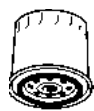







APLICACIONES MOTORES DE GASOLINA



Modelo aplic.	Filtro aceite	Filtro comb.	Impulsor	Correa
2001, B	18-7884	18-7858	18-3076	—
2002, B	18-7884	18-7858	18-3076	—
2003, B	18-7884	18-7858	18-3076	—
2003 T,TB	18-7884	18-7858	18-3081	—
MD 2010 A,B	—	18-7858	18-3079	—
MD 2020 A,B	—	18-7858	18-3079	—
MD 2030 A,B	—	18-7858	18-3080	—
MD 2040 A,B	—	18-7858	18-3080	—
MD 1	—	—	18-3079 ②	—
MD 1 B	18-7884	—	18-3079	—
MD 2	18-7884	—	18-3079 ③	—
MD 2 B	18-7884	—	18-3079	—
AQD 2 B	18-7884	—	18-3079	—
MD 3 B	18-7884	—	18-3080	—
MD 5 A	18-7884	—	18-3076	—
MD 5 B	18-7884	—	18-3076	—
MD 5 C	18-7884	—	18-3076	—
MD 6 A	18-7884	—	18-3079	—
MD 6 B	18-7884	—	18-3076	—
MD 7 A	18-7884	—	18-3076	—
MD 7 B	18-7884	—	18-3076	—
MD 11 C	18-7884	—	18-3076	—
MD 11 D	18-7884	—	18-3076	—
MD 17 C	18-7884	—	18-3080	—
MD 17 D	18-7884	—	18-3080	—
MD 22 A	—	—	18-3081	—
MD 22 L-A	—	—	18-3081	—
TMD 22 A	—	—	18-3081	—
AQD 21 A	—	18-7858	18-3081 ④ 18-3075 ⑤	18-15460
MD 21 A	—	18-7858	18-3081 ④ 18-3075 ⑤	18-15460
AQD 21 B	—	18-7858	18-3081 ④ 18-3075 ⑤	18-15460
MD 21 B	—	18-7858	18-3081 ④ 18-3075 ⑤	18-15460
AQD 32 A	—	18-7858	18-3077	—
MD 32 A	—	18-7858	18-3077	—
MD 30 A	18-7878-1	—	18-3077	—
TMD 30 A	18-7878-1	—	18-3077	—
TAMD 30 A	18-7878-1	—	18-3077	—
AQAD 30 A	18-7878-1	—	18-3077	—
MD 31 A	18-7878-1	—	18-3077	—
TMD 31 A	18-7878-1	—	18-3077	—
AQAD 31 A	18-7878-1	—	18-3077	—
AD 31 A	18-7878-1	—	18-3077	—
TMD 31 B	18-7878-1	—	18-3077	—
TAMD 31 B	18-7878-1	—	18-3077	—
AD 31 B	18-7878-1	—	18-3077	—

Modelo aplic.	Filtro aceite	Filtro comb.	Impulsor	Correa
TMD 31 D	18-7878-1	—	18-3077	—
TAMD 31 D	18-7878-1	—	18-3077	—
AD 31 D	18-7878-1	—	18-3077	—
AD 31 XD	18-7878-1	—	18-3077	—
TMD 31 L-A	18-7878-1	—	18-3077	—
TAMD 31 P,L,M-A	18-7878-1	—	18-3077	—
AD 31 P,L-A	18-7878-1	—	18-3077	—
MD 40 A	—	—	18-3077	—
TMD 40 A	—	—	18-3077	—
AQD 40 A	—	—	18-3077	—
TAMD 40 A	—	—	18-3078	—
AQAD 40 A	—	—	18-3078	—
TMD 40 B	—	—	18-3077	—
TAMD 40 B	—	—	18-3078	—
AQAD 40 B	—	—	18-3078	—
TMD 40 C	—	—	18-3077	—
TMD 41 A	—	—	18-3077	—
AQD 41 A	—	—	18-3077	—
D 41 A	—	—	18-3077	—
TAMD 41 A	—	—	18-3077	—
AQAD 41 A	—	—	18-3077	—
AD 41 A	—	—	18-3077	—
TMD 41 B	—	—	18-3077	—
D 41 B	—	—	18-3077	—
TAMD 41 B	—	—	18-3077	—
AD 41 B	—	—	18-3077	—
KAMD 42 A	—	—	18-3077	—
KAD 42 A	—	—	18-3077	—
TMD 41 D	—	—	18-3077	—
D 41 D	—	—	18-3077	—
TAMD 41 D	—	—	18-3077	—
AD 41 D	—	—	18-3077	—
TMD 41 L-A	—	—	18-3077	—
D 41 L-A	—	—	18-3077	—
TAMD 41 P,L,M,H-A	—	—	18-3077	—
KAMD 42 B	—	—	18-3077	—
KAD 42 B	—	—	18-3077	—
KAMD 42 P-A	—	—	18-3077	—
KAD 42 P-A	—	—	18-3077	—

- ② S/N 14016 & sup
- ③ S/N 4211- & sup
- ④ S/N 103386 & inf
- ⑤ S/N 103387 & sup

 <p>18-5246 KIT ENCENDIDO Para: Distribuidores Delco HVS V-6</p>	 <p>18-5247 KIT ENCENDIDO Reemplaza: 898253T29 Para : Distribuidores Delco HVS V-8</p>	 <p>18-5256 KIT ENCENDIDO — CONTIENE — Ref # O.E. # Descripción 18-5314 835304 Platinos 18-5338 835308-8 Condensador 18-5411 841243 Rotor</p>	 <p>18-5260 KIT ENCENDIDO — CONTIENE — Ref # O.E. # Descripción 18-5303 835705, 855846-2 Platinos 18-5345 835704 Condensador 18-5403 855845 Rotor Prestolite</p>	
 <p>18-5264 KIT ENCENDIDO — CONTIENE — Ref # O.E. # Descripción 18-5303 835705, 855846-2 Platinos 18-5345 835704 Condensador 18-5425 834975 Rotor V-8 Prestolite con tapa de clip</p>	 <p>18-5265 KIT ENCENDIDO — CONTIENE — Ref # O.E. # Descripción 18-5305 243799, 1306169, Platinos 243460 18-5348 834560 Condensador 18-5428 243903 Rotor</p>	 <p>18-5266 KIT ENCENDIDO Para: Distribuidor Flame Thrower 18-5481, 18-5482, 18-5483, 18-5477, 18-5478, 18-5479</p>	 <p>18-5284 KIT ENCENDIDO — CONTIENE — Ref # O.E. # Descripción 18-5305 243799, 1306169, Platinos 243460 18-5349 841262 Condensador 18-5428 243903 Rotor Bosch 4 cil.</p>	
 <p>18-5303 JUEGO DE PLATINOS Reemplaza: 835705, 855846-2</p>	 <p>18-5305 JUEGO DE PLATINOS Reemplaza: 241664, 243460, 243799, 1306169</p>	 <p>18-5306 JUEGO PLATINOS Reemplaza: 240149</p>	 <p>18-5314 JUEGO PLATINOS Reemplaza: 835304</p>	 <p>18-5319 KIT DE PLATINOS Reemplaza: 243801</p>
 <p>PRONAUTIC MARINE EQUIPMENT</p>	 <p>18-5310 JUEGO DE CONTACTOS Reemplaza: 818701-5</p>	 <p>18-5338 CONDENSADOR Reemplaza: 835308</p>	 <p>18-5342 CONDENSADOR Reemplaza: 243653</p>	 <p>18-5345 CONDENSADOR Reemplaza: 835704</p>
 <p>18-5349 CONDENSADOR Reemplaza: 841262 Para: Distribuidores Bosch</p>	 <p>18-5348 CONDENSADOR Reemplaza: 834560</p>	 <p>18-5245 ROTOR Reemplaza: 3858977 Para: Distribuidores Delco HVS</p>	 <p>18-5402 ROTOR Reemplaza: 3862014 Para: Distribuidores Delco EST V-8</p>	 <p>18-5403 ROTOR Reemplaza: 855845, 841907, 3853801</p>

APLICACIONES EMPIEZAN EN LA PÁGINA 288

① Referencias acabadas en "D" envasadas - Referencia normal no envasada

 <p>18-5404-1 ROTOR</p>	 <p>18-5405 ROTOR Reemplaza: 33854549, 3862014 V-8 Para nuevos estilos GM "Tapa modulo"</p>	 <p>18-5406 ROTOR Reemplaza: 3854261 Para: 3.0L Delco EST "Tapa modulo"</p>	 <p>18-5408 ROTOR Reemplaza: 3854311 Para: 4.3L V6 Delco EST "Tapa modulo"</p>	 <p>18-5411 ROTOR Reemplaza: 841243</p>
 <p>18-5413 ROTOR Reemplaza: 3854218 Para: 5.0L FI, FL, 5.8L FL, FI, FSI</p>	 <p>18-5419 ROTOR Reemplaza: 818525</p>	 <p>18-5425 ROTOR Reemplaza: 834975</p>	 <p>18-5428 ROTOR Reemplaza: 243903</p>	 <p>18-29322 KIT TAPA Y ROTOR Reemplaza: 3854217, 3854215 Para: distribuidores Ford HEI</p>
 <p>18-5248 TAPA DISTRIBUIDOR Reemplaza: 3854217 Para: 5.0FIPMDA, 5.0FIPMDM, 5.8FIPMDA, 5.8FIPMDM, 5.0FIPHUCCE, 5.0FIPHUCCE, 5.0FIPHUCE, 5.0FIPHURCE, 5.0FIPHUSCE, 5.0FLPHUB, 5.0FLPHUC, 5.0FLPHUE, 5.0FLPHUR, 5.0FLPHUS, 5.8FIHU, 5.8FIP</p>	 <p>18-5301 KIT ENCENDIDO Reemplaza: Para: Tapa macho distribuidores v-8</p>	 <p>18-5302 KIT ENCENDIDO Reemplaza: Para: Tapa macho distribuidores v-8 flamethrower</p>	 <p>18-5352 TAPA DISTRIBUIDOR Reemplaza: 841070, 3853815</p>	 <p>18-5353 TAPA DISTRIBUIDOR Reemplaza: 841926</p>
 <p>18-5354 TAPA DISTRIBUIDOR Reemplaza: 3854548 Para: V-8 GM Delco EST "Modulo en tapa"</p>	 <p>18-5356 TAPA DISTRIBUIDOR Reemplaza: 243797 Bosch</p>	 <p>18-5357 TAPA DISTRIBUIDOR Reemplaza: 243632, 870690, 1243632</p>	 <p>18-5358 TAPA DISTRIBUIDOR Reemplaza: 841263 Bosch</p>	 <p>18-5361 TAPA DISTRIBUIDOR Reemplaza: 3854260 Para: 3.0L Delco EST "Tapa modulo"</p>
 <p>18-5362 TAPA DISTRIBUIDOR Reemplaza: 3854331 Para: 4.3L V6 Delco EST "Tapa modulo"</p>	 <p>18-5369 TAPA DISTRIBUIDOR Reemplaza: 835702 con junta 18-5399</p>	 <p>18-5375 TAPA DISTRIBUIDOR Reemplaza: 841244</p>	 <p>18-5393 TAPA DISTRIBUIDOR Reemplaza: 241669</p>	 <p>18-5394 TAPA DISTRIBUIDOR Reemplaza: 243658</p>

 <p>18-5473 TAPA DISTRIBUIDOR Tapa distribuidor negra con terminales macho para distribuidores flame thrower</p>	 <p>18-5474 TAPA DISTRIBUIDOR Tapa distribuidor roja con terminales macho para distribuidores flame thrower</p>	 <p>18-5243 TAPA DISTRIBUIDOR Reemplaza: 3859019 Para: Distribuidores Delco HVS V-6</p>	 <p>18-5244 TAPA DISTRIBUIDOR Reemplaza: 3858975 Para: Distribuidores Delco HVS V-8</p>	 <p>18-7492 BOBINA Reemplaza: 3854161 Para: Aplicaciones 1996</p>
 <p>18-7493 BOBINA Reemplaza: 3859078 Para: 8.1L 2001-2007</p>	 <p>18-5745 BOBINA ENCENDIDO Reemplaza: 3287677 Para: AQ171A, AQ171C 251A (1988-92)</p>	 <p>18-7648 BOBINA ENCENDIDO Reemplaza: 3861267 Para: 8.1Gi-A, 8.1Gi-B, 8.1Gi-BF, 8.1Gi-C, 8.1Gi-CF, 8.1Gi-D, 8.1Gi-DF, 8.1GSI-A, 8.1GXI-A, 8.1GXI-AF, 8.1GXI-B, 8.1GXI-BF, 8.1GXI-C</p>	 <p>18-5433 BOBINA ENCENDIDO Reemplaza: 835998 Usa resistencia externa</p>	 <p>18-5436 BOBINA ENCENDIDO 3.0 ohm Reemplaza: 35254 Usa resistencia externa</p>
 <p>18-5437 BOBINA ENCENDIDO Reemplaza: 3852217 Metalica - 12 Volt Usa resistencia externa (Para todas las aplicaciones) Para: Para colas 1990 ant. con punto de encendido</p>	 <p>18-5467 BOBINA ENCENDIDO Reemplaza: 21436799 Para: Motores equipados con distribuidor delco HVS con soporte extensible</p>	 <p>18-5443 BOBINA ENCENDIDO Reemplaza: 3854002 3.0L/4.3L/5.7L/7.4L</p>	 <p>18-5107-1 MODULO ENCENDIDO Reemplaza: 3854003</p>	 <p>18-5108 SENSOR Reemplaza 3854001 Para: GM EST</p>
 <p>18-7757 SENSOR DE POSICIÓN Reemplaza: 3855296 Para: 1995-2001</p>	 <p>18-7642 SENSOR DELCO Reemplaza: 3863130 Para: 3.0, 4.3, 5.0, 5.7L modelos (2002-07)</p>	 <p>18-7643 SENSOR CIGÜEÑAL 3-Pasador Reemplaza: 3859082 Para: 8.1Gi-A, 8.1Gi-B, 8.1Gi-BF, 8.1Gi-C, 8.1Gi-CF, 8.1Gi-D, 8.1Gi-DF, 8.1GSI-A, 8.1GXI-A, 8.1GXI-AF, 8.1GXI-B, 8.1GXI-BF, 8.1GXI-C, 8.1Gi-E, 8.1Gi-EF, 8.1GXI-D, 8.1GXI-DF, 8.1OSI-A, 8.1OSI-AF, 8.1GII-E, 8.1GXII-D (2001-07)</p>	 <p>18-7706 SENSOR POSICIÓN CIGÜEÑAL Reemplaza: 3858979 Para: modelos 4.3, 5.0, 5.7L</p>	
<p>CARACTERÍSTICAS</p> <ul style="list-style-type: none"> ★ Relleno con aceite para mejor refrigeración y gran durabilidad ★ Baja resistencia que produce una gran intensidad para un mejor encendido y economía de combustible ★ Mas hilos internos maximizan la potencia y la fiabilidad sobre el rango de las RPM ★ Se ajusta a los soportes existentes para una fácil instalación 				
 <p>18-5466 BOBINA ENCENDIDO ALTO RENDIMIENTO 1.5 ohm (filtro aceite), negro - 8 cilindro: Flame-Thrower 40,000 volt bobina. ★ Diseñado para uso con kit de encendido de con electrónica original ★ Puede ser usado con otros sistemas de encendido</p>	 <p>18-5469 BOBINA ENCENDIDO ALTO RENDIMIENTO 3.0 ohm (aceite filtro), negro - 4 & 6 cilindro: Flame-Thrower 40,000 volt bobina. ★ Diseñado para uso con kit de encendido de con electrónica original ★ Puede ser usado con otros sistemas de encendido</p>	 <p>18-5472 BOBINA ENCENDIDO ALTO RENDIMIENTO 0.6 ohm (filtro aceite), black - 4, 6, & 8 cilindro: Flame-Thrower 45,000 volt bobina. ★ Resistencia bobina 0.6 ohm diseñada para utilizar con kits de altas prestaciones. ★ Compatible con sistemas de descarga.</p>		
<p>APLICACIONES EMPIEZAN EN LA PÁGINA 288</p>				

Ref #	Descripción	Bobina recomendada	Resistencia Ohms	Ref #	Descripción	Bobina recomendada	Resistencia Ohms
18-5294	Kit conversión electrónica	18-5469	3.0	18-5286	Kit conversión electrónica altas prest.	18-5472	0.6
18-5295	Kit conversión electrónica	18-5469	3.0	18-5289	Kit conversión electrónica altas prest.	18-5472	0.6
18-5299	Kit conversión electrónica	18-5466	1.5	18-5483	Distribuidor Flame-Thrower	18-5472	0.6



FEATURES

- ★ **Ajuste del encendido**
- ★ **Larga vida**
- ★ **Máxima potencia y prestaciones**

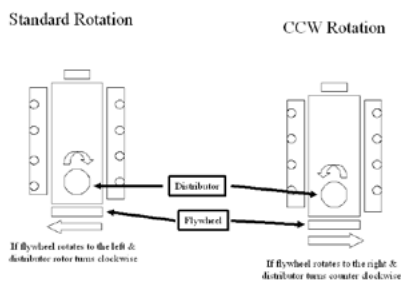

18-5483
DISTRIBUIDOR ELECTRÓNICO ALTAS PREST.
 Para: Chevrolet Marine bloques grandes y pequeños (Altura cubierta standard)
 Reemplaza kit tapa/rotor 18-5266



18-5498-2
DISTRIBUIDOR
 Reemplaza: 9-26307; Mallory YLM624BV
 Para GM V8, 482, 502, 540 CID (Excepto 348, 409 y bloque grande para cubierta alta)



18-5475
DISTRIBUIDOR
 Para: 4 Cil GM con Delco EST encendido 18-5280



18-5476
DISTRIBUIDOR
 Para: Motores GM V6 con encendido Delco EST HEI kit encendido 18-5278



18-5484-1
DISTRIBUIDOR ELECTRÓNICO (Último modelo HEI)
 Reemplaza: 3857449
 Para rotación convencional V8/LH 262-454 & 502
 (Excepto 348/409 y bloques grandes)
 • Diseñado como reemplazo de enchufe para distribuidores de combustible con sistemas de inyección GM-style
 Tune-Up Kit 18-5281
 — CONTIENE —
 Descripción Ref #
 Tapa distribuidor 18-5354
 Rotor 18-5405



18-5494-2
DISTRIBUIDOR ELECTRÓNICO
 Reemplaza: Mallory YLM624AV
 Rotación convencional
 Para todos Chevrolet V8 incluye 482, 502, 540 CID (Excepto 348,409 & bloque grande para cubierta alta)

— CONTIENE —

Ref #	Descripción
18-5376	Tapa distribuidor
18-5488	Modulo
18-5404-1	Rotor



18-5480
KIT CONVERSIÓN ENCENDIDO
 Para: GM SB & BB con altura de cubierta standard

— CONTIENE —

Ref #	Descripción
18-5472	Bobina
18-8803-2	Cableado
18-5483	Distribuidor



18-5477
DISTRIBUIDOR ELECTRÓNICO
 Para: Motores Ford 302 V-8
 Reemplaza Kit tapa/Rotor 18-5266



18-5478
DISTRIBUIDOR ELECTRÓNICO
Para: motores Chrysler LA series V-8
Reemplaza kit tapa/Rotor 18-5266



18-5479
DISTRIBUIDOR ELECTRÓNICO
Para: Motor GM V-8 -rotación reverso
Reemplaza kit tapa/Rotor 18-5266

Ignitor® II

ELECTRONIC IGNITION

CARACTERÍSTICAS

- ★ *Ajuste al pico motor.*
- ★ *Desarrolla de media, 4 veces más energía entre 3.000 y 5.000 RPM.*
- ★ *Larga vida.*
- ★ *usar con 18-5472 para un óptimo rendimiento.*



18-5240
KIT CONVERSIÓN ELECTRÓNICA ALTO RENDIMIENTO
Para: Distribuidores prestolite IDU-7801



18-5288
KIT ELECTRÓNICO ALTO RENDIMIENTO
Para: Mayoría Distribuidores Prestolite V-8 con tapa fijada con clips



18-5289
KIT CONVERSIÓN ELECTRÓNICA ALTO RENDIMIENTO
Para: Mayoría de distribuidores Prestolite V-8 con tapa fijada con tornillos



CARACTERÍSTICAS

- ★ *Reemplaza platinos y condensador par aun buen encendido.*
- ★ *Usa bobina, tapa y rotor standard.*
- ★ *Fácil de instalar, una pieza, 2-conexiones de cables.*
- ★ *Tolerancia de 1/4° en el encendido de 0 a 6000 RPM.*

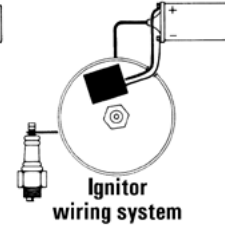
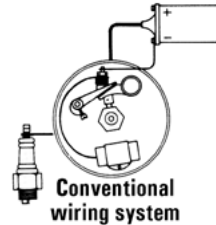

18-5239
KIT CONVERSIÓN ELECTRÓNICA
Para: Distribuidores Prestolite IDU-7801



18-5292
KIT CONVERSIÓN ELECTRÓNICA
Para: 4 Cilindro Volvo AQ Modelos con encendido Bosch (Dist # 0231178017)



18-5294
KIT CONVERSIÓN ELECTRÓNICA
Para: (6 Cil.) distribuidores Delco



18-5295
KIT CONVERSIÓN ELECTRÓNICA
Para: Mayoría 4 Cil. Prestolite distributores (excepto IBM7026) Para: Onan, Universal, Waukesha, Wisconsin



18-5299
KIT CONVERSIÓN ELECTRÓNICA
Para: 8 (Cil.) AQ200A, B, AQ225A, B y Todos 8 Cil. con Prestolite Dist # IBM-7013A Usar con rotor 18-5403 style

① Referencias acabadas en "D" envasadas - Referencias normales no envasadas

APLICACIONES EMPIEZAN EN LA PÁGINA 288

CABLES DE ENCENDIDO

Sierra MAGFORCE Cables de encendido electrónica protege todos tus dispositivos electrónicos y los controles electrónicos del motor de RFI y EMI, además de ofrecer la máxima cantidad de tensión. Ajuste exacto el diseño asegura una fácil instalación - servicio gratuito.

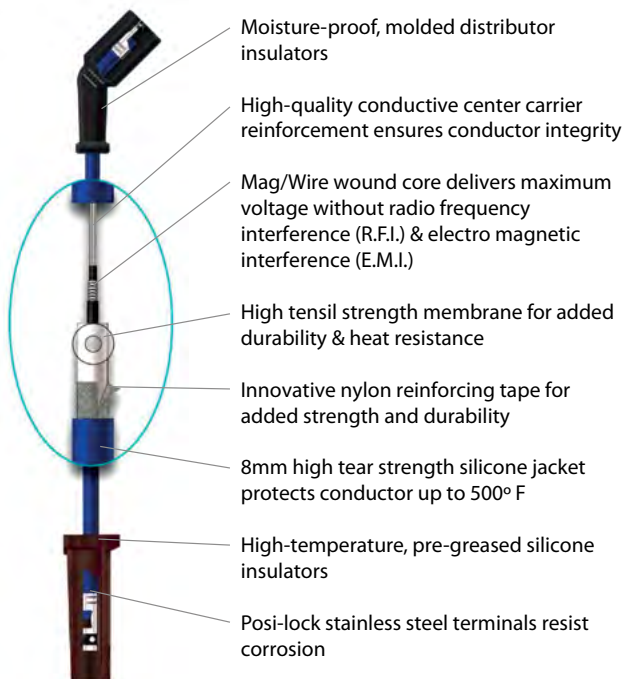

VOLVO PENTA
Sistema encendido

APLICACIONES CABLES ENCENDIDO VOLVO MARINE

Modelo	Cil.	Distribuidor	Año inicio	Año final	enchufe cable
AQ115A, B	4	Volvo	1969	1975	18-28050
AQ120B	4	Volvo	1977	1980	18-8813-1
AQ125A, B	4	Volvo	1981	1985	18-8813-1
AQ130A, B, C, D	4	Volvo	1968	1977	18-28050
AQ131A, B, C, D	4	Volvo	1985	1989	18-8813-1
AQ140A	4	Volvo	1975	1979	18-8813-1
AQ145A, B	4	Volvo	1979	1985	18-8813-1
AQ151A, B, C	4	Volvo	1985	1989	18-8813-1
AQ175A	6	Volvo	1981	1985	18-8801-1
AQ190A	8	Volvo	1976	1977	18-8802-1
AQ200B	8	Mallory (tapa alta)	1974	1976	18-8802-1
AQ200B	8	Mallory (tapa plana)	1974	1976	18-8823-1
AQ200C	8	Mallory (tapa alta)	1976	1977	18-8802-1
AQ200C	8	Mallory (tapa alta)	1976	1977	18-8823-1
AQ205A	6	Volvo	1988	1989	18-8801-1
AQ211A	8	Volvo	1986	1989	18-8802-1
AQ225B	8	Mallory (tapa alta)	1974	1976	18-8802-1
AQ225B	8	Mallory (tapa plana)	1974	1976	18-8823-1

APLICACIONES CABLES ENCENDIDO VOLVO MARINE

Modelo	Cil.	Distribuidor	Año inicio	Año final	enchufe cable
AQ231A, B	8	Volvo	1986	1989	18-8802-1
AQ240A	8	Volvo	1976	1977	18-8802-1
AQ255A	8	Mallory (Tapa plana)	1977	1978	18-8823-1
AQ255B	8	Mallory (tapa alta)	1978	1978	18-8802-1
AQ255B	8	Mallory (Tapa alta)	1978	1978	18-8823-1
AQ260A	8	Mallory (Tapa alta)	1979	1985	18-8802-1
AQ260A	8	Mallory (tapa plana)	1979	1985	18-8823-1
AQ260B	8	Mallory (tapa alta)	1985	1986	18-8802-1
AQ271A, B, C, D	8	Volvo	1986	1989	18-8802-1
AQ280A	8	Mallory (tapa alta)	1978	1979	18-8802-1
AQ280A	8	Mallory (tapa alta)	1978	1979	18-8823-1
AQ290A	8	Mallory (tapa alta)	1979	1985	18-8802-1
AQ290A	8	Mallory (Flat Cap)	1979	1985	18-8823-1
AQ311A, B	8	Volvo	1986	1989	18-8802-1
BB140A	4	Volvo	1975	1979	18-8813-1
BB145A	4	Volvo	1979	1985	18-8813-1
BB225A, AV, B, C	8	Volvo	1973	1977	18-8802-1
BB231A	8	Volvo	1987	1987	18-8802-1

APLICACIÓN CONTINUAN EN LA SIGUIENTE PÁGINA

APLICACIONES CABLES ENCENDIDO VOLVO MARINE

Modelo	Cil.	Distribuidor	Año inicio	Año final	enchufe cable
BB260A, AV, B, C	8	Volvo	1978	1985	18-8802-1
BB261A	8	Volvo	1988	1989	18-8802-1
230A, B	4	Volvo	1989	1992	18-8813-1
250A, B	4	Volvo	1989	1992	18-8813-1
432A	6	Delco EST	1992	1993	18-8835-1
434A	6	Delco EST	1992	1993	18-8835-1
3.0GLM	4	Delco EST	1993	1994	18-8833-1
3.0GLM	4	Delco EST	2002	2004	18-8833-1
3.0GLP	4	Delco EST	2002	2010	18-8833-1
3.0GSM	4	Delco EST	1994	2002	18-8833-1
3.0GSP	4	Delco EST	1993	2002	18-8833-1
3.0GXI	4	Delco EST	2008	2009	18-8833-1
4.3GI	6	Delco EST	1994	2000	18-8835-1
4.3GL	6	Delco EST	1993	2010	18-8835-1
4.3GS	6	Delco EST	1993	1999	18-8835-1
4.3GXI	6	Delco HVS	2001	2015	18-8829-1
4.3GXI	6	Delco EST	2001	2002	18-8835-1
4.3GXIE	6	Delco HVS	2009	2015	18-8829-1
4.3SI	6	Delco HVS	2001	2009	18-8829-1
4.3SI-BF	6	Delco HVS	2001	2002	18-8829-1
5.0FI	8	Ford	1994	1996	18-8820-1
5.0FL	8	Prestolite	1994	1996	18-8802-1
5.0GI	8	Delco EST	1997	2000	18-8836-1
5.0GL	8	Prestolite	1997	2001	18-8802-1
5.0GL	8	Delco EST	2001	2006	18-8836-1
5.0GXI	8	Delco HVS	2001	2015	18-8828-1
5.0GXI-A	8	Delco EST	2001	2002	18-8836-1
5.0GXIC	8	Delco HVS	2007	2009	18-8828-1
5.0GXIE	8	Delco HVS	2007	2015	18-8828-1
5.00SI	8	Delco HVS	2001	2009	18-8828-1
5.00SiE	8	Delco HVS	2008	2009	18-8828-1
5.7GI	8	Delco EST	1993	1997	18-8836-1
5.7Gi	8	Delco HVS	2001	2015	18-8828-1
5.7GI	8	Delco EST	2004	2005	18-8836-1
5.7GiC	8	Delco HVS	2008	2009	18-8828-1
5.7GiCE	8	Delco HVS	2008	2009	18-8828-1
5.7GiE	8	Delco HVS	2007	2015	18-8828-1
5.7GIL	8	Delco HVS	2002	2009	18-8828-1
5.7GIL-A	8	Delco EST	2001	2001	18-8836-1
5.7GL	8	Prestolite	1993	1997	18-8802-1
5.7GL	8	Delco EST	1993	1997	18-8836-1
5.7GL	8	Delco EST	2001	2004	18-8836-1
5.7GL-A	8	Mallory	2001	2001	18-8802-1
5.7GSI	8	Delco EST	1996	2001	18-8836-1
5.7GSP	8	Prestolite	1996	2000	18-8802-1

APLICACIONES CABLES ENCENDIDO VOLVO MARINE

Modelo	Cil.	Distribuidor	Año inicio	Año final	enchufe cable
5.7GXl	8	Delco HVS	2001	2015	18-8828-1
5.7GXl-A, B	8	Delco EST	2000	2002	18-8836-1
5.7GXIC	8	Delco HVS	2007	2008	18-8828-1
5.7GXICE	8	Delco HVS	2007	2010	18-8828-1
5.7GXIE	8	Delco HVS	2007	2015	18-8828-1
5.7GXIL	8	Delco HVS	2001	2008	18-8828-1
5.7GXIL-A, B	8	Delco EST	2000	2002	18-8836-1
5.70Si	8	Delco HVS	2001	2009	18-8828-1
5.70SiE	8	Delco HVS	2008	2009	18-8828-1
5.70SXI	8	Delco HVS	2001	2009	18-8828-1
5.70SXiE	8	Delco HVS	2008	2009	18-8828-1
5.8FI	8	Ford	1994	1996	18-8820-1
5.8FL	8	Prestolite	1994	1996	18-8803-1
5.8FSI	8	Prestolite	1994	1996	18-8803-1
7.4GI	8	Delco EST	1994	2000	18-8836-1
7.4GL	8	Prestolite	1993	1997	18-8802-1
7.4GLI	8	Prestolite	1993	1996	18-8802-1
7.4GLP	8	Prestolite	1993	1997	18-8802-1
7.4GLP	8	Prestolite	1994	1997	18-28051
7.4GLP	8	Delco EST	1995	1996	18-8836-1
7.4GSI	8	Delco EST	1994	2000	18-8836-1
8.1Gi-A	8	Distributorless	1999	2015	18-8838-1
8.1GiC	8	Distributorless	2007	2015	18-8838-1
8.1GiCE	8	Distributorless	2007	2015	18-8838-1
8.1GiE	8	Distributorless	2007	2015	18-8838-1
8.1GiL	8	Distributorless	2000	2008	18-8838-1
8.1GSI	8	Distributorless	2000	2001	18-8838-1
8.1GXi	8	Distributorless	2001	2015	18-8838-1
8.1GXIE	8	Distributorless	2007	2015	18-8838-1
8.1GXil	8	Distributorless	2001	2008	18-8838-1
8.1IPSCe	8	Distributorless	2008	2015	18-8838-1
8.1OSI	8	Distributorless	2003	2009	18-8838-1
8.1OSiE	8	Distributorless	2008	2009	18-8838-1
8.2GLI	8	Prestolite	1993	1994	18-8803-1
8.2GLP	8	Prestolite	1993	1994	18-8803-1
8.2GSI	8	Delco EST	1995	2000	18-8836-1
DPX375	8	Distributorless	2000	2002	18-8838-1
DPX385	8	Delco EST	1996	2000	18-8836-1
DPX415	8	Delco EST	1996	2000	18-8836-1
DPX420	8	Distributorless	2000	2002	18-8838-1
V6-200	6	Delco HVS	2012	2015	18-8828-1
V6-225	6	Delco HVS	2012	2015	18-8828-1
V8-270	8	Delco HVS	2012	2015	18-8829-1
V8-300	8	Delco HVS	2012	2015	18-8829-1
V8-320	8	Delco HVS	2012	2015	18-8829-1

Sistema encendido
VOLVO PENTA



CABLES BATERÍA
Con cables soldados para 3/8" .

Ref No.	Tam	Color	Cal
BC88523	2'	rojo	4
BC88533	2'	negro	4
BC88543	4'	rojo	2
BC88553	4'	negro	2
BC88563	6'	rojo	2
BC88573	6'	negro	2
BC88583	8'	rojo	1
BC88593	8'	negro	1



18-5225

KIT CABLE BUJÍAS

Reemplaza: Mercury 84-99215A26,
84-813706A26

Kit incluye 25 pies de cable de 7mm Hypalon de alma de cobre y un amplio surtido de 3 terminales.

 <p>18-5226 CABLE ENCENDIDO Alma metálica 100' bobina 7mm Hypalon</p>	 <p>18-26810 GM HEI 4 TERMINAL PIGTAIL Para: GM HEI Distribuidores con 4 terminales</p>	 <p>18-26811 GM HEI 2 TERMINAL PIGTAIL Para: GM HEI Distribuidores con 2 terminales</p>	 <p>18-26812 CONECTOR BOBINA HEI</p>	 <p>18-26813 CONECTOR BOBINA HEI</p>
<p>PACK. DE 10</p>  <p>18-5224 18-5224-9① CABLE TERMINAL ENCENDIDO Reemplaza: Mercury 20121 OMC 510364</p>	<p>PACK. DE 10</p>  <p>18-5750 18-5750-9① TAPA BUJÍAS UNIVERSAL Suministrado completo con conector terminal Replaces: OMC 581027, 580339</p>	 <p>18-5752 TAPA BUJÍAS UNIVERSAL 8mm</p>	 <p>18-5657 TAPA BUJÍAS UNIVERSAL Reemplaza: 855798 Para: Mayoría motores Volvo gas & diesel</p>	

① Precio por pack

APLICACIÓN ENCENDIDO VOLVO PENTA

Modelo	Distribuidor	Kit cable bujías	Tapa distrib.	Rotor	bobina picado	ICM	Bobina encendido	Condensador	Puntos de contacto	Kit encendido
AQ100	BOSCH	-	18-5357	18-5428	N/D	N/D	18-5436	18-5342	18-5306	-
AQ110	BOSCH	-	18-5357	18-5428	N/D	N/D	18-5436	18-5342	18-5306	-
AQ115A	0231153010	18-28050	18-5357	18-5428	N/D	N/D	18-5436	-	18-5305	-
AQ115A	0231153012	18-28050	18-5356	18-5428	N/D	N/D	18-5436	-	18-5305	-
AQ115B	0231153010	18-28050	18-5357	18-5428	N/D	N/D	18-5436	-	18-5305	-
AQ115B	0231153012	18-28050	18-5356	18-5428	N/D	N/D	18-5436	-	18-5305	-
AQ120	BOSCH	-	18-5357	18-5428	N/D	N/D	18-5436	18-5342	18-5306	-
AQ120B	0231178017	18-8813-1	18-5358	18-5428	N/D	N/D	18-5436	18-5349	18-5305	18-5284
AQ120B	0231178016	18-8813-1	18-5356	18-5428	N/D	N/D	18-5436	18-5349	18-5305	18-5284
AQ120B	0231178018	18-8813-1	18-5356	18-5428	N/D	N/D	18-5436	18-5349	18-5305	18-5284
AQ125A	TODOS	18-8813-1	18-5358	18-5428	N/D	N/D	18-5436	18-5349	18-5305	18-5284
AQ125B	TODOS	18-8813-1	18-5358	18-5428	N/D	N/D	18-5436	18-5349	18-5305	18-5284
AQ130A	0231153010	18-28050	18-5357	18-5428	N/D	N/D	18-5436	-	18-5305	-
AQ130A	0231153012	18-28050	18-5356	18-5428	N/D	N/D	18-5436	-	18-5305	-
AQ130B	0231153010	18-28050	18-5357	18-5428	N/D	N/D	18-5436	-	18-5305	-
AQ130B	0231153012	18-28050	18-5356	18-5428	N/D	N/D	18-5436	-	18-5305	-
AQ130C	0231153010	18-28050	18-5357	18-5428	N/D	N/D	18-5436	-	18-5305	-
AQ130C	0231153012	18-28050	18-5356	18-5428	N/D	N/D	18-5436	-	18-5305	-
AQ130D	0231153010	18-28050	18-5357	18-5428	N/D	N/D	18-5436	-	18-5305	-
AQ130D	0231153012	18-28050	18-5356	18-5428	N/D	N/D	18-5436	-	18-5305	-
AQ131A	TODOS	18-8813-1	18-5358	18-5428	N/D	N/D	18-5436	-	18-5305	-
AQ131B	TODOS	18-8813-1	18-5358	18-5428	N/D	N/D	18-5436	-	18-5305	-
AQ131C	TODOS	18-8813-1	18-5358	18-5428	N/D	N/D	18-5436	-	18-5305	-
AQ131D	TODOS	18-8813-1	18-5358	18-5428	N/D	N/D	18-5436	-	18-5305	-
AQ140A	0231178017	18-8813-1	18-5358	18-5428	N/D	N/D	18-5436	18-5349	18-5305	18-5284
AQ140A	0231178016	18-8813-1	18-5356	18-5428	N/D	N/D	18-5436	18-5349	18-5305	18-5284
AQ140A	0231178018	18-8813-1	18-5356	18-5428	N/D	N/D	18-5436	18-5349	18-5305	18-5284
AQ145A	TODOS	18-8813-1	18-5358	18-5428	N/D	N/D	18-5436	18-5349	18-5305	18-5284
AQ145B	TODOS	18-8813-1	18-5358	18-5428	N/D	N/D	18-5436	18-5349	18-5305	18-5284
AQ151A	TODOS	18-8813-1	18-5358	18-5428	N/D	N/D	18-5436	18-5349	18-5305	18-5284
AQ151B	TODOS	18-8813-1	18-5358	18-5428	N/D	N/D	18-5436	18-5349	18-5305	18-5284
AQ151C	TODOS	18-8813-1	18-5358	18-5428	N/D	N/D	18-5436	18-5349	18-5305	18-5284
AQ165A	023116054	-	18-5393	18-5428	N/D	N/D	-	-	-	-

APLICACIONES CONTINÚAN EN LA SIGUIENTE PÁGINA

APLICACIÓN ENCENDIDO VOLVO PENTA (Cont.)

Modelo	Distribuidor	Kit cable bujías	Tapa distrib.	Rotor	bobina picado	ICM	Bobina encendido	Condensador	Puntos de contacto	Kit encendido
AQ165A	0231116060		18-5393	18-5428	N/D	N/D		-	-	-
AQ165A	0231121008		18-5393	18-5428	N/D	N/D		-	18-5305	-
AQ165A	0231311002		18-5394	18-5428	N/D	N/D		-	18-5319	-
AQ170A	0231116054		-	18-5428	N/D	N/D		-	-	-
AQ170A	0231116060		-	18-5428	N/D	N/D		-	-	-
AQ170A	0231121008		-	18-5428	N/D	N/D		-	18-5305	-
AQ170A	0231311002		-	-	N/D	N/D		-	18-5319	-
AQ170B	0231116054		-	18-5428	N/D	N/D		-	-	-
AQ170B	0231116060		-	18-5428	N/D	N/D		-	-	-
AQ170B	0231121008		-	18-5428	N/D	N/D		-	18-5305	-
AQ170B	0231311002		-	-	N/D	N/D		-	18-5319	-
AQ170C	0231116054		18-5393	18-5428	N/D	N/D		-	-	-
AQ170C	0231121008		-	18-5428	N/D	N/D		-	18-5305	-
AQ171A	TODOS		-	-	N/D	N/D		N/D	N/D	-
AQ171C	TODOS		-	-	N/D	N/D		N/D	N/D	-
AQ175A	TODOS	18-8801-1	18-5369	18-5425	N/D	N/D	18-5433	18-5345	18-5303	18-5264
AQ190A	TODOS	18-8802-1	18-5369	18-5425	N/D	N/D		18-5345	18-5303	18-5264
AQ200B	MALLORY TAPA PLANA	18-8823-1	18-5375	18-5411	N/D	N/D		18-5338	18-5314	18-5256
AQ200B	MALLORY TAPA ALTA	18-8802-1	18-5352	18-5403	N/D	N/D		18-5345	18-5303	18-5260
AQ200C	MALLORY TAPA PLANA	18-8823-1	18-5375	18-5411	N/D	N/D	18-5433	18-5338	18-5314	18-5256
AQ200C	MALLORY TAPA ALTA	18-8802-1	18-5352	18-5403	N/D	N/D	18-5433	18-5345	18-5303	18-5260
AQ200D	S/N 20459 & INF		18-5369	18-5425	N/D	N/D	18-5433	18-5345	18-5303	18-5264
AQ200D	S/N 20460 & SUP		18-5352	18-5403	N/D	N/D	18-5433	18-5345	18-5303	18-5260
AQ200F	TODOS		18-5352	18-5403	N/D	N/D	18-5433	18-5345	18-5303	18-5260
AQ205A	TODOS	18-8801-1	18-5353	18-5403	N/D	N/D		-	-	-
AQ211A	TODOS	18-8802-1	18-5352	18-5403	N/D	N/D	18-5433	18-5345	18-5303	18-5260
AQ225B	MALLORY TAPA PLANA	18-8823-1	18-5375	18-5411	N/D	N/D		18-5338	18-5314	18-5256
AQ225B	MALLORY TAPA ALTA	18-8802-1	18-5352	18-5403	N/D	N/D		18-5345	18-5303	18-5260
AQ225C	TODOS		18-5375	18-5411	N/D	N/D	18-5433	18-5338	18-5314	18-5256
AQ225D	S/N 20459 & INF		18-5369	18-5425	N/D	N/D	18-5433	18-5345	18-5303	18-5264
AQ225D	S/N 20460 & SUP		18-5352	18-5403	N/D	N/D	18-5433	18-5345	18-5303	18-5260
AQ225E	TODOS		18-5352	18-5403	N/D	N/D	18-5433	18-5345	18-5303	18-5260
AQ225F	TODOS		18-5352	18-5403	N/D	N/D	18-5433	18-5345	18-5303	18-5260
AQ231A	TODOS	18-8802-1	18-5352	18-5403	N/D	N/D	18-5433	18-5345	18-5303	18-5260
AQ231B	TODOS	18-8802-1	18-5352	18-5403	N/D	N/D	18-5433	18-5345	18-5303	18-5260
AQ240A	TODOS	18-8802-1	18-5369	18-5403	N/D	N/D		18-5345	18-5303	18-5260
AQ255A	MALLORY TAPA PLANA	18-8823-1	18-5375	18-5411	N/D	N/D	18-5433	18-5338	18-5314	18-5256
AQ255B	MALLORY TAPA PLANA	18-8823-1	18-5375	18-5411	N/D	N/D	18-5433	18-5338	18-5314	18-5256
AQ255B	MALLORY TAPA ALTA	18-8802-1	18-5352	18-5403	N/D	N/D	18-5433	18-5345	18-5303	18-5260
AQ260A	MALLORY TAPA PLANA	18-8823-1	18-5375	18-5411	N/D	N/D	18-5433	18-5338	18-5314	18-5256
AQ260A	MALLORY TAPA ALTA	18-8802-1	18-5352	18-5403	N/D	N/D	18-5433	18-5345	18-5303	18-5260
AQ260B	MALLORY TAPA ALTA	18-8802-1	18-5352	18-5403	N/D	N/D	18-5433	18-5345	18-5303	18-5260
AQ271A	TODOS	18-8802-1	18-5352	18-5403	N/D	N/D	18-5433	-	-	-
AQ271B	TODOS	18-8802-1	18-5352	18-5403	N/D	N/D		-	-	-
AQ271C	TODOS	18-8802-1	18-5352	18-5403	N/D	N/D		-	-	-
AQ271D	TODOS	18-8802-1	18-5352	18-5403	N/D	N/D		-	-	-
AQ280A	MALLORY TAPA PLANA	18-8823-1	18-5375	18-5411	N/D	N/D	-	18-5338	18-5314	18-5256
AQ280A	MALLORY TAPA ALTA	18-8802-1	18-5352	18-5403	N/D	N/D	-	18-5345	18-5303	18-5260
AQ290A	MALLORY TAPA PLANA	18-8823-1	18-5375	18-5411	N/D	N/D	18-5433	18-5338	18-5314	18-5256
AQ290A	MALLORY TAPA ALTA	18-8802-1	18-5352	18-5403	N/D	N/D	18-5433	18-5345	18-5303	18-5260
AQ311A	TODOS	18-8802-1	18-5352	18-5403	N/D	N/D		-	-	-
AQ311B	TODOS	18-8802-1	18-5352	18-5403	N/D	N/D		-	-	-
AQ60F	BOSCH	-	18-5357	18-5428	N/D	N/D	18-5436	18-5342	18-5306	-
AQ90	BOSCH	-	18-5357	18-5428	N/D	N/D	18-5436	18-5342	18-5306	-
AQ95	BOSCH	-	18-5357	18-5428	N/D	N/D	18-5436	18-5342	18-5306	-
AQ95A	BOSCH	-	18-5357	18-5428	N/D	N/D	18-5436	18-5342	18-5306	-

APLICACIONES CONTINÚAN EN LA SIGUIENTE PÁGINA

APLICACIÓN ENCENDIDO VOLVO PENTA (Cont.)

Modelo	Distribuidor	Kit cable bujías	Tapa distrib.	Rotor	bobina picado	ICM	Bobina encendido	Condensador	Puntos de contacto	Kit encendido
BB100	BOSCH	-	18-5357	18-5428	N/D	N/D	18-5436	18-5342	18-5306	-
BB115A	0231153010	18-28050	18-5357	18-5428	N/D	N/D	18-5436	-	18-5305	-
BB115A	0231153012	18-28050	18-5356	18-5428	N/D	N/D	18-5436	-	18-5305	-
BB115B	0231153010	18-28050	18-5357	18-5428	N/D	N/D	18-5436	-	18-5305	-
BB115B	0231153012	18-28050	18-5356	18-5428	N/D	N/D	18-5436	-	18-5305	-
BB115C	0231153010	18-28050	18-5357	18-5428	N/D	N/D	18-5436	-	18-5305	-
BB115C	0231153012	18-28050	18-5356	18-5428	N/D	N/D	18-5436	-	18-5305	-
BB140A	0231178017	18-8813-1	18-5358	18-5428	N/D	N/D	18-5436	18-5349	18-5305	18-5284
BB140A	0231178016	18-8813-1	18-5356	18-5428	N/D	N/D	18-5436	18-5349	18-5305	18-5284
BB140A	0231178018	18-8813-1	18-5356	18-5428	N/D	N/D	18-5436	18-5349	18-5305	18-5284
BB145A	TODOS	18-8813-1	18-5358	18-5428	N/D	N/D	18-5436	18-5349	18-5305	18-5284
BB165A	0231116054		18-5393	18-5428	N/D	N/D		-	-	-
BB165A	0231116060		18-5393	18-5428	N/D	N/D		-	-	-
BB165A	0231121008		18-5393	18-5428	N/D	N/D		-	18-5305	-
BB165A	0231311002		18-5394	18-5428	N/D	N/D		-	18-5319	-
BB170A	0231116054		18-5393	18-5428	N/D	N/D		-	-	-
BB170A	0231116060		18-5393	18-5428	N/D	N/D		-	-	-
BB170A	0231121008		18-5393	18-5428	N/D	N/D		-	18-5305	-
BB170A	0231311002		18-5394	18-5428	N/D	N/D		-	18-5319	-
BB170B	0231116054		18-5393	18-5428	N/D	N/D		-	-	-
BB170B	0231116060		18-5393	18-5428	N/D	N/D		-	-	-
BB170B	0231121008		18-5393	18-5428	N/D	N/D		-	18-5305	-
BB170B	0231311002		18-5394	18-5428	N/D	N/D		-	18-5319	-
BB170C	0231116054		18-5393	18-5428	N/D	N/D		-	-	-
BB170C	0231116060		18-5393	18-5428	N/D	N/D		-	-	-
BB170C	0231121008		18-5393	18-5428	N/D	N/D		-	18-5305	-
BB170C	0231311002		18-5394	18-5428	N/D	N/D		-	18-5319	-
BB225A	TODOS	18-8802-1	18-5352	18-5403	N/D	N/D	18-5433	18-5345	18-5303	18-5260
BB225AV	TODOS	18-8802-1	18-5352	18-5403	N/D	N/D	18-5433	18-5345	18-5303	18-5260
BB225B	TODOS	18-8802-1	18-5352	18-5403	N/D	N/D	18-5433	18-5345	18-5303	18-5260
BB225C	TODOS	18-8802-1	18-5352	18-5403	N/D	N/D	18-5433	18-5345	18-5303	18-5260
BB231A	TODOS	18-8802-1	18-5352	18-5403	N/D	N/D	18-5433	18-5345	18-5303	18-5260
BB260A	TODOS	18-8802-1	18-5352	18-5403	N/D	N/D	18-5433	18-5345	18-5303	18-5260
BB260AV	TODOS	18-8802-1	18-5352	18-5403	N/D	N/D	18-5433	18-5345	18-5303	18-5260
BB260B	TODOS	18-8802-1	18-5352	18-5403	N/D	N/D	18-5433	18-5345	18-5303	18-5260
BB260C	TODOS	18-8802-1	18-5352	18-5403	N/D	N/D	18-5433	18-5345	18-5303	18-5260
BB261A	TODOS	18-8802-1	18-5352	18-5403	N/D	N/D	18-5433	18-5345	18-5303	18-5260
BB30	BOSCH	-	18-5357	18-5428	N/D	N/D	18-5436	18-5342	18-5306	-
MB10A	TODOS		-	18-5428	N/D	N/D	18-5436	-	18-5305	-
MB18	BOSCH	-	18-5357	18-5428	N/D	N/D	18-5436	18-5342	18-5306	-
MB18F	BOSCH	-	18-5357	18-5428	N/D	N/D	18-5436	18-5342	18-5306	-
MB20A	TODOS		18-5356	18-5428	N/D	N/D	18-5436	-	18-5305	-
MB20B	0231110043	-	18-5357	18-5428	N/D	N/D	18-5436	18-5342	18-5306	-
MB20B	0231178005		18-5356	18-5428	N/D	N/D	18-5436	-	18-5305	-
MB20C	0231110043	-	18-5357	18-5428	N/D	N/D	18-5436	18-5342	18-5306	-
MB20C	0231178005		18-5356	18-5428	N/D	N/D	18-5436	-	18-5305	-
230A	TODOS	18-8813-1	18-5358	18-5428	N/D	N/D	18-5436	18-5349	18-5305	18-5265
230B	TODOS	18-8813-1	18-5358	18-5428	N/D	N/D	18-5436	18-5349	18-5305	18-5265
250A	TODOS	18-8813-1	18-5358	18-5428	N/D	N/D	18-5436	18-5349	18-5305	18-5265
250B	TODOS	18-8813-1	18-5358	18-5428	N/D	N/D	18-5436	18-5349	18-5305	18-5265
251A	TODOS		-	-	N/D	N/D	-	N/D	N/D	N/D
430A	TODOS		18-5353	18-5403	-	N/D	-	N/D	N/D	N/D
430B	TODOS		18-5353	18-5403	-	N/D	-	N/D	N/D	N/D
431A	TODOS		18-5353	18-5403	-	N/D	-	N/D	N/D	N/D
431B	TODOS		18-5353	18-5403	-	N/D	-	N/D	N/D	N/D
432A	DELCO EST	18-8835-1	18-5362	18-5408	18-5108	18-5107-1	-	N/D	N/D	18-5278

APLICACIONES CONTINÚAN EN LA SIGUIENTE PÁGINA

APLICACIÓN ENCENDIDO VOLVO PENTA (Cont.)

Modelo	Distribuidor	Kit cable bujías	Tapa distrib.	Rotor	bobina picado	ICM	Bobina encendido	Condensador	Puntos de contacto	Kit encendido
434A	DELCO EST	18-8835-1	18-5362	18-5408	18-5108	18-5107-1	-	N/D	N/D	18-5278
500A	TODOS		18-5352	18-5403	-	N/D	-	N/D	N/D	N/D
500B	TODOS		18-5352	18-5403	-	N/D	-	N/D	N/D	N/D
501A	TODOS		18-5352	18-5403	-	N/D	-	N/D	N/D	N/D
501A/MS4	TODOS		18-5352	18-5403	-	N/D	-	N/D	N/D	N/D
501B	TODOS		18-5352	18-5403	-	N/D	-	N/D	N/D	N/D
570A	TODOS		18-5352	18-5403	-	N/D	-	N/D	N/D	N/D
571A	TODOS		18-5352	18-5403	-	N/D	-	N/D	N/D	N/D
572A	TODOS		18-5352	18-5403	-	N/D	-	N/D	N/D	N/D
740A	TODOS		18-5352	18-5403	-	N/D	-	N/D	N/D	N/D
740A/MS5	TODOS		18-5352	18-5403	-	N/D	-	N/D	N/D	N/D
740B	TODOS		18-5352	18-5403	-	N/D	-	N/D	N/D	N/D
3.0GL	DELCO EST	18-8841-1	18-5361	18-5406	18-5108	18-5107-1	18-5443	N/D	N/D	18-5280
3.0GS	DELCO EST	18-8841-1	18-5361	18-5406	18-5108	18-5107-1	18-5443	N/D	N/D	18-5280
3.0GXi	DELCO EST	18-8841-1	18-5361	18-5406	18-5108	18-5117	18-5465	N/D	N/D	18-5280
4.3Gi	DELCO HVS	18-8829-1	18-5243	18-5245	18-7642	18-5117	18-5467	N/D	N/D	18-5246
4.3Gi	DELCO EST	18-8835-1	18-5362	18-5408	18-5108	18-5107-1	18-7648	N/D	N/D	18-5278
4.3GL	DELCO EST	18-8835-1	18-5362	18-5408	18-5108	18-5107-1	18-7648	N/D	N/D	18-5278
4.3GS	DELCO EST	18-8835-1	18-5362	18-5408	18-5108	18-5107-1	18-7648	N/D	N/D	18-5278
4.3GXi	DELCO EST	18-8835-1	18-5362	18-5408	18-5108	18-5107-1	18-7648	N/D	N/D	18-5278
4.3GXi	DELCO HVS	18-8829-1	18-5243	18-5245	18-7642	18-5117	18-5467	N/D	N/D	18-5246
4.3Si	DELCO HVS	18-8829-1	18-5243	18-5245	18-7642	18-5117	18-5467	N/D	N/D	18-5246
5.0Fi	FORD	18-8820-1	18-5248	18-5413	-	N/D	18-7492	N/D	N/D	N/D
5.0FL	PRESTOLITE	18-8802-1	18-5352	18-5403	-	N/D	18-5437	N/D	N/D	N/D
5.0GiC	DELCO HVS	18-8828-1	18-5244	18-5245	18-7642	18-5117	18-5467	N/D	N/D	18-5247
5.0Gi	DELCO EST	18-8836-1	18-5354	18-5405	18-5108	18-5107-1	18-7648	N/D	N/D	18-5281
5.0GL	PRESTOLITE	18-8802-1	18-5352	18-5403	-	N/D	18-5437	N/D	N/D	N/D
5.0GL	DELCO EST	18-8836-1	18-5354	18-5405	18-5108	18-5107-1	18-5443	N/D	N/D	18-5281
5.0GXi	DELCO EST	18-8836-1	18-5354	18-5405	18-5108	18-5107-1	18-7648	N/D	N/D	18-5281
5.0GXi	DELCO HVS	18-8828-1	18-5244	18-5245	18-7642	18-5117	18-5467	N/D	N/D	18-5247
5.0GXIE	DELCO HVS	18-8828-1	18-5244	18-5245	18-7642	18-5117	18-5467	N/D	N/D	18-5247
5.00SiE	DELCO HVS	18-8828-1	18-5244	18-5245	18-7642	18-5117	18-5467	N/D	N/D	18-5247
5.00Si	DELCO HVS	18-8828-1	18-5244	18-5245	18-7642	18-5117	18-5467	N/D	N/D	18-5247
5.7Gi	DELCO EST	18-8836-1	18-5354	18-5405	18-5108	18-5107-1	18-7648	N/D	N/D	18-5281
5.7GiC	DELCO HVS	18-8828-1	18-5244	18-5245	18-7642	18-5117	18-5467	N/D	N/D	18-5247
5.7GiCE	DELCO HVS	18-8828-1	18-5244	18-5245	18-7642	18-5117	18-5467	N/D	N/D	18-5247
5.7GiE	DELCO HVS	18-8828-1	18-5244	18-5245	18-7642	18-5117	18-5467	N/D	N/D	18-5247
5.7Gi	DELCO HVS	18-8828-1	18-5244	18-5245	18-7642	18-5117	18-5467	N/D	N/D	18-5247
5.7Gi	DELCO EST	18-8836-1	18-5354	18-5405	18-5108	18-5107-1	18-5443	N/D	N/D	18-5281
5.7GL	MALLORY	18-8802-1	18-5352	18-5403	-	-	-	N/D	N/D	N/D
5.7GL	DELCO EST	18-8836-1	18-5354	18-5405	18-5108	18-5107-1	18-5443	N/D	N/D	18-5281
5.7GL	PRESTOLITE	18-8802-1	18-5352	18-5403	-	N/D	18-5437	N/D	N/D	N/D
5.7GSi	DELCO EST	18-8836-1	18-5354	18-5405	18-5108	18-5107-1	18-5443	N/D	N/D	18-5281
5.7GSii	DELCO EST	18-8836-1	18-5354	18-5405	18-5108	18-5107-1	18-5443	N/D	N/D	18-5281
5.7GSP	PRESTOLITE	18-8802-1	18-5352	18-5403	-	N/D	18-5437	N/D	N/D	N/D
5.7GXi	DELCO EST	18-8836-1	18-5354	18-5405	18-5108	18-5107-1	18-7648	N/D	N/D	18-5281
5.7GXICE	DELCO HVS	18-8828-1	18-5244	18-5245	18-7642	18-5117	18-5467	N/D	N/D	18-5247
5.7GXIC	DELCO HVS	18-8828-1	18-5244	18-5245	18-7642	18-5117	18-5467	N/D	N/D	18-5247
5.7GXIE	DELCO HVS	18-8828-1	18-5244	18-5245	18-7642	18-5117	18-5467	N/D	N/D	18-5247
5.7GXi	DELCO HVS	18-8828-1	18-5244	18-5245	18-7642	18-5117	18-5467	N/D	N/D	18-5247
5.7GXii	DELCO HVS	18-8828-1	18-5244	18-5245	18-7642	18-5117	18-5467	N/D	N/D	18-5247
5.7GXii	DELCO EST	18-8836-1	18-5354	18-5405	18-5108	18-5107-1	18-5443	N/D	N/D	18-5281
5.70Si	DELCO HVS	18-8828-1	18-5244	18-5245	18-7642	18-5117	18-5467	N/D	N/D	18-5247
5.70SXi	DELCO HVS	18-8828-1	18-5244	18-5245	18-7642	18-5117	18-5467	N/D	N/D	18-5247
5.8Fi	FORD	18-8820-1	18-5248	18-5413	-	N/D	18-7492	N/D	N/D	N/D
5.8FL	PRESTOLITE	18-8803-1	18-5352	18-5403	-	N/D	18-5437	N/D	N/D	N/D

APLICACIÓN CONTINÚAN EN LA SIGUIENTE PÁGINA

APLICACIÓN ENCENDIDO VOLVO PENTA (Cont.)

Modelo	Distribuidor	Kit cable bujías	Tapa distrib.	Rotor	bobina picado	ICM	Bobina encendido	Condensador	Puntos de contacto	Kit encendido
5.8FSI	PRESTOLITE	18-8803-1	18-5352	18-5403	-	N/D	18-5437	N/D	N/D	N/D
7.4Gi	DELCO EST	18-8836-1	18-5354	18-5405	18-5108	18-5107-1	18-5443	N/D	N/D	18-5281
7.4GL	PRESTOLITE	18-8802-1	18-5352	18-5403	-	N/D	18-5437	N/D	N/D	N/D
7.4GL	DELCO EST	18-8836-1	18-5354	18-5405	18-5108	18-5107-1	18-5443	N/D	N/D	18-5281
7.4GSI	DELCO EST	18-8836-1	18-5354	18-5405	18-5108	18-5107-1	18-5443	N/D	N/D	18-5281
8.1Gi	DELCO	18-8838-1	N/D	N/D	N/D	N/D	18-7493	N/D	N/D	N/D
8.1Gi-A	DELCO	18-8838-1	N/D	N/D	N/D	N/D	18-7648	N/D	N/D	N/D
8.1Gi-B	DELCO	18-8838-1	N/D	N/D	N/D	N/D	18-7648	N/D	N/D	N/D
8.1Gi-BF	DELCO	18-8838-1	N/D	N/D	N/D	N/D	18-7648	N/D	N/D	N/D
8.1Gi-C	DELCO	18-8838-1	N/D	N/D	N/D	N/D	18-7493	N/D	N/D	N/D
8.1GiC-400	DELCO	18-8838-1	N/D	N/D	N/D	N/D	18-7493	N/D	N/D	N/D
8.1GiCE	DELCO	18-8838-1	N/D	N/D	N/D	N/D	18-7493	N/D	N/D	N/D
8.1GiE	DELCO	18-8838-1	N/D	N/D	N/D	N/D	18-7493	N/D	N/D	N/D
8.1Gii-A	DELCO	18-8838-1	N/D	N/D	N/D	N/D	18-7648	N/D	N/D	N/D
8.1Gii-B	DELCO	18-8838-1	N/D	N/D	N/D	N/D	18-7648	N/D	N/D	N/D
8.1Gii	DELCO	18-8838-1	N/D	N/D	N/D	N/D	18-7493	N/D	N/D	N/D
8.1GSI-A	DELCO	18-8838-1	N/D	N/D	N/D	N/D	18-7648	N/D	N/D	N/D
8.1GXI	DELCO	18-8838-1	N/D	N/D	N/D	N/D	18-7493	N/D	N/D	N/D
8.1GXii	DELCO	18-8838-1	N/D	N/D	N/D	N/D	18-7493	N/D	N/D	N/D
8.1GXii-A	DELCO	18-8838-1	N/D	N/D	N/D	N/D	18-7648	N/D	N/D	N/D
8.1GXii-AF	DELCO	18-8838-1	N/D	N/D	N/D	N/D	18-7648	N/D	N/D	N/D
8.1GXii-A	DELCO	18-8838-1	N/D	N/D	N/D	N/D	18-7648	N/D	N/D	N/D
8.1IPS	DELCO	18-8838-1	N/D	N/D	N/D	N/D	18-7493	N/D	N/D	N/D
8.10Si	DELCO	18-8838-1	N/D	N/D	N/D	N/D	18-7493	N/D	N/D	N/D
8.2GL	PRESTOLITE	18-8803-1	18-5352	18-5403	-	N/D	18-5437	N/D	N/D	N/D
8.2GSI	DELCO EST	18-8836-1	18-5354	18-5405	18-5108	18-5107-1	18-5443	N/D	N/D	18-5281
DPX375	DELCO	18-8838-1	N/D	N/D	N/D	N/D	18-7648	N/D	N/D	N/D
DPX375-CF	DELCO	18-8838-1	N/D	N/D	N/D	N/D	18-7493	N/D	N/D	N/D
DPX385	DELCO EST	18-8836-1	18-5354	18-5405	18-5108	18-5107-1	18-5443	N/D	N/D	18-5281
DPX415	DELCO EST	18-8836-1	18-5354	18-5405	18-5108	18-5107-1	18-5443	N/D	N/D	18-5281
DPX420	DELCO	18-8838-1	N/D	N/D	N/D	N/D	18-7648	N/D	N/D	N/D
DPX420-CF	DELCO	18-8838-1	N/D	N/D	N/D	N/D	18-7493	N/D	N/D	N/D
V6-200	DELCO HVS	18-8829-1	18-5243	18-5245	18-7642	18-5117	18-5467	N/D	N/D	18-5246
V6-225	DELCO HVS	18-8829-1	18-5243	18-5245	18-7642	18-5117	18-5467	N/D	N/D	18-5246
V8-225	DELCO HVS	18-8828-1	18-5244	18-5245	18-7642	18-5117	18-5467	N/D	N/D	18-5247
V8-270	DELCO HVS	18-8828-1	18-5244	18-5245	18-7642	18-5117	18-5467	N/D	N/D	18-5247
V8-300	DELCO HVS	18-8828-1	18-5244	18-5245	18-7642	18-5117	18-5467	N/D	N/D	18-5247
V8-320	DELCO HVS	18-8828-1	18-5244	18-5245	18-7642	18-5117	18-5467	N/A	N/A	18-5247
V8-350	N/D	18-8838-1	N/D	N/D	N/D	N/D	-	N/D	N/D	N/D
V8-380	N/A	18-8838-1	N/A	N/A	N/A	N/A	-	N/A	N/A	N/A
V8-430	N/A	18-8838-1	N/A	N/A	N/A	N/A	-	N/A	N/A	N/A

Standard Rotation

CCW Rotation

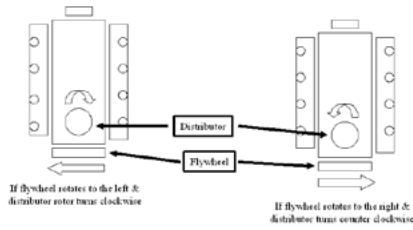

18-5920
MOTOR ARRANQUE
PMGR, Ford



18-5927
MOTOR ARRANQUE
PMGR, Ford



18-5911
MOTOR DE ARRANQUE
(Heavy-Duty) rotación como las agujas del reloj
Para motores GM, montaje inferior, tornillos paralelos y rotación standard.
Reemplaza: 834893, 855326
Reemplaza solenoide: 18-5837
SAEJ1171



18-5903
MOTOR ARRANQUE
Reemplaza: 841066-4
Rotación como las agujas del reloj
Montaje inferior, dos tornillos, motores FORD rotación standard.
Reemplaza solenoide: 18-5801

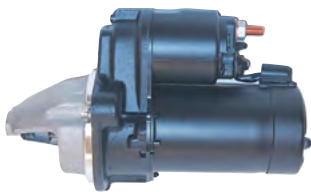

18-5906
MOTOR DE ARRANQUE MANUFACTURADO
Reemplaza: 840808, 872241
• Intraborda
• Arranque reducción de marcha
• Magnético permanente, 12 Volt
• Rotación standard
• Piñón alojamiento aluminio con 2 roscas en agujero de montaje
Para : Motores Volvo Penta 4 Cilindro y 6 Cilindro Gas



18-5913
MOTOR DE ARRANQUE
Reemplaza: 3856004, 3860764, 3587625, 3853982, 3854751, 3885317 (sentido reloj)
2 tornillos 12V - 11 dientes tornillos desplazados
Para: Último modelo GM 14" volante
Reemplaza solenoide: 18-6287
SAEJ1171
1.7 KW



18-5919
MOTOR ARRANQUE
Reemplaza: 3856003
Permanente magnético I/O arranque
Para: Motores Chevy con 12 3/4" volante tornillos paralelos
Reemplaza solenoide: 18-6287
SAEJ1171
Para: 3.0 GS
1.7 KW



18-5920
MOTOR ARRANQUE
Reemplaza: 3854190
Sentido agujas del reloj/Rotación standard
Arranque magnético permanente
Reemplaza solenoide: 18-6291
Para: Motores 5.0 & 5.8 litros Ford



18-6275
MOTOR ARRANQUE
Reemplaza: 3857747, 3860566
• Intraborda
• Reducción magnética permanente
• 2 tornillos largos
• Rotación sentido agujas del reloj
• Usar con último Modelo 3.0L motores con 14" volante
Reemplaza solenoide: 18-5811
Para : Volvo Penta, Mercruiser, Marine Power



18-6834
MOTOR ARRANQUE
Reemplaza: Motores GM Universal
Usar con todos motores GM con volante 14 1/4" o 12 3/4"



18-6835
MOTOR ARRANQUE
 Reemplaza: Motores GM Universal
 Usado en motores GM con volante de 14 1/4" o 12 3/4"



18-6839
MOTOR ARRANQUE
 Reemplaza: 1357199, -7, 3523301, -4, 5003564, -1
 Para: 240,740,760,780,940 series 2.3L



18-6872
MOTOR DE ARRANQUE
 (12 Volt)
 Reemplaza: 233991, 240501, 837924, 842775, 843511, 847306-8, 881681
 Para: 12V; Modelos TAMM, MD, AQD



18-6956
MOTOR DE ARRANQUE
 Reemplaza: 3803227, -2, 834625-6, 841378-3, 841380, 841762, 63, 65, 66,



18-6958
MOTOR DE ARRANQUE
 (24 Volt)
 Reemplaza: 847308-4, 870998, 881682
 Para: Modelos 24V; MD, TMD, TAMM



18-59710
ALTERNADOR
 Reemplaza: 820652, 822454, 827303, 847651, 849561, 849602
 Para: 24V; AQ Series gas y diesel
 24V sistema



18-5882
ALTERNADOR
 Reemplaza: 3884950
 75A, 12V, Serpentin
 3.0L, 4.3L, 5.0L, 5.7L, 8.1L (2007 - Actual)



18-5957
ALTERNADOR
 Reemplaza: 3860769
(3-cable) (68 AMP)
 Reemplaza Mando, Motorola y Original Equipamiento Delco.
 Usa mismas conexiones eléctricas y método de montaje.
 Equipado con ventilador y polea.
SAEJ1171



18-59700
ALTERNADOR
 Reemplaza: 3803227, -2, 834625-6, 841378-3, 841380, 841762, 63, 65, 66,



18-5979
ALTERNADOR
 Reemplaza: 3860082, Mando AC165622, Lester 12391
 65 amp, 3.0GSM-A/B/C, 3.0GSP-A/B/C, 3.0GLM-A/B, 3.0GLP-A/B, 4.3GX1-A/B/BF/C.CF.D.DF, 4.3OSI-B/BF/C/CF/D/DF, 5.0GX1-A



18-6261
ALTERNADOR
 Reemplaza: 3856600-6, 3857561
 Mando para último Modelo Volvo Penta, 12 Volt, 65 Amp, Regulador interno, Single Polea estrias



18-6265
ALTERNADOR
 Reemplaza : 3857813
 Para : Ultimos modelos Volvo Penta, 12 Volt, 65 Amp, Regulador interno , Polea simple.



PRONAUTIC
MARINE EQUIPMENT



18-5959
ALTERNADOR

Reemplaza: 826495, 834609, 834963, 841762, 841765, 841766.

Valeo A13N1M, 2M, 147M, 148M
14V/50 AMP: AQ120-AQ145, AQ200D-AD290-TMD40-MD21-8070-MD5C, MD18-7D-MD30-TMD30-TAM30, MD18-MD2B-MD2BHY-MD3B-MD21A, MD32A-AQD32A/270D (Mot V8S), MD5-MD7-MD11-MD17-B21-B22 Mot. TMD40), Series 2002-2003-R,V,S.



18-5939
ALTERNADOR

Reemplaza: 872235, 3803260, 873770
Valeo: A13N234, 2541451

14V/60 AMP: AQ115, AQ120B, AQ125, AQ130, AQ140, AQ145, AQ165, AQ170, AQ200, AQ225, AQ256, AQ260, AQ280, AQ290, BB115, BB145, MB20; Aplicación motor: AQD2B, AQD21A, AQD21B, AQD27, AQD29, AQD32A, MD11C, MD11D, MD17C, MD17D, MD2B, MD2010A, MD2010B, MD2030A, MD2030B, MD2040A, MD2040B, MD21A, MD21B, MD27, MD29, MD3B, MD32A, MD6A, MD6B, MD7, TAM71A, TAM71B, TAM72A, TAM72WI-A.



18-5943
ALTERNADOR

Reemplaza: 872926, 3803227

Valeo: A13N259, 541663

14V/50 AMP: 431, 500, 501, 570, 740DP, 740/MSS, AQ131, AQ145B, AQ175, AQ200, AQ205, AQ211, AQ225, AQ260, AQ271, AQ290, AQ311, BB165, BB170, BB225, BB231, BB260, BB261; Aplicación motor: 2001, 2002, 2003, 2003T, AD31A, AQAD30A, AQAD31A, AQAD40A, AQAD41, AQAD41A, AQD40A, AQD41, AQD41A, KAD42A, KAMD42A, MD30A, MS31A, MD40A, MD7B, TAMD40A, TAMD41A, TAMD41B, TAMD41D, TAMD70E, TMD30A, TMD31A, TMD40A, TMD41A.



18-6845
ALTERNADOR

Reemplaza: 3862613, 3862665, 3884950

Para: Motores 3.0GLM, 3.0GLP



18-6846
ALTERNADOR

Reemplaza: Volvo Penta 1502272, 3803270-2, 5001677, 845940, 72021, 872022, 872757, 873635, 873757, 873757-9, 873771,



18-6847
ALTERNADOR

Reemplaza: 3862613, 2655301,

Para: 2000-07 3.0GLP, GSP, GSM, 4.3GXi, 5.0GXi, Si, 5.7Gi, GXi, Osi, Sxi



18-5976
ALTERNADOR

Reemplaza: Motorola 9AR3743G, 510-821, 510-835, 510-836, 510-856, 510-861, 510-862

Para : Valeo 2937430 28V/45 AMP: TAMD 120, TMD 100, TMD 120



18-6975
ALTERNADOR (Universal)

Para: Alternador 160A, montaje universal basado en Delco CS1300, correa y serpentín de 6 estrías i polea incluida.



18-6848
ALTERNADOR

Reemplaza: Volvo 3862612, 2656299, Valeo A0002655299

Para: 2000 y on Volvo Penta Models con 4.3, 5.0, and 5.7 GM engines



18-6953
ALTERNADOR

Reemplaza: Volvo
Para: Modelos Diesel D3



18-6955
ALTERNADOR

Reemplaza: Caterpillar 3001117, 10-258, Prestolite 110-258, 110-258A, Volvo 849748-9

Para: Modelo cilindro Volvo Diesel 6

APLICACIÓN ALTERNADOR/ARRANQUE

MOTORES GASOLINA

Modelo	Motor	Año	Arranque	Alternador	Modelo	Motor	Año	Arranque	Alternador
AQ115			18-5918	N/D	AQ260A			18-5911	18-5959
AQ120B			18-5918 ①	N/D	AQ260B			18-5911	18-5959
AQ120B			18-5906	N/D	AQ271A			18-5911	N/D
AQ125A			18-5918 ①	18-5959	AQ271B			18-5911	N/D
AQ125A	4 cil	1981-1985	18-5906 ②	18-5959	AQ271C			18-5911	N/D
AQ125B	4 cil	1981-1985	18-5906 ②	18-5959	AQ271D			18-5911	N/D
AQ130			18-5918	N/D	AQ280			18-5911	N/D
AQ131A	4 cil	1985-1989	18-5906	18-5959	AQ290A			18-5911	18-5959
AQ131B	4 cil	1985-1989	18-5906	18-5959	AQ311A			18-5911	N/D
AQ131C	4 cil	1985-1989	18-5906	18-5959	AQ311B			18-5911	N/D
AQ131D	4 cil	1985-1989	18-5906	18-5959	BB115			18-5918	N/D
AQ140A			18-5918 ③	18-5959	BB140A			18-5918 ③	18-5959
AQ140A			18-5906 ②	18-5959	BB140A			18-5906	N/D
AQ145			18-5918	18-5959	BB145			18-5918	N/D
AQ145A	4 cil	1979-1985	18-5918 ③	18-5959	BB145A	4 cil	1979-1985	18-5918 ③	18-5959
AQ145A	4 cil	1979-1985	18-5906 ⑤	18-5959	BB145A			18-5906 ⑤	N/D
AQ145B	4 cil	1979-1985	18-5906 ⑤	18-5959	BB165			18-5918	N/D
AQ151A	4 cil	1985-1989	18-5906	18-5959	BB170			18-5918	N/D
AQ151B	4 cil	1985-1989	18-5906	18-5959	BB225A			18-5911	18-5959
AQ151C	4 cil	1985-1989	18-5906	18-5959	BB225B			18-5911	18-5959
AQ165			18-5918	N/D	BB225C			18-5911	18-5959
AQ170			18-5918	N/D	BB260A			18-5911	18-5959
AQ171A	4 cil	1986-1994	18-5906	18-5959 ⑥	BB260B			18-5911	18-5959
AQ171C	4 cil	1986-1994	18-5906	18-5959 ⑥	BB260C			18-5911	18-5959
AQ175A			18-5911 ⑤	N/D	230			18-5906	18-5943
AQ190A			18-5903	N/D	250			18-5906	18-5943 ⑦ 18-5939 ⑧
AQ200B			18-5911	18-5959	251A			18-5906	N/D
AQ200C			18-5911	18-5959	430			18-5911	18-5943 ⑦
AQ200D			18-5911	18-5959	431			18-5911	18-5943 ⑦
AQ200F			18-5911	18-5959	432			18-5911	18-5943 ⑦
AQ205A			18-5911	N/D	434			N/A	N/D ⑦ 18-5939 ⑧
AQ211A			18-5911	N/D	500-570			18-5911	18-5943 ⑦ 18-5939 ⑧
AQ225A			18-5911	18-5959	571A			18-5911	N/D N/D
AQ225B			18-5911	18-5959	572			18-5911	18-5943 18-5939 ⑧
AQ225C			18-5911	18-5959	740B			18-5911	18-5943 18-5939 ⑧
AQ225D			18-5911	18-5959	3.0L			18-5919	N/D
AQ225E			18-5911	18-5959	4.3L			18-5913	N/D
AQ225F			18-5911	18-5959	5.0L (GM)	V-8	1994-2007	18-5913	N/D
AQ231A			18-5911	N/D	5.7L (GM)	V-8	1994-2007	18-5913	N/D
AQ231B			18-5911	N/D	7.4L (GM)	V-8	1994-2007	18-5913	N/D
AQ240A			18-5903	N/D	8.2L (GM)	V-8	1994-2007	18-5913	N/D
AQ255A			18-5911	N/D	5.0L (FORD)	V-8	1994	18-5920	N/D
AQ255B			18-5911	N/D	5.8L (FORD)	V-8	1994	18-5920	N/D

① Inf SN 7679/013489

② AQ125A a partir de S/N 7679/013489

③ Inf SN 7705/001557

⑤ AQ145A & BB145A a partir de SN 7705/001557

⑥ 18-5959 14V/50AMP

⑦ Tornillos montaje en el soporte

⑧ 18-5939 14V 50 AMP



18-6291

SOLENOIDE

Reemplaza: 3854194-2, OMC 3854194
Para: Ford motor de arranque último
Último modelo 5.0L, 5.8L,
OMC y Volvo Penta



18-5806

SOLENOIDE ARRANQUE

Reemplaza: 834520
BOSCH 0331-302-050, 0331-302-081,
0331-302-085, 0331-302-581, 0331-302-585
Para motores con tapa de aluminio.
Terminal eje solenoide 13/32" de largo.



18-5811

SOLENOIDE ARRANQUE

Reemplaza: 3850216, 3859054
Para: Serie arranque PG 260, GM V6 & V8 (1983-Sup)



**18-5837
SOLENOIDE**

Reemplaza: 3853869, 3853998
Para: 3.0 ; GL, GS, 4.3L GL, GS, 5.7L GL, GI,
7.4L GL, 8.2L GL



**18-9802
LUZ PUESTA APUNTO**

Hasta de 10,000 RPM's



**18-69550
DISYUNTOR**

Reemplaza: 3854164
Para: Aplicaciones motores gasolina Volvo Multiple



**18-6271
RELÉ**

Reemplaza: 870670, 6643474, 876038,
241812
12 Volt, 30 Amp



**18-6268
RELÉ**

Reemplaza: 841177, 872272
12 Volt, 30 Amp



**18-6266
RELÉ**

Reemplaza: 876040, 872300
12 Volt, 30 Amp/20 Amp

① 18-5705D



**18-5705
RELÉ POWER TRIM**

Reemplaza: 876039
5 Terminal
Para: AQ 175, 200, 225D,
260, 290A



**18-5700
RELÉ TRIM**

Reemplaza:
3858081, 3858809
Para: (1998 SX-M-MAC, MDA, MLT), 3.0GLP-D,
4.3GL-E, 4.3GL-EF, 4.3GXl-F, 4.3GXl-FF, 4.3OSl-F,
4.3OSl-FF, 5.0GL-F, 5.0GL-FF, 5.0GXl-F, 5.0GXl-FF,
5.0Sl-F, 5.0Sl-FF, 5.7GIl-F/FF, 5.7GXl-G/GF, 5.7OSl-E/
EF, 5.7OXl-E/EF, 5.7GIl-F, 5.7GXl-G, 8.1GIl-F/GF,
8.1GXl-F/FF, 8.1OSl-C/CF, 8.1GIl-G, 8.1GXl-F, DPH-
A, DPH-B, DPR-A, DPH-B, EF drives, SX-M TSKs
1998-05, SX-M, DP-SM, (WT drives, PJX-C, PJX-S
SX-M, -MACLT, -MDA, -MDB, -MHP, -MTD, DP-E,
DP-S, -S1, -S2, DP-SM, -SM)XDP-B



**18-5704
RELÉ POWER TRIM**

Reemplaza: 876037
20 Amps Resis.
15 Amps Induct.
Tiro único 5 Terminal
Para: AQ270, 280

PACK. DE 5



**18-6951
18-6951-9②
FUSIBLE POWER TILT
(30 Amp)**

Reemplaza: 851120



**18-6770
BOMBA TILT/TRIM**

Reemplaza: 854346
Oildyne
Para: Transmisión Version SX con 2.5" tornillos cen-
trales y finas roscas
Motor 18-6817



**18-6806
BOMBA TRIM**

Reemplaza: 3587079, 3857489, 3860879
Para: SX - Último Modelo con rosca gruesa
Motor 18-6804



**18-6822
BOMBA TRIM**

Reemplaza: Volvo Penta 852928, 820545,
OMC 172543, 382715
Motor 18-6838



**18-6804
MOTOR TRIM**

Reemplaza: 3861575
Para: transmisiones SX - Última Versión / 2.3"
tornillos centrales con rosca gruesa



**18-6817
MOTOR TRIM**

Reemplaza: 854525-3, 3858071
Para: Último modelo Volvo Penta
Para: SX - primera Version / rosca fina & 2.5" tornillos
centrales

① Referencias acabadas en "D" envasadas - Referencia normal no envasada

② Precio por pack



18-6838
TRIM MOTOR
Reemplaza: 3586765, 852928, 872449, 873051
Para: transmisiones DP, DPX
Reemplaza Bomba 18-6822



18-6881
MOTOR CON BOMBA TRIM
Reemplaza: Volvo 852928, 872449, 873051,
Para: Transmisiones DP, DPX
Motor 18-6838
Bomba 18-6822



18-6823
CABLEADO
Reemplaza: Universal
Convierte 3-cables Tilt y Trim a 2-cables



18-6274
MOTOR TILT/TRIM
Reemplaza: 852928, 3857265
Reemplaza : Prestolite HYK4001
Incluye cuerpo válvula hidráulica



18-6758
MOTOR TILT/TRIM
Reemplaza: 850834
Electrolux KP5024/120



18-6779
MOTOR TRIM
Reemplaza: 986280, 3853945
Para: P,JX, SX, DPS, DP, DPX, 3.0L GS, GL, 4.3L GL, GS, GI, 5.0L FL, FI, 5.7L GL, GI, 5.8L FL, FI, FSI



18-6790
MOTOR TILT
Reemplaza: 839430,
Electrolux KS3448/290
Para: Modelos antiguos Volvo



18-6791
MOTOR TILT
Reemplaza: 850046, 853520
Para: Modelos antiguos Volvo



18-6792
MOTOR TILT
Reemplaza: 897720, 854329
Para: Modelos antiguos Volvo



18-7641
CARBURADOR
(Remanufacturado)
Reemplaza: 841047-4, 841313-0, 3856393
AQ225B,C,D,E,F; 225A,B; AQ260A,B; 290A; BB225A,AV, BB225B,C; 260A,AV,B,C; 501A, 501A/MS4A; 570/MS4A
Usar kit recambio 18-7095



18-79998
CARBURADOR
(Remanufacturado)
Reemplaza: R80316
Para: 3.0L GL, GS



18-80005
CARBURADOR
(Remanufacturado)
Reemplaza: 17059059
Para: AQ175, 200, 225, 290



18-80008
CARBURADOR
(Remanufacturado)
Reemplaza: R7044289
Para: 7.4L con 4 bbl Rochester



18-80009
CARBURADOR
(Remanufacturado)
Reemplaza: R80378
Para: 7.4L Gi, GL, Gsi & 8.2L GL



18-7000
KIT CARBURADOR
 Reemplaza: 841836-0, 841292
 SOLEX ESQUEMA INFERIOR
 (856471 + 856472 = 18-7000)

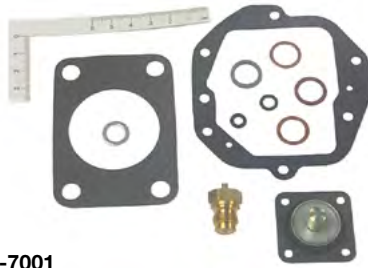

18-7001
KIT CARBURADOR
 Reemplaza: 841293-4
 SOLEX ESQUEMA LATERAL



18-7008
KIT CARBURADOR



18-7040
KIT CARBURADOR
 Contiene agujas y asientos



18-7072
KIT CARBURADOR
 Reemplaza: 855889



18-7085
KIT CARBURADOR
 Reemplaza: 875407



18-7086
KIT CARBURADOR
 Reemplaza: 841994

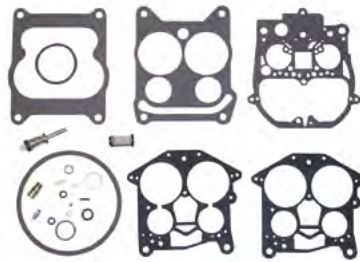

18-7095
KIT CARBURADOR
 Reemplaza: 834985-4



18-7237
KIT CARBURADOR



18-7238
KIT CARBURADOR
 Reemplaza: 3854020
 Para: 4.3L GL, GS, 5.0L GL, 5.7L GL



18-7241
KIT CARBURADOR
 Reemplaza: 3855017
 Para: 7.4L GL, 8.2L GL



18-7242
KIT CARBURADOR
 Reemplaza: 3854105

APLICACIONES EMPIEZAN EN LA SIGUIENTE PÁGINA

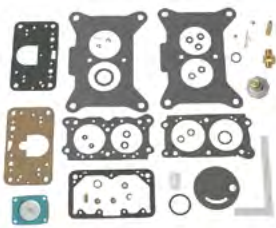

18-7244
KIT CARBURADOR
Reemplaza: 3854106



18-7245
KIT CARBURADOR
Reemplaza: 3854107



18-7246
KIT CARBURADOR
Reemplaza: 3854116
Para: 3.0L GLM, GLP, GSM, GSP, GS, GL



18-7099
KIT JUNTA CARBURADOR
Reemplaza: 824803, 856470



18-7200
FLOTADOR
Reemplaza: 841634-9
(RESISTENTE AL ALCOHOL)
Latón



18-7201
FLOTADOR
(RESISTENTE AL ALCOHOL)
Latón



18-7202
FLOTADOR
(RESISTENTE AL ALCOHOL)
Latón



18-36905
FLOTADOR
Reemplaza: 3854018
Para: 3.0L GLM, GLP con 2 bbl Holley Carb

KIT APLICACIÓN KIT CARBURADOR/FLOTADOR/JUNTA CARBURADOR

Modelo	Cil.	Mfg Cod	Carb Model	Carburador #	Kit Carb ①	Flotador	Kit junta carb
AQ115A,B,125A,B,130C,D, AQ131A,B,C,D,145A,B AQ151A,B,C,171A,C BB115B,C,145A	4	—	—	SOLEX 44 PA1	18-7000	—	18-7099
AQ120B,140A,BB140A	4	—	—	SOLEX 44 PHN-3	18-7001	—	—
AQ80	4	—	—	ZENITH 34VN	18-7008	—	—
AQ95,95A,100,105A,110, 115 W/109", (1780cc) Instalación Dual Carb.	4	ZS-1	150CD	150CD-SE (C1865F,R, C304D,F,R)	18-7085	—	—
AQ120, AQ130A,B,BB115A,w. 121" (1986cc) Instalación Dual Carb.	4	ZS-1	175CD	175CD-2S, (C3098F,R, C3200 F,R,C,3231 F,R)	18-7085	—	—
3.0L GL,GS	4	H-2	2300	R-80316A,R-80316-1A	18-7246	—	—
AQ170A,B,C,BB170A,B,C	6	—	—	SOLEX 44 PA1	18-7000	—	18-7099
AQ165A,BB165A (3 instalación Carb.)	6	ZS-1	175CD	175CD-2S, (C3201F,M, R,C 3232F,M,R)	18-7085	—	—
AQ175A	6	R-2	2GE	17059059	18-7086	18-7200	—
4.3L GL,GS	6	H-2	2300	R-80312A,R-80312-1A	18-7238	—	—
4.3L GL,GS	6	H-4	4160	R-80403A,R-80403-1A	18-7237	—	—
AQ200D,F and 500A	8	R-2	2GE	17057133, 17059059	18-7086	18-7200	—
AQ225B,C,D,E,F,255A,B, AQ260A,B,290A,BB225A,AV, BB225B,C,260A,AV,B,C	8	R-4	4ME	17059283,296, 298	18-7095	18-7201	—
501A,501A/MS4A,570/MS4A	8	R-4	4MC, 4MV	7044288,7044289, 1705,628717,057,290	18-7072	18-7201	—
305" (5.0L),307" (5.0L),350" (5.7),	8	R-4	4MC, 4MV	7044288,7044289, 1705,628717,057,290	18-7072	18-7201	—
5.0L, 5.8L (Fi, FL,SX) (Ford)	8	H-2	2300	R-80382A,R-80382-1A	18-7244	—	—
5.0L, 5.8L (Fi, FL) (Ford)	8	H-4	4150	R-80383A,R-80383-1A	18-7245	—	—
740A/MS5A	8	H-4	4011	R84026AA	18-7040	—	—
454" (7.4L)	8	R-4	4MC, 4MV	7044288,7044289, 1705,628717,057,290	18-7072	18-7201	—
7.4L GL	8	H-4	4150	R-80378A,R-80378-1A	18-7242	—	—
8.2L GL	8	H-4	4150	R-80378A,R-80378-1A	18-7242	—	—

① No incluye medidor

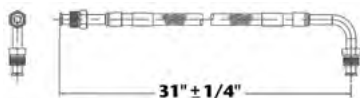

18-8114
LÍNEA DE COMBUSTIBLE
Conexión de la bomba de combustible al carburador.
Reemplaza tubo de 3/8" X 31" PTFE con terminales macho de 5/8"-18 y 5/8"-18 y 90°. SAE J1527 tipo A1

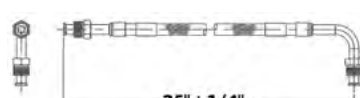

18-8115
LÍNEA DE COMBUSTIBLE
Conexión de la bomba de combustible al carburador.
Reemplaza tubo de 3/8" X 25" PTFE con terminales macho de 5/8"-18 y 5/8"-18 90° . SAE J1527 tipo A1



18-7326
BOMBA COMBUSTIBLE ELÉCTRICO
 Reemplaza: 3850809,
 3858261, 3854620, 3857986



18-7330
BOMBA COMBUSTIBLE ELÉCTRICO
 Reemplaza: 3857650, 3855958



18-7331
BOMBA COMBUSTIBLE ELÉCTRICO
 Reemplaza: 3850810,
 3857985, 3858714

APLICACIÓN BOMBA COMBUSTIBLE ELÉCTRICO

Año	Motor	Aplicación	OE #	#'s Ref.OEM antiguas	Ref #
1994-99	262/4.3L (HU-WT)	Bomba alta presión	3857650		18-7330
1994-99	262/4.3L GL/GS (All)	Carburador- Baja presión	3858261	3850809	18-7326
1994-99	262/4.3L GI (HU-WT)	W.Elec. bomba - Baja presión	3858261	3850809	18-7326
1994-99	454/7.4L & 502/8.2L (HU-WT)	Sistema baja presión	3858714	3850810, 3857985	18-7331
1993-99	350/5.7L, 454/7.4L, & 502/8.2L	Motores con MPI - Alta presión	3857650		18-7330
1996-99	454/7.4L & 502/8.2L (HU-WT)	Motores con MPI - Alta presión	3857650		18-7330
1994-99	5.0L hasta 5.8L	Bomba comb. eléctrica baja presión	3858261	3850809	18-7326
1994-99	454/7.4L & 502/8.2L (HU-WT)	Motores GM Mark V . - baja presión	3858714	3850810, 3857985	18-7331
1992-93	454/7.4L	Motores GM Mark V - baja presión	3858714	3850810, 3857985	18-7331



18-7268
BOMBA COMBUSTIBLE
 Reemplaza: 3855276
 Para: Motor 5.7L Litro
 Doble diafragma requiere la mirilla



18-7281
BOMBA COMBUSTIBLE
 Reemplaza: 826493
 Para: GM (V-8) 305, 350
 (Incluye junta)



18-7286
BOMBA COMBUSTIBLE
 Reemplaza: 841161
 Para: Bomba acero XP
 AQ120B (spec# 867465), AQ125A/B, AQ131A/B/C/D,
 AQ140A (spec# 867464), BB140A, AQ145A, BB145A,
 AQ151A/B/C, AQ171A/C, AQ230A/B, AQ250A/B, AQ251A



18-35442
BOMBA COMBUSTIBLE
 Reemplaza: 859428
 Para: Último motores Volvo 2000 Series



18-7229
ANTIDEFLAGRANTE
 Reemplaza: 3854026
 Para: 3.0L GS, GL, 4.3L GL, GS, GSI, 5.0L
 FL, FI, 5.7L GL, GI, 5.8L FL, FI, FSI



- DISEÑO UNIVERSAL -

SOPORTES SEPARADOR COMBUSTIBLE/AGUA



Tipo soporte	Ref #	Tipo soporte	Ref #
1/4" acero inox	18-7777	1/4" Aluminio	18-7853-1
3/8" acero inox	18-7776	3/8" Aluminio	18-7775

KIT SEPARADOR COMBUSTIBLE/AGUA



KITS DE FILTROS DE 21 MICRONES PARA MOTORES DE CARBURACIÓN

Kit Tipo	Ref #	Capacidad de filtrado	Contenido
1/4" Aluminio (Filtro corto)	18-7848-1 1878481E	21	1 - 18-7844 filtro & 1 18-7853-1 soporte 2 - 18-4256 1/4" Tapones
1/4" Aluminio Bonus Pack Contiene filtro de repuesto	18-7848-2	21	2 - 18-7844 filtro & 1 18-7853-1 soporte 2 - 18-4256 1/4" Tapones
1/4" Aluminio (Filtro alto)	18-7852-1	21	1 - 18-7845 filtro & 1 18-7853-1 soporte 2 - 18-4256 1/4" Tapones
1/4" Aluminio Bonus Pack Contiene filtro separador	18-7852-2	21	2 - 18-7845 filtro & 1 18-7853-1 Soporte 2 - 18-4256 1/4" Tapones
3/8" Aluminio (Filtro alto)	18-7775-1	21	1 - 18-7845 filtro & 1 18-7775 Soporte 2 - 18-4264 3/8" Tapones
1/4" Acero inox (Filtro alto)	18-7777-1	21	1 - 18-7845 filtro & 1 18-7777 Soporte 2 - 18-4256 1/4" Tapones
3/8" Acero inox (Filtro alto)	18-7776-1	21	1 - 18-7845 filtro & 1 18-7776 Soporte 2 - 18-4264 3/8" Tapones



KITS DE FILTROS DE 10 MICRONES PARA MOTORES DE INYECCIÓN

Kit tipo	Ref #	Capacidad de filtrado	Contenido
1/4" Aluminio (Filtro corto)	18-7983-1	10	1 - 18-7944 filtro & 1 18-7853-1 soporte 2 - 18-4256 1/4" Tapones
1/4" Aluminio Bonus Pack Contiene filtro separador	18-7983-2	10	2 - 18-7944 filtro & 1 18-7853-1 soporte 2 - 18-4256 1/4" Tapones
1/4" Aluminio (Filtro alto)	18-7982-1	10	1 - 18-7945 filtro & 1 18-7853-1 soporte 2 - 18-4256 1/4" Tapones
1/4" Aluminio Bonus Pack Contiene filtro separador	18-7982-2	10	2 - 18-7945 filtro & 1 18-7853-1 soporte 2 - 18-4256 1/4" Tapones
1/4" Aluminio (Filtro alta capacidad)	18-7966-1	10	1 - 18-7866 filtro & 1 18-7853-1 soporte 2 - 18-4256 1/4" Tapones
3/8" Aluminio (Filtro alto)	18-7986-1	10	1 - 18-7945 filtro & 1 18-7775 soporte 2 - 18-4264 3/8" Tapones
1/4" Acero inox (Filtro alto)	18-7984-1	10	1 - 18-7945 filtro & 1 18-7777 Soporte 2 - 18-4256 1/4" Tapones
3/8" Acero inox (Filtro alto)	18-7985-1	10	1 - 18-7945 filtro & 1 18-7776 Soporte 2 - 18-4264 3/8" Tapones



KITS FILTROS 10 MICRONES CON VASO DECANTADOR

El vaso transparente Sierra AquaVue™ y la cazoleta metálica permiten drenar el agua, alargan la vida útil del filtro.
Use el vaso transparente AquaVue™ para instalaciones de fueraborda y en la cubierta.

Kit Tipo	Ref #	Capacidad de filtrado	Contenido
1/4" Aluminio con cazoleta metálica	18-7951	10	1 - 18-7919 filtro & 1 18-7853-1 soporte 1 - 18-7924 cazoleta metálica 2 - 18-4256 1/4" tapones
1/4" Acero inox con cazoleta metálica	18-7938	10	1 - 18-7919 filtro & 1 18-7777 soporte 1 - 18-7924 cazoleta metálica 2 - 18-4256 1/4" tapones

KITS SOPORTES Y SEPARADORES TIPO VOLVO

18-7778
SOPORTE DE ALUMINIO
SOPORTE DE RECAMBIO
Reemplaza: 3850861



KIT SEPARADOR Y SOPORTE- PARA APLICACIONES EN FUERABORDAS Y AGUA DULCE

18-7774
SOPORTE ALUMINIO



18-7965-1
KIT SEPARADOR COMPACTO
10 MICRON
Contiene:
1 - 18-7774 soporte
1 - 18-7865 filtro



FILTRO DE RECAMBIO



DISEÑO UNIVERSAL

FILTROS DE RECAMBIO 10 MICRONES			FILTROS DE RECAMBIO 21 MICRONES		
Ref #	Descripción		Ref #	Descripción	
18-7944	corto - 3.875"		18-7844 / 187944E	corto - 3.875"	
18-7945 / 187945E	Largo - 4.35"			Largo - 4.35"	
18-7866	Alta capacidad - 6"		18-7845	Largo - 4.35"	
18-7865	Compacto 10 Micrones				
FILTROS DE RECAMBIO PARA VOLVO					
FILTRO RECAMBIO 10 MICRONES			FILTRO RECAMBIO 21 MICRONES		
Ref #	Descripción	Reemplaza	Ref #	Descripción	Reemplaza
18-7946	Rosca OMC		18-7846	Rosca OMC	
18-7989	Volvo SX/EFI Cobra EFI	Volvo 3851218-2, 3852413, 3862228	18-7789	Volvo SX/EFI Cobra EFI	Volvo 3851218-2, 3852413



RECAMBIOS DE FILTROS Y KITS CON CAZOLETA DE 10 MICRONES

FILTRO RECAMBIO			CAZOLETAS DE RECAMBIO	
Ref #	Descripción	Reemplaza	Ref #	Descripción
18-7919	Filtro	Racor S3213	18-7924	Cazoleta metálica
18-7920	Filtro	Racor S3214		
18-7947	Filtro Para - 120RRAC01	Racor S3240	FILTRO & CAZOLETA	
18-7948	Filtro Para - 320RRAC01	Racor S3227	Ref #	Descripción
18-7949	Filtro Para - 660RRAC02	Racor S3232	18-7929	Filtro & Cazoleta metálica Contiene: 18-7919 filtro, 18-7924 caz.

18-8125 FILTRO COMBUSTIBLE DIESEL

Reemplaza: 3583443

D4-180i-B, D4-180i-C, D4-210A-A, D4-210A-B, D4-210i-A, D4-210i-B, D4-225A-B, D4-225A-C, D4-225i-B, D4-225i-C, D4-260A-A, D4-260A-B, D4-260A-C, D4-260D-B, D4-260D-C, D4-260i-A, D4-260i-B, D4-260i-C, D4-300A-A, D4-300A-C, D4-300D-C, D4-300i-A, D4-300i-C, D6-280A-A, D6-280A-B, D6-280i-A, D6-280i-B, D6-310A-A, D6-310A-B, D6-310D-A, D6-310D-B, D6-310i-A, D6-310i-B, D6-330A-B, D6-330A-C, D6-330D-B, D6-330D-C, D6-330i-B, D6-330i-C, D6-350A-A, D6-350A-B, D6-370A-B, D6-370A-C, D6-370D-A, D6-370D-B, D6-370D-C, D6-370i-A, D6-370i-B, D6-370i-C, D6-435D-A, D6-435D-C, D6-435i-A, D6-435i-C



18-8126 FILTRO COMBUSTIBLE DIESEL

Reemplaza: 861477

D1-13 A, D1-13 B, D1-20 A, D1-20 B, D1-30 A, D1-30 B, D2-40 A, D2-40 B, D2-55 A, D2-55 B, D2-55 C, D2-55 D, D2-55 E, D2-55 F, D2-75 A, D2-75 B, D2-75 C, D2-75 F, MD2010A, MD2010B, MD2020A, MD2020B, MD2030A, MD2030B, MD2040A, MD2040B



18-7858 FILTRO COMBUSTIBLE

Reemplaza: 858201

Para tipo CAV

AQ120B, 125A, B, 131A, 140A, 145A, B, 151, BB, 140, 145A



18-7862 ELEMENTO FILTRANTE COMBUSTIBLE

Reemplaza: 841162

(Incluye junta)



18-8149 FILTRO SEPARADOR AGUA/COMB. DE ALTA CAPACIDAD

Reemplaza Volvo 3847644

Para mayoría de aplicaciones con bomba combelétrica. (pueden darse problemas de altura cuando se use la ref 18-7778, Volvo 3850861)



18-7942 FILTRO COMBUSTIBLE

Reemplaza:

466987, 3825133

Para: MD100A, TMD100A, MD100B, MD120A, TMD120A, TAMD120A, MD120B, TMD120B, TAMD120B, MD70B, TMD70B, TAMD70B, THAMD70B, AQAD70B, MD70C, TMD70C, TAMD70C, AQD70C, TAMD60A, TAMD60B, TAMD60C, D5/D7 MARINE GENSER, D5A-T, D5A-TA, D7A-T, D7A-TA, D7C-TA, D63 MARINE, D71/73 MARINE, KAD32P, TAMD42WJ, KAD43P/44P/300, KAMD43P/44P/300, TAMD103A, TAMD61A, TAMD62A, TAMD71A, TAMD72A, TAMD72P, TAMD72WJ, TAMD74, TAMD75 MARINE, TMD102A, TMD102A, TAMD102D, TMD122A, TAMD122A, TAMD122P, TMD31L, TAMD31P/L/M/S, AD31P/L, TMD41L, TAMD41P/L/M/H



18-7709 FILTRO COMBUSTIBLE

Reemplaza: 3840335

Para: KAD42P-A, KAMD42P-1, KAD44P-B, KAD44P-C, KAMD44P-A, KAMD44P-B, KAMD44P-C, TAMD42WJ-A, KAD43P-A, KAMD43P-A, KAT44P-C, KAD300-A, KAMD300-A, MD6A, MD6B, MD7A, MD7B, D41L-A, TAMD41H-B, TMD41L-A, AD41L-A, AD41P-A, TAMD41H-A, TAMD41P-A, MD22A, MD22A-A, MD22L-A, TMD22A, TMD22-A, D3-110i-A, D3-130A-A, D3-130i-A, D3-160A-A, D3-160i-A, D3-110i-B, D3-110i-C, D3-130A-B, D3-130i-B, D3-130A-C, D3-130i-C, D3-160A-B, D3-160i-B, D30160A-B, D3-160A-C, D3-160i-C, D3-190A-B, D3-190i-B, D3-190A-C, D3-190i-C, KKAD42A, KAMD42A, AD41D, D41D, TAMD41D, TMD41D, MD22L-B, MD22P-B, TMD22-B, TMD22P-C, TAMD22P-B



18-7859 FILTRO COMBUSTIBLE

Reemplaza: 835576

Para: AQ175, 200, 226, 266, 290 BB200, 225, 260



18-8124 FILTRO COMBUSTIBLE

Reemplaza: 829913

Para: 2001, 2001B, 2002, 2002B, 2003, 2003B/7TB, AQD2B, MD11C/D, MD17C/D, MD1B, MD2B, MD3B, MD5A/B/C, MD7/B



18-7792 FILTRO COMBUSTIBLE

Reemplaza: 3855104

Para: Volvo 3.0L (1994-99), OMC 3.0L (1995-98)





18-7964
KIT FILTRO TRANSMISIÓN
Para: Mercuriser V-8 Intraborda con transmisión hurth



18-7717
ELEMENTO FILTRANTE
Para: Carburadores Rochester 2 bbl & 4 bbl



18-79007
FILTRO DE AIRE
Reemplaza: 3825038
Fits: TAMD63L-1, TAMD63P-A



18-7689
COMBUSTIBLE INYECTOR
Reemplaza: 3855182
Para: 5.7GLPMDA, 5.7GIPMDACE, 5.7GLIMDA, 5.7GIIMDA, 4.3GLPHUB, 4.3GSPHUB, 4.3GSPHUS, 4.3GIPHUSCE, 5.7GIPHUS, 4.3GLPNCA, 4.3GLPNCB, 4.3GLPNCS, 4.3GSJNCC, 4.3GSJNCS, 4.3GSPNCA, 4.3GSPNCB, 4.3GSPNCM, 4.3GSPNCS, 4.3GIPNCACE, 4.3GIPNCBCE, 4.3, 5.7GLPNC, 5.7GIPNCACE, 5.7GIPNCSC, 5.7GIPNCMCE, 5.7GIPNCBCE, 5.7GIINCCCE, 5.7GIINCSCE, 4.3GLPLKD, 4.3GLPLKE, 4.3GSPLKD, 4.3GSPLKE, 4.3GIPLKDC, 4.3GIPLKECE, 4.3GSJLKD, 5.7GLPLKA, 5.7GLPLKE, 5.7GLPLKE, 5.7GLPLKR, 5.7GSPLKD, 5.7GSPLKE, 5.7GLIPLKDC, 5.7GIPLKDC, 5.7GIPLKECE, 5.7GSICPLKD, 5.7GSIPLK, 4.3GLPBYC, 4.3GSPBYC, 4.3GIPBYCE, 4.3GSJBYA, 4.3GIJBYA (1994-07)



18-7685
TBI INYECTOR
Reemplaza: 3858941
Para: 4.3GXi-A, 4.3GLPWTC, 4.3GLPWTR, 4.3GSP-WTC, 4.3GSPWTR, 4.3GIPWTC, 4.3GIPWTR, 4.3GI-JWTR, 4.3GSJWTR, 4.3GLPEFS, 4.3GIPEFS



18-7702
SENSOR DE TEMPERATURA
Reemplaza: 3854527
Para: 5.0L Gxi-A(2001-02), 5.7L Gil-A (2001), 5.7L Gi-A(2000-01), 5.7L GSIL-A (2000-01), 5.7L Gxi-A(00-01), 5.7L Xil-A (00-01), 5.7L Gxi-B(01-02), Many 7.4L (1994-00), mayoría 8.1L (2005-Actual)



18-7601
SENSOR DE TEMPERATURA AIRE
Reemplaza: 3854158
Para: 5.0 Fi/5.8 Fi (1994-96) & 5.0 FL/5.8 FL/5.8 FSi (1995-96)



18-7513
SENSOR DE TEMPERATURA
Reemplaza: 3862500



18-7647
TRANSMISOR DE TEMPERATURA
Reemplaza: 872066
Para: 4.3GL-A, 4.3GL-B, 4.3GL-C, 4.3GL-D, 5.7GL-A, 5.7GL-B, 5.7GL-C, 5.7GL-D, 5.7GL-E, 5.0GL-A, 5.0GL-B, 5.0GL-C, 5.0GL-D, 5.0GL-E, 3.0GLP-A, 3.0GLP-B, 3.0GLM-A, 3.0GLM-B, 3.0GSP-A, 3.0GSP-B, 3.0GSP-C, 3.0GSM-A, 3.0GSM-B, 3.0GSM-C, 3.0GLM-C, 3.0GLP-C, 3.0GLP-D, 4.3GL-E, 4.3GL-EF, 5.0GL-F, 5.0GL-FF, 3.0GLP-E, 4.3GL-G, 4.3GL-GF, 4.3GL-J, 4.3GL-JF, 5.0GL-H, 5.0GL-HF, 3.0GLP-J, 3.0GLP-N, 5.0GL-J, 5.0GL-JF (1998-2007)



18-5897
TRANSMISOR DE TEMPERATURA
Reemplaza: 3853787
Para: 5.0L FL, FI, 5.8L FL, FI, FSI



18-5894
INT.LUZ PRESIÓN ACEITE
Reemplaza: 3852215



18-7700
SENSOR POSICIÓN ACCELERADOR
Reemplaza: 3857487
Para: modelos 4.3, 5.0, 5.7, 8.1, 8.2L



18-5899
TRANSMISOR PRESIÓN ACEITE
Reemplaza: 3857532
Para: 230, 250, 3.0L GLM, GLP, GSM, GSP, 4.3L GL, GXI, OSI, 5.0L GL, GXI, OSI, 5.7L GL, GI, GXI, GIL, GXIL, OSI, OSXI, 8.1L GI, GXI, OSI, GIL



18-7704
IAC MOTOR
Reemplaza: 3855194
Modelo: modelos 4.3, 5.0, 5.7, 7.4L



18-7705
IAC MOTOR
Reemplaza: 3843751
Para: 4.3GXIE-M



18-7684
SENSOR DE PICADO
Reemplaza: 3850396
Para: modelos 4.3, 5.0, 5.7, 7.4L (1994-2007)



18-7677
SENSOR DE GOLPE
Reemplaza: 3850357
Para: modelos 4.3, 5.0, 5.7L (2002-07)



18-7703
SENSOR DE GOLPE
Reemplaza: 3854512
Para: 7.4, 8.2L (1999-2001)



18-7679
SENSOR DE GOLPE
Reemplaza: 3854905
Para: 4.3L (1994-2002), 5.0L Gxi-A (2001-02), 5.7L Gil-A(2001), 5.7Gi-A, 5.7GXi-A, 5.7GXi-B, 5.7Gil-A, 5.7GSil-A, 5.7GXii-A, 5.7GXii-B(2000-03), 5.7GLPNCs, 5.7GIPNACE, 5.7GIPNCSC, 5.7GIPNCMCE, 5.7GIPNCBCE, 5.7GIINCCCE, 5.7GIINCSCE(1995-96)



18-33800
PCV VÁLVULA
Reemplaza: 3856884
Para: 4.3L EFI



18-7888
REC.TAPÓN Y JUNTA DRENAJE
Reemplaza: 826648, 862293
Para CAV Filtro



18-3513
BOMBA CIRCULACION
Reemplaza : 22844837
Para: 5.3L Y 6.2L GM



18-3506
BOMBA DE CIRCULACIÓN
Reemplaza: 21124846



18-3575
BOMBA DE CIRCULACIÓN
Reemplaza: 3854017
Para: Motores 3.0L 4 cil.
Usar junta 18-0327 (incluida)
(Bi-Direccional)



18-3577-1
BOMBA AGUA CIRCULACIÓN
Reemplaza: 3855991, 856609
Para: GM Bloque pequeño V8
Usar junta 18-0903 (incluida)
(Bi-Direccional)



18-3593
BOMBA AGUA CIRCULACIÓN
Reemplaza: 3854017, 3858340
Para : 3.0L 4 cil. ,GM 4 cil. & en línea 6 cil. Usa junta 18-0327 (incluida)
(Bi-Direccional)



18-3584
BOMBA AGUA CIRCULACIÓN
Reemplaza: 3853796
Para Ford 5.0 y 5.8
Usar junta 18-0147 (incluida)
(Bi-Direccional)



18-3599-1
BOMBA AGUA CIRCUALCIÓN
Reemplaza: 3853850, 835390, 856364
Para motores GM V-6 & bloque pequeño V-8
Usar junta 18-0981 (incluida)



18-3586
BOMBA AGUA
Reemplaza: 841640
(Eje de leva montada)
Para: 431A, 500A/B, 501A, 570A, 571A, AQ180, AQ200, AQ200B/C/D/F, AQ250A, AQ211A, AQ225, AQ231A/B, AQ260, AQ255B, AQ260A, AQ271A/B/C/D/, AQ280A, AQ290A



18-0368
KIT JUNTAS DE BOMBA DE CIRCULACIÓN AGUA
Para: B21, B23, AQ120B, AQ125A, AQ140A, BB140A, AQ145A, BB145A



18-2779
MANGUITO DE ESCAPE
Reemplaza: 3852696
D.I. 4" x
Para: 4.3L GL, GS, Gi, GXI, OSI, 5.0L FI, GL, FL, GXI, OSI, 5.7L GL, Gi, GIL, OSI, GXI, OSXI, 5.8L FL, FI, FSI, 7.4L GL, Gi, 8.1L Gi, GXI, OSI, 8.2L GL



18-2780-1
MANGUITO
Reemplaza: 3852741, 3863450
D.I. 4" x
Para: 3.0L GL, GS, Gi, GLM, GLP, GSM, GSP, GS, 4.3L GL, GS, Gi, GXI, OSI, 5.0L FL, FI, GL, GXI, OSI, 5.7L GL, Gi, GXI, OSI, OSXI, GIL, GXIL, 5.8L FL, FI, FSI, 7.4L GL, Gi, GSI, 8.2L GSI



18-2781
MANGUITO ESCAPE
Reemplaza: 3852742
D.I. 4" x
For: 5.0L FL, GL, GXI, OSI, 5.7L GL, Gi, GXI, GIL, GXIL, OSI, OSXI, 5.8L FL, FSI, 7.4L GL, Gi, GSI, 8.1L, 8.2L GL, GSI



18-3106
ACOPLAMIENTO BOMBA AGUA
Reemplaza: 806256, 831009
AQ90, 95, 100, 110, 120A, 115, 130, MB3B, 17C, D

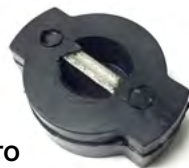

18-3175
ACOPLAMIENTO BOMBA AGUA
Reemplaza: 858467
Para: D31, D32, D41, D42, D43, D44, D300, AD31A, AD31B, AD31D, AD31L-A, AD31P-A, AD31XD, AQAD31A, MD31A, TAMD31A, TAMD31B, TAMD31D, TAMD31L-A, TAMD31M-A, TAMD31P-A, TMD31A, TMD31B, TMD31D, TMDL-A, KAD32P-A, AD41A, AD41B, AD41D, AD41L-A, AD41P-A, AQAD41A, D41A, D41B, D41D, D41L-A, TAMD41A, TAMD41B, TAMD41D, TAMD41H-A, TAMD41L-A, TAMD41M-A, TAMD41P-A, TMD41A, TMD41B, TMD41D, TMD41L-A, KAD42A, KAD42B, KAD42P-A, TAMD42B, TAMD42WJ-A, KAD43P-A, KAMD43P-A, KAD44P-A, KAD44P-B, KAD44P-C, KAMD44P-A, KAMD44P-B, KAMD44P-C, KAD300A, KAMD300A



18-31602
BOMBA AGUA MAR
Reemplaza: 3593654, 3580944
Para: MD, D1



18-31604
BOMBA AGUA MAR
Reemplaza: 3583115, 3581558
Para: KAD, KAMD, AD, TAMD



18-3274
CHAVETA IMPULSOR
 Reemplaza: 808007
 MD21B, AQD21B, 230A/SP-A/MT, 230A,
 230B, 250A, 250B, AQ125B, AQ145B,
 AQ131A, AQ151, AQ151A, AQ151B,
 AQ151C, AQ171, AQ171A, AQ171C, 251A



18-3275
KIT IMPULSOR
 Volvo 877066
 Para: TAMD74A, A-A, A-B (2000-2005); TAMD74C-A, C-B (2000-2005); TAMD74L-A, B (1999-2005); TAMD74P-A, P-B (1998-2005); TAMD75P-A (1998-2005); TAMD71B (1989-2000); TAMD73P-A (1997-1998); TAMD73WJ-A (1997-1999).



18-3504
KIT IMPULSOR
 Volvo 3588475
 Para: D4-180I-B, D4-180I-C, D4-180I-D, D4-210A-A, D4-210A-B, D4-210I-A, D4-210I-B, D4-225A-B, D4-225A-C, D4-225A-D, D4-225I-B, D4-225I-C, D4-225I-D, D4-260A-A, D4-260A-B, D4-260A-C, D4-260A-D, D4-260D-B, D4-260D-C, D4-260D-D, D4-260I-A, D4-260I-B, D4-260I-C, D4-260I-D, D4-300A-A, D4-300A-C, D4-300A-D, D4-300D-A, D4-300D-C, D4-300D-D, D4-300I-A, D4-300I-C, D4-300I-D



18-3276-1
KIT IMPULSOR
 Reemplaza: 3862567, 21213660
 Para: Volvo (1999 y posteriores)



18-3277
KIT IMPULSOR
 Reemplaza: 3862281, Yanmar
 192470-42530, 192470-42532
 Para: Volvo (1998 y anteriores),
 Johnson Pump 09-812B-1



18-3047
KIT IMPULSOR
 Reemplaza: 835874
 Sherwood 10615K,
 Jabsco 18948-0001
 12 PALAS



18-3060
IMPULSOR
 Reemplaza: 835512, 3854286
 Sherwood 9959,
 Jabsco 18838-0001
 Oberdorfer 132-0317
 OMC 3854286
 Neopreno, 12 PALAS

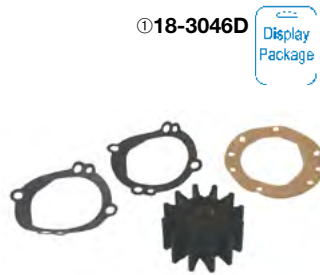

18-3046
IMPULSOR
 Reemplaza: 3854286



18-3061
IMPULSOR
 Reemplaza: 835874,
 Sherwood 0615K,
 Jabsco 18948-0001
 Neopreno
 12 PALAS
 Para: Motores con GM V-COREA



18-30778
IMPULSOR
 Reemplaza: 21213664
 Para: Motores Gas GM 2005 & Sup

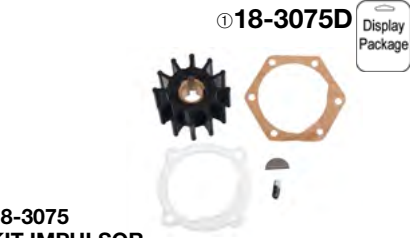

18-3075
KIT IMPULSOR
 Reemplaza: 875575, Jabsco 2877-0001,
 4568-0001, Johnson 09-801B,
 Oberdorfer B6620
 12 palas
 Neopreno



18-3076
KIT IMPULSOR
 Reemplaza: 875583, 833995
 Jabsco 22405-0001
 Bomba Johnson 09-45589,
 09-808B
 6 Palas, Neopreno



18-3077 (Neopreno) **18-3038** (Nitrilo)
KIT BOMBA AGUA
 Reemplaza: 877061-2, 3841697
 Para: AQ 30, 31, 40, 41 AQD 19, 27, 29, 32, KAD/KAMD
 42A, B, P, MD, 19, 27, 29, 32, TAMD 60A, B, C



18-3078 (Neopreno) **18-3037** (Nitrilo)
KIT BOMBA AGUA
 Reemplaza: 875736, 875660, 2430184
 Jabsco 836-0003,
 Johnson Pump 09-1029B-9
 Para: AQ, AD 40 A, B, TAMD 40 A, B, TAMD 61-62 A, 71-72A



18-3287
KIT IMPULSOR
 Reemplaza: 876120
 Para: 431A, BB231A, 570A, 571A, 572A, 740A, 740B,
 AQ200D, AQ205A, AQ225D, AQ255B, AQ260A, AQ260B,
 AQ271A, AQ271B, AQ271C, AQ271D, AQ280A, AQ290A,
 AQ311A, AQ311B, BB225A, BB225AV, BB225B,
 BB260A, BB260AV, BB261A



18-3079
KIT IMPULSOR
 Reemplaza: 875807-0, 3586498
 bomba Johnson 09-806B Sherwood
 9979K
 6 palas
 Neopreno
 Jabsco 4528-0001
 Anchura lateral 3/4" Dia. 1 9/16"

① Referencias acabadas en "D" envasadas - Referencias normales no envasadas



18-3080
(Neopreno)
KIT BOMBA AGUA
Volvo 875808, 3593659
Jabsco 673-0001
Bomba Johnson 09-1026B-1
Para: AQ 60, 80, 90, 95, 100, 105, 110, 115, 120A, 130, B 16, BB 25, 30, 70, 100, MB 18, 20, MD 3B, 17C, D, ND2010B, 2020B, 2030B, 2040BC

18-3036
(Nitrilo)
Jabsco 673-0003
Johnson Pump 09-1026B-9

① **18-3081D**



18-3081
KIT IMPULSOR
Reemplaza: 875811-2, 3858256, 3862281
OMC 3858256
Bomba Johnson 09-1027B
Neopreno
12 Estrias 12 Palas
Jabsco 1210-0001



18-3089
KIT BOMBA AGUA
Reemplaza: 09-45825
Bomba Johnson
Para bomba 18-3587



18-3205
KIT REPARACIÓN
Reemplaza: 875574
AQ120B, 125A, B, 131A, 140A, 145A, B, 151A, B



18-3208
KIT REPARACIÓN BOMBA AGUA
Reemplaza: 875584
MD5A, B, C, MD6B, MD7A, B, MD11C, D



18-3209
KIT REPARACIÓN BOMBA AGUA
Reemplaza: 875383
AQ165A, 170A, B, C, MD21A
(S/N MD103387 & SUP), MD21B



18-3261
KIT REPARACIÓN BOMBA AGUA
Reemplaza: 875769
Para: D40, AD40B, AQAD40A, AQAD40B, TAMD40A, TAMD40B

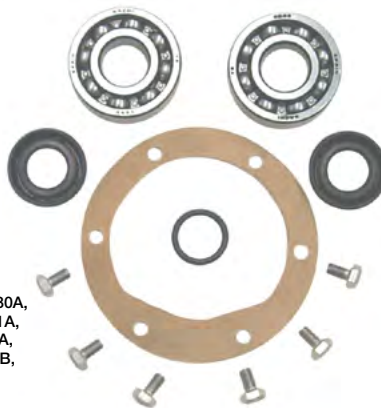

18-3262
KIT REPARACIÓN BOMBA AGUA
Reemplaza: 875759
Para bombas de agua salada: Para: D30, D31, D32, D40, D41, D42, D43, D44, AD30A, AQAD30A, TAMD30A, TMD30A, AD31A, AD31B, AD31D, AD31XD, AQAD31A, MD31A, TAMD31A, TAMD31B, TAMD31D, TMD31A, TMD31B, TMD31D, KAD32P-A, AQD40A, MD40A, TMD40A, TMD40B, TMD40C, AD41A, AD41B, AD41D, AQAD41A, D41A, D41B, D41D, TAMD41A, TAMD41B, TAMD41D, TMD41A, TMD41B, TMD41D, KAD42A, KAD42B, KAD42P-A, KAMD42A, KAMD42B, KAMD42P-A, TAMD42B, TAMD42WJ-A, KAD43P-A, KAMD43P-A, KAD44P-A, KAMD44P-A



18-3263
KIT REPARACIÓN BOMBA AGUA
Reemplaza: 875698
Para bombas agua salada: Para: B18, B20, D3, D17, AQ60F, AQ90, AQ95A, AQ110, AQ120, BB30, BB100, MB18, AQ105A, AQ115A, AQ115B, AQ130A, AQ130B, AQ130C, AQ130D, BB115, BB115B, BB115C, MB20A, MB20B, MB20C, MD3B, MD17C, MD17D,

DIÁMETRO MANGUITO ÚNICO

 <p>18-70021 MANGUITO 3/4" DI</p> <p style="font-size: 24px; margin-left: 100px;">4 3/4"</p>	 <p>18-70704 MANGUITO 1 1/4" DI</p> <p style="font-size: 24px; margin-left: 100px;">5"</p>	
 <p>18-70924 MANGUITO 1 3/4" DI</p> <p style="font-size: 24px; margin-left: 100px;">5"</p>	 <p>18-71218 MANGUITO 1" DI</p> <p style="font-size: 24px; margin-left: 100px;">12 1/2"</p>	 <p>18-71337 MANGUITO 1 3/4" DI</p> <p style="font-size: 24px; margin-left: 100px;">12 3/4"</p>

MANGUITO RECTO

 <p>18-75100 MANGUITO Recto 48" 1" DI</p>	 <p>18-75125 MANGUITO Recto 48" 1 1/4" DI</p>
------------------------------------------------------------------------------------------------------------------------------------------------------	------------------------------------------------------------------------------------------------------------------------------------------------------------

CORREAS



- 1** Cordón sintético de alta resistencia, Garantizan un comportamiento uniforme.
- 2** Compuesto especial de goma que asegura una suave transferencia de las fuerzas a la cuerda.
- 3** Dientes especialmente diseñados para mejorar la flexibilidad y mantener al mismo tiempo de resistencia. La forma geométrica de los dientes previenen de las rozaduras.
- 4** Los bordes de goma mantienen un contacto suave con las poleas de manera que la transferencia de energía sea efectiva.

TAMAÑO CORREA LISTADA POR REFERENCIA

Ref #	Longitud Efectiva (Pulg.)	Anchura (Pulg.)	Ref #	Longitud Efectiva (Pulg.)	Anchura (Pulg.)	Ref #	Longitud efectiva (Pulg.)	Anchura (Pulg.)
18-15290	29	29/64	18-15405	40 1/2	29/64	18-15460	46	29/64
18-15300	30	29/64	18-15410	41	29/64	18-15470	47	29/64
18-15325	32 1/2	29/64	18-15415	41 1/2	29/64	18-15480	48	29/64
18-15345	34 1/2	29/64	18-15430	43	29/64	18-15495	49 1/2	29/64
18-15370	37	29/64	18-15435	43 1/2	29/64	18-15500	50	29/64
18-15380	38	29/64	18-15440	44	29/64	18-15520	52	29/64
18-15390	39	29/64	18-15450	45	29/64	18-15550	55	29/64
18-15400	40	29/64	18-15455	45 1/2	29/64			

CRUCE DE REFERENCIAS DE LAS CORREAS

Ref #	Volvo #	Ref #	Volvo #	Volvo #	Ref#	Volvo #	Ref #
18-15325	958303	18-15460	829207	829207	18-15460	985357	18-15415
18-15390	958310	18-15460	950818	841821	18-15430	958498	18-4046
18-15405	958311	18-15495	958320	950813	18-15410	966694-2	18-4044
18-15410	950813	18-15500	952141	950818	18-15460	966857	18-4046
18-15415	985357	18-4046	958498	952141	18-15500		
18-4044	966694-2	18-4046	966857	958303	18-15325		
18-15430	841821			958310	18-15390		
18-15435	958314			958311	18-15405		
18-15435	966382			958314	18-15435		
18-15450	3858462			958320	18-15495		
18-15455	3852464			966382	18-15435		

CRUCE DE REFERENCIAS DE LOS MANGUITOS

Ref #	Volvo #	Ref #	Volvo #	Volvo #	Ref #	Volvo #	Ref #
18-70704	838513	18-75125	826423	826423	18-75125	845792	18-75125
18-70704	856306	18-75125	845792	838513	18-70704	856306	18-70704

**Fits GM Small Block V8 305-350 cu. in.
Models AQ & BB 200, 205, 211, 231, 225,
260, 271, 290, 311, 500, 501, 570, 571 & 572**

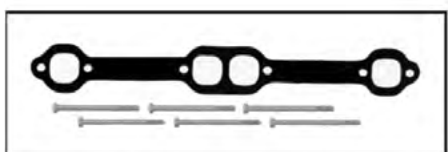

6/

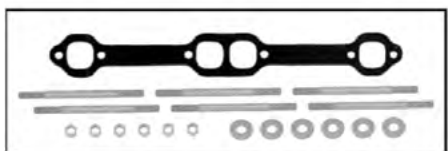

7/

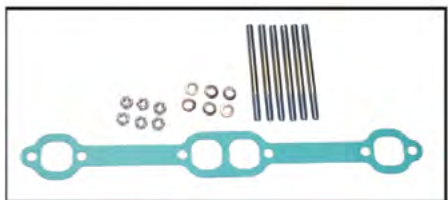

8/

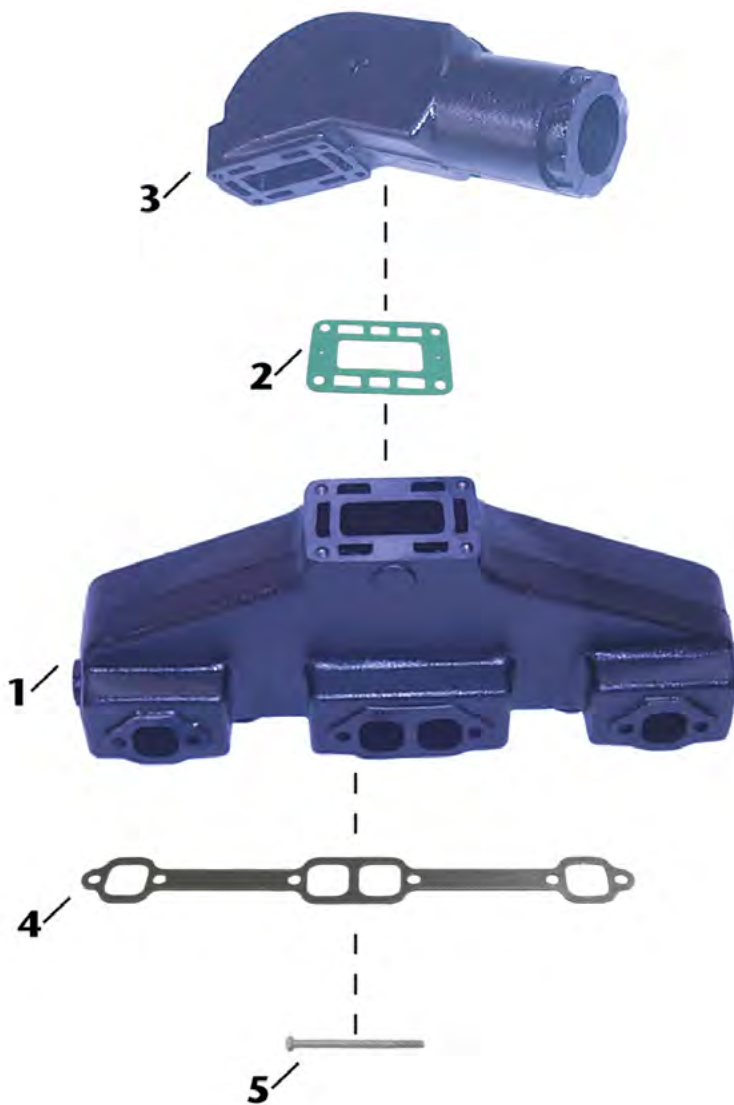

Ref	Descripción	OE No.	Aplicación
1	18-1931-1 COLECTOR ESCAPE 18-1931S	835804-6	GM Bloque pequeño (V8) 305-350 cu.in. Modelo AQ & BB 200, 205, 231, 225, 260, 271, 290, 311, 500, 501, 570, 571, & 572. Usar con Junta colector: 18-2949; Kit montaje: 18-8511.
2	18-2971-1 JUNTA CODO ESCAPE	856039-3	Usar con colector: 18-1931-1; Elbow: 18-1935-1
3	18-1935-1 CODO ESCAPE	855384-4	Usar con colector: 18-1931-1; Elbow Gasket: 18-2971-1.
4	18-2949 JUNTA COLECTOR ESCAPE	N/D	Usar con colector: 18-1931-1; kit de montaje 18-851.
5	NSI TORNILLO MONTAJE	N/D	Incluido en 18-8511 kit montaje.
6	18-8511 KIT MONTAJE	N/D	Usar con colector: 18-1931-1.
7	18-8502 KIT MONTAJE	N/D	Usar con colector: 18-1931-1. Incluye tornillos montaje.
8	18-8502 KIT MONTAJE	N/D	Usar con colector: 18-1931-1. Incluye tornillos montaje.

Fits GM V6 (1993 & Before) AQ 175, 205, 430A/B, 431, 434

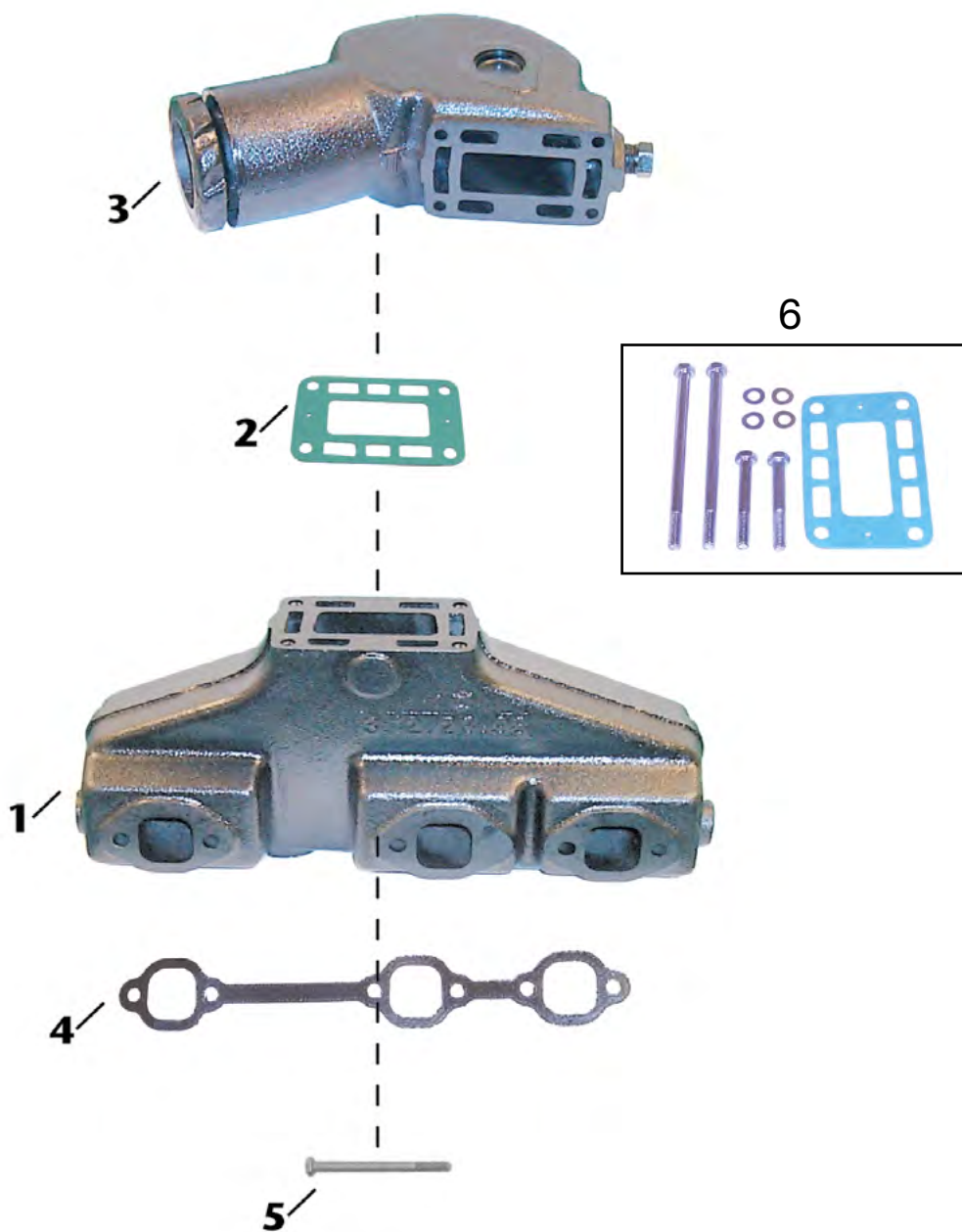

Ref	Descripción	OE No.	Aplicación
1 18-1932 18-1932S	COLECTOR DE ESCAPE	856894-1	GM (V6) (1993 & anterior) Modelo AQ 175, 205, 430 A/B, 432, 434. Usar con junta colector escape 18-2909.
2 18-2971-1	JUNTA CODO ESCAPE	856039-3	Usar con colector: 18-1932; codo: 18-1936.
3 18-1936	CODO ESCAPE	857037-6	Usar con colector: 18-1932; junta codo: 18-2971-1
4 18-2909	JUNTA COLECTOR	N/D	Usar con colector: 18-1932.
5 NSS	TORNILLO MONTAJE	N/D	Usar para fijar 18-2909 a 18-1932.
6 18-19360	KIT TORNILLO	N/D	Usar con codo 18-1936

COLECTORES DE ESCAPE

ESTÁN PINTADOS, EMPAQUETADOS Y A PRUEBA DE FUGAS



18-1848 HGE
18-1848S
COLECTOR
 Reemplaza: 3857656, 3847499
 Para: Volvo 4.3L V-6



18-1898
COLECTOR
 Babor & Estribor
 Reemplaza: Barr CHVA-1-84, Marine Power 0991-110
 Para 454 cu.in. GM bloque grande motores V8
 Usar con:
 Usar con: Junta colector escape: 18-0418



18-1930 HGE
18-1930S
COLECTOR DE ESCAPE
 Reemplaza: 855387, 834438-4
 Para: Volvo AQ120B, 125A, 140A, 145A, BB140A, 145A
 Suministrado con pack de montaje
 Usar con:
 Junta colector escape: 18-2991-1
 Kit montaje: 18-8539



18-1931 HGE
18-1931S
COLECTOR DE ESCAPE
 Babor & Estribor
 Reemplaza: 835804, 856883
 Para: Volvo AQ200D, 200F, 225D, 225E, 225F, 255B, 260A, 271A, 280A, 290A, 311A, AQ500, 570: BB225, 225AV, 225B, 260A, 260AV, 260B, 260C
 Suministrado con pack de montaje
 Usar con:
 Kit montaje: 18-8511



18-1986 HGE
18-1986S
COLECTOR DE ESCAPE
 Babor & Estribor
 Reemplaza: 3852374-2, 3857723, 3847501
 Para: 5.0L & 5.7L GM (Nuevo estilo)
 Usar con:
 Junta colector escape: 18-2949
 Kit montaje: 18-8502



18-1932 HGE
18-1932S
COLECTOR ESCAPE
 Babor & Estribor
 Reemplaza: 856894
 Para: 4.3L Para: AQ175, AQ430, AQ431A, AQ431B, AQ432, AQ434
 Usar con:
 Junta colector escape: 18-2909



18-1997S
COLECTOR
 Babor & Estribor
 Reemplaza: Barr CHV-1-83
 Colector para codo central
 Para: GM 283, 305, 307 and 350 CID engines
 Usar con:
 Juego juntas colector escape: 18-0604



18-1936 HGE
18-1936S
CODO ESCAPE
 Reemplaza: 857037
 Para: 4.3L Para: AQ175, AQ430, AQ431A, AQ431B, AQ432, AQ434
 Usar con:
 Junta codo escape: 18-2971-1
 Kit montaje: 18-19360



18-1999 HGE
18-1999S HGE
CODO

Reemplaza: Barr 20-0082
Viene con 18-4364 kit codo escape (abierto)
Para montaje cerrado use 18-8535
Reemplaza: Barr 20-0082-P
Usar con:
Colector: 18-1997-1
Junta codo: 18-2854-1 abierto o 18-0476-1 cerrado



18-1935 HGE
18-1935S HGE
CODO ESCAPE

Reemplaza: 855384-4, 856891
Usar con:
Colector: 18-1931-1
Junta codo escape: 18-2971-1
Kit montaje: 18-8510



18-1909 HGE
18-1909S HGE
CODO ESCAPE

Reemplaza: OMC 913784, 3855270, 3850456, Volvo 3855270-9, 3863061
OMC codo, 4" Salida 7°
Para mayoría GM & Ford colector codo centrado.
Usar con:
Colector: 18-1986-1 & 18-1848
Junta codo: 18-0943-2 abierto
Kit montaje: 18-8507 abierto



18-1939 HGE
CODO ESCAPE

Para usar con manguera escape 3 1/2" D.I.
Reemplaza: Barr 20-0100, Marine Power 0992-593 Barr, Indmar, y Marine Power Ford bloque pequeño V8 302-351cu.in., GM bloque pequeño V8 305-350cu.in., GM bloque grande V8 454cu.in. Usar con:
Colector: 18-1997-1, 18-1998-1
Junta codo escape: 18-2854-1 18-0476-1 cerrado
Kit montaje: 18-4364 abierto o 18-8535 cerrado



18-1907 HGE
18-1907S HGE
CODO ESCAPE

Para usar con manguera escape 3" D.I.
Reemplaza: Barr 20-0102, Indmar 53-2009, 53-2018 Barr y Indmar Ford bloque pequeño V8 302-351cu.in.
Usar con:
Colector: 18-1997-1, 18-1998-1
Junta codo escape: 18-2854-1 abierto o 18-0476-1 cerrado
Kit montaje: 18-4364 abierto o 18-8535 cerrado



18-1991
ADAPTADOR CODO ESCAPE

Para usar con manguera escape 3" D.I.
Usar con:
Prolongador de altura colector: 18-1999
30°



18-1992-1
ADAPTADOR CODO ESCAPE
Para manguera escape 3" D.I.
(Como utilizado en el kit de conversion 18-1987)
80°



P845261
CODO ESCAPE
Reemplaza: 845261

Para: D30, D40, AD30A, AQAD30, TAMD30A, TMD30A, AD40B, AQAD40A, AQAD40B, AQD40A, TAMD40A, TAMD40B, TMD40A, TMD40B, TMD40C

COLECTORES DE ESCAPE

ESTÁN PINTADOS, EMPAQUETADOS Y A PRUEBA DE FUGAS



18-1949
ESPACIADOR COLECTOR ESCAPE
 Barr, Indmar y Marine Power Ford bloque pequeño V8 302-351cu.in., GM bloque pequeño V8 305-350cu.in., GM bloque grande V8 454cu.in.
 Usar con:
 Colector: 18-1998-1, 18-1997-1, 18-1898



18-4364 (Abierto)
KIT CODO ESCAPE
 Reemplaza: Barr 20-0082-P
 Usar con:
 Codo escape: 18-1999, 18-1907, 18-1939



P859963
CODO VOLVO
 Volvo: 859963. Para TMD31, TMD41, TAMD31, TAMD41, AQAD31, AQAD41, AD31, AD41, MD31, MD41.



P851289
CODO VOLVO
 Volvo:861289, 860656 Para AD/KAD/KAMD 41/42P/44P/300



P3884701
CODO VOLVO
 Volvo:3884701, 384156. Para D-4 180/210/225/260/300



P21325765
ABRAZADERA ESCAPE
 Volvo 21325765



P825599
CODO VOLVO
 Volvo: 825599. Para motores Volvo antiguos 4L.AQ115A, AQ115B, BB115A, BB115B, BB115C, AQ130A, AQ130B, AQ130C, AQ130D.



P8245326
COLECTOR VOLVO
 Volvo: 8245326. Para motores Volvo antiguos 4L.AQ115A, AQ115B, BB115A, BB115B, BB115C, AQ130A, AQ130B, AQ130C, AQ130D.



18-8502
KIT MONTAJE COLECTOR ESCAPE
 OMC GM bloque pequeño V8 305-350cu. in. (1979-89) OMC/Volvo GM Bloque pequeño 305-350cu.in.
 Usar con:
 Colector: 18-1931-1,18-1902, 18-1903 & 18-1986-1



18-8507
KIT MONTAJE CODO ESCAPE
 OMC/Volvo GM Bloque pequeño V8 305-350 cu.in.
 Usar con:
 Codo escape: 18-1909-1

THE WIDEST VARIETY OF MARINE OILS, LUBES & FILTERS IN THE MARINE INDUSTRY.

OILS & LUBRICANTS

- All blends meet or exceed engine manufacturers' specifications. All Sierra Oils & Lubes "WILL NOT VOID" engine manufacturers' warranties.
- **FC-W** available in:
Premium 10W30, 25W40
Semi Synthetic 10W40, 25W40, 25W50
Full Synthetic 10W30
- **Other 4-Cycle Oils** available in:
Premium Diesel 15W40
Full Synthetic Gas/Diesel SAE30
- **Gear Lubes** available in:
Premium Blend
Hi-Performance Synthetic Blend
Synthetic
- **Premium Marine Bearing Grease**
Available in 15oz tubes

*Also available 16 & 55 gallon drums



FILTRATION

- **FUEL FILTERS/FUEL WATER SEPARATORS**
Sierra is an industry leader in 10-micron filter technology and offers an extensive line of 21-micron filters.
- **OIL FILTERS**
Sierra oil filter designs represent the very best of what we have learned after decades of research and development. No matter what type of boat you drive.



www.sierramarine.com



18-8510
KIT MONTAJE CODO ESCAPE
Volvo GM bloque pequeño V8 305-350 cu.in.
(Modelos: AQ y BB200, 205, 211, 231, 225, 260, 271, 290, 311, 500, 501, 570, 571, 572)
Usar con:
Codo escape: 18-1935-1



18-8511
KIT MONTAJE COLECTOR ESCAPE
Volvo GM bloque pequeño V8 305-350 cu.in. (Modelos: AQ y BB200, 205, 211, 231, 225, 260, 271, 290, 311, 500, 501, 570, 571, 572)
Usar con:
Colector 18-1931-1



18-8535 (Cerrado)
KIT MONTAJE CODO ESCAPE
Barr, Indmar y Marine Power Ford bloque pequeño V8 302-351cu.in., GM bloque grande V8 454cu.in.
Usar con:
Codo: 18-1939, 18-1999, y 18-1907



18-8536
KIT MONTAJE CODO ESCAPE
Barr, Indmar y Marine Power GM bloque pequeño V8 305-350cu.in.
Usar con:
Colector: 18-1997-1



18-8538
KIT MONTAJE COLECTOR ESCAPE
Barr y Indmar Ford bloque pequeño V8 302-351cu.in.
Usar con:
Colector: 18-1998-1

18-8539
KIT MONTAJE COLECTOR ESCAPE
Volvo 4 Cilindro B20 2.3 y 2.5L (Modelos: AQ 120, 125, 131, 140, 145, and 151. BB140, 145, 230, y 250) Volvo 4 Cilindro B20 2.3 y 2.5L (Modelos: AQ 120, 125, 131, 140, 145, y 151. BB140, 145, 230, y 250)
Usar con:
Colector: 18-1930-2



18-19360
KIT MONTAJE
Usar con:
Codo escape: 18-1936



18-0146
JUEGO DE JUNTAS
Para: B21, B23, AQ120B, AQ125A, AQ140A, BB140A, AQ125B, AQ145A, AQ145B, BB145A

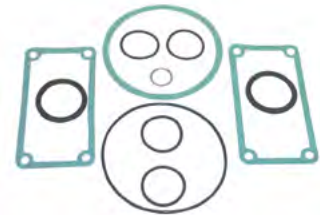

18-0337
JUEGO DE JUNTAS
Para: AD40B, AQAD40A, AQAD40B, TAMD40A, TAMD40B, TMD40B, TMD40C

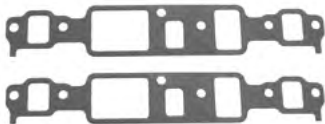

18-4408
JUEGO JUNTAS COLECTOR ADMISIÓN
Reemplaza: 3850379
Para: 4.3L GL, GS, GI



18-0476-1 (Cerrado)
JUNTA CODO ESCAPE
Reemplaza: Barr 01-0105
Indmar & Marine Power Ford bloque pequeño V8 302-351cu.in.
Usar con:
Junta codo escape: 18-1939, 18-1999 & 18-1907



Pack de 2
18-2854-1 (abierto)
18-2854-9①
JUNTA CODO ESCAPE
Reemplaza: Barr 01-0107
Usar con:
Colector: 18-1999, 18-1939, 18-1907

Pack. de 2



18-2875-1
18-2875-1-9①
JUNTA CODO ESCAPE
Reemplaza: 3850495
Para: 3.0L GS, GL, GLM, GLP, GSM, GSP

Pack. de 2



18-2902-1
18-2902-9①
JUNTA COLECTOR
Reemplaza: 3852468
Para: 5.0L GL, GXI, OSI, 5.7L GL, GI, GXI, GIL, GXIL, OSI, GXIL, OSXI



18-0418
JUNTA COLECTOR ESCAPE
Reemplaza: 3852472
Para : Volvo 7.4L GL, GI, GSI, 8.2GL, GI, GSI



18-0680
JUNTA COLECTOR ESCAPE
Reemplaza: 3853256

Pack. de 2



18-2949
18-2949-9^①
JUNTA COLECTOR ESCAPE
Reemplaza:
Barr CHV-47-000
Usar con:
Colector: 18-1986-1,
18-1997-1 and 18-1931-1
AQ200, 225, 260, 271, 290, 311



18-2971-1
JUNTA COLECTOR ESCAPE
Reemplaza: 835908-5, 856039-3
Usar con:
Codo escape: 18-1935-1

Pack. de 4



18-2991-1
18-2991-9^①
JUNTA COLECTOR ESCAPE
Reemplaza: 855967, 855383
Usar con:
Colector escape: 18-1930-2
AQ200, 225, 260, 271, 290, 311



18-4461
CONECTOR MANGUITO
3/4" - 14 NPT x 1" Manguera
Latón resistenten a la corrosión



TAPONES

Ref #	Diámetro rosca
18-4256	1/4"
18-4257	1/4"
18-4258	3/4"
18-4263	1/8" - 27 NPT
18-4264	3/8" - 18 NPT

TAPONES DRENAJE

Ref # Reemplaza:
18-4216 807036
18-4217 82744
18-4218 82745
18-4218D^②
18-4219 829592
18-4697
18-4699
18-3223-9^③
Pack de 12 (18-4218)
para mayoría de colectores originales OEM



APLICACIÓN TAPÓN DRENAJE			
Modelo	Tamaño rosca	Localización	Tapón
MD1A,B,2A,B,3B,5A,B,MD6A	10 x 1	Bloque cil	18-4216
AQ90,95,100,105,110,115,120,130,140A,145A,B, 151A,B,170,171A,MB18,20,BB30,100,MD19,21,32	1/8" NPT	Bloque cil	18-4217
AQ90,95,100,110,115,120,125A,B,130,131A,140A,145A,B, 151A,B,171A,MB18,MB20,BB30,100,AQD40,AQAD40,TMD40	1/4" NPT	Bloque cil	18-4218
MD5C,11C,D,17C,D	1/8" NPT	Bloque cil	18-4219
B18, B20, B21, B23, B25, B30, D31,	1/4" NPT	Refrig. aceite	18-4699
D40, 2001, 2002, 2003 V6, B23, B25, D30, D31, D40, D41	1/4" NPT	Refrig.aceite	18-4697

① Precio por pack
② Referencias acabadas en "D" envasadas - Referencia normal no envasada
③ Este producto es precio por pieza. Para pedir precio por pack, Añadir -9 a la referencia

Modelo	Colector Escape	Codo Escape	Kits montaje Colector	Kits codo escape	Junta Colector	Junta codo
230	18-1930-2	-	18-8539	-	18-2991-1	-
250	18-1930-2	-	18-8539	-	18-2991-1	-
AQ120B	18-1930-2	-	18-8539	-	18-2991-1	-
AQ125A	18-1930-2	-	18-8539	-	18-2991-1	-
AQ131A,B,C,D	18-1930-2	-	18-8539	-	18-2991-1	-
AQ140A	18-1930-2	-	18-8539	-	18-2991-1	-
AQ145A,B	18-1930-2	-	18-8539	-	18-2991-1	-
AQ151A,B,C	18-1930-2	-	18-8539	-	18-2991-1	-
AQ200C,D/280	18-1931-1	18-1935-1	18-8511 ^⑤ /18-8502 ^⑥	18-8510	18-2949	18-2971-1
AQ200D,F	18-1931-1	18-1935-1	18-8511 ^⑤ /18-8502 ^⑥	18-8510	18-2949	18-2971-1
AQ225C,D/280	18-1931-1	18-1935-1	18-8511 ^⑤ /18-8502 ^⑥	18-8510	18-2949	18-2971-1
AQ225D,E,F	18-1931-1	18-1935-1	18-8511 ^⑤ /18-8502 ^⑥	18-8510	18-2949	18-2971-1
AQ255A,B/280	18-1931-1	18-1935-1	18-8511 ^⑤ /18-8502 ^⑥	18-8510	18-2949	18-2971-1
AQ260A,B	18-1931-1	18-1935-1	18-8511 ^⑤ /18-8502 ^⑥	18-8510	18-2949	18-2971-1
AQ290A	18-1931-1	18-1935-1	18-8511 ^⑤ /18-8502 ^⑥	18-8510	18-2949	18-2971-1
AQ430	18-1932	18-1936	-	-	18-2909	18-2971-1
AQ431	18-1932	18-1936	-	-	18-2909	18-2971-1
AQ432	18-1932	18-1936	-	-	18-2909	18-2971-1
AQ434	18-1932	18-1936	-	-	18-2909	18-2971-1
BB140A	18-1930-2	-	18-8539	-	18-2991-1	-
BB145A	18-1930-2	-	18-8539	-	18-2991-1	-
BB225A,B,C	18-1931-1	18-1935-1	18-8511 ^⑤ /18-8502 ^⑥	18-8510	18-2949	18-2971-1
BB260A,B,C	18-1931-1	18-1935-1	18-8511 ^⑤ /18-8502 ^⑥	18-8510	18-2949	18-2971-1
500B	-	18-1936	-	-	18-2909	18-2971-1
501B	-	18-1936	-	-	18-2909	18-2971-1
570	18-1931-1	18-1935-1	-	-	18-2909	18-2971-1
572	-	18-1936	-	-	18-2909	18-2971-1
740B	-	18-1936	-	-	18-2909	18-2971-1
LK 4.3L	-	18-1936	-	-	18-2909	18-2971-1
LK 5.7L	18-1986-1	18-1909-1	18-8502	18-4364 ^⑦ /18-8535 ^⑧	18-2949	18-2854-1 ^⑦ /18-0476-1 ^⑧
HU 5.7 Gi	18-1986-1	18-1909-1	18-8502	18-4364 ^⑦ /18-8535 ^⑧	18-2949	18-2854-1 ^⑦ /18-0476-1 ^⑧
MD 5.7GL / 5.7Gi	18-1986-1	18-1909-1	18-8502	18-4364 ^⑦ /18-8535 ^⑧	18-2949	18-2854-1 ^⑦ /18-0476-1 ^⑧
NC5.7 GL / 5.7Gi	18-1986 -1	18-1909-1	18-8502	18-4364 ^⑦ /18-8535 ^⑧	18-2949	18-2854-1 ^⑦ /18-0476-1 ^⑧

⑤ Configuración Volvo Match (Tornillos en el Kit) ⑦ Junta abierta
⑥ Configuración OMC Match (Tuercas en el Kit) ⑧ Junta cerrada

Pack de 5



18-4236
18-4236-9①
ARANDELA
Reemplaza: 941907

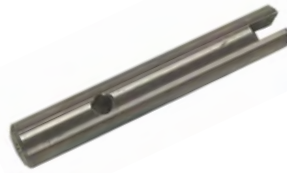

18-4150
EJE BOMBA AGUA
Reemplaza: 812994
Para bomba sin cojinete a bolas
AQ90, 95, 100, 105, 110, 115,
120, 130, MD3B, 17C



18-2774
MANGUITO
Reemplaza: 875847
AQ290, AQ290DP
Incluye (2) 18-7306 abrazaderas



18-2775
MANGUITO
Reemplaza: 875822
AQDRIVE UNITS 200, 250, 270, 270T,
275, 280, 280T, 280PT, DP UNIT: 280
Incluye (2) 18-7306 abrazaderas



18-2776
MANGUITO
Reemplaza: 832831
AQ270T, 280T
Incluye (2) 18-7306 abrazaderas



18-0163
JUEGO JUNTAS PIPETA REFRIGERACIÓN
Para: B30, AQ165A, AQ170A, AQ170B, AQ170C,
BB165A, BB170A, BB170B, BB170C



18-0376
JUEGO JUNTAS PIPETA REFRIGERACIÓN
Para: D6, D7, MD6A, MD6B, MD7A,
MD7B

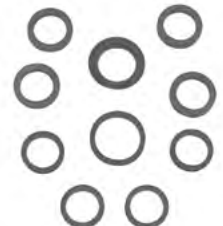

18-0377
JUEGO JUNTAS PIPETA REFRIGERACIÓN
Para: B21, B23, AQ120B, AQ125A,
AQ140A, BB140A, AQ125B, AQ145A,
AQ145B, BB145A



18-0590
JUEGO JUNTAS PIPETA REFRIGERACIÓN
Para: B20, AQ125A, AQ115B, AQ130A,
AQ130B, AQ130C, AQ130D, BB115A,
BB115B, BB115C



18-0648
JUEGO JUNTAS PIPETA REFRIGERACIÓN
Para: D11, D17, MD11C, MD11D,
MD17C, MD17D



18-3889
JUEGO JUNTAS PIPETA REFRIGERACIÓN
Para: B23, B25, 230A, 230B, AQ131A,
AQ131B, AQ131C, AQ131D, 250A,
250B, 251A, AQ151A, AQ151B, AQ151C,
AQ171A, AQ171C



18-0606
JUEGO JUNTAS PIPETA REFRIGERACIÓN
Para: B18, B20, AQ60F, AQ90, AQ95,
AQ95A, AQ110, AQ120, BB30, BB100,
MB18, AQ105A, MB20A, MB20B, MB20C



18-0907
JUEGO JUNTAS DRENAJE ACEITE
Para tapón aceite: Para: 200, 250, 270,
270T, 275, 275A

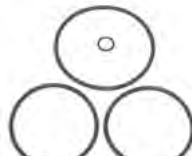

18-3890
JUEGO JUNTAS REFRIGERACIÓN
Para: B20, B21, B23, B25, B30, AQ115A,
AQ115B, AQ130A, AQ130B, AQ130C,
AQ130D, BB115A, BB115B, BB115C, MB20A,
MB20B, MB20C, AQ120B, AQ125A, AQ140A,
BB140A, 230A, 230B, AQ145A, AQ145B,
BB145A, 250A, 250B, 251A, AQ151A,
AQ151B, AQ151C, AQ171A, AQ17C, AQ165A,
AQ170A, AQ170B, AQ170C, BB165A,
BB170A, BB170B, BB170C



18-2777
JUEGO JUNTAS REFRIGERACIÓN
Reemplaza: 854031
*AQ120B, *AQ125A, B, AQ130A, B, D,
*AQ130C, *AQ131A, AQ140A, AQ145A,
*AQ165A, *AQ170A, B, C, *AQ175A,
AQ200D, AQ225D, *AQ225E, AQ260A,
AQ260B, AQ290A, *AQAD31A, AQD40A,
AQD21A, AQAD40A
* Modelos con Power Trim



18-2778
ALOJ. TERMOSTATO
Reemplaza: 832846
AQ140A, AQ145A, AQ165A, AQ170A,
*AQ175D, AQ200D, AQ225D, AQ260A,
AQ290A, *AQ280L, AQAD30A,
AQAD40A, B
* Modelos con Power Trim



18-3557
TERMOSTATO
Reemplaza: 21148403
143°



18-3558
TERMOSTATO
Reemplaza: 3853799
160°























18-3679
TERMOSTATO
Reemplaza:
3840816, 3584474
Para: D3



18-3680
TERMOSTATO
Reemplaza: 3580365
Para: MD, D2



18-3681
TERMOSTATO
Reemplaza: 8149182
Para: DH, TD, TAD, TWD,
D4, D6, TAMD

 <p>18-3539 KIT TERMOSTATO Sistema refrigeración cerrado (Incluye aro sellador) Reemplaza: 3831426 160°</p>	 <p>① 18-3676D Display Package</p>	 <p>① 18-3670D Display Package</p>	 <p>① 18-3677D Display Package</p>																																								
 <p>18-3538 KIT TERMOSTATO (Incluye aro sellador) Reemplaza: 3831424</p>	<p>18-3676 KIT TERMOSTATO Reemplaza: 3853983 140° — Contiene —</p> <table border="1"> <thead> <tr> <th>Ref #</th> <th>OE#</th> <th>Descripción</th> <th>Aro</th> </tr> </thead> <tbody> <tr> <td>18-7170</td> <td>3852071</td> <td></td> <td></td> </tr> <tr> <td>18-0398</td> <td>835417</td> <td></td> <td>Junta</td> </tr> <tr> <td>—</td> <td>3853983</td> <td></td> <td>Termostato</td> </tr> </tbody> </table>	Ref #	OE#	Descripción	Aro	18-7170	3852071			18-0398	835417		Junta	—	3853983		Termostato	<p>18-3670 KIT TERMOSTATO 160° — CONTIENE —</p> <table border="1"> <thead> <tr> <th>Ref #</th> <th>O.E.#</th> <th>Desc.</th> </tr> </thead> <tbody> <tr> <td>18-3558</td> <td>3853799</td> <td>Termostato</td> </tr> <tr> <td>18-2858</td> <td>3852127</td> <td>Junta tapa aloj. termostato</td> </tr> <tr> <td>18-0929</td> <td>3852120</td> <td>Junta termostato</td> </tr> </tbody> </table>	Ref #	O.E.#	Desc.	18-3558	3853799	Termostato	18-2858	3852127	Junta tapa aloj. termostato	18-0929	3852120	Junta termostato	<p>18-3677 KIT TERMOSTATO Reemplaza: 3856961 160° — Contiene —</p> <table border="1"> <thead> <tr> <th>Ref #</th> <th>OE#</th> <th>Descripción</th> </tr> </thead> <tbody> <tr> <td>18-7170</td> <td>3852071</td> <td>Aro tórico</td> </tr> <tr> <td>18-0398</td> <td>835417</td> <td>Junta</td> </tr> <tr> <td>—</td> <td>3856961</td> <td>Termostato</td> </tr> </tbody> </table>	Ref #	OE#	Descripción	18-7170	3852071	Aro tórico	18-0398	835417	Junta	—	3856961	Termostato
Ref #	OE#	Descripción	Aro																																								
18-7170	3852071																																										
18-0398	835417		Junta																																								
—	3853983		Termostato																																								
Ref #	O.E.#	Desc.																																									
18-3558	3853799	Termostato																																									
18-2858	3852127	Junta tapa aloj. termostato																																									
18-0929	3852120	Junta termostato																																									
Ref #	OE#	Descripción																																									
18-7170	3852071	Aro tórico																																									
18-0398	835417	Junta																																									
—	3856961	Termostato																																									
 <p>18-3656 KIT TERMOSTATO 140° Reemplazo: 876097, 875781</p>	 <p>18-3658 KIT TERMOSTATO 165° Reemplaza: 875784, 877349</p>	 <p>18-3654 KIT TERMOSTATO (60°C) Reemplaza: 875779 140°</p>	 <p>18-3659 KIT TERMOSTATO 160° Reemplaza: 875785</p>  <p>18-3660 KIT TERMOSTATO 170° Reemplaza: 875787, 3831425</p>																																								
 <p>18-3662 KIT TERMOSTATO 145° Reemplaza: 875794, 876305</p>	 <p>18-3663 KIT TERMOSTATO 130° Reemplaza: 875791</p>	 <p>18-3664 KIT TERMOSTATO 165° Reemplaza: 875795</p>	 <p>18-3665 KIT TERMOSTATO 140° Reemplaza: 875796</p>																																								
 <p>① 18-3666D Display Package</p> <p>18-3666 KIT TERMOSTATO (82°C) Reemplaza: 875580 180°</p>	 <p>18-3615 TERMOSTATO - AGUA Reemplaza: 3587597 150°</p>	 <p>18-3617 KIT TERMOSTATO</p>	 <p>18-3620 KIT TERMOSTATO 180°</p>																																								
 <p>18-3621 KIT TERMOSTATO 160°</p>	 <p>18-3626 KIT TERMOSTATO 145°</p>	 <p>18-3618 KIT TERMOSTATO REFR. AGUA 150°</p>	 <p>18-3619 KIT TERMOSTATO- REFR. AGUA DULCE 150°</p>																																								

APLICACIÓN TERMOSTATO EN LA SIGUIENTE PÁGINA

① Referencias acabadas en "D" envasados - referencia normal no envasada

SISTEMA DE REFRIGERACIÓN AGUA (ABIERTO)- EL AGUA (RIO, LAGO, MAR) CORRE A TRAVÉS DEL BLOQUE CILINDROS

Modelo	Version	Identificador	Año modelo	Termostato	Retén	Junta	Termostato y Kit retén	Kit Completo y junta de sellado
AQ90			1962-1964	NSS	18-2933		18-3656	
AQ95			1964-1968	NSS	18-2933		18-3656	
AQ100			1961-1963	NSS	18-2933		18-3656	
AQ130	A, B, C, D		1968-1977	NSS	18-2933		18-3656	
AQ115	A, B		1969-1975	NSS	18-2933		18-3656	
AQ140	A		1975-1979	NSS	18-2933	18-7181	18-3666	18-3620
AQ120	B		1977-1980	NSS	18-2933	18-7181	18-3666	18-3620
AQ145	A, B		1979-1985	NSS	18-2933	18-7181	18-3666	18-3620
AQ125	A, B		1981-1985	NSS	18-2933	18-7181	18-3666	18-3620
AQ131	A, B, C, D		1985-1989	NSS	18-2933	18-7181	18-3666	18-3620
230	A, B		1989-1993	NSS	18-2933	18-7181	18-3666	18-3620
AQ151	A, B, C		1985-1989	NSS	18-2933	18-7181	18-3666	18-3620
AQ171	A, C		1986-1989	NSS	18-2933	18-7181	18-3666	18-3620
250	A, B		1986-1993	NSS	18-2933	18-7181	18-3666	18-3620
251	A		1989-1992	NSS	18-2933	18-7181	18-3666	18-3620
3.0 GL, GS		MD,HU,NC	1993-1996	18-3558	18-0929	18-2858		18-3670
3.0 GL, GL, GSP, GLP, GLM		LK,BY,WT,EF	1996-2000	18-3558	NSS	18-0164		18-3621
3.0 GLP, GLM, GSP, GSM	A, B, C, D, E, J		2000-Actual	18-3558	NSS	18-0164		18-3621
3.0 GXi, 3.0GXIC	J		2009-Actual	18-3557	NSS	18-0164		18-3626
AQ175			1981-1985	18-3551	18-2933	18-0398		18-3662
AQ205	A		1988-1989	18-3551	18-2933	18-0398		18-3662
431	A, B		1989-1991	18-3551	18-2933	18-0398		18-3662
430	A, B		1990-1991	18-3551	18-2933	18-0398		18-3662
432	A		1992-1993	18-3551	18-2933	18-0398		18-3662
434	A		1992-1993	18-3551	18-2933	18-0398		18-3662
4.3 (Todos modelos)		MD,HU,NC,LK, BY,WT,EF	1993-2000	NSS	18-7170	18-2917		18-3677
4.3 (Todos modelos)	A, B		2001-2002	NSS	18-7170	18-2917		18-3677
4.3 (Todos modelos)	C, D, E, F, G, J		2002-Actual	NSS	NSS	18-2917	18-3615	18-3618
AQ190	A		1976-1977	18-3551		18-0398		18-3662
AQ200	B,C		1974-1976	18-3551		18-0398		18-3662
AQ225	B, C		1974-1976	18-3551		18-0398		18-3662
AQ200	D, F		1977-1986	18-3551		18-0398		18-3662
AQ225			1977-1986	18-3551	18-2933	18-0398		18-3662
AQ211	A		1986-1989	18-3551	18-2933	18-0398		18-3662
AQ231			1986-1989	18-3551	18-2933	18-0398		18-3662
500			1989-1993	18-3551	18-2933	18-0398		18-3662
501			1989-1993	18-3551	18-2933	18-0398		18-3662
5.0 FiP, FLP		MD,HU,NC	1993-1996	NSS	18-7170	18-2917		18-3677
5.0 GiP, GLP		BY,WT,EF	1997-2000	NSS	18-7170	18-2917		18-3677
5.0 GL, GXi, OSi	A, B		2001-2003	NSS	18-7170	18-2917		18-3677
5.0 (Todos modelos)	C, D, E, F, G, H, J, K		2002-Actual	NSS	NSS	18-2917	18-3615	18-3618
AQ271	A, B		1986	18-3551	18-2933	18-0398		18-3662
AQ260	A, B		1979-1985	18-3551	18-2933	18-0398		18-3662
AQ311	A		1986-1987	18-3551	18-2933	18-0398		18-3662
AQ271	C		1986-1989	18-3551	18-2933	18-0398		18-3662
AQ255	A, B		1977-1978			18-0398		
571	A		1989-1992	18-3551	18-2933	18-0398		18-3662
5.7 (Todos modelos)		MD, HU, NC, LK, BY, WT, EF	1993-2000	NSS	18-7170	18-2917		18-3677
5.7 (todos modelos excepto OSi) 18-3677		A, B, C		2001-2003	NSS	18-7170	18-2917	
5.7 OSi, OSXi	B, C		2001-2003	NSS	NSS	18-2917	18-3615	18-3618
5.7 (Todos modelos)	D, E, F, G, H, J, K		2002-Current	NSS	NSS	18-2917	18-3615	18-3618
5.8 (Todos modelos)		HU, NC	1993-1996	NSS	18-7170	18-2917		18-3677
740	A, B		1991-1993	18-3551	18-2933	18-0398		18-3662
7.4 (Todos modelos)		MD, HU, NC, LK, BY, WT, EF	1993-2000	NSS	18-7170	18-2917		18-3676
8.1 (Todos modelos)			2000-Actual	NSS	18-7170	NSS		18-3617
8.2 (Todos modelos)		MD, HU, NC, LK, BY, WT, EF	1993-2000	NSS	18-7170	18-2917		18-3676
SISTEMA DE REFRIGERACIÓN AGUA DULCE (CERRADO) - MOTOR EQUIPADO CON DEPÓSITO ANTI-CONGELACIÓN								
4.3, 5.0, 5.7 (Todos modelos)			1993 - Actual	NSS	18-2933	18-2917	18-3539	18-3619
5.8 (Todos modelos)			1993 - 1996	NSS	18-2933	18-2917	18-3539	18-3619
7.4 (Todos modelos)			1991 - 2000	NSS	18-2933	18-2917	18-3539	18-3619
8.1 (Todos modelos)			2000-Actual	NSS	18-2933	18-2917	18-3539	18-3619
8.2 (Todos modelos)			1993 - 2000	NSS	18-2933	18-2917	18-3539	18-3619



**18-1476
KIT ARBOL DE LEVAS**

Para: AQ165A, AQ170A, AQ170B, AQ170C, BB165A, BB170A, BB170B, BB170C



**18-1477
KIT ARBOL DE LEVAS**

Para: B18, B20, AQ60F, AQ90, AQ95, AQ110, AQ120, BB30, BB100, MB18, AQ105, AQ115A, AQ115B, AQ130A, AQ130B, AQ130C, AQ130D, BB115A, BB115B, BB115C, MB20A, MB20B, MB20C



**18-1478
ARBOL LEVAS**

Reemplaza: 1218674

Para: B18, B20, AQ60F, AQ90, AQ95, AQ95A, AQ110, AQ120, BB30, BB100, MB18, AQ105A, AQ115A, AQ115B, AQ130A, AQ130B, AQ130C, AQ130D, BB115A, BB115B, BB115C, MB20A, MB20B, MB20C



**18-1479
ARBOL DE LEVAS**

Reemplaza: 461511

Para: B30, AQ165A, AQ170A, AQ170B, AQ170C, BB165A, BB170A, BB170B, BB170C



VÁLVULA

Ref #	Tipo	O.E. #	Aplicación
18-4464	Escape	829620	D1, D2, D3, 3AA, D17, AQD2B, MD1B, MD2B, MD3B, MD11C, MD11D, MD17C, MD17D
18-4469	Escape	1542389	D40, AD40B, AQAD40A, AQAD40B, AQD40A, MD40A, TAMD40A, TAMD40B, TMD40A, TMD40B, TMD40C
18-4470	Escape	419735	B20, B30, AQ105A, AQ115A, AQ115B, AQ130A, AQ130B, AQ130C, AQ130D, BB115A, BB115B, BB115C, MB20A, MB20B, MB20C
18-4471	Escape	838638	D31, D32, D41, D42, D43, AD31L-A, AD31P-A, TAMD31L-A, TAMD31M-A, TAMD31P-A, TMD31L-A, KAD32PA, AD41L-A, AD41P-A, D41L-A, TAMD41H-A, TAMDS41L-A, TAMD41P-A, TMD41A, TMD41L-A, KAD42A, KAD42P-A, KAMD42A, KAMD42B, KAMD42P-A, TAMD42B, TAMD42WJ-A, KAD43P-A, KAMD43P-A
18-4463	Admis.	833188	D1, D2, D3, 3AA, D17, AQD2B, MD1B, MD2B, MD3B, MD11C, MD11D, MD17C, MD17D
18-4466	Admis.	838637	D31, D32, D41, D42, D43, AD31L-A, AD31P-A, TAMD31L-A, TAMD31M-A, TAMD31P-A, TMD31L-A, KAD32PA, AD41L-A, AD41P-A, D41L-A, TAMD41H-A, TAMDS41L-A, TAMD41P-A, TMD41A, TMD41L-A, KAD42A, KAD42P-A, KAMD42A, KAMD42B, KAMD42P-A, TAMD42B, TAMD42WJ-A, KAD43P-A, KAMD43P-A
18-4467	Admis.	1542472	D40, AD40B, AQAD40A, AQAD40B, AQD40A, MD40A, TAMD40A, TAMD40B, TMD40A, TMD40B, TMD40C
18-4468	Admis.	419734	B20, B30, AQ105A, AQ115A, AQ115B, AQ130A, AQ130B, AQ130C, AQ130D, BB115A, BB115B, BB115C, MB20A, MB20B, MB20C



**18-4465
VÁLVULA GUÍA**

Reemplaza: 3582609

Para escape, 230, 250, AQ115, BB115, MB20, AQ130, AQ165, BB165, AQ170, BB170, AQD21A, MD21A, AQ120B, AQ125A, AQ140A, BB140A, AQ125B, AQ131A, AQ131B, AQ131C, AQ131D, AQ145A, BB145A, AQ145B, AQ151A, AQ151B, AQ151C, MB10



**18-4472
ELEV. VÁLVULA**

Reemplaza: 1218630

Para: B18, B20, B30, AQ120, AQ90, AQ95, AQ110, AQ120, BB30, BB100, MB18, AQ105A, AQ115A, AQ115B, AQ130A, AQ130B, AQ130C, AQ130D, BB115A, BB115B, BB115C, MB20A, MB20B, MB20C, AQ165A, AQ170A, AQ170C, BB165A, BB170A, BB170B, BB170C



**18-4473
VÁLVULA GUÍA**

Reemplaza: 419653, 3582561

Para: AQ115, BB115, MB20, AQ130, AQ165, AQ170, BB170, AQD21A, MD21A, KAMD42A, KAD42A, KAMD42P, KAD42P, MD11, MD17, MD1B, MD2B, MD3B, MD30, TMD30, TAMD30, AQAD30, MD31A, TMD31B, TAMD40, AQAD40, TAMD42B, KAMD42B, KAD42B, TMD31D, TAMD31D, AD31XD, TMD41B, TAMD41B, D41B, TMD41D, TAMD41D, D41D, AD41D



**18-4474
VÁLVULA GUÍA**

Reemplaza: 419652, 3582606

Para admisión: Para: 230, 250, AQ115, BB115, MB20, AQ130, AQ165, BB165, AQ170, BB170, AQD21A, MD21A, AQ120B, AQ125A, AQ140A, BB140A, AQ125B, AQ131A, AQ131B, AQ131C, AQ131D, AQ145A, BB145A, AQ145B, AQ151A, AQ151B, AQ151C, MB10



**18-4029
CORREA DISTRIBUCIÓN**

Reemplaza: 463377

AQ120B, 125A, B, 131A, B, C, D 140, 145, 151A, B, C, 230, 250, BB140A, 145A, B 4 Cil.

18-4030
Reemplaza: 31359568, 31258305



**18-4044
CORREA**

Reemplaza: 834548, 966694-2

Generador: AQ120B, 125A, 140A, 145A, 165, 170A, B, C

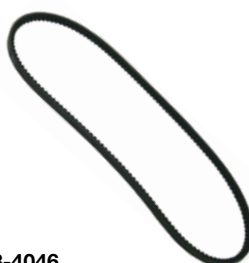

**18-4046
CORREA**

Reemplaza: 958498, 966857

Generador: AQ175A, 200A, B, C, D, 225A, B, 260A, B, 280A, 290A
Bomba agua AQ210 V-6, V-8



**18-8964
POLEA BOMBA DIRECCIÓN**

Reemplaza: 3853804

Para: Mayoría aplicaciones Volvo stern-drive

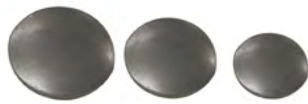

TAPONES EXPANSIÓN

Ref #	Env	O.E. #	Medida
18-4200 ① ②	5	477024	35MM (1.375")
18-4201 ① ②	5	192212	45MM (1.770")
18-4245 ②	5	463902	42MM (1.655")
18-4246 ②	5	463903-5	35MM (1.375")
18-4247 ②	5	463904	45MM (1.770")

① Acero inox.
② Este precio es precio por pieza. Para pedir envasado añadir 9 a la referencia.



18-2367
TUERCA CABEZA CILINDRO
Reemplaza: 943414
Para cabeza cilindro: Para: D1, D2, D3, D11, D17, MD1B, AQD2B, MD2B, MD11C, MD11D, MD3B, MD17C, MD17D



18-2793
KIT RETENES
Reemplaza: 875550
Para cilindros en línea: Para: D11, D17, MD11C, MD11D, MD17C, MD17D:
NOTA: Modelo MD11 requiere dos 18-2793 y Modelo MD17 requiere tres 18-2793



18-1727
SILENTBLOCK
Reemplaza: 803762
Acoplador de eje propulsor:
Para: B18, B20, B30, MB10, 2001, 2002, 2003, 2010, 2020, 2030, 2040, D1, D2, D3, D5, D6, D7, D11, D17, D21, D22, D29, D32, BB30, BB100, BB115, BB165, BB170, MB10A, MB18, MB20, MD1, MD2, MD3, MD5, MD6, MD7, MD11, MD17, MD21, MD22, MD29, MD32



18-4005
SILENTBLOCK
Reemplaza: 833950
Para: D5, D6, D7, D11, D17, MB10, MB10A, MD5A, MD5B, MD5C, MD6A, MD6B, MD7A, MD7B, MD11C, MD11D, MD17C, MD17D



18-57702
FILTRO
Reemplaza: 876069
Para: Volvo MD30A, TMD30A, TAMD30A, MD31A, TMD31A, TAMD31A, MD40A, TMD40A, TMD40B, TAMD40A, TAMD40B, TMD41A, TAMD41A



18-7907
FILTRO AIRE
Reemplaza: 858488
Para: D31, D41, D42, AD31A, AD31B, AD31D, AD31L-A, AD31P-A, AD31XD, AQAD31A, MD31A, TAMD31A, TAMD31B, TAMD31D, TAMD31L-A, TAMD31M-A, TAMD31P-A, TMD31A, TMD31B, TMD31D, TMD31L-A, AD41A, AD41B, AD41D, AD41L-A, AD41P-A, AQAD41A, D41A, D41B, D41D, D41L-A, TAMD41A, TAMD41B, TAMD41D, TAMD41H-A, TAMD41L-A, TAMD41M-A, TAMD41P-A, TMD41A, TMD41B, TMD41D, TMD41L-A, TAMD42B, TAMD42WJ-A



18-7908
FILTRO AIRE
Reemplaza: 3582358
Para: D31, D41, AD31A, AD31B, AD31D, AD31L-A, AD31P-A, AD31XD, AQAD31A, TAMD31A, TAMD31B, TAMD31D, TAMD31L-A, TAMD31M-A, TAMD31P-A, TMD31A, TMD31B, TMD31D, TMD31L-A, AD41D, AD41L-A, AD41P-A, AQAD41A, AQD41A, D41A, D41B, D41D, D41L-A, TAMD41A, TAMD41B, TAMD41D, TAMD41H-A, TAMD41L-A, TAMD41M-A, TAMD41P-A, TMD41A, TMD41B, TMD41D, TMD41L-A

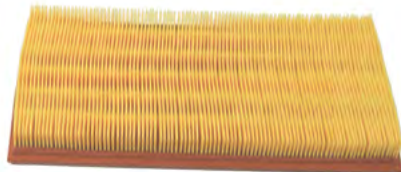

18-7890
FILTRO AIRE
Reemplaza:
463505, 876185
MD30, MD40, KAD42A, KAMD42A
Diesel



18-7514
BOMBA DIRECCIÓN
Reemplaza: 2279780
Para: SN-2004033423 DA-180I-B, D4-210A-A, D4-210A-B, D4-210I-A, D4-210I-B, D4-225I-B, D4-260A-AD4-260A-B, D4-260I-A, D4-260I-B, D4-300A-A, D4-300I-A



18-0035
FILTRO ACEITE DIESEL, FLUJO COMPLETO
Reemplaza: 3582732
Para: D4-180I-B, D4-180I-C, D4-210A-A, D4-210A-B, D4-210I-A, D4-210I-B, D4-225A-B, D4-225A-C, D4-225I-B, D4-225I-C, D4-260A-A, D4-260A-B, D4-260A-C, D4-260D-B, D4-260D-C, D4-260I-A, D4-260I-B, D4-260I-C, D4-300A-A, D4-300A-B, D4-300D-A, D4-300D-C, D4-300I-A, D4-300I-B, D4-300I-C, D6-280A-A, D6-280A-B, D6-280I-A, D6-280I-B, D6-310A-A, D6-310A-B, D6-310D-A, D6-310D-B, D6-310I-A, D6-310I-B, D6-330A-B, D6-330A-C, D6-330D-B, D6-330D-C, D6-330I-B, D6-330I-C, D6-350A-A, D6-350A-B, D6-370A-B, D6-370A-C, D6-370D-A, D6-370D-B, D6-370D-C, D6-370I-A, D6-370I-B, D6-370I-C, D6-435D-A, D6-435D-C, D6-435I-A, D6-435I-C



FILTROS ACEITE

FILTROS ACEITE

Ref #	O.E. #	Aplicación
18-8003	8692305	-
18-7824-1	835440	Filtro corto GM
18-7876	3850559	Filtro largo GM
18-7878-1	430143, 1266286, 3517857	Filtro corto Ford
18-7879-1	841750	V-6 GM

FILTRO ACEITE DIESEL

18-0032	847741	-
18-0033	478436	-
18-0034	477556	-
18-7880	466634	TAMD100, TMD102, TMD121, TMD122, TAMD122 & TAMD162
18-7884	834337	-
18-7974	3827069	-



18-0036
FILTRO ACEITE DIESEL
Reemplaza: 3582733
Para: D4-180I-B, D4-180I-C, D4-210A-A, D4-210A-B, D4-210I-A, D4-210I-B, D4-225A-B, D4-225A-C, D4-225I-B, D4-225I-C, D4-260A-A, D4-260A-B, D4-260A-C, D4-260D-B, D4-260D-C, D4-260I-A, D4-260I-B, D4-260I-C, D4-300A-A, D4-300A-B, D4-300D-A, D4-300D-C, D4-300I-A, D4-300I-B, D4-300I-C, D6-280A-A, D6-280A-B, D6-280I-A, D6-280I-B, D6-310A-A, D6-310A-B, D6-310D-A, D6-310D-B, D6-310I-A, D6-310I-B, D6-330A-B, D6-330A-C, D6-330D-B, D6-330D-C, D6-330I-B, D6-330I-C, D6-350A-A, D6-350A-B, D6-370A-B, D6-370A-C, D6-370D-A, D6-370D-B, D6-370D-C, D6-370I-A, D6-370I-B, D6-370I-C, D6-435D-A, D6-435D-C, D6-435I-A, D6-435I-C



18-7974
FILTRO ACEITE
Reemplaza: 3827069

Rosca: 18mm x 1.5
Para: Diesel Modelos AQD21A-B, AQD32A, MD21A/B, MD32A, TAM61A, TAM62A, TAM63L-A, TAM63P-A, TAM71A/B, TAM72A, TAM73P-A, TAM73WJ-A, TAM74A-A, TAM74A-B, TAM74C-A, TAM74C-B, TAM74P-B, TAM75P-A



18-7962
FILTRO ACEITE
Reemplaza: 3840525
Para : D1-30A, D2-40A, D2-55A, D2-55B, DE-55C, D2-75A



18-8701
FILTRO ACEITE
Reemplaza: 861476
Para: ND22A, L-A, TMD22



18-8702
FILTRO ACEITE
Reemplaza: 30788490
Para: D3-110I-G, D3-140A-G, D3-140I-G, D3-150I-G, D3-170A-G, D3-170I-G, D3-200A-G, D3-200I-G, D3-220A-G, D3-220I-G, D3-110I-H, D3-140I-H, D3-150I-H, D3-170I-H, D3-200I-H, D3-220I-H, D3-140A-H, D3-170A-H, D3-200A-H, D3-220A-H, D3-110I-D, D3-110I-E, D3-110I-F, D3-140I-E, D3-140I-F, D3-140A-D, D3-140A-E, D3-140A-F, D3-150I-D, D3-150I-E, D3-150I-F, D3-170I-D, D3-170I-E, D3-170I-F, D3-170A-D, D3-170A-E, D3-170A-F, D3-170I-D, D3-200I-E, D3-200I-F, D3-200A-D, D3-200A-E, D3-200A-F, D3-220I-D, D3-220I-E, D32-220I-F, D3-220A-D, D3-220A-E, D3-220A-F, D3-140I-D

CULATAS

*Todas las culatas son nuevas y montadas con válvulas de acero inoxidable, asientos de válvula de acero templado, muelles de válvula, semi-conos, y retenes.
Todas las culatas GM utilizan esparragos de alto rendimiento en lugar de los originales.*



18-4485 HP
CULATA
Para: 5.7L V-8 GM (1987-95) con 12 pernos en el colector admisión- (4 tornillos colector entrada a 23 grados), tapa válvulas en el centro



18-4486
CULATA
Para: 5.7L V-8 GM Vortec (1996-Sup) con 8 pernos en el colector de admisión,
Para tapa de válvula con tornillos en el dentro



18-4486HP
CULATA
Para: Vortec GM bloque pequeño 5.7L alto rendimiento
Completamente ensamblada con carreras y camaras de combustión revisadas.
Añade 30hp. de potencia sin modificaciones



18-4501
CULATA
Para: 5.0L Vortec



18-4501HP
CULATA
Para: Vortec GM bloque pequeño 5.0L
Completamente ensamblada con carreras y camaras de combustión revisadas.
Añade 30 hp de potencia sin modificaciones.





18-1400
LEVA HIDRÁLICA
Reemplaza: 3856127
GM 4.3L/V-6 último/5.0L/5.7L



18-1401
LEVA HIDRÁLICA
Reemplaza: 3853847, 985316
Ford 302/351
Ford 5.0L & 5.8L



18-1402
LEVA HIDRÁLICA
Reemplaza: 3854033, 502036
GM 2.5L/120
Para: Volvo 3.0L/181 CID GM 3.0L, 4.3L, 5.0L & 5.7L

**TODOS LOS PISTONES
SE SUMINISTRAN COMPLETOS CON ARO Y PASADOR.**



PISTONES	
STD	OMC / VOLVO #
18-4161	3853340, 914816
18-4173	*14077948
18-4173	3911020
0.02	
18-4160	3853477, 915236
0.03	
18-4164	*14077949, 3911023
* OMC Referencias GM Número	

AROS	
STD	OMC / VOLVO #
18-3937	*14089025
18-3937	328506
18-3937	3853960
18-3937	914555
18-3937	3853268
18-3937	985083, 986336
-	328536
18-3944	370409

AROS	
0.02	
18-3939	3854252
18-3939	914556
0.03	
18-3938	*14089026
18-3938	328516
18-3938	914557

APLICACIÓN PISTON / ARO

VOLVO		PISTONES			AROS			Cant. motor.
Modelo	Número serie	Std.	.020	.030	Std.	.020	Per .030	
GM								
2.5L/153 CID		18-4180	18-4183	-	18-3942	-	-	4
3.0L/181 CID		18-4161	18-4160	18-4191	18-3937	18-3939	18-3938	4
4.3L/V-6		18-4173	18-4188	18-4164	18-3937	18-3939	18-3938	6
5.0L/305 CID		-	-	18-4178	18-3944	-	-	8
5.7L/350 CID		18-4173	18-4188	18-4164	18-3937	18-3939	18-3938	8
7.4L/454 CID		18-4171	18-4189	18-4172	18-3940	-	-	8
FORD								
5.0L/302 CID		-	-	-	18-3937	18-3939	18-3938	8



COJINETE BIELA

Ref #	Medida
18-1308	Std.
18-1309	.010
18-1327	Std.
18-1332	.020
18-1333	.010
18-1334	Std.
18-1337	.010
18-1341	.020

Se venden individualmente,
1 por biela.



COJINETE CIGÜEÑAL

Ref #	Por motor	Medida
18-1311	②	Std.
18-1317	②	Std.



COJINETE LEVA

Ref #	Por motor.
18-1339	1 ②

APLICACIÓN COJINETE

Modelo	COJINETE BIELA			COJINETE BIELA			COJINETE LEVA
	Std.	.010	.020	Std.	.010	.020	

VOLVO

GM

3.0L/181 CID	18-1308	18-1309	18-1341	18-1317	-	-	18-1339
4.3L/V-6	18-1327	18-1337	-	18-1311	-	-	-
5.0L/305 CID	18-1308	18-1309	18-1341	-	-	-	-
5.7L/350 CID	18-1308	18-1309	18-1341	-	-	-	-
7.4L/454 CID	18-1334	18-1333	18-1332	-	-	-	-

FORD

5.0L/302 CID	-	-	-	-	-	-	-
--------------	---	---	---	---	---	---	---



18-0518
RETÉN VÁLVULA
Reemplaza: 3854956,
914323, 3853132
Para: mayoría de 4 y 6 cil. GM (Primeros)
y 305-350 CID GM

PACK. DE 8



18-4024
18-4024-9①
RETÉN VÁLVULA
Reemplaza:
3853226, 914445
Para: Chevy 4.3L/5.0L/5.7L



18-4031
RETÉN VÁLVULA
Reemplaza: 1306630
AQ120B, 125A, B, 131A, 140A, 145A, B,
151A, B, MD1B, 2B, 3B, 5A, 2001, 2002, 2003,
MD5B, C, 11C, D, 17C, D, 30, 31, 40, 41



18-1234
Reemplaza: 3853528
Para: 7.4L, GL, GI, GSI: 8.2L, GL
18-0519
Reemplaza: 3852657, 912957
4.3L/3.0L/5.0L 5.7L



RETENES CIGÜEÑAL
18-0528 **18-1211**
Reemplaza:
3852805



RETÉN CIGÜEÑAL
18-1213 **18-1230**
Reemplaza: 3853341 Reemplaza: 3853527

① Precio por pack

② Juego motor completo

APLICACIÓN RETÉN VOLVO

Modelo motor	2 retén principal del cigüeñal Conv. Rotación (LH)	Retén tapa Distribución
GM		
3.0L/181 CID	18-1211 ②	18-1213
4.3L/V-6	18-1211 ②	18-1213
5.0L/305 CID	18-1211 ①	18-1213
5.7L/350 CID	18-1211 ①	18-1213
7.4L/454 CID	③	18-1233
FORD		
5.0L/302 CID	18-0528	18-1230
5.8L/351 CID	—	18-1230

① Cigüeñal largo motores GM ② Para retenes de una sola pieza (LH) usar 18-0519 ③ Para retenes de una sola pieza (LH) usar PAR 18-1234

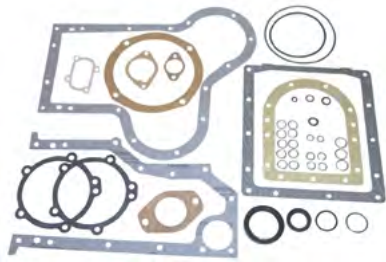

18-0252
JUEGO JUNTAS CONVERSIÓN
Reemplaza: 876314
Para: D6, D7, MD6A, MD6B, MD7A, MD7B

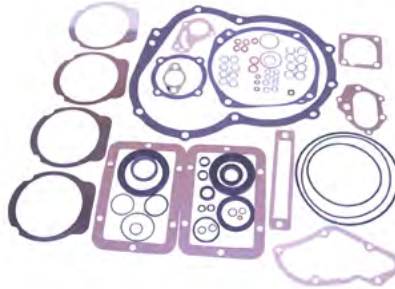

18-0489
JUEGO JUNTAS CONVERSIÓN
Reemplaza: 876384
Para: D11, MD11C, MD11D



18-2814
JUEGO JUNTAS BLOQUE CORTO
Reemplaza: 876306
(6 CIL.)



18-2699
JUEGO DE JUNTAS
Para: Colas SX y DP-SM hasta 2006
— CONTIENE —

Ref #	Descripción	O.E. #	Cant.
18-7153	Aro tórico	911851	2
18-2996	Junta	911823	1

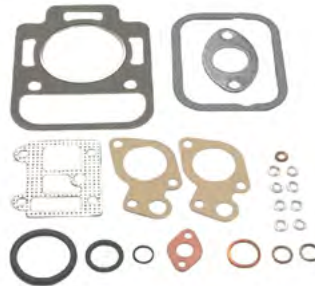

18-2596
KIT JUNTAS CULATA
Reemplaza: 875422
Para: D1, D2, D1A, MD1A, D2A, MD2, MD2A:
NOTA: Modelo MD2A requiere dos 18-2596

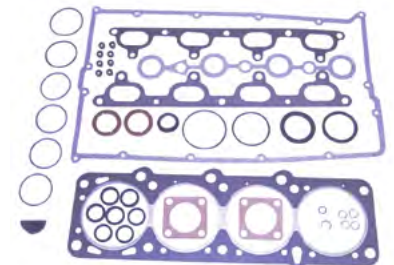

18-3870
KIT JUNTAS CULATA
Reemplaza: 876303
Para: B25, 251A, AQ171A, AQ171C

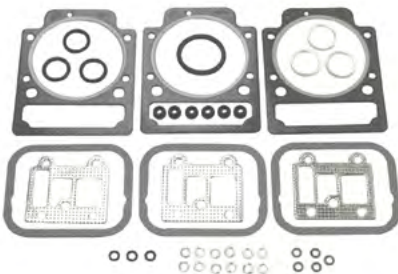

18-4341
KIT JUNTAS CULATA
Reemplaza: 876380
Para: D17, MD17C, MD17D



18-4342
KIT JUNTAS CULATA
Reemplaza: 876376
Para: D11, MD11C, MD11D



18-2813
KIT JUNTAS CULATA
Reemplaza: 876302
(4 CIL.)

APLICACIONES EN LA PÁGINA 328

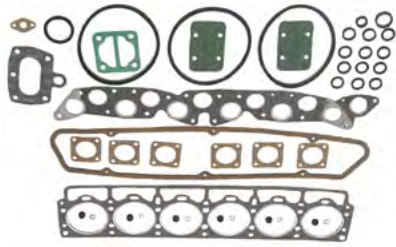

18-2817
KIT JUNTAS CULATA
 Reemplaza: 876359
 (6 CIL.)



18-2818
KIT JUNTAS CARTER
 Reemplaza: 876433
 (4 CIL.)

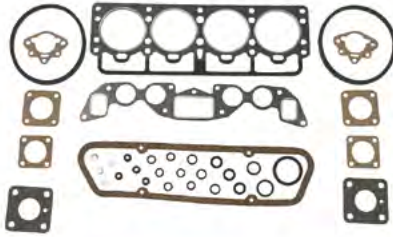

18-2980
KIT JUNTAS CULATA
 Reemplaza: 875401 (antiguo), 876356
 (4 CIL.)



18-2982
KIT JUNTAS CULATA
 Reemplaza: 875569 (antiguo), 876358
 (4 CIL.)

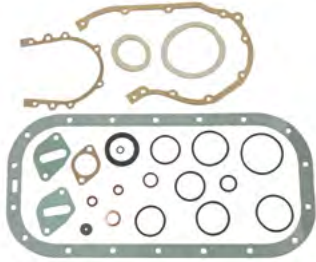

18-2983
KIT JUNTAS CARTER
 Reemplaza: 875400 (antiguo), 876342
 (4 CIL.)



18-2998
KIT JUNTAS CULATA
 Reemplaza: 876300
 (4 CIL.)



18-0410
KIT JUNTAS COLECTOR ADMISIÓN
 Reemplaza: 3853912, 3853913, 3854406
 Para: Volvo 5.0L FL, FI, 5.8L FL, FI, FSI



18-0868
KIT JUNTAS COLECTOR ADMISIÓN
 Reemplaza: 3854269



18-1238
KIT JUNTAS ADMISIÓN
 Reemplaza: 3850379, 912979
 Para: Volvo 4.3GL/GS 1994-96, 4.3Gi 1995-97



18-0498
JUNTA CULATA
 Reemplaza: 3580309
 Para: MD2030A, MD2030B



18-2946
JUNTA CULATA
 Reemplaza: 3853336, 908611
 Para: motor GM 181 (3.0L) CID .



18-2965
JUNTA CULATA
 Reemplaza: 419310, 419763-8
 (4 CIL.)



18-2966
JUNTA CULATA
 Reemplaza: 462623
 (4 CIL.)

APLICACIONES EMPIEZAN EN LA SIGUIENTE PÁGINA



18-2968
JUNTA CULATA
Reemplaza: 1378645
(4 CIL.)



18-2970
JUNTA CULATA
Reemplaza: 1378646
(4 CIL.)

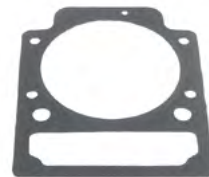

18-3834
JUNTA CULATA
Reemplaza: 833453



18-3842
JUNTA CULATA
Reemplaza: 833274
Para:D1,D2, MD1A, MD2A

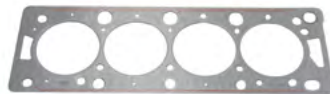

18-3867
JUNTA CULATA
Reemplaza: 859647
Para:MD22A, MD22L-A, MD22L-B,
MD22P-B, TAMD22P-B, TMD22A, TMD22B



18-3869
JUNTA CULATA
Reemplaza: 3584202
Para:MD2040A, MD2040B



18-3868
JUNTA CULATA
Reemplaza: 3583786
Para:D41, D42, D43, D44, AD41A, AD41B, AD41D, AD41L-A, AD41P-A, AQAD41A, D41A, D41B,
D41D, D41L-A, TAMD41A, TAMD41B, TAMD41D, TAMD41H-A, TAMD41L-A, TAMD41M-A,
TAMD41P-A, TMD41A, TMD41B, TMD41D, TMD41LA, KAD42A, KAD42B, KAD42P-A, KAMD42A,
KAMD42B, KAMD42P-A, TAMD42B, TAMD42WJ-A, KAD43P-A, KAMD43P-A, KAD44P-A, KAD44P-
B, KAD44P-C, KAMD44P-A, KAMD44P-B, KAMD44P-C



18-3876
JUNTA CULATA
Reemplaza: 841207-4, 856474-2
Para: GM 305 (motor 5.0L)/350 (5.7L) CID.



18-3879
JUNTA CULATA
Reemplaza: 3854299,
912227, 914930
Para: motor GM 262 (4.3L) CID.























18-3883
JUNTA CULATA
Reemplaza: 3853732
Para: motor Ford 302 (5.0L) 351 (5.8L) CID.

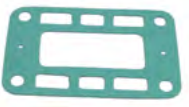

18-3887
JUNTA CULATA
Reemplaza: 3853511
Para: Volvo 7.4L

APLICACIONES KIT JUNTA CULATA/KIT JUNTAS/JUNTA CULATA

Modelo	Kit junta culata	Kit junta	Junta Culata	Modelo	Kit Junta culata	Kit Junta	Junta Culata	Modelo	Kit junta culata	Kit Junta	Junta Culata
AQ60	—	18-2983	—	AQ140A	18-2998	18-2818	18-2968	BB115C	—	—	18-2966
AQ90	—	18-2983	—	AQ145A	—	18-2818	18-2970	BB140A	18-2998	18-2818	18-2968
AQ95	—	18-2983	—	AQ145B	18-2813	—	18-2970	BB145A	18-2999	18-2818	—
AQ100	—	18-2983	—	AQ151A,B,C	18-2813	—	18-2970	BB165	—	18-2814	—
AQ105	—	18-2983	—	AQ165	—	18-2814	—	BB170C	18-2817	18-2814	18-2811
AQ110	—	18-2983	—	AQ170A	—	18-2814	—	BB30	—	18-2983	—
AQ115	—	18-2983	—	AQ170B	18-2816	18-2814	—	MB18	—	18-2983	—
AQ115A	18-2980	—	18-2965	AQ170C	18-2817	18-2814	18-2811	MB20	—	18-2983	—
AQ115B,C	—	18-2982	18-2966	AQD2B	18-2985	—	18-3833	MB20A	18-2981	—	—
AQ120A	—	18-2983	—	B20 (0.8MM)	—	—	18-2965	MB20B	18-2980	—	18-2965
AQ120B	18-2998	18-2818	18-2968	B20 (1.2MM)	—	—	18-2966	MB20C	18-2982	—	18-2966
AQ125A	18-2998	18-2818	18-2968	B21	—	—	18-2968	MD11C,D	—	—	18-3834
AQ125B	18-2813	—	18-2970	B23	—	—	18-2970	MD17C,D	—	—	18-3834
AQ130	—	18-2983	—	B30 (0.8MM)	—	—	—	MD1B	—	—	—
AQ130A	18-2980	—	18-2965	B30 (1.2MM)	—	—	18-2811	MD2B	18-2985	—	—
AQ130B	—	—	—	BB30	—	18-2983	—	MD3B	—	—	—
AQ130C	18-2980	—	18-2965	BB100	—	18-2983	—	230A,B	18-2813	—	—
AQ130D	18-2982	—	18-2966	BB115A,B	—	—	—	250A,B	18-2813	—	—
AQ131A,B,C,D	18-2813	—	18-2970								

<p>Pack. de 2</p>  <p>18-0876 18-0876-9① JUNTA BOMBA COMBUSTIBLE Para GM 4.3L, 5.0L & 5.7L Reemplaza: 3852113</p>	<p>Pack. de 2</p>  <p>18-0889 18-0889-9① JUNTA BOMBA COMBUSTIBLE Para GM 4.3L, 5.0L & 5.7L Reemplaza: 3852095</p>	<p>Pack. de 2</p>  <p>18-2989 18-2989-9① JUNTA MONTAJE CARBURADOR Reemplaza: 824677 AQ115, 125A, B, 130C, D, 131A, 145A, B, 151A, B, 170, 171A</p>	<p>Pack. de 2</p>  <p>18-0398 18-0398-9① JUNTA TERMOSTATO Reemplaza: 835417</p>
<p>Pack. de 2</p>  <p>18-2933 18-2933-9① JUNTA TERMOSTATO Reemplaza: 416033, 1317466 Usar con mayoría termostato Volvo (Excepto AQ175, V-8, MD1A)</p>	<p>Pack. de 2</p>  <p>18-2858 18-2858-9① JUNTA ALOJAMIENTO TAPA TERMOSTATO Reemplaza: 3852127 Para: 3.0L GS, GL, GLM, GLP, GSM, GSP</p>	<p>Pack. de 2</p>  <p>18-0164 18-0164-9① JUNTA ALOJAMIENTO TER- MOSTATO Reemplaza: 3852096 Para: 3.0L GS, GL</p>	<p>Pack. de 2</p>  <p>18-0929 18-0929-9① JUNTA TERMOSTATO Para: 3.0L GS, GL</p>
 <p>18-0183-1 JUNTA COLECTOR ESCAPE Reemplaza: 3853742, 3852455</p>	 <p>18-0680 JUNTA COLECTOR ESCAPE Reemplaza: 3853256</p>	 <p>18-0418 JUNTA COLECTOR ESCAPE Reemplaza: 3852472 Para: Volvo 7.4L GL, GI, GSI, 8.2L GL, GI, GSI</p>	<p>Pack. de 2</p>  <p>18-2909 18-2909-9① JUNTA COLECTOR ESCAPE Reemplaza: 856116, 3853412 Para: Volvo 4.3GL, GS, GI, GXI, OSI</p>
 <p>18-2971-1 JUNTA COLECTOR ESCAPE Reemplaza: 856039, 835908 AQ200, 225, 260, 271, 290, 311</p>	 <p>18-2925 JUNTA COLECTOR ESCAPE Reemplaza: 461092 (antiguo), 1378913 AQ165, 170B, BB165, 170 6 Cil.</p>	 <p>18-2922 JUNTA COLECTOR ESCAPE Reemplaza: 418870 (antiguo), 1378911 AQ90, 95, 100, 105, 110, 115, 120, 120A, 130, BB30, 100, 115, MB18, 20 4Cil.</p>	 <p>18-2815 MER8146801 OEM JUNTA TAPA VÁLVULAS Reemplaza: 3852692 Para: 3.0L</p>
 <p>18-1231 JUNTA ADMISIÓN Reemplaza: 3854095 Para: Volvo 7.4L GL, GI, GSI, 8.2L GL</p>	<p>Pack. de 2</p>  <p>18-2995 18-2995-9① JUNTA INTERCAMBIADOR CALOR Reemplaza: 856037 AQ120B, 125A, B, 140A, 145A,B</p>	 <p>18-2928 JUNTA COLECTOR ESCAPE Reemplaza: 824633, 856044 AQ105, 115, 130, BB115, MB20 4 Cil.</p>	 <p>18-2930 JUNTA COLECTOR ESCAPE Reemplaza: 1266796 (antiguo), 1378879 AQ125A, B, 145A, B, 131A, 151A, B, 120B, 140A</p>

① Precio por pack

Pack. de 2



18-2949
18-2949-9^①
JUNTA COLECTOR ESCAPE
Reemplaza: 835966, 856034
AQ200, 225, 260, 271, 290, 311
V-8

Pack. de 4



18-2991-1
18-2991-9^①
JUNTA COLECTOR ESCAPE
Reemplaza: 855967, 855383
AQ120B, 125A, B, 131, 140,
145, 151, B21, B23

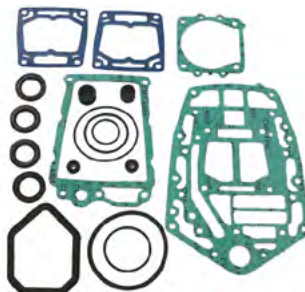

18-2974
JUNTA TAPA VÁLVULA
Reemplaza: 418265
Para: AQ90, 95, 100, 105, 110, 115, 120,
130, 165, 170, MB18, 20, BB30, 100



18-0311
JUNTA TAPA VÁLVULA
Reemplaza: 3854942
Para: 4.3 Litro
262 CID



18-0664
JUNTA TAPA VÁLVULA
Reemplaza: 3852687
Para: GM 305/350, 5.0 & 5.7L



18-0347
JUNTA TAPA VÁLVULA
Reemplaza: 3852693
Para: GM 153 & 181 CID
(2.5L & 3.0L)



18-0352
JUNTA TAPA VÁLVULA
Reemplaza: 3852818
Para: Ford 302/351 CID (5.0L & 5.8L)



18-2923
JUNTA TAPA VÁLVULA
Reemplaza: 419678
AQ105, 115, 120, 130,
BB115, MB20
4 Cil.



18-2924
JUNTA TAPA VÁLVULA
Reemplaza: 430039
AQ165, 170, BB165, 170
6 Cil.



18-2927
JUNTA TAPA VÁLVULA
Reemplaza: 463999 (antigua),
1378909
AQ120B, 125A, 140A, 145A, BB140, 145A
4Cil.



18-2972
JUNTA TAPA VÁLVULA
Reemplaza: 1378870
AQ125B, 145B, 131A, 151A, B



18-2926
JUNTA CARTER
Reemplaza: 463587 (antigua),
1378864
AQ90, 95, 100, 105, 110, 115,
120, 120B, 125A, B, 130, 131A, 140A,
145A, B, 151A, B, 171A



18-0307
JUNTA CARTER
Reemplaza: 861250
Para: D30, D31, D32, AD300A, AQAD30A,
MD30A, TAMD30A, TMD30A, AD31A,
AD31B, AD31D, AD31L-A, AD31P-A,
AD31XD, AQAD31A, MD31A, TAMD31A,
TAMD31B, TAMD31D, TAMD31L-A, TAM-
D31M-A, TAMD31P-A, TMD31A, TMD31B,
TMD31D, TMD31L-A, KAD32P-A



18-0310
JUNTA CARTER
Reemplaza: 861251
Para: D40, D41, D42, D43, D44, D300, AD40A,
AQAD40A, AQAD40B, AQD40A, MD40A,
TAMD40A, TAMD40B, TMD40A, TMD40B,
TMD40C, AD41A, AD41B, AD41D, AD41L-A,
AD41P-A, AQAD41A, D41A, D41B, D41D,
D41L-A, TAMD41A, TAMD41B, TAMD41D,
TAMD41H-A, TAMD41L-A, TAMD41M-A,
TAMD41P-A, TMD41A, TMD41B, TMD41D,
TMD41L-A, KAD42A, KAD42B, KAD42P-
A, KAMD42A, KAMD42B, KAMD42P-A,
TAMD42B, TAMD42WJ-A, KAD43P-A, KAM-
D43P-A, KAD44P-A, KAD44P-B, KAD44P-C,
KAMD44P-C, KAMD44P-B, KAMD44P-C,
KAD300, KAMD300A



18-1237
JUNTA CARTER
Reemplaza: 3856138
Para: GM 5.7L



18-1239
JUNTA CARTER
Reemplaza: 3853343
Para: Volvo 3.0L



18-0405
JUNTA CARTER
Reemplaza: 3852655
Para: Volvo 4.3L



18-1232
JUNTA CARTER
Reemplaza: 3853510
Para: Volvo 7.4L GL, GI, GSI, 8.2L GL



18-0903
JUNTA BOMBA AGUA
Reemplaza: 3853361
454 CID



18-2518
JUNTA BOMBA AGUA
Reemplaza: 430017
Para: Volvo AQ165A,
170A, B, C



18-0327
JUNTA BOMBA AGUA
Reemplaza: 3853342
4 & 6 Cil.



18-0891
18-0891-9^①
JUNTA BOMBA AGUA
Reemplaza: 3852477
Para: GM 4.3L, 5.0L & 5.8L

Pack. de 2

<p>Pack. de 2</p>  <p>18-0893 18-0893-9① JUNTA BOMBA AGUA Reemplaza: 3850595 GM 4.3L, 5.0L & 5.7L</p>	<p>Pack. de 2</p>  <p>18-0147 JUNTA BOMBA AGUA Para Ford V-8 Reemplaza: 3852824</p>	<p>Pack. de 2</p>  <p>18-2979-9① JUNTA BOMBA AGUA Reemplaza: 1378906 AQ120B, 125A, 140A, 145A</p>	 <p>18-2531 ARO Reemplaza: 834476 Para: AQ120B, 125A, 140A, 145A, B</p>
 <p>18-0468 JUNTA TAPA DISTRIBUCIÓN Reemplaza: 3852654, 3853512 GM 4.3L, 5.0L & 5.7L</p>	<p>PKG. OF 2</p>  <p>18-0887 18-0887-9① JUNTA TAPA DISTRIBUCIÓN Reemplaza: 3852691 4 & 6 Cil.</p>	 <p>18-25250 ARO SELLADO Reemplaza: 3863085 Para: Volvo SX-A/DPS-A (2007 & sup)</p>	 <p>18-25251 ARO SELLADO Reemplaza: 853868 Para: Volvo SX hasta 2006</p>
<p>Pack. de 2</p>  <p>18-2519 18-2519-9① ARO SELLANTE Reemplaza: 831622 Para pipeta refrigeración agua 120B, 125A, B, 131A, 140A, 145A, B, 151A, B, 171A</p>	<p>Pack. de 5</p>  <p>18-2525 18-2525-9① ARO SELLANTE Reemplaza: 430018 Bomba circulación culata AQ165A, 170A, B, C</p>	<p>Pack. de 5</p>  <p>18-2526 18-2526-9① ARO SELLANTE Reemplaza: 430172 Bomba circulación culata AQ165A, 170A, B, C</p>	<p>Pack. de 5</p>  <p>18-2527 18-2527-9① ARO SELLANTE Reemplaza: 831617 Para pipeta refrigeración agua AQ165A, 170A, B, C, MD21A (S/N MD-103387 & UP), MD21B</p>
<p>Pack. de 5</p>  <p>18-2528 18-2528-9① ARO SOPORTE Reemplaza: 831891 AQ120B, 125A, B, 140A, 145A, B</p>	<p>Pack. de 5</p>  <p>18-2529 18-2529-9① ARO SELLADO Reemplaza: 831892 AQ120B, 125A, B, 140A, 145A, B</p>	 <p>18-4259 ARANDELA Reemplaza: 804261</p>	<p>Pack. de 5</p>  <p>18-2530 18-2530-9① ARO SELLANTE Reemplaza: 1336255, 3547991 Bomba circulación culata AQ120B, 125A, B, 131A, 140A, 145A, B, 151A, B, 171A</p>
<p>Pack. de 2</p>  <p>18-2934 18-2934-9① RETÉN GOMA Reemplaza: 829714 AQ90, 95, 100, 105, 110, 115, 120, 130, MD5A, B, C, 7A, B, 11D, MD2001, 2002, 2003T</p>	<p>Pack. de 2</p>  <p>18-2935 18-2935-9① RETÉN GOMA Reemplaza: 418411 AQ90, 95, 100, 105, 110, 115, 120, 130, MB18, 20, BB30, 100, MD11C, D, 17C, D, MD2001, 2002, 2003, 2003T</p>	<p>Pack. de 2</p>  <p>18-2936 18-2936-9① RETÉN GOMA Reemplaza: 418445 AQ90, 95, 100, 105, 110, 115, 120, 130, MB18, 20, BB30, 100, MD11C, D, 17C, D, 2001, 2002, 2003, 2003T</p>	<p>Pack. de 2</p>  <p>18-2937 18-2937-9① RETÉN GOMA Reemplaza: 418412 AQ90, 95, 100, 110, 120B, 125A, B, 131A, 140A, 145A, B, 151A, B, 165A, 170, 171A, MD21A, B</p>

① Precio por pack



PRONAUTIC
MARINE EQUIPMENT

Pack. de 5



18-2996
18-2996-9^①
RETÉN
Reemplaza: 3852560
3.0L GL, GS, 4.3L GL, GS, GI, 5.0L FL,
FI, 5.7L GL, GI, 5.8L FL, FI, FSI

Pack. de 2



18-0322
18-0322-9^①
JUNTA
Reemplaza: 3852656
GM 5.0L & 5.7L

Pack de 2



18-2929
18-2929-9^①
JUNTA PLATINA
Reemplaza: 856028
AQ105, 115, 130, BB115, MB20

Pack de 2



18-2939
18-2939-9^①
RETÉN GOMA
Reemplaza: 814356
AQ200, 250, 270, 275, 280, 290

Pack de 2



18-0874
18-0874-9^①
JUNTA DISTRIBUIDOR
Para GM V6 & V8
Reemplaza: 3852109

Pack. de 2



18-0943-2
18-0943-1-9^①
JUNTA CODO ESCAPE
Reemplaza: 3850496
Aplicaciones último Modelo Volvo

Pack. de 2



18-2990
18-2990-9^①
JUNTA ALOJAMIENTO
Reemplaza: 832669
AQ270, 275, 280, 290



18-2199
ESPACIADOR
Reemplaza: 832675
AQ270, 275, 280, 290

18-2945
18-29451-9^①
(Pack. de 50)
JUNTA TORNILLO DRENAJE
Para: usar con tornillo 18-2944 drain screw



18-2432
LATIGUILLO POWER
HIDRÁULICO DELANTERO
Reemplaza: 873228
Para: DP, DPX



18-2433
LATIGUILLO HIDRÁULICO
DELANTERO
Reemplaza: 873229
Para: DP, DPX



18-21751
DAMPER
Reemplaza: 3853962-3
Reemplaza: 2.5L (1986), 3.0L (1986-90), 4.3L, 5.0L, 5.7L (1986)
KW & KWB solo sufixo, 7.4L (1990-98), 8.2L (1992-93,1998)



18-21752-1
DAMPER
Reemplaza: 3858437-1
Para: 4.3L (1986-Actual), 5.0L (1986-88, 1998-Actual),
5.7 (1986-92,1994, 1996-Actual)



18-21753
DAMPER
Reemplaza: 985727, 3853862-5
Para: motores Ford 5.0L & 5.8L (1989-96)



**18-2772-1
KIT RETÉN TRANSOM**

Para: SX transm

— CONTIENE —

Ref #	Descripción	O.E. #	Cant.
18-2100	Cojinete	3853807	1
18-2765	Fuelle	3854127	1
18-1074	Fuelle	3850426-2	1
18-2996	Retén	3852560, 911823	1
18-710-64-2	Abrazadera	853012-3	1



**18-9098
BLOQUEADOR COLAS**

Reemplaza: 174448

Juego de 2

Para todos los modelos SX hasta 2006

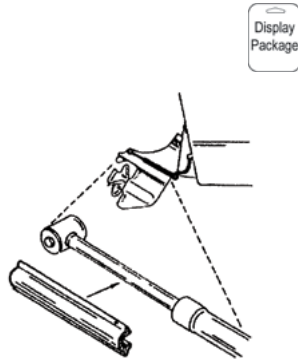

**18-9096
BLOQUEADOR COLAS**

Volvo 3847547

Para: Volvo SX-A, DPS-A (2007-Sup)

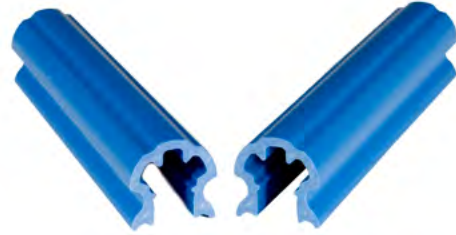

ABRAZADERA ACERO INOX

Ref #	Tamaño	O.E. #
18-7300 ① ②	50MM	—
18-7306 ① ②	38MM	853548
118-710-48-2	—	3852604
18-710-64-2	122MM	853012



**18-2744
KIT FUELLE TRANSMISIÓN**

Reemplaza: 875826, 876294

(con arista)
AQ200, 250, 270, 270T, 275, 280, 280T,
PT, 290 DP UNIT: 280, 290



**18-2755
KIT FUELLE TRANSMISIÓN**

Reemplaza: 875827

SAIL DRIVE: 100S, AQ DRIVE: 100, 100B

**18-2757
KIT FUELLE DE ESCAPE**

Con válvula

Reemplaza: 875828, 876633

AQ175, 280, 280DP, T, PT, AQD40,
AQAD40, V-8



**18-2758
KIT FUELLE DE ESCAPE**

Reemplaza: 875848, 876631

AQ200, 250, 270, 275, 280, 280DP,
290, 290DP



**18-1074
FUELLE ESCAPE**

Reemplaza: 3850426

Para: SX Drives incluye 302, 432,
434, 502, 572, 584, 744 (1994-98)
Usar 18-710-48-2 Clamp

**18-2765 CEF
18-2765S FUELLE TRANSMISIÓN**

Reemplaza: 3854127

Para: DP-S, SX



**18-2766
MANGUITO ESCAPE**

Reemplaza: 834751

(D.I. 95MM, Long 160 MM)
V-8



① Este precio es por pieza. Para pedir precio por pack, añadir 9 a la referencia.

② Precio por pack



**18-6523
KIT MUELLES**

For reverse tilt lock: Fits: AQ250, 270, 275, 275A, 280, 280DP, 280L, 285A, 290, 290A, 290DP, SP-A, SP-A/MT, SP-A1, SP-A2, DP-A, DP-A1, DP-A2, DP-B, DP-B1



**18-0184
ARO DE GOMA**
Reemplaza: 804190

Para abrazaderas: Para:230A/SP-A/MT, 250A/SP-A/MT, 500A, 501A, 571A, 740A, AQ100, AQ105, AQ110, AQ115A, AQ110B, AQ120A, AQ120B, AQ125A/B, AQ130A/B, AQ131A/D, AQ175A, AQ190A, AQ200A/C/D/F, AQ210A, AQ211A, AQ225A/B/C/D/E/F, AQ231A/B, AQ240A, AQ255A/B, AQ260A/B, AQ271A/B/C/D, AQ280A, AQ290A, AQ311A/B, AQ60F, AQ80, AQ90, AQ95, AQD19, AQD29/A, AQD32A



**18-8368
ARO DE GOMA**
Reemplaza: 813967

Para abrazaderas: 230A/SP-A/SP, A1, 230B, 250A/B, 251A, 430A/B, 431A/B, 432A, 434A, 500B, 501B, 570A, 572A, 740B, AD31A/B/D/XD, AD40B, AD41A/B/D, AQ100, AQ105, AQ110, AQ115A/B, AQ130A/B, AQ131B/C, AQ140A, AQ145A/B, AQ151A/B/C, AQ171A/C, AQ205A, AQ60F, AQ90, AQ95, AQAD30A, AQAD31A, AQAD40A/B, AQAD41A, AQD19, AQD21A/B, AQD40A, D41A/B/D, KAD32, KAD42A/B/P, KAD43P, KAD44P, KAMD42A, TAMD41A



**CRUCETA CARDAN
(Estilo Rockwell)**

Ref #	O.E. #	Aplicación
18-2104	897707, 853255	AQ200,250,270, 280,290 (Rockwell)
18-2174	3850812	3.0L GS, GL, 4.3L GL, GS, GI, 5.0L GL, GI, 5.7L GL, GI, 5.8L FL, FI, FSI



**18-6406
CRUCETA**
Reemplaza: 3860232
GKN nueva estilo con clip externo.



**18-2100
COJINETE CARDAN**
Reemplaza: 3853807
Para: OMC/Volvo- 3.0L, 4.3L, 5.0L, 5.7L, 7.4L (1994-1998), 5.8L (1994-1996), 8.2L(1998)



**18-2146
PARTE SUPERIOR CARDAN**
Reemplaza: 3850815



**18-2339
CARDAN COMPLETA**
Reemplaza: 3852384



**18-2337
PARTE INFERIOR CARDAN**
Reemplaza: 3850814
Para: 3.0L GS, GL, 4.3L GS, GL, GI, 5.0L FL, FI, 5.7L GL, GI, 5.8L FL, FI, FSI



**18-2128
HORQUILLA CARDAN**
Reemplaza: 3850813, 912213

Modelo	Cardan Completa #	O.E. Cardan Completa #	sup. Cardan #	O.E. Sup Cardan #	Short Yoke #	O.E.Short Yoke #	Doble Cardan #	O.E. Doble Cardan #
SX, DP-SM	18-2339	3852384	18-2146	3850815	18-2337	3850814	18-2128	3850813



**18-4204
CASQUILLO PLÁSTICO**
Reemplaza: 826341, 876278
AQ200, 250, 270, 275, 280, 280DP,290DP,
NO para 270T, 280T, AND 290



**18-2366
CASQUILLO INF**
Reemplaza: 876279
290, 290A, 290DP, SP-A, SP-A1 & SP-A2



**18-4205
CASQUILLO PLÁSTICO**
Reemplaza: 832820
A270T, 280T



**18-4206
TAPA COLAS**
Reemplaza: 832570
AQ200, 250, 270, 275, 280, 290



**FISH LINE
PROTECTOR ESPACIADOR**

Part #	O.E. #	Application
18-4208	839423	AQ280, 290
18-4209	839534	AQ250, 270, 275
18-4234	832965	AQ110S, 200



**18-4210
CONO HÉLICE**
Reemplaza: 850785, 854045
AQ200, 250, 270, 270T, 275, 280, 280T, 280PT, 290



**18-4211
ARANDELA PLÁSTICO**
Reemplaza: 850888



**18-3730
TUERCA MONTAJE**
Reemplaza: 3852648-9
Para: Colas SX



18-4212
TORNILLO CONO HÉLICE
Reemplaza: 850889
(5/16" - 18 rosca)



18-4213
ESPACIADOR
Reemplaza: 851261,
854047
AQ275, 280, 290



18-4214
ARANDELA CIERRE
Reemplaza: 897367
AQ: 200, 250,
270, 270T (TID UTF) 275, 280,
280T, 280PT (TID UTF)



18-4215
TORNILLO TAPA DE COLA
Reemplaza: 941816
(1/4" - 20)



18-2153
PASADOR PIVOTE
Reemplaza: 814301
AQ200, 250, 270, 275, 280



18-2454
TAPÓN DRENAJE
3/8" - 16 rosca
Reemplaza: 3854539
Para: Volvo SX drives
Usar aro 18-7145



18-3733
KIT MONTAJE HÉLICE

Para: SX Cobra
- Contiene -

Ref #	Descripción	Cant.
18-4194	Espaciador	1
18-3708-1	tuerca & ret.	1
18-3741	Pasador	1



18-4194
ESPACIADOR CAJA ENGRANAJE
Reemplaza: 3852350
Para: Caja engr. inferior modelos SX-M (1994)



18-3708-1
TUERCA HÉLICE
Reemplaza: 3850984

Pack. de 10



18-3744
18-3744-9^①
PASADOR
Reemplaza: 3852255
Para: XDP, MDSSL, MD22P, TMD22,
TMD22P, TAMD22P, PJX, SX, DPS,
DP, 3.0L GS, GL, 4.3L GL, GS, GI,
5.0L FL, FI, 5.7L GL, GI, 5.8L FL, FI, FSI

Pack. de 3



18-3745
18-3745-9^①
PASADOR
Reemplaza: 17253-6

Pack. de 5



18-4238
18-4238-9^①
TORNILLO CIERRE
Para tapa cola 18-4206
Reemplaza: 943218
AQ200, 250, 270, 275, 280, 290



18-4239
PALOMILLA CIERRE
Para tapa cola 18-4206
Reemplaza: 897873
AQ200, 250, 270, 275, 280, 290

Pack. de 5



18-4241
18-4241-9^①
PASADOR
Reemplaza: 951924
AQ200, 250, 270, 275, 280, 290

18-1501
BOLA
Reemplaza: 3852023
Para: 3.0L GS, GL, 4.3L GL, GS, GI,
5.0L FL, FI, 5.7L GL, GI, 5.8L FL, FI, FSI

Pack. de 5



18-3722
18-3722-9^①
TUERCAS APRIETE ACERO INOX
Reemplaza: 3852005
Para: PJX, SX, DPS, DP, DPX, 3.0L GL, GS,
4.3L GL, GS, GI, 5.0L FL, FI, 5.7L GL, GI,
5.8L FL, FI, FSI, 7.4L GL, GI, GSI, 8.2L GL



18-0549
TAPÓN
1"
Reemplaza: 3852476
Para: 4.3L GL, GS, GI, GSI, 5.0L FL, FI, 5.7L GL,
GI, 5.8L FL, FI, FSI, 7.4L GL, GI, GSI, 8.3L GI,
GSI, GXI, 8.2L GL, GSI



18-2138
COJINETE PIVOTE
Reemplaza: 3852544
Para: 3.0L GS, GL, 4.3L GL, GS, GI,
5.0L FL, FI, 5.7L GL, GI, 5.8L FL, FI, FSI

① Precio por pack

② Referencias acabadas en "D" are Display Packaged - Referencias normales no envasadas

El ZINC es solo para aplicaciones de agua salada.
 MAGNEASIO solo para aplicaciones agua dulce.
 ALUMINIO es tanto para agua dulce como para agua salada



① 603206 Al.
 ③ 009398 Zinc
ANODO
 Reemplaza: 873395
 Transom



① 603080 Al.
 ③ 009376 Zinc
ANODO
 Reemplaza: 872793
 Brazo dirección DPS



① 603087 Al.
 ② 18-6125M Mag.
 ③ 025492 Zinc
PLATINA TRANSOM
 Reemplaza:
 3586461 (Aluminio)
 3855610 (Magnesio)
 3854130 (Zinc)



① 603208 Al.
 ② 18-6126M Mag.
 ③ 009394 Zinc
ANODO TRANSOM
 (con tornillo)
 Reemplaza:
 3888816 (Aluminio)
 3888818 (Magnesio)
 3888817 (Zinc)
 SX-A, DPS-A, DPS-A Oxi



① 603207 Al.
 ② 18-6127M Mag.
 ③ VOL3589745 Zinc
ANODO TRANSOM
 (con tornillo)
 Reemplaza:
 3888813 (Aluminio)
 3888815 (Magnesio)
 3888814 (Zinc)
 SX-A, DPS-A, DPS-A Oxi



① 603081 Al.
 ② 18-6104 Mag.
 ③ 009347 Zinc
ANODO
 Reemplaza: 832598,
 873179
 Para 200, 250, 250C, 250D, 270,
 270B, 270C, 270D, 275, 280,
 280C, 280D, 280DP, 280L, 280PT



③ 025851 Zinc
ANODO
 Reemplaza: 838929
 AQ200 (For shield), MD19, 21, 27, 29, 32, 2003, AQ30,
 31, 40, 41
 Para refrigeración



① 603082 Al.
 ② 18-6105 Mag.
 ③ 009346 Zinc
ANODO
 Reemplaza: 852835,
 873178
 Para 290, 290A, 290ADP, 290B



① 603084 Al.
 ③ 009350 Zinc
ANODO
 Reemplaza: 875805
 AQ250, 270, 270T, 275



① 603090 Al.
 ③ 009351 Zinc
ANODO
 Reemplaza: 875815



① 603091 Al.
 ② 18-6102 Mag.
 ③ 025840 Zinc
ANODO
 Reemplaza: 3855411, 984513 (18-6028),
 3863193 (18-6028A), 3855412 (18-6102)
 Para usar con caja engranajes: 2.3L (1987-90), 2.6L/
 3.5L/4.6L (1989), 3.0L/4.3L/5.0L/5.8L (1987-93), 5.7L
 (1987-92), 7.4L (1987-88)



① 603086 Al.
 ② 18-6106 Mag.
 ③ 009352 Zinc
ANODO
 Reemplaza: 875821
 280DP, 290DP

**El ZINC es solo para aplicaciones de agua salada.
MAGNEASIO solo para aplicaciones agua dulce.
ALUMINIO es tanto para agua dulce como para agua salada**

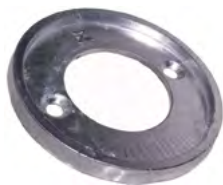

009348 Zinc
603085 Al.
Reemplaza: 875809.
Para eje de cola veleros Volvo 100S y AQ 100/B.

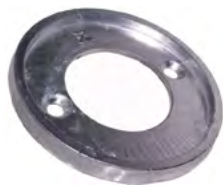

009349 Zinc
603083 Al.
Reemplaza: 875810.
Para eje de cola veleros Volvo 100S y AQ 100/B.



009345 Zinc
Reemplaza: 851983/876286.
Para eje de cola veleros Volvo 120S-E/D, 120SB, S120C, MS25S, MS25SR.



009582 Zinc
Reemplaza: 3888305.
Para cola velero Volvo propulsor Velero MS25SR-A, 120S-A/B/D/E, 130S-A/B, 130SR-A/B, 150S-A/B, 150SR-A/B.



025308 Zinc
Reemplaza: 832934
Para cola Volvo AQ270T, 280T.



025857 (par) Zinc
Reemplaza: 852018.
Para hélices plegables de 2 y 3 palas y colas de velero S110, S110S, S120, S120S, S130, S130S.



009379 Zinc
Reemplaza: 875812
Para eje de cola de veleros 110S, S110S.



025305 Zinc
Hembra para sistema de refrigeración intraborda Volvo TD, D, TAD, TMD, MD, TAM, AQD. Reemplaza: 838929.



025309 Zinc
Con tapón de latón para refrigeración Volvo TD, D, TAD, TMD, MD, TAM, AQD. Reemplaza: 823662.



009304 Zinc
Tipo Duodrop para DPH-A/B, DPR-A, Transom DPH-S/C, DPR. Peso: 0,473kg. Reemplaza: 3588745.



009397 Zinc
Reemplaza: 876638-872175.
Para Volvo DPX, DP.



025425 Zinc
Reemplaza: 3852970.
Para Volvo SX-A/C/M/S.

**El ZINC es solo para aplicaciones de agua salada.
MAGNEASIO solo para aplicaciones agua dulce.
ALUMINIO es tanto para agua dulce como para agua salada**



025458 Zinc
Reemplaza: 833913
Para hélices Volvo DP-A/D/E/S, DPX, 275, 280B, 290A, 120S.



025459 Zinc
Reemplaza: 833913
Para hélices Volvo DP-A/D/E/S, DPX, 275, 280B, 290A, 120S.



009576 Zinc
Reemplaza: 3858399.
Para hélices plegables Volvo de 2 y 3 palas, S110, S110S, S120, S120S, S130, S130S, 130S.



009396 Zinc
Reemplaza: 872139.
Para motores Volvo tipo DPX-A/R/C, DP-D/E/G.



025463 Zinc
Reemplaza: 41100276.
Para Volvo BP800/900/1200/1300, 1000H/1500H, SP900/1300.



009577 Zinc
Reemplaza: 71180
Para Volvo BP800/900/1200/1300, 1000H/1500H, SP900/1300, Seal drive, Sidepower.

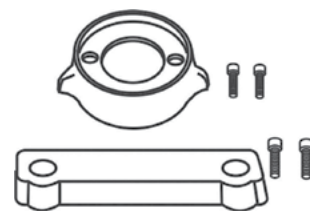

603097 Al.
Kit completo Volvo 280 con indicador y tornillería.

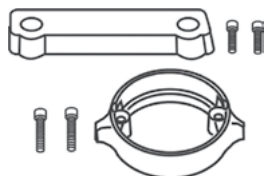

603098 Al.
Kit Completo Volvo 280 Duo Prop con indicador y tornillería.

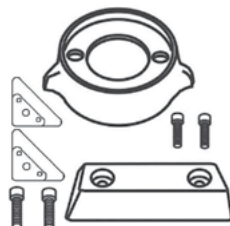

603099 Al.
Kit Completo Volvo 290 con indicador y tornillería.

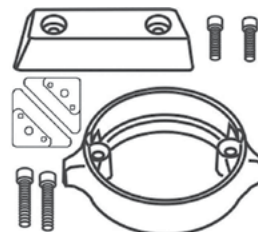

603100 Al.
Kit Completo Volvo 280 Duo Prop con indicador y tornillería.

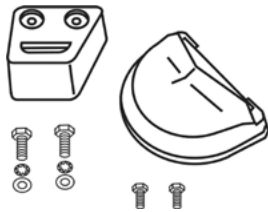

603101 Al.
Kit Completo Volvo SX con indicador y tornillería.

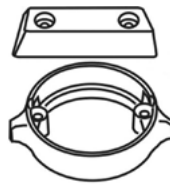

603105 Al.
Kit completo Volvo 290 Duo Prop. Sin indicador.



603107 Al.
Kit Tornillería Volvo 280.



603109 Al.
Kit Tornillería Volvo 290.

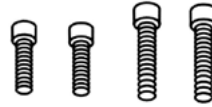

603110 Al.
Kit tornillería Volvo 290 Duo Prop.



603111 Al.
Kit Tornillería Volvo SX.



18-6130 ANODO
Reemplaza: Volvo
Para: Colas Volvo IPS



18-6131 ANODO
Reemplaza: Volvo
Para: Colas Volvo IPS



18-1076 FUELLE
Reemplaza: Volvo 3888916
Para: Colas Volvo SX-A & DPS-A



③ **18-6021 TAPÓN ANODO**
Reemplaza: 838928
AQ30, 31, 40, 41, MD10, 21, 27, 29, 32, 2003



18-2598 KIT RETÉN ALOJAMIENTO ENGRANAJE
Reemplaza: 3855275
Para: Volvo SX hasta 2006



18-2586 KIT RETÉN UNIDAD SUPERIOR
Reemplaza: 3850594
Para: Volvo SX hasta 2006

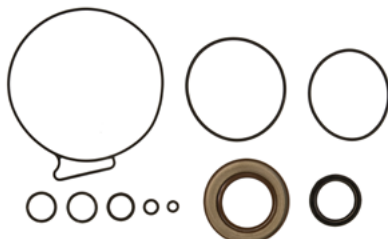

18-2726 KIT RETÉN UNIDAD SUPERIOR
Reemplaza: 3888917
Para: Volvo SX-A/DPS-A (2007 & Sup)



18-3893 KIT JUNTAS CAMBIO
Para: 275A, 280, 280DP, 280T, 285A, 290, 290A, 290DP, SP-A, SP-A/MT, SP-A1, SP-A2, SP-C, SP-C1, DP-A, DP-A1, DP-A2, DP-B, DP-B1, DP-C, DP-C1, DP-D, DP-D1, DP-E, DP-G, DPX, DPX-S, XDP-B

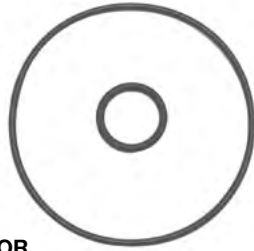

18-2597

KIT RETÉN UNIDAD SUPERIOR

Para alojamiento intermedio: Para: 200, 250, 270, 270T, 275, 275A, 280, 280DP, 280T, 285A, 290, 290A, 290DP, SP-A, SP-A/MT, SP-A1, SP-A2, SP-C, SP-C1, DP-A, CP-A1, DP-B, DP-B1, DP-C, DP-C1, DP-D, DP-D1, DP-E, DP-G, DPX, DPX-S, DPX-S1



18-3888

KIT RETÉN UNIDAD INFERIOR

Para alojamiento intermedio: Para: 200, 250, 270, 270T, 275, 275A, 280, 280DP, 280T, 285A, 290, 290A, 290DP, SP-A, SP-A/MT, SP-A1, SP-A2, SP-C, SP-C1, DP-A, CP-A1, DP-B, DP-B1, DP-C, DP-C1, DP-D



18-8357

KIT DE RETENES COMPLETO

Reemplaza: 875741
Para: 280DP/290DP

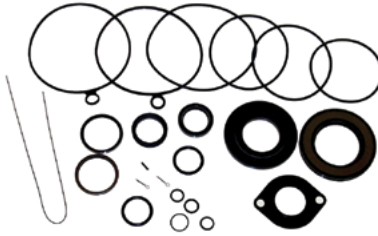

18-8361

KIT RETÉN SUPERIOR

Reemplaza: 576266-8
Para: AQ200-AQ290

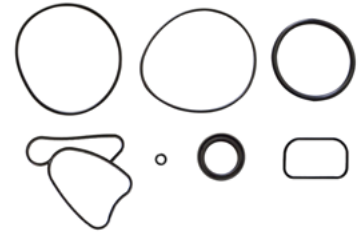

18-2583

KIT RETÉN UNIDAD INFERIOR

Reemplaza: 3888821
Para: Colas SX-A (2007 y SUP)



18-2584

KIT RETÉN UNIDAD INF

Reemplaza: 3888822
Para: Colas DPS-A (2007 y SUP)

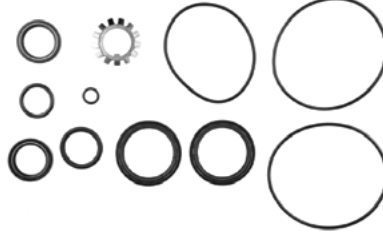

18-8358

KIT RETENES INFERIOR

Reemplaza: 876267
Para: 280DP/290DP

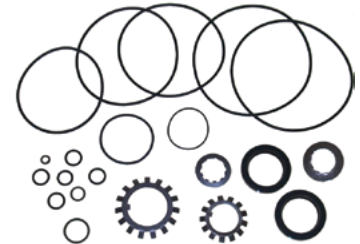

18-8359

KIT RETENES ENGRANAJE SUPERIOR

Reemplaza: 876268
Para: AQ200-AQ290



18-2791

KIT RETENES ENGRANAJE INFERIOR

Reemplaza: 3850597

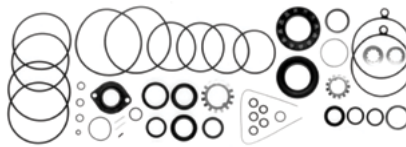

18-2625

KIT JUNTA COLAS

Reemplaza: 875192
AQ200, 250, 270, 275, 280, 290



18-32882

RETÉN TUBO AGUA

Reemplaza: 3852315



RETENES ACEITE

Ref #	O.E. #	Dimensiones (mm)		
		D.I.	D.E.	ancho
18-0558	851407	44	58.33	7
18-2039	804695	13	25.4	6
18-2040	853670	45	75	8
18-2041	897426	33	45.25	7
18-2043	958838	25	35	7
18-2044	833996	12	24	7
18-2045	827247	16	28	7
18-2046	946242	35	55	10
18-2047	958860	35	62	7
18-2057	181620	34	42	4

ARO TÓRICO



Dimensiones (mm)				Dimensiones (mm)			
Ref #	Pack.	O.E. #	D.I. ancho	Ref #	Pack.	O.E. #	D.I. ancho
18-7122		925095	—	18-7182⓪	5	925092	55 3
18-7154		949656	—	18-7183⓪	5	925093	69.5 3
18-7102⓪	5	3852073	.430 .065	18-7184⓪	5	925256	79 3
18-7116		3852045	.360 .10	18-7186⓪	5	925259	102 3
18-7135		3852089	.750 .135	18-7187⓪	5	925261	106 3
18-7141⓪	5	3852165	.180 .065	18-7188⓪	5	955983	9.1 1.6
18-7143⓪	5	3852169	1.310 .100	18-7190⓪	5	925065	34 3
18-7149⓪	5	955989	15 1.5	18-7192⓪	5	955995	25.1 1.6
18-7162⓪	5	3852044	2.025 .135	18-7193⓪	5	955974	10.3 2.4
18-7168⓪	5	3852033	.370 .065	18-7194⓪	5	956000	37.1 1.6
18-7178⓪	5	125017	23.5 3.5	18-7406⓪	5	3852523	.250 .065
18-7180⓪	5	925055	11.3 2.4	18-7407⓪	5	3852531	4.125 .135
18-7181⓪	5	925091,975672	50.5 3				

⓪ Este producto es precio por pieza. Para pedir envasado añada 9 a la referencia. Referencia normal no envasada.

DIESEL SISTEMA ELÉCTRICO



**18-6953
ALTERNADOR**

Reemplaza: Volvo 3803645, 8602629, 8602710, 14 8676496, 98, 8676499
Para: Modelos Diesel D3



**18-6955
ALTERNADOR**

Reemplaza: Caterpillar 3001117, 10-258
Prestolite 110-258, 110-258A
Volvo 849748-9
Para: modelos Volvo Diesel 6 cilindros



**18-6846
ALTERNADOR**

Reemplaza: Volvo Penta 1502272, 3803270-2, 5001677, 845940, 72021, 872022, 872757, 873635, 873757, 873757-9, 873771



**18-6872
ARRANQUE
12 Volt**

Reemplaza: Volvo 233991, 240501, 837924, 842775, 843511, 847306-8, 881681
Para: Modelos TAMD, MD, AQD

**18-6944
ARRANQUE**

Reemplaza:
Volvo 21323043, 3583555
Bosch 0-001-109-035
Caterpillar 163-3361
Perkins 185086600
Para: 2001-07 D2-55A, B, C, 2003-07 D2-75A, 4 cil 134.2cu in. 2.2L



VOLVO ALTERNADOR/APLICACIÓN ARRANQUE

Modelo	Año	Arranque	Alternador	Amps	Valeo Ref No.
2001	1983-1993	—	18-5943	50	—
2002, T	1983-1993	18-6839	18-5943	50	—
2003, T	1983-1993	18-6839	18-5943	50	—
AD290	TODOS	—	18-5943	50	—
AD31 A, B, D, L, P, X	1986-2004	—	18-6846	60	—
AD31 A, B, D, L, P, X	1986-2004	—	18-5943	50	—
AD41D	TODOS	—	18-5943	50	—
AQAD30A	1983-1986	—	18-5943	50	A13N259
AQAD30A	1983-1986	—	18-59700	50	A13N234
AQAD31A	1986-1989	—	18-5943	50	A13N259
AQAD31A	1986-1989	—	18-59700	50	A13N234
AQAD40A, B	1980-1986	—	18-5943	50	A13N259 OR A13N1M
AQAD40A, B	1980-1986	—	18-59700	50	—
AQAD41	TODOS	—	18-5943	50	A13N259
AQAD41	TODOS	—	18-59700	50	A13N234
AQAD41A, B, C	1986-1994	—	18-5943	50	A13N259 OR A13N1M
AQAD41A, B, C	1986-1994	—	18-59700	50	A13N234
AQD32A	1969-1977	—	18-5943	50	A13N1M
AQD32A	1969-1977	—	18-59700	50	A13N234
AQD40A, B	1977-1986	—	18-5943	50	A13N259
AQD40A, B	1977-1986	—	18-59700	50	A13N234
AQD41	TODOS	—	18-5943	50	A13N259
AQD41	TODOS	—	18-59700	50	A13N234
AQD41A	1986-1989	—	18-5943	50	A13N259
AQD41A	1986-1989	—	18-59700	50	A13N234
AQD70B, BL, C, CL, D	1971-1982	18-6872	18-6846	55	—
B21	TODOS	—	18-5943	50	A13N2M
B21	TODOS	—	18-59700	50	—
B23	TODOS	—	18-5943	50	A13N2M
B23	TODOS	—	18-59700	50	—
D12-650	2006-2007	—	18-6846	60	—
D12-715	2002-2004	—	18-6846	60	—
D12C	1999-2004	—	18-6846	60	—
D12-MH	2005-2007	—	18-6846	60	—
D2-55A	TODOS	—	18-5939	50	—

VOLVO ALTERNADOR/APLICACIÓN ARRANQUE

Modelo	Año	Arranque	Alternador	Amps	Valeo Ref No.
D25A	TODOS	—	18-5959	50	—
D30A	TODOS	—	18-5959	50	—
D3-110	2003-2007	—	18-6953	140	—
D3-130	2003-2007	—	18-6953	140	—
D3-160	2003-2007	—	18-6953	140	—
D3-190	2003-2007	—	18-6953	140	—
D41D	TODOS	—	18-5943	50	—
D49A	TODOS	—	18-5959	50	—
D63	TODOS	—	18-5939	50	—
D71, D	TODOS	—	18-5939	50	—
D73	TODOS	—	18-5939	50	—
KAD32P	1996-2005	—	18-6846	60	—
KAD42A, B, P	1991-2001	—	18-5943	50	A13N259
KAD42A, B, P	1991-2001	—	18-59700	50	A13N234
KAMD42A B, P	1991-1997	—	18-5943	50	A13N259
KAMD42A B, P	1991-1997	—	18-59700	50	A13N234
MD100	TODOS	—	18-6846	55	—
MD100A, B	1965-1984	—	18-6846	60	—
MD11	TODOS	—	18-59700	50	A13N234
MD11C	1975-1981	—	18-5943	50	A13N57M OR A13N1M
MD11C	1975-1981	—	18-59700	50	—
MD120	TODOS	—	18-6846	55	—
MD120A	1970-1980	—	18-6846	60	—
MD17	1975-1981	—	18-5943	50	A13N2M
MD17	1975-1981	—	18-59700	50	A13N234
MD17C	1975-1984	—	18-5943	50	A13N2M
MD17C	1975-1984	—	18-59700	50	A13N234
MD17D	1975-1984	—	18-5943	50	A13N147M OR A13N1M
MD17D	1975-1984	—	18-59700	50	A13N234
MD18	TODOS	—	18-5943	50	A13N147M
MD18	TODOS	—	18-59700	50	—
MD21	1968-1979	—	18-5943	50	A13N147M OR A13N1M
MD21	1968-1979	—	18-59700	50	—
MD21A	1968-1979	—	18-5943	50	A13N1M
MD21A	1968-1979	—	18-59700	50	—
MD2B	1964-1975	—	18-5943	50	A13N1M
MD2B	1964-1975	—	18-59700	50	A13N234
MD2BHY	1964-1975	—	18-5943	50	A13N1M
MD2BHY	1964-1975	—	18-59700	50	—
MD30	1983-1986	—	18-5943	50	A13N147M OR A13N1M
MD30	1983-1986	—	18-59700	50	A13N234
MD30A	1983-1986	—	18-5943	50	A13N259
MD30A	1983-1986	—	18-59700	50	A13N234
MD31A	1986-1994	—	18-5943	50	A13N259
MD31A	1986-1994	—	18-59700	50	—
MD32A	1969-1977	—	18-5943	50	A13N1M
MD32A	1969-1977	—	18-59700	50	A13N234
MD3B	1971-1975	—	18-5943	50	A13N1M
MD3B	1971-1975	—	18-59700	50	A13N234
MD40A	1976-1985	—	18-5943	50	A13N259
MD40A	1976-1985	—	18-59700	50	A13N234
MD42A	1970-1979	18-6872	—	—	—
MD5	TODOS	—	18-5943	50	A13N2M OR A13N147M
MD5	TODOS	—	18-59700	50	—
MD5A, B, C	1975-1982	—	18-5943	50	A13N1M

VOLVO ALTERNADOR/APLICACIÓN ARRANQUE

Modelo	Año	Arranque	Alternador	Amps	Valeo Ref No.
MD5A, B, C	1975-1982	—	18-59700	50	—
MD6A	1971-1976	—	18-5943	35	A13N57M
MD6A	1971-1976	—	18-59700	35	A13N234
MD7	TODOS	—	18-5943	50	A13N147M OR A13N2M
MD7	TODOS	—	18-59700	50	A13N234
MD70B, C	1970-1985	18-6872	—	—	—
MD70B, C	1965-1985	18-6958	18-6846	60	—
MD7A, B	1976-1983	—	18-5943	50	A13N1M OR A13N259
MD7A, B	1976-1983	—	18-59700	50	A13N234
MD11	TODOS	—	18-5943	50	A13N2M
TAMD 120	TODOS	—	18-6955	120	—
TAMD 120 A, B	1973-1982	—	18-6955	175	—
TAMD 162 A, B, C	1988-2001	—	18-6955	175	—
TAMD102 A, D	1991-2000	—	18-6846	60	—
TAMD103A	2000-2004	—	18-6846	60	—
TAMD120	TODOS	—	18-6846	55	—
TAMD120A, B	1972-1983	18-6958	18-6846	60	—
TAMD121 C, D	1983-1988	18-6958	18-6846	60	—
TAMD121 C, D	1983-1988	18-6958	18-6846	55	—
TAMD122 A, C, D, P	1988-2002	18-6958	18-6846	60	—
TAMD162 A, B, C	1988-2001	—	18-6846	60	—
TAMD163 A, P	1994-2001	—	18-6846	60	—
TAMD163 A, P	1994-2001	—	18-6846	55	—
TAMD165A, C, P	2002-2005	—	18-6846	60	—
TAMD30, A, B, C	1983-1986	—	18-5943	50	A13N1M
TAMD30, A, B, C	1983-1986	—	18-59700	50	A13N234
TAMD31A, B, D, L, M, P, S, X	1985-2004	—	18-5943	50	A13N259
TAMD31A, B, D, L, M, P, S, X	1985-2004	—	18-59700	50	A13N234
TAMD31A, B, D, L, M, P, S, X	1985-2004	—	18-6846	60	—
TAMD40A, B, C	1979-1986	—	18-5943	50	A13N259
TAMD40A, B, C	1979-1986	—	18-59700	50	A13C234
TAMD41A	1986-1989	—	18-5943	50	A13N259 OR A13N1M
TAMD41A	1986-1989	—	18-59700	50	A13N234
TAMD60 A, B, C	1976-1987	18-6872	18-6846	60	—
TAMD61A	1986-1995	18-6872	18-6846	60	—
TAMD62A	1992-1994	18-6872	18-6846	60	—
TAMD63L, P	1994-2005	18-6872	—	—	—
TAMD70	TODOS	—	18-5943	50	A13N259
TAMD70	TODOS	—	18-59700	50	—
TAMD70	TODOS	—	18-6846	55	—
TAMD70B, C, D	1970-1987	18-6872	18-6846	60	—
TAMD70E	1983-1987	—	18-5943	50	A13N1M
TAMD70E	1983-1987	18-6872	18-59700	50	—
TAMD70E	1983-1987	18-6872	18-6846	60	—
TAMD71A, B	1986-2000	18-6872	18-6846	60	—
TAMD72A, P, W, J	1991-1997	18-6872	18-6846	60	—
TAMD73P, W, J	1997-1999	18-6872	18-6846	60	—
TAMD74A, C, L, P	1998-2005	18-6872	18-6846	60	—
TAMD75P	1998-2005	18-6872	18-6846	60	—
THAMD70B, C	1972-1979	18-6872	18-6846	60	—
TMD 100	TODOS	—	18-6955	120	—
TMD 100 B, C	1965-1988	—	18-6955	175	—
TMD100A	TODOS	—	18-6846	55	—
TMD100B, C	1965-1988	—	18-6846	60	—
TMD102A	1988-2000	—	18-6846	60	—

VOLVO ALTERNADOR/APLICACIÓN ARRANQUE

Modelo	Año	Arranque	Alternador	Amps	Valeo Ref No.
TMD120	TODOS	—	18-6955	120	—
TMD120 A,B	1970-1984	18-6958	18-6955	175	—
TMD120A, B	1970-1984	18-6958	18-6846	60	—
TMD121C	1983-1988	18-6958	18-6846	60	—
TMD122A	1988-2000	18-6958	18-6846	60	—
TMD122A	1988-2000	18-6958	18-6846	55	—
TMD30A, B	1983-1986	—	18-5943	50	A13N147M
TMD30A, B	1983-1986	—	18-59700	50	A13N234
TMD31A, B, D, L	1986-1997	—	18-5943	50	A13N259
TMD31A, B, D, L	1986-1997	—	18-59700	50	A13N234
TMD40	TODOS	—	18-5943	50	A13N147M
TMD40	TODOS	—	18-59700	50	A13N1M
TMD40A, B, C	1976-1986	—	18-5943	50	A13N259
TMD40A, B, C	1976-1986	—	18-59700	50	A13N234
TMD41A, B, D, L	1986-1997	—	18-5943	50	A13N259
TMD41A, B, D, L	1986-1997	—	18-59700	50	A13N234
TMD70B, C	1972-1985	18-6872	18-6846	60	—

DIESEL FILTRO COMBUSTIBLE

20 MICRONES

18-7942

Reemplaza:

Volvo 466987, 3825133
 Para: MD100A, TMD100A, MD100B, MD120A, TMD120A, TAMMD120A, MD120B, TMD120B, TAMMD120B, MD70B, TMD70B, TAMMD70B, THAM-D70B, AQAD70B, MD70C, TMD70C, TAMMD70C, AQD70C, TAMMD60A, TAMMD60B, TAMMD60C, D5/D7 MARINE GENSET, D5A-T, D5A-TA, D7A-T, D7A-TA, D7C-TA, D63 MARINE, D71/73 MARINE, KAD32P, TAMMD42WJ, KAD43P/44P/300, KAMD43P/44P/300, TAMMD103A, TAMMD61A, TAMMD62A, TAMMD71A, TAMMD72A, TAMMD72P, TAMMD72WJ, TAMMD74, TAMMD75 MARINE, TMD102A, TAMMD102A, TAMMD102D, TMD122A, TAMMD122A, TAMMD122P, TMD31L, TAMMD31P/L/M/S, AD31P/L, TMD41L, TAMMD41P/L/M/H



20 MICRON



18-7858

Reemplaza: Volvo 858201

Para: CAV Tipo unidad
 Para: AQ120B, 125A, B, 131A, 140A, 145A,B, 151, BB, 140,145A



18-8124

Reemplaza: Volvo 829913
 Para: 2001, 2001B, 2002, 2002B, 2003, 2003B/T/TB, AQD2B, MD11C/D, MD17C/D, MD1B, MD2B, MD3B, MD5A/B/C, MD7/B

18-8125

Reemplaza: Volvo 3583443

Para: D4-180i-B, D4-180i-C, D4-210A-A, D4-210A-B, D4-210i-A, D4-210i-B, D4-225A-B, D4-225A-C, D4-225i-B, D4-225i-C, D4-260A-A, D4-260A-B, D4-260A-C, D4-260D-B, D4-260D-C, D4-260i-A, D4-260i-B, D4-260i-C, D4-300A-A, D4-300A-C, D4-300D-A, D4-300D-C, D4-300i-A, D4-300i-C, D6-280A-A, D6-280A-B, D6-280i-A, D6-280i-B, D6-310A-A, D6-310A-B, D6-310D-A, D6-310D-B, D6-310i-A, D6-310i-B, D6-330A-B, D6-330A-C, D6-330D-B, D6-330D-C, D6-330i-B, D6-330i-C, D6-350A-A, D6-350A-B, D6-370A-B, D6-370A-C, D6-370D-A, D6-370D-B, D6-370D-C, D6-370i-A, D6-370i-B, D6-370i-C, D6-435D-A, D6-435D-C, D6-435i-A, D6-435i-C



18-8126

Reemplaza: Volvo 861477
 Para: D1-13 A, D1-13 B, D1-20 A, D1-20 B, D1-30 A, D1-30 B, D2-40 A, D2-40 B, D2-55 A, D2-55 B, D2-55 C, D2-55 D, D2-55 E, D2-55F, D2-75 A, D2-75 B, D2-75 C, D2-75F, MD2010A, MD2010B, MD2020A, MD2020B, MD2030A, MD2030B, MD2040A, MD2040B



18-35443

BOMBA COMBUSTIBLE

Reemplaza: Volvo 3582310

Para: Motores diesel Volvo D30, D40, D31, D41, D42



18-35444

BOMBA COMBUSTIBLE

Reemplaza: Volvo 858459

Para: Motores diesel Volvo antiguos D21 y D32

18-7783 JUEGO JUNTAS BOMBA COMBUSTIBLE

Reemplaza: Volvo 273663

Para: D30, D31, D32, D40, D42, D44, AD30A, AQAD30A, TAMD30A, TMD30A, AD31A, AD31B, AD31D, AD31XD, AQAD31A, MD31A, TAMD31A, TAMD31B, TAMD31D, TMD31A, TMD31B, TMD31D, KAD32P-A, AD40B, AQAD40A, AQAD40B, AQ-D40A, MD40A, TAMD40A, TAMD40B, TMD40A, TMD40B, TMD40C, AD41A, AD41B, AD41D, AQAD41A, D41A, D41B, D41D, TAMD41A, TAMD41B, TAMD41D, TMD41A, TMD41B, TMD41D, KAD42A, KAD42B, KAD42P-A, KAMD42A, KAMD42B, KAMD42P-A, TAMD42B, TAMD42WJ-A, KAD43P-A, KAMD43P-A, KAD44P-A, KAMD44P-A



FILTRO ACEITE

Los filtros de aceite SIERRA están fabricados con materiales de alta calidad:

- Capa de epoxy de gran resistencia a la corrosión.
- Recipiente de acero extra-resistente.
- Elemento filtrante de alta eficiencia.
- Cubierta por la garantía Sierra.

DIESEL FILTRO ACEITE



18-0032
Reemplaza:
Volvo 847741



18-0033
Reemplaza:
Volvo 478736



18-0034
Reemplaza:
Volvo 477556



18-0035
Reemplaza:
Volvo 3582732
Caudal completo



18-0036
Reemplaza:
Volvo 3582733
Bypass



18-7880
Reemplaza:
Caterpillar 1R-0658
Volvo-Penta 466634



***18-7884**
Reemplaza:
Universal 299381
Volvo-Penta 834337
Rosca Espec: 3/4" x 16NPT

*Anti-Drenaje-Válvula de retroceso. Elimina los arranques en seco, la válvula evita que el aceite vuelva al cárter durante el apagado del motor.





VOLVO



POTENCIA HP	NGK STD.	Ref. PRONAUTIC	POTENCIA HP	CHAMPION	Ref. PRONAUTIC
SERIES AQ			SERIES AQ		
145A, B	BP7ES	050821	120 (B21)	RN7YC	050979
130, A, B, C, D	BP7HS	050822	125A,B, 145	RN7YC	050979
131, A, B, C, D, 140A	BP7ES	050821	130, A, B, C, D	RL82YC	050952
150, A, B	XR5	050606	131, A, B,C ,D	RN7YC	050979
151A, B, C	BP7ES	050821	140, A, 145A,B	RN7YC	050979
165A, 170, A, B, C	BP7HS	050822	151 A,B,C	RN7YC	050979
171A, C	BP6ES	050819	165 A	RL82YC	050952
175, 175A	YR5	050709	170, A, B, C	RL82YC	050952
180	XR5	050606	171 A, C	RN9YC	050948
190	YR5	050709	175, 175A	RV15YC4	050928
200, A, B, C, D, F	UR5	050607	180	RJ12YC	050980
210A DESDE from 177315	UR6	050608	190 FORD, 190A FORD	RV15YC4	050928
211/DP, 211A	YR5	050709	200, A, B, C, D, F, 205A	RV15YC4	050928
225, A, B, C, D	UR6	050608	210A DESDE from 177315	RV9YC	050930
225E,F	YR5	050709	211A, 211/DP,231D/P, 271D/P	RV15YC4	050928
230A, B, 250A, B	BPR6ES	050826	255, A, C	RV15YC4	050928
231/DP, 231A,B	YR5	050709	255D, 305 CID, 225E,F	RV15YC4	050928
240A, 255B	UR6	050608	230A/B, 250A/B	RN7YC	050979
260, A, B	BR6FS	050831	231A, B, 240A FORD, 255B, 280A	RV15YC4	050928
271/DP	YR5	050709	260A, B, 271A, B, C, D, 290, A,	RV15YC4	050928
271A, B, C, D	BR6FS	050831	311, A, B, 430, 531, 500A, 501A	RV15YC4	050928
280A	UR6	050608	570A, 571A, 572, 740A	RV15YC4	050928
290A, 290B, 311A, 311B	BR6FS	050831	SERIES B/BB		
430, 500A, 501A, 531, 570A	BR6FS	050831	18A, 18C, 30B	RL82C	050924
571A, 572, 740A	BR6FS	050831	100, A	RL86C	050925
SERIES DPX			115A, B, 165A	RL82YC	050952
5.7L DPX 375	TR55	050877	140	RN9YC	050948
7.4L DPX 385 GSi EFI	BR6FS	050831	145, A	RN7YC	050979
8.1L DPX 420	TR55	050877	SERIES OCEAN		
8.2L DPX 415 GSi EFI	BR6FS	050831	GM V-6, 2002 4.3L OSi-XDP	RS12YC	050949
SERIES DUOPROP			GM V-8, 2002 5.0L OSi-XDP	RS12YC	050949
4.3L Gi EFI (.460 Rch.)	BPR6FS	050700	GM V-8, 2002 5.7L OSi-XDP	RS12YC	050949
4.3L Gi EFI (.708 Rch.)	BPR6EFS	050857	GM V-8, 2002 5.7L OSXi-XDP	RS12YC	050949
4.3L GL 2 bbl, GS 4	BPR6EFS	050857	PJX Water Jet		

VOLVO PENTA
Bujías



VOLVO



POTENCIA HP	NGK STD.	Ref. PRONAUTIC	POTENCIA HP	CHAMPION	Ref. PRONAUTIC
5.0L Fi EFI	TR5	050708	4.3L Gi, GS	RS12YC	050949
5.0L FL 2 bbl	UR4	050878	SERIES SX Cobra		
5.0L Gi, GL Gen 1+	BPR6EFS	050857	3.0L GS	RS12YC	050949
5.7L Gi EFI	BPR6FS	050700	4.3L GIPNCA	RV15YC4	050928
5.7L GL 2 bbl	BR6FS	050831	4.3LGIPNCS	RS12YC	050949
5.7L GLi EFI	BPR6FS	050700	5.0L FL	RV15YC4	050928
5.7L GS 4 bbl	BR6FS	050831	5.0L Fi, Gi Gen 1+, GL Gen 1+	RS12YC	050949
5.7L GS, GSi Gen 1+	BPR6EFS	050857	5.7L Gi, GL, GLi, GS	RV15YC4	050928
5.7L GXi	TR55	050877	5.7L GS Gen 1+, GSi Gen 1+	RS12YC	050949
5.8L FL 4 bbl	UR4	050878	SERIES B/BB CONT.		
5.7L FSi EFI HO	BPR6EFS	050857	225, A, B, C, 231A	RV15YC4	050928
7.4L Gi EFI, Gi L29	BPR6EFS	050857	260, A, B, C, 261	RV15YC4	050928
7.4L GL 4 bbl	BR6FS	050831	SERIES C		
7.4L GSi EFI	BR6FS	050831	C5, C10, C23	RD16	051027
8.1L Gi/Gsi	TR4	050879	SERIES DPX		
8.1L GXi	TR55	050877	7.4L DPX 385	RV15YC4	050928
8.2L GSi EFI	BR6FS	050831	8.2L DPX 415	RV15YC4	050928
PJX Water Jet			SERIES DUOPROP		
4.3L Gi EFI	BPR6EFS	050857	4.3L GIPNCA	RV15YC4	050928
4.3L GS 4 bbl	BPR6EFS	050857	4.3L GIPNCS	RS12YC	050949
SX Cobra Grande			5.0L FL	RV15YC4	050928
3.0L GS 2 bbl	BPR6EFS	050857	5.0L Fi, 5.0L GL Gen 1+	RS12YC	050949
4.3L Gi EFI (.460 Rch.)	BPR6FS	050700	5.0L Gi GEN 1+	RS12YC	050949
4.3L Gi EFI (.708 Rch.)	BPR6EFS	050857	5.7L Gi, GL, GLi, GS	RV15YC4	050928
4.3L GL 2 bbl	BPR6EFS	050857	5.7L GS Gen 1+, GSi Gen 1+	RS12YC	050949
4.3L GS 4 bbl	BPR6EFS	050857	5.8L FL	RV15YC4	050928
5.0L Fi EFI	TR5	050708	5.8L FSi	RS9YC	050955
5.0L FL 2 bbl	UR4	050878	7.4L Gi, GL	RV15YC4	050928
5.0L Gi Gen 1+	BPR6EFS	050857	7.4L Gi L29	RS12YC	050949
5.0L GL Gen 1+	BPR6EFS	050857	7.4L GSi, 8.2L GSi	RV15YC4	050928
5.7L Gi EFI	BPR6FS	050700	SERIES ALTA CILINDRADA		
5.7L GL 2 bbl	BR6FS	050831	8.2L DPX 500, DPX 525	V63C	050946
5.7L GLi EFI	BPR6FS	050700	8.2L DPX 600	V63C	050946
5.7L GS 4 bbl	BR6FS	050831	SERIES M		
5.7L GS Gen 1+	BPR6EFS	050857	MB36A, MB36B	RJ12YC	050980

Bujías
VOLVO PENTA



VOLVO



POTENCIA HP	NGK STD.	Ref. PRONAUTIC	POTENCIA HP	CHAMPION	Ref. PRONAUTIC
5.7L GSi Gen 1+	BPR6EFS	050857	MB250S	P8Y	050964
5.7L GXi	TR55	050877	PZ-200	RV15YC4	050928
5.8L FL 4 bbl	UR4	050878	AQ60F, BB30F, MB18F	L90C	051028
5.8L FSi EFI HO	BPR6EFS	050857	SERIES SX Cobra CONT.		
7.4L Gi EFI	BPR6FS	050700	5.8L FL	RV15YC4	050928
7.4L Gi L29	BPR6EFS	050857	5.8L Fi, FSi	RS9YC	050955
7.4L GL 4 bbl	BR6FS	050831	7.4L GL, Gi	RV15YC4	050928
SERIES OCEAN			7.4L Gi L29	RS12YC	050949
4.3L OSi-XPd	TR5	050708	SERIES INTRABORDA Inboard		
5.0L OSi-XPd	TR5	050708	2002, 5.7L Gi	RV15YC4	050928
5.7L OSi-XPd	TR5	050708	2002, 5, 5.7L GSi, GXi	RS12YC	050949
5.7L OOXi-XPd	TR5	050708	5.8L FL/HS1	RV15YC4	050928
			5.8L FSi/HS1	RS9YC	050955
			7.4L GL, Gi/HS1	RV15YC4	050928
			7.4L Gi L29 STANDARD	RS12YC	050949
			7.4L Gi L29 PLATINUM	RS12PYP	050978
			2002, 8.1L Gi/GSi	RS15LYC	051029

TURBOS PARA MOTORES VOLVO

MODELO MOTOR VOLVO	REFERENCIA PRONAUTIC	REFERENCIA VOLVO
D4 225 A-B-C-AQ	VOL7700	3802150
D4 260	VOL7701	3582768
AD31 TAMd31 TMD31	VOL6094 o VOL6497	3802082
TAMd41 KAMd43 KAD42	6497	861220 - 3583006
MD40 TMD40 TAMd40 AQD40	6492	845294
KAMA300	VOL7200	3802125
KAD44 P-C	VOL7200	35830026

TURBOS VOLVO



HÉLICES BAEKSAN

Baeksan fabrica miles de hélices desde el año 1984. Nuestras hélices de altas prestaciones fabricadas con los mejores materiales aseguran una larga vida y una navegación tranquila y sin sobresaltos.

Sus palas compensadas ofrecen una reducción significativa de las vibraciones.

Cojinete de goma insertado en el núcleo en versión fija o núcleo intercambiable.

Mano de pintura de alto grosor para evitar la corrosión.

En caso de no conocer la referencia original de la hélice a reemplazar siga los siguientes pasos:

- 1-Comprueba el rango de Revoluciones por minuto (RPM) del fabricante del motor en el manual.
- 2-Comprueba las RPM máximas del motor leyendo el panel para determinar el paso y velocidad óptimo.
- 3-Si las RPM máximas exceden el rango recomendado, disminuye las RPM utilizando un paso superior.
- 4-Si las RPM son más bajas que el rango recomendado, aumenta las RPM utilizando un paso inferior.

Si no localiza la hélice que necesita contacte con nuestro departamento técnico.

VOLVO DUOPROP

Tipo	Transmisión	Referencia-Diam./Paso	OEM Part No.	Palas	Núcleo				
DUO	 <ul style="list-style-type: none"> • Aplicaciones diesel • Transmisiones DP 280, 290 <p>Hélice delantera - Tres palas Hélice trasera - Cuatro palas</p>	A3	6924279	854766	854776 854786	3 4	Fijo		
		A4	6924270	854767	854777 854787	3 4			
		A5	6924271	854768	854778 854788	3 4			
		A6	6924272	854769	854779 854789	3 4			
		A7	6924273	854770	854780 854790	3 4			
		B3	6924282	854816	854824 854832	3 3			
		B4	6924283	854817	854825 854833	3 3			
	 <ul style="list-style-type: none"> • Aplicaciones gasolina • Transmisiones DP 280, 290 <p>Hélice delantera - Tres palas Hélice trasera: tres palas</p>	B5	6924275	854818	854826 854834	3 3			
		B6	6924276	854819	854827 854835	3 3			
		B7	6924277	854820	854828 854836	3 3			
		SX	 <p>4-3/4" Caja de engranajes</p> <ul style="list-style-type: none"> • 3.0L 1994 y posteriores • 4.3L 1994 y posteriores • 5.0L 1994 y posteriores • 5.7L 1994 y posteriores • 5.8L 1994-1997 • 7.4L 1997 y posteriores • 8.2L 1997 <p>Escape a través del núcleo, 19 estrias</p>	62SX151213	15 1/2x13	3840720		3	Fijo
				62SX151215	15 1/2x15	3817466		3	
				62SX1517	15x17	3817467		3	
				62U150151415	15 1/4x15	48-78116A45		3	Interc. 62BH5X
62U1351517	15x17			48-832828A45	3				
62U150141219	14 1/2x19			48-832830A45	3				
62U150141421	14 1/4x21			48-832832A45	3				
62U1501423	14x23			48-832834A45	3				
624U1501516	15x16			48-834850A45	4				
624U150141218	14 1/2x18			48-834852A45	4				
624U1501420	14x20	48-834854A45	4						

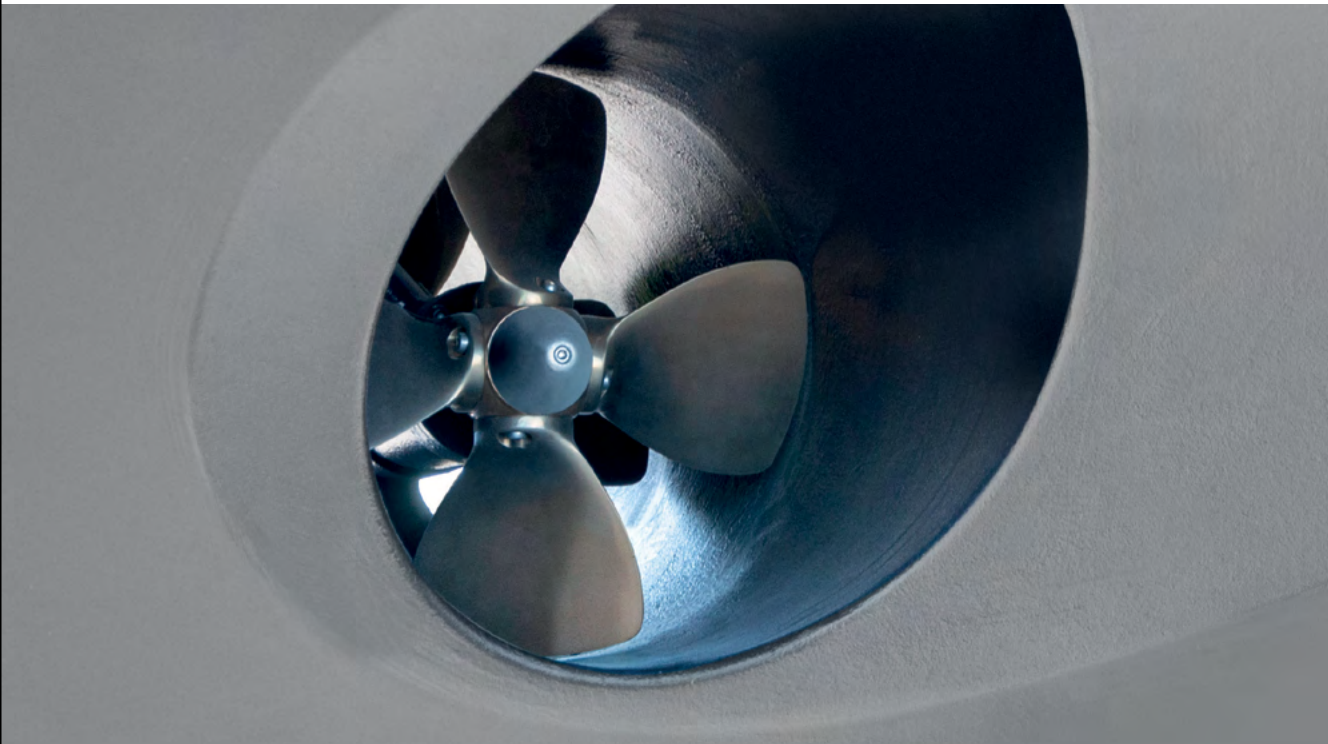

No se preocupe, a bordo tiene un Quick

Desde hace más de 30 años, los productos Quick son Made in Italy por la excelencia en el sector de los accesorios náuticos y sinónimo de fiabilidad para armadores y embarcaciones en todo el mundo.

Quick Nautical Equipment es una gama de productos que incluye sistemas de amarre y fondeo, sistemas de maniobra, una gama de energía, calentadores de agua y muchos accesorios más para controlar varias instalaciones a bordo.

| QUICK NAUTICAL EQUIPMENT | MC² QUICK GYRO | QNN - QUICK NAUTICAL NETWORK | QUICK MARINE LIGHTING |

Filtro Aceite

Tipo motor	Ref. Filtro
1GM 1 GM 10	11930535151
2 GM/ 2 GM 20/ 2 GM 20F	11930535151
3 GM/ 3 GM 30/ 3 GM 30F	11930535151
2QM 15	11930535151
2QM 20	11930535151
3QM 30	11930535151
3 HM	11930535151
3 HM 35	11930535151
3YM20/C	11930535151
3YM30/C	11930535151
3 JH2-E/BE	11930535151
3 JH2-CE/TCE	11930535151
3 JH2-TE / TBE	11930535151
3JH3-E / TCE	11930535151
3JH4 E/ CE	11930535151
4 JH E /TE /HTE /DTE	11966035150
4 JH2E /TE /HTE/ DTE/ UTE	11966035150
4 JH3 CE	11966035150
4 JH3-E-YEU	11966035150
4 JH3-TE-YEU	11966035150
4 JH3- HTE -YEU	11966035150
4 JH3-DTE-YEU	11966035150
4 JH4-E / CE	11966035150
4 JH4-TE /HTE	11966035150
4BY150/180	NO
4 LH - TE/HTE	11900535151
4 LH DTE/STE	12769535150
4 LHA-DTE /STE	12769535150
4 LHA-DTP /STP	12769535150
6 CX GTE / GTE2	12769535150
6BY220 /260	16500069590
6 LP-DTE /STE	11977090620
6 LPA-DTE / STE	11977090620
6 LPA-DTP / STP	11977090620
6 LY-UTE /STE /6LYA-STE	11959335100
6 LYA-STP / 6 LY2A-STE	11959335100
6 LY2A-STE /STP	11959335400

Filtro Gasoil

Tipo motor	Ref. Filtro
YSB 8/ YSB 12	10450055710
YSM 8 /YSM 12	10450055710
YSE 8 /YSE 12	10450055710
1GM 1 GM 10	10450055710
2 GM/ 2 GM 20/ 2 GM 20F	10450055710
3YM20 /C	10450055710
3 GM/ 3 GM 30/ 3 GM 30F	10450055710
2QM 15	10450055710
2QM 20	10450055710
3QM 30	10450055710
3 HM	10450055710
3YM30 /C	10450055710
3 HM 35	10450055710
3 JH2-E/BE	12947055703
3 JH2-CE/TCE	12947055703
3 JH2-TE / TBE	12947055703
3JH3-E/ TCE	12947055703
3JH4-E/ CE	12947055703
4 JH E/ TE/ HTE/ DTE	12947055703
4 JH2E /TE HTE/ DTE	12947055703
4 JH3 CE	12947055703
4 JH3-E-YEU	12947055703
4 JH3-DTE-YEU	12947055703
4 JH4E	12947055703
4 JH2 UTE	12957455711
4 JH3-TE-YEU	12957455711
4 JH3-HTE-YEU	12957455711
4 JH4-TE /HTE	12957455711
4BY150 /180 6BY220 /260	12065055040
4BY150 /180 6BY220 /260	12065055020
4 LH-TYE /HTE /HTTP	12185755710
4 LH DTE/STE	41650502320
4 LHA-DTE /STE	41650502320
4 LHA-DTP /STP	41650502320
6 LP-DTE /STE	11977355510
6 LPA-DTE /DTP /STE /STP	11977355510
6 LY-UTE /STE /STP	41650502330
6 LY-STE / STP	41650502330



18-6970
ALTERNADOR
Reemplaza: Yanmar 129470-77200
Para: series 2GM, 3HM & 4JM



18-6971
ALTERNADOR
Versión de alto amperaje 18-6970 (120A)



18-6849
ALTERNADOR
Reemplaza: Yanmar 119773-77200
Denso 101211-9940
Para: Motor Yanmar



18-6925
ALTERNADOR
Reemplaza: Yanmar 128270-77200
Hitachi LR135-105
Para: Motor Yanmar Marine 3GM



18-6926
ALTERNADOR
Reemplaza: Yanmar 119836-77200, -2, -3, 129612-77230
Para: 3TNE84 3 cil diesel, 3TNE88 3 cil diesel, 4TNE84 4cil, 1.995L, 4TNE88 4cil, 2.190L



18-6927
ALTERNADOR
Reemplaza: Yanmar 128171-77200
Para: Motores Yanmar GM



18-6928
ALTERNADOR
Reemplaza: Yanmar 128170-77200, 77201, 77202
Hitachi LR135-74, 74B
Para: modelos 3HM, 3HMF



18-6929
ALTERNADOR
Reemplaza: Yanmar 119573-77200, 77201, 129470-77200
Hitachi LR180-03A, B, C
Para: Motor Yanmar LH



18-6939
ARRANQUE
Reemplaza: Yanmar 121254-77010, 77011, 77012, 77019, 129429-77010, 77011



18-6880
ARRANQUE
3 Tornillos
Reemplaza: Yanmar 123500-77010, 124610-77010, -77019 424610-77010
Hitachi S114-257, 257G, 483, 483A



18-6930
ARRANQUE
Reemplaza: Yanmar 104211-77010, 77011



18-6931
ARRANQUE
Reemplaza: Yanmar 119209-77010, 121120-77010, 77011, 77012, 124520-77010, 77011
Para: Motores 3 TNV-84-T



18-6932
ARRANQUE
Reemplaza: Yanmar 121370-77010, 129242-77010, 129698-77010
Para: 2QM, 3JH3, 3JH3E, 3JH3E-YEU, 3QM, 3QM30, 3QM30F, 3QM30H, 4JH3E



18-6934
ARRANQUE
2 Tornillos
Reemplaza: Yanmar 129573-77010, 171008-77010
Hitachi S13-68, 68A, 68C, 86
Para: Modelo motor 2TR16, 2TR19



18-6935
ARRANQUE
Reemplaza: Yanmar 119225-77010, 77011, 119226-77010
Para: 3TN63, 3TN66, 3TN68



**18-6936
ARRANQUE**

Reemplaza: Yanmar 114361-77011,
114362-77010, 77011, 114399-77010
Para: L40S, L60S



**18-6937
ARRANQUE**

2 Tornillos
Reemplaza: Yanmar 128170-77010, 77010D
Hitachi S114-303, 303A
Para: GM, GM2, GM3, GM10, GM20/2-20F, GM30, GMF,
1GM, 2GM, 3GM



**18-6938
ARRANQUE**

Reemplaza: Yanmar 119773-77010
Para: Modelos diesel 6LP-DTE, 6LP-STE

YANMAR ALTERNADOR/APLICACIÓN ARRANQUE

Modelo	Año	Arranque	Alternador	Amps
1GM	1980-1984	18-6937	18-6925 ⑥	35
1GM	1980-1984	18-6937	18-6928 ③ ⑦ ⑧	35
1GM10	1980-1981	18-6937	18-6928	35
1GM10	1982-SUP	18-6937	18-6925 ④	35
1GM10	1982-SUP	18-6937	18-6927 ⑤	35
1GM10C	1982-1984	18-6937	18-6925	35
1GM10L	1982-SUP	—	18-6927 ⑤	35
1GM10L	1982-SUP	—	18-6925 ④	35
1GM10VE	1985-SUP	—	18-6927	35
1GML	1982-SUP	—	18-6927	35
1GML	1982-SUP	—	18-6925	35
1GMY	1982-SUP	—	18-6925 ④	35
1GMY	1982-SUP	—	18-6927 ⑤	35
2GM	1980-1984	18-6937	18-6925 ⑥	35
2GM	1980-1984	18-6937	18-6928 ③ ⑦ ⑧	35
2GM20	1982-SUP	18-6937	18-6925	35
2GMF	1980-1984	18-6937	18-6925 ⑥	35
2GMF	1980-1984	—	18-6928 ③ ⑦ ⑧	35
2GMFL	TODOS	—	18-6925	35
2GMFY(E)-E	TODOS	—	18-6925	35
2GML	TODOS	—	18-6925	35
2GMYE-EC	TODOS	—	18-6925	35
2GMZ	TODOS	—	18-6925	35
2QM15	1977-1980	—	18-6925 ⑥	35
2QM15	1977-1980	—	18-6928 ③ ⑦ ⑧	35
2QM20	1975-1980	—	18-6928	35
2TD	1982-SUP	—	18-6925	35
2TM	1982-SUP	—	18-6925	35
3GM	1980-1984	18-6937	18-6925	35
3GM	1980-1984	18-6937	18-6928 ③ ⑦ ⑧	35
3GMD	1982-SUP	18-6937	18-6925 ⑥	35
3GMD	1982-SUP	18-6937	18-6928 ③ ⑦ ⑧	35
3GMF	1982-SUP	18-6937	18-6925 ⑥	35
3GMF	1982-SUP	18-6937	18-6928 ③ ⑦ ⑧	35
3GMFY-E	1982-SUP	—	18-6925	35
3GMLE	1982-SUP	—	18-6927	35
3HM	1980-1984	—	18-6925 ⑥	35
3HM	1980-1984	—	18-6928 ③ ⑦ ⑧	35
3HMF	1980-1984	—	18-6925 ⑥	35

① Hitachi S114-303 ② Hitachi S114-483A ③ Hitachi LR135-105 ④ Hitachi LR135-126 ⑤ Hitachi LR135-74B ⑥ S/N 3690-inferior
⑦ S/N 3691-sup ⑧ Con 2 Pin conexión regulada ⑨ Sin 2 Pin conexión regulada ⑩ Sin tapa plástico

APLICACIONES CONTINUAN EN LA SIGUIENTE PÁGINA

YANMAR ALTERNADOR/APLICACIÓN ARRANQUE

Modelo	Año	Arranque	Alternador	Amps
3HMF	1980-1984	—	18-6925 ③ ⑦ ⑧	35
3JH2	1991-1999	18-6880	18-6925	35
3JH2	1991-1999	18-6880	18-6929	80
3JH2BE	1991-1999	18-6880	18-6929	80
3JH2E	1991-1999	18-6880	18-6929	80
3JH3	1999-2003	—	18-6925	35
3JH3	1999-2003	—	18-6929	80
3JH3E	TODOS	—	18-6929	80
3JH3E-YEU	TODOS	18-6880	—	—
3JH3Z	TODOS	—	18-6925	35
3JH4E	2003-SUP	—	18-6929	80
3TM20	2004-SUP	—	18-6929	80
3YM30	2004-SUP	—	18-6929	80
3TN63	1990-SUP	18-6935	—	—
3TN66	1985-SUP	18-6935	—	—
3TN68	1995-SUP	18-6935	—	—
3TNE84	1982-SUP	18-6880	18-6926	40
3TNE88	1982-SUP	18-6880	18-6926	40
3TNV-84-T	TODOS	18-6931	—	—
4GM	1985-SUP	—	18-6925	35
4JH	1982-SUP	18-6880	18-6925	35
4JH2-CE	1988-SUP	18-6880	18-6929	80
4JH2-DTE	1988-SUP	18-6880	18-6929	80
4JH2-E	1988-SUP	18-6880	18-6929	80
4JH2-HTE	1988-SUP	18-6880	18-6929	80
4JH2L-HTNE	1988-SUP	18-6880	18-6925	35
4JH2L-TNE	1988-SUP	18-6880	18-6925	35
4JH2-TE	1988-SUP	18-6880	18-6929	80
4JH2-UTE	1988-SUP	18-6880	18-6925	35
4JH3-CE	1994-2003	18-6880	18-6929	80
4JH3-DTE	1994-2003	18-6880	18-6929	80
4JH3E	1994-2003	18-6880	18-6929	80
4JH3-HTE	1994-2003	18-6880	18-6929	80
4JH3-TCE	1994-2003	18-6880	18-6929	80
4JH3-TE	1994-2003	18-6880	18-6929	80
4JH3-TE-YEU	1994-2003	18-6880	—	—
4JH3ZA	1994-2003	18-6880	18-6925	35
4JHE	TODOS	—	18-6929	80
4JH-HT	1982-SUP	—	18-6925	35
4JH-HT-Z	1982-SUP	18-6880	18-6925	35
4JH-T	1982-SUP	18-6880	18-6925	35
4JH-TE	1982-SUP	—	18-6929	80
4JH-TZ	1982-SUP	18-6880	18-6925	35
4JHZ	TODOS	18-6880	18-6925	35
4LHA-DTE	TODOS	18-6939	18-6929	80
4LHA-DTZ	TODOS	18-6939	18-6929	80
4LHA-HTE	TODOS	18-6939	18-6929	80
4LHA-HTZE	TODOS	18-6939	18-6929	80
4LHA-STE	TODOS	18-6939	18-6929	80
4LHA-STZE	TODOS	18-6939	18-6929	80
4LH-DTE	1987-SUP	18-6939	18-6929	80

● Hitachi S114-303 ● Hitachi S114-483A ① Hitachi LR135-105 ② Hitachi LR135-126 ③ Hitachi LR135-74B ④ S/N 3690-inferior
 ⑤ S/N 3691-sup ⑥ con 2 Pin conexión regulada ⑦ sin 2 Pin conexión regulada ⑧ Sin tapa de plástico

APLICACIONES CONTINUAN EN LA SIGUIENTE PÁGINA

YANMAR ALTERNADOR/APLICACIÓN ARRANQUE

Modelo	Año	Arranque	Alternador	Amps
4LH-HTE	1987-SUP	18-6939	18-6929	80
4LH-STE	1987-SUP	18-6939	18-6929	80
4LH-TE	TODOS	18-6939	18-6929	80
4TD	1982-SUP	—	18-6925	35
4TM	1982-SUP	—	18-6925	35
4TNE84	1989-SUP	18-6880	18-6926	40
4TNE88	1989-SUP	18-6880	18-6926	40
6LP-DT	1997-SUP	—	18-6849	80
6LP-DTE	1997-SUP	18-6938	18-6849	80
6LP-DTZE	1997-SUP	—	18-6849	80
6LP-DTZE1	1997-SUP	—	18-6849	80
6LP-DTZY	1997-SUP	—	18-6849	80
6LP-ST	1997-SUP	—	18-6849	80
6LP-STE	1997-SUP	18-6938	18-6849	80
6LP-STZE	1997-SUP	—	18-6849	80
6LY2-STE	1992-SUP	18-6934	18-6929	80
6LYA-STE	1992-SUP	18-6934	18-6929	80
6LYA-UTE	1992-SUP	18-6934	18-6929	80
6LYM-STE	1992-SUP	18-6934	18-6929	80
6LYM-UTE	1992-SUP	18-6934	18-6929	80
6LY-ST	1992-SUP	18-6934	18-6929	80
6LY-STE	1992-SUP	18-6934	18-6929	80
6LY-STM	1992-SUP	18-6934	18-6929	80
6LY-STZY	1992-SUP	18-6934	18-6929	80
6LY-UT	1992-SUP	18-6934	18-6929	80
6LY-UTE	1992-SUP	18-6934	18-6929	80
6LY-UTM	1992-SUP	18-6934	18-6929	80
6LY-UTZY	1992-SUP	18-6934	18-6929	80
KBW-20	TODOS	—	18-6929	80
KBW-21	TODOS	—	18-6929	80
6PH	1982-SUP	18-6934	—	—
6PH-HTZY	1982-SUP	18-6934	—	—
6PH-M-HTE	1982-SUP	18-6934	—	—
6PHM-HTZ	1982-SUP	18-6934	—	—
6PHM-TZ	1982-SUP	18-6934	—	—
6PHS-HTPS	1982-SUP	18-6934	—	—
6PHS-TPS	1982-SUP	18-6934	—	—
KM2A	TODOS	18-6937	18-6925 ①	35
KM2A	TODOS	18-6937	18-6927 ②	35
KM2C	TODOS	18-6937	—	—
KM2P	TODOS	18-6937	18-6925 ①	35
KM2P	TODOS	18-6937	18-6927 ②	35
KM3A	TODOS	18-6937 ①	18-6929	80
KM3A	TODOS	18-6880 ②	18-6929	80
KM3P	TODOS	18-6937	—	—
KM3V	TODOS	18-6937	18-6925 ①	35
KM3V	TODOS	18-6937	18-6927 ②	35
KM5A	TODOS	18-6939	18-6929	80
L40S	1984-1999	18-6936	—	—
L60S	1984-1999	18-6936	—	—
SB12	1976-1980	18-6930	—	—

① Hitachi S114-303 ② Hitachi S114-483A ③ Hitachi LR135-105 ④ Hitachi LR135-126 ⑤ Hitachi LR135-74B ⑥ S/N 3690-inferior
 ⑦ S/N 3691-sup ⑧ Con 2 Pin conexión regulada ⑨ Sin 2 Pin conexión regulada ⑩ Sin plástico tapa

APLICACIONES CONTINUAN EN LA SIGUIENTE PÁGINA

YANMAR ALTERNADOR/APLICACIÓN ARRANQUE

Modelo	Año	Arranque	Alternador	Amps
SB8	1976-1980	18-6930	—	—
SVE12	1974-1976	18-6930	—	—
SVE8	1974-1976	18-6930	—	—
UJH2E	TODOS	18-6880	18-6929	80
Y-5M	TODOS	—	18-6925 ①	35
Y-5M	TODOS	—	18-6927 ②	35
YC	1971-SUP	18-6930	—	—
YSB12	1976-1977	18-6930	—	—
YSB8	1976-1977	18-6930	—	—
YSE12	1974-1976	18-6930	—	—
YSE8	1974-1976	18-6930	—	—
YSM12	1977-1980	18-6930	—	—
YSM8	1977-1980	18-6930	—	—

● Hitachi S114-303 ② Hitachi S114-483A ① Hitachi LR135-105 ② Hitachi LR135-126 ③ Hitachi LR135-74B ④ S/N 3690-inferior
 ⑤ S/N 3691-sup ⑥ Con 2 Pin conexión regulada ⑦ Sin 2 Pin conexión regulada ⑧ Sin plástico tapa

DIESEL FILTRO COMBUSTIBLE

20 MICRONES



18-7931
Reemplaza:
 Detroit Diesel 5574508
 8V-92, 8V-71

20 MICRONES



18-7934
Reemplaza:
 Cerlist Diesel 1512904
 Modelo M

20 MICRONES



18-7935
Reemplaza:
 Fram CCS 1136
 Fram FCS 1136 soporte filtro

18-79960
ELEMENTO FILTRO COMBUSTIBLE

Reemplaza: Yanmar 104500-55710
Para: Todas series GM, series YM, HM Series, QM Series



20 MICRON



18-7970
Reemplaza:
 Cerlist Diesel 1512903
 Modelo 3M



18-57703
FILTRO AIRE
Reemplaza:
 Yanmar 128270-12540
Para: Yanmar 2GM & 3GM30



18-57704
FILTRO AIRE
Reemplaza:
 Yanmar 128171-12540
Para: Yanmar 1GM10



18-8950
IMPULSOR
Reemplaza:
 Yanmar 124223-42092
Para: 2GM20F, 2GMF, 2QM, 2QM20,
 3GM30F, 3GMF, 3HM, 3HM35, 3HM35F,
 3HMF, 3QM30, 3QM30F



18-8951
IMPULSOR
Reemplaza:
 Yanmar 128176-42071
Para: 1GM, 1GM10



18-8952
IMPULSOR
Reemplaza:
 Yanmar 104211-42071
Para: 2GM, 3GM



Sistema combustible
YANMAR

RESTO DE ANODOS en la pág. 360

18-6200
ANODO
Reemplaza:
Yanmar 27210-200200
Para: 1GM, 1GM10, 6LY3



18-6201
ANODO
Reemplaza:
Yanmar 27210-200300
Para: 2GM, 3GM, 2GMF, 3GMF, 2GM20, 3GM30,
3HM, 3HM35, 2QM15, 2QM, 3QM, 2QM20, 3QM30,
YSB8, YSB12, YSM8, YSM12



18-55601
JUNTA CULATA
Reemplaza:
Yanmar 128171-01911
Para: 1GM10 (9hp)



18-55602
JUNTA CULATA
Reemplaza:
Yanmar 128271-01911
Para: 2GM20 (18hp), 2GM20B,
2GM20C, 2GM20F (18hp)



18-55603
JUNTA CULATA
Reemplaza:
Yanmar 128374-01911
Para: 3GM30 (27hp), 3GM30 EU
(27hp), 3GM30F (27hp), 3GM30F
EU (27hp)



18-45714
IMPULSOR F75B
Reemplaza:
Yanmar 119574-42550,
119574-42552
Para: bomba F75B



18-55500
JUNTA CULATA
Reemplaza:
Yanmar 728170-92600
Para: 1GM (7hp)



18-55501
JUNTA CULATA
Reemplaza: Yanmar 18-55501
Para: 1GM10 (9hp)

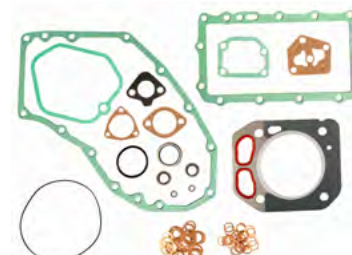

18-55502
JUNTA CULATA
Reemplaza:
Yanmar 728271-92605
Para: 2GM20 (18hp), 2GM20B, 2GM20C,
2GM20F (18hp)

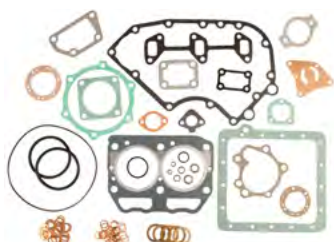

18-55503
JUNTA CULATA
Reemplaza:
Yanmar 728374-92605
Para: 3GM30 (27hp), 3GM30 EU (27hp),
3GM30F (27hp), 3GM30F EU (27hp)



18-56000
JUNTA TAPA BONNET
Reemplaza:
Yanmar 128170-11310
Para: 1GM, 1GM10



18-56601
JUNTA TERMOSTATO
Reemplaza:
Yanmar 104211-49160
Para: 1GM, 1GM10



18-56602
JUNTA BOMBA AGUA
Reemplaza:
Yanmar 128170-42090
Para: 1GM, 1GM10



18-55600
JUNTA CULATA
Reemplaza:
Yanmar 128170-01331
Para: 1GM (7hp)



FILTRO ACEITE

Los filtros de aceite SIERRA están fabricados con materiales de alta calidad:

- Capa de epoxy de gran resistencia a la corrosión.
- Recipiente de acero extra-resistente.
- Elemento filtrante de alta eficiencia.
- Cubierta por la garantía Sierra.



***18-7910-1**
Reemplaza:
 Westerbeke 30220
 Yanmar 124450-35100, 119350-35150,
 119350-35151
 Rosca Espec: 20mm x 1.5



***18-7917**
Reemplaza:
 Yanmar 124450-35110, 124550-35110,
 171056-35110, 171056-35111, 124085-35113
 Rosca Espec: 20mm x 1.5



***18-7925**
Reemplaza:
 Westerbeke 21235
 Rosca Espec: 3/4" x 16NPT



***18-7926**
Reemplaza:
 Volvo 423135, 4785974
 Rosca Espec: 1" x 12NPT



***18-7886**
Reemplaza:
 Perkins 2654403
 Rosca Espec: 3/4" x 16NPT



18-7927
Reemplaza:
 Caterpillar 1R-0714
 Rosca Espec: 1 1/8" x 16NPT

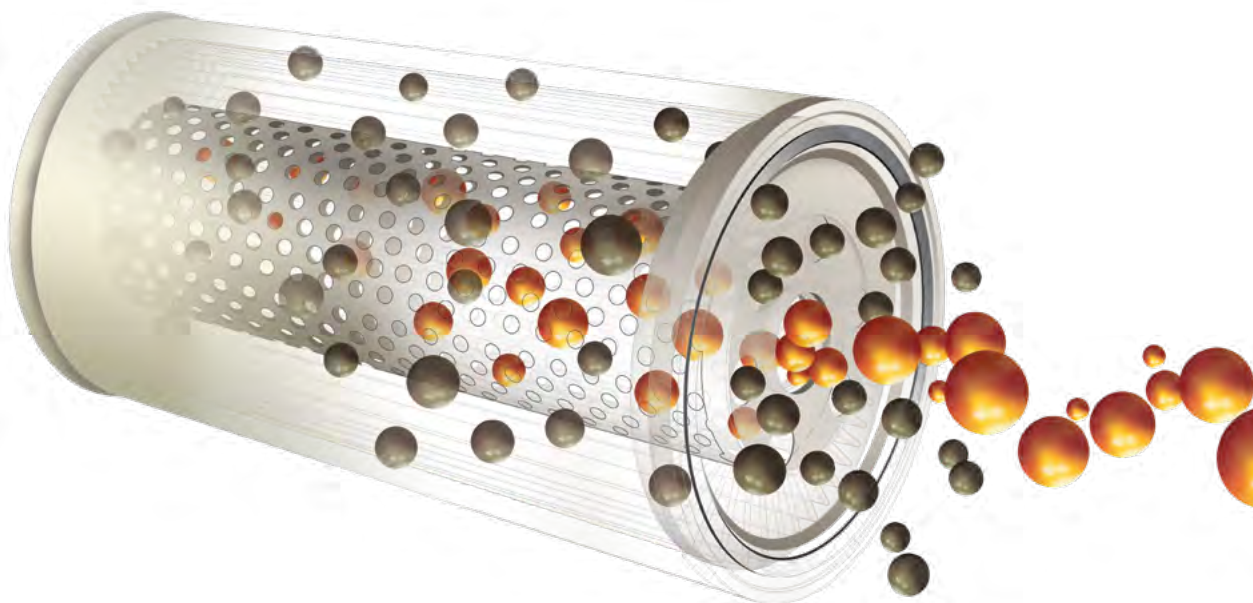

* Anti-Drenaje-Válvula de retroceso
 Elimina los arranques en seco, la válvula evita que el aceite vuelva al cárter durante el apagado del motor.

ÁNODOS YANMAR

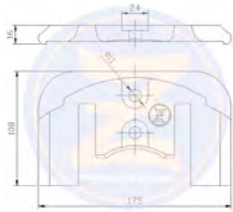

025298

Zn 0,985

Yanmar
 Ánodo para Cola Yanmar ZZT350-ZT370
 #OEM 196350-02350

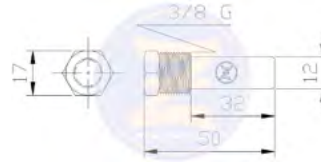

11977392600

Zn 0,064

Yanmar
 Ánodo cabeza de latón rosca 3/8 G Cónica (BSPT) para Yanmar 6LP/6LY/4LH. #OEM 119574-44150

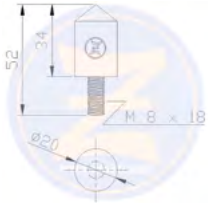

025338

Zn 0,068

Yanmar
 Ánodo para sistema de refrigeración de motores Yanmar

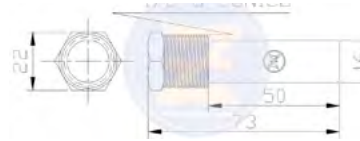

11957418790

Zn 0,145

Yanmar
 Ánodo cabeza de latón 1/2 Gas Cónica (BSPT) para refrigerador motores Yanmar 6LP/6LY/4LH. #OEM 119574-18790

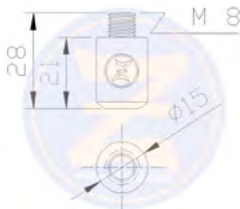

025289

Zn 0,023

Yanmar.
 Ánodo sistema de refrigeración motores Yanmar 4BY/6BY, rosca M 8. #OEM 120650-13420



025410

Zn 0,1

Yanmar
 Recambio ánodo de zinc referencia Z-5433. Solo Zinc. #OEM 119574-18790

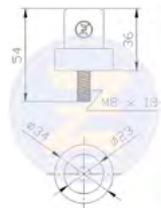

025336

Zn 0,152

Yanmar
 Ánodo recambio para sistema de refrigeración de Yanmar SB8, SB12, YSE8, YSE 12, YSB8, YSB12. #OEM 104211-41300



025453

Zn 0,142

Yanmar
 Ánodo para sistemas de refrigeración de motores Yanmar SD20/SD25/SD30/SD31, 4LH-STE y 6LY-UTE Series. #OEM 177301-54900 / #OEM 27210-200550

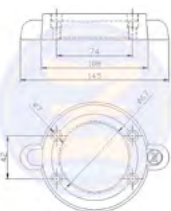

25898

Zn 0,835

Yanmar
 Ánodo collar para hélices Saildrive Yanmar SD20, SD30, SD31, SD40, SD50. #OEM 196420-02652

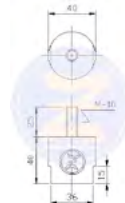

025963

Zn 0,354

Yanmar
 Perno para Yanmar diam. 40*40MM RM-10*25MM. #OEM 27200-400400

MODELO MOTOR	REFERENCIA PRONAUTIC	REFERENCIA YANMAR
4LH-STE	MYAV	119195-18031
4LH-DTE	6292	119173-18010
4LHA-DTE	MYDH o MTDN	119173-18401
4LHA-STE	MYDA	119175-18030
3JH2-TE	MYBA	129171-18001
4JH3-HTE	MYCY	129672-18001
4JH3-TE	MYCZ	129671-18001
4LH-TE	MY58	119171-18010
4JH-DTE	MY34	129473-1800
6LP-DTE	MYAX	119773-18010
6LY2-STE	MYAW	119575-18010
6LYA-STE	MYDW	119574-18020
6LPA-STP2	MYEV	119775-18150



18-35436
BOMBA COMBUSTIBLE ELÉCTRICA
 Universal - 12V 5-9 psi @ 16.8 gph 1/8"
 Tubo con rosca hembra



18-7627
COLECTOR ADMISIÓN
 Bloques pequeños GM con culata vortec.



18-7628
COLECTOR ADMISIÓN
 Bloques pequeños GM con culata Vortec y circuito cerrado para agua salada



18-7489
CARBURADOR WEBER 750

- Cuadrada
- Pulido
- Estrangulador eléctrico
- Calibrado y testado para un alto rendimiento.



18-1989
TERMOSTATO ALOJAMIENTO
 Reemplaza: 8M0061381, 861006A1
 Acero inoxidable
 Use 18-1989K kit servicio termostato para reemplazar partes



18-1989K
KIT SERVICIO TERMOSTATO
 kit servicio para 18-1989 termostato aloj.



18-4487
COLECTOR ADMISIÓN, HIERRO FUNDIDO
 Para: Bloques pequeños GM, 1987-1995.



18-4488
COLECTOR ADMISIÓN, HIERRO FUND.
 Para: Bloques pequeños GM, vortec



18-4506
PLACAS GUÍA
 Bloque grande GM con 5/16" varilla de empuje



18-4508
KIT TORNILLERIA
 Kit de tornillos de alto rendimiento de bloque peq. GM





18-4492

CONJUNTO BALANCIN

Reemplaza: Mercruiser 35329, F3746241, FI1100014, FI1100495
 Para: MCM/MIE Gm V6 & V8(283, 305 & 350 cid)



18-4507

KIT BALANCINES (4 VÁLVULAS)

Bloque grande GM

CONJUNTO CULATA

*Todas las culatas son nuevas y montadas con válvulas de acero inoxidable, asientos de válvula, muelles de válvula, semi-conos y retenes.
 Todas las culatas GM utilizan esparragos de alto rendimiento en lugar de los originales.*



18-4485

CULATA

Reemplaza: MerCruiser 938-883490R1, 938-883490, 938-883490R50, 938-884741R, 938-884741R50
 Para: 5.7L V-8 GM (1987-95) con 12 pernos en el colector de admisión.
 Tornillos de fijación (4 dentro de los pernos del colector de admisión a 23 grados), tapas de válvula de montaje central



18-4485HP
CULATA

Para: Medio GM bloque pequeño 5.7L alto rendimiento.
 Completamente montado con deslizadera revisada y cámaras de combustión. Agregar 30hp para balance de motor sin modificaciones adicionales.



18-4486

CULATA

Reemplaza: MerCruiser 938-883297 1, 938-803860T, 938-883297R1
 Para: 5.7L V-8 GM Vortec (1996-Sup) con 8 tornillos en el colector de entrada.



18-4486HP
CULATA

Para: Vortec GM pequeño bloque 5.7L alto rendimiento
 Completamente montado con deslizadera revisada y cámaras de combustión. Agregar 30hp para balance de motor sin modificaciones adicionales.



18-4489

CULATA

Reemplaza: MerCruiser 936-810840/986767, 938-884739R01
 Para: 2.5L/3.0L GM (1968-95) (no MerCruiser LX modelos) (1968-95)



18-4484HP
CULATA

Para: Rapido GM bloque pequeño 5.7L alto rendimiento
 Completamente montado con deslizadera revisada y cámaras de combustión. Agregar 30hp para balance de motor sin modificaciones.





**18-4493HP
CULATA**

Para: bloque grande GM
Rendimiento hierro fundido



**18-4491
CULATA**

Reemplaza: MerCruiser 938-827178
Reemplaza 4.3L Vortec V-6 (1996-sup) con tornillo en los espárragos del brazo (válvula no ajustable), colector de admisión con 8 tornillos, tapa válvula centrada. NOTA: No utilizar con motores con balancines de fábrica.



**18-4501
CULATA**

Para: 5.0L Vortec



**18-4501HP
CULATA**

Para: Vortec GM bloques pequeños 5.0L
Camisas y cámaras de combustión revisados.
Añada 30 hp al motor sin modificaciones.



**18-4497
TAPA DISTRIBUCIÓN**

Para: bloques pequeños GM-(1986-1995)



**18-56870
TAPA DISTRIBUCIÓN**

Reemplaza: Mercury 59341A1
Para: GM 3.0L con tapa metálica



**18-4511
TAPA DISTRIBUCIÓN**

GM 4.3L- Compuesto con sensor a babor
Incluye junta & front seal.



**18-4512
TAPA DISTRIBUCIÓN**

GM 4.3L Compuesto sin sensor a babor
Incluye junta & retén frontal.



**18-4513
TAPA DISTRIBUCIÓN**

GM 5.0L/5.7L- Compuesto con puerto sensor incluye junta y retén frontal.



**18-4514
TAPA DISTRIBUCIÓN**

GM 5.0L/5.7L- Compuesto con sensor a babor incluye junta y retén frontal.



**18-4516
ARO ENGRANAJE-VOLANTE**

14" GM volante con 168 dientes



**18-4517
ARO ENGRANAJE-VOLANTE**

12" GM volante con 153 dientes



**18-4518
VOLANTE**

14" 4.3L V-6, 1 Pieza principal y hasta 1987. Montaje inferior montado en el bloque de arranque (aplicación)



**18-4519
VOLANTE**

14" 5.0/5.7L, 1 Pieza principal y hasta 1987. Montaje inferior montado en el bloque de arranque (aplicación).



**18-4521
VOLANTE**

14" bloque pequeño GM, 2 Pieza principal, antes de 1987. Montaje inferior montado en el bloque de arranque (aplicaciones).



**18-4522
VOLANTE**

14" 454, Gen IV con 2 Pieza principal, antes de 1987. Montaje inferior montado en el bloque de arranque (aplicaciones).



18-4523
VOLANTE
14" 454, Gen V & VI con 1 Pieza principal, antes de 1987. Montaje inferior montado en el bloque de arranque (aplicaciones)..



18-4726
VÁLVULA RETÉN
Para: GM V-6 & V-8



18-4727
VÁLVULA MUELLE
Para: GM vortec válvula muelle estilo



18-4728
VÁLVULA MUELLE
Para: GM standard válvula muelle estilo



18-4729
VÁLVULA RETENEDORA, VORTEC
Para: GM V-6 & V-8



18-4730
VÁLVULA RETENEDORA
Para: GM V-6 & V-8



18-4731
BLOQUEO DE VÁLVULA
Para: GM V-6 & V-8



18-4732
VÁLVULA ADMISIÓN (1.94")
Para: GM V-6 & V-8



18-4733
VÁLVULA ESCAPE (1.50")
Para: GM V-6 & V-8



18-4734
VÁLVULA ADMISIÓN (1.84")
Para: GM V-6 & V-8



18-4735
VÁLVULA ADMISIÓN (2.02")
Para: GM V-6 & V-8



18-4736
VÁLVULA ESCAPE (1.60")
Para: GM V-6 & V-8



18-4737
TORNILLO
Para: GM motores V-6 & V-8



18-8962
CONJUNTO TAPA VÁLVULA
Para: 4.3L V-6 (1986 & sup) metal



18-8963
CONJUNTO TAPA VÁLVULA
Para: bloque pequeño GM (1986 & sup)



KIT TAPONES BRONCE
Elimina la posible oxidación. El kit incluye todos los tapones necesarios para un motor.

18-56481
KIT TAPONES BRONCE
Chevrolet 265-400

EDELBROCK® CARBURADORES

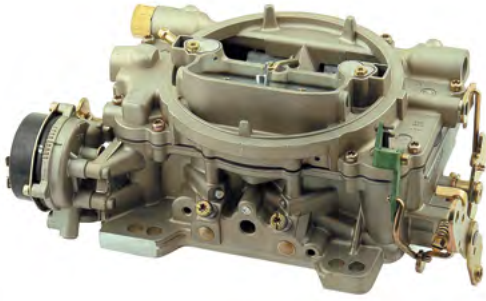

18-34080
CARBURADOR 600 CFM
Para: V-6 y pequeño V-8



18-34081
CARBURADOR 750 CFM
Para: Bloque grande y pequeño GM



EDELBROCK® COLECTORES DE ADMISIÓN

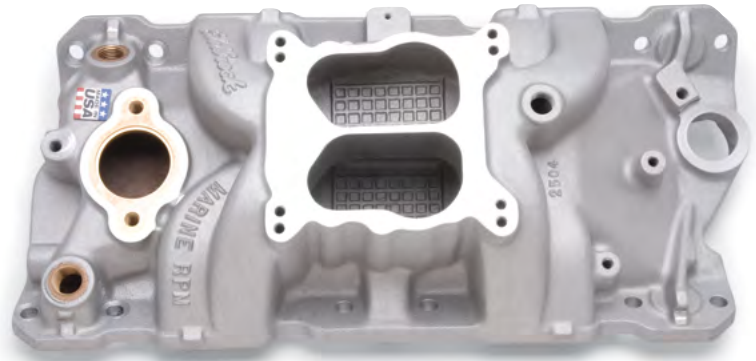

18-34082
COLECTOR DE ADMISIÓN DE AGUA
Para: Bloque pequeño GM, 1955-1986

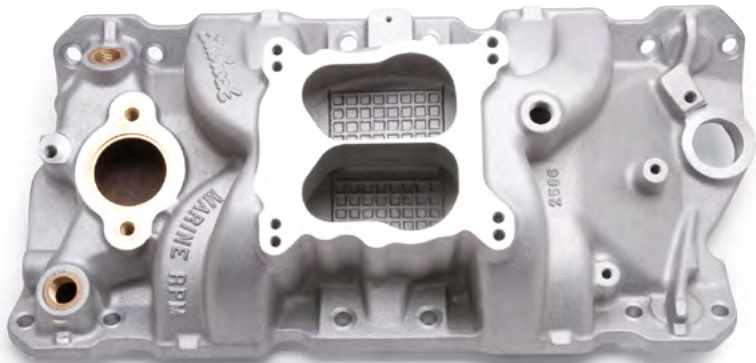

18-34083
COLECTOR DE ADMISIÓN DE AGUA
Para: Bloque pequeño GM, 1987-1995

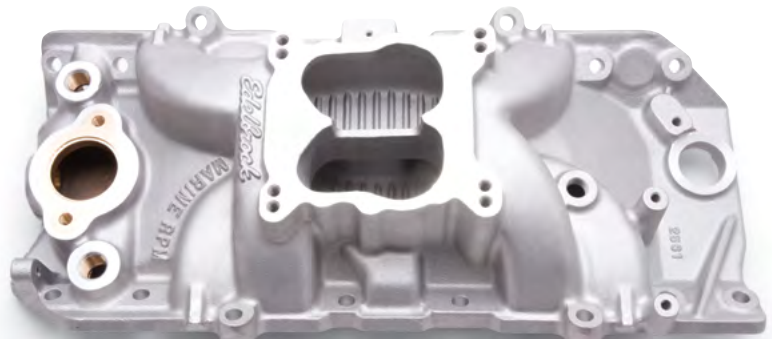

18-34084
COLECTOR DE ADMISIÓN DE AGUA
Para: Bloque grande GM

FORD V-8 302/5.0L 1977-93

18-1273 ②

JUEGO JUNTA CULATA
— CONTIENE —

Descripción	Ref #
Junta culata (2)	18-3883
Junta montaje carb. 4BBL	18-0357
Junta montaje carb. 2BBL	18-0360
Kits juntas colector admisión	18-0410
Junta tapa válvula (2)	18-0352
Retenes válvula (16)	18-4023

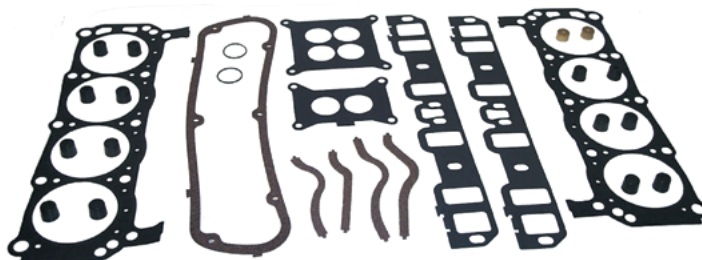

FORD V-8 351/5.8L 1977-93

18-1273 ②

JUEGO JUNTA CULATA
— CONTIENE —

Descripción	Ref #
Junta culata (2)	18-3883
Junta montaje carb. 4BBL	18-0357
Junta montaje carb. 2BBL	18-0360
Kits juntas colector admisión	18-0410
Junta tapa válvula (2)	18-0352
Retenes válvula (16)	18-4023

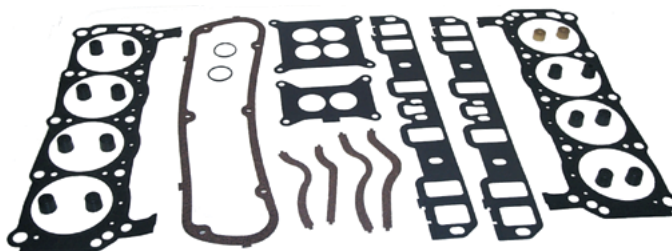

① No incluye junta carter

② No incluye juntas colector admisión/escape

NSS No se vende por separado

APLICACIONES KITS DE JUNTAS

Motor/Modelo	Años	Núm.serie	Bloque corto	Kit de juntas
Chevy 153-2.5L	1965-85	3377341-6229717 ⑤ ②	18-1271	18-1274
Chevy 153/2.5L	1986-88	6229718 & Sup ⑤ ②	18-1271	18-1274
Chevy 181/3.0L	1973-84	3332137-6229717 ⑤ ② ⑤	18-1271	18-1274
Chevy 181/3.0L	1985-96	6229718 & Post ⑤ ② ⑤	N/D	18-1274
Chevy 181/3.0LX	1990-97	C856559 & Post ① ⑤ ②	N/D	18-1274
Mercuriser 165/3.7L (4 Cil.)	1987-89	6916779 & Post ⑦ ③	18-1276	18-1277
Mercuriser 170 (4 Cil.)	1985-86	6916779 & Post ③	18-1276	18-1277
Mercuriser 180/3.7L-LX (4 Cil.)	1987-89	6916779 & Post ③	18-1276	18-1277
Mercuriser 190 (4 Cil.)	1985-86	6916779 & Post ③	18-1276	18-1277
Mercuriser 470	1976-82	4208730-6218036 ③	18-1276	18-1277
Mercuriser 470	1983-84	6218037-6916778 ③	18-1276	18-1277
Mercuriser 485	1980-82	5685394-6218036 ③	18-1276	18-1277
Mercuriser 488	1983-84	6170297-6916778 ③	18-1276	18-1277
Chevy 229/3.8L	1983-84	6330183-6919655 ② ⑤	18-1270	18-1275
Chevy L6 250/4.1L	1970-81	2770032-5813433 ⑤	18-1255	18-1264
Chevy 262/4.3L (2Pc. Rm Retén)	1985	6919656-B455459 ⑤	N/D	18-1275
Chevy 262/4.3L (2Pc. Rm Retén)	1986-92	A483581 ① ⑤	18-1270	18-1275

① Parte trasera cigüeñal de una sola pieza.

② Modelos 3.8L requiere 18-1211 Retén trasero cigüeñal y 18-0362 Junta carter

③ Modelos starboard dip stick requieren 18-0411 Kit juntas carter

④ Juego de 4 piezas

⑤ Incluye juntas de culata y de válvula

⑦ Juntas colector escape/admisión incluidas en el kit

⑧ Se requiere cigüeñal trasero principal

① Se requiere juntas cigüeñal

② Modelos varilla de empuje requieren 18-0328

③ Kit bloque corto no incluye juntas cigüeñal

④ Use 18-4349 para num. de serie 6218462-B525981

⑤ Para modelos con un único retén trasero cigüeñal use 18-1206 kit

APLICACIONES KITS DE JUNTAS

Motor/Modelo	Años	Núm.serie	Bloque corto	Kit de juntas
Chevy 262/4.3L Gen II	1992	D714370-F802999 ① ⑤	18-1270	18-1278
Chevy 262/4.3L Gen II	1993-96	D714370-F802999 ① ⑤	18-1270	18-1278
Chevy 305/5.0L	1977-85	4762210-B525981 ③ ⑤	18-1265	18-1266
Chevy 305/5.0L (Rev. Rota.)	1977-85	4762210-B525981 ③ ⑤	—	18-1266
Chevy 305/5.0L (1 Pc. Rm Retén)	1986	A482027-B525981 ① ⑤	18-1258	18-1266
Chevy 305/5.0L (Rev. Rota.) (1 Pc. Rm Retén)	1986	A482027-B525981 ① ⑤	18-1263	18-1266
Chevy 305/5.0L	1987-95	B525982 & Post ① ⑤ ⑧	18-1268	18-1267
Chevy 305/5.0L Intraborda	1987-95	B522506 & Post ① ⑤ ⑧	18-1268	18-1267
Chevy 305/5.0L (Rev.Rota) intraborda	1987-95	B522506 & Post ① ⑤	18-1263	18-1267
Chevy 350/5.7L	1975-86	4175500-B525982 ③ ⑤ ④	18-1265	18-1266
Chevy 350/5.7 Intraborda	1975-86	4498701-B522506 ③ ⑤	18-1265	18-1266
Chevy 350/5.7 (Rev.Rota) Intraborda	1975-86	4498701-B522506 ③ ⑤	—	18-1266
Chevy 350/5.7L (1Pc. Rm Retén)	1986	6218462-B522506 ① ⑤	18-1268	18-1266
Chevy 350/5.7L (1Pc. Rm Retén) Intraborda	1986	A492879-B522506 ① ⑤	18-1268	18-1266
Chevy 350/5.7L (Rev.Rota)(1 Pc. Rm Retén)	1986	A492879-B522506 ① ⑤	18-1263	18-1266
Chevy 350/5.7L	1987-95	B525982 & Post ① ⑤ ⑧	18-1268	18-1267
Chevy 350/5.7L	1996-97	B525982 & Post ① ⑤ ⑧	18-1268	18-1267
Chevy 350/5.7L Intraborda	1987-95	B522506 & Post ① ⑤	18-1263	18-1267
Chevy 350/5.7L Intraborda	1996-97	B522506 & Post ① ⑤	18-1263	18-1267
Chevy 350/5.7L (Rev.Rota.) Intraborda	1987-95	B522506 & Post ① ⑤	18-1263	18-1267
Chevy 350/5.7L (Rev. Rota.) Intraborda	1996-97	B522506 & Post ① ⑤	18-1263	18-1267
Chevy 454/7.4L	1977-92	4623115-D937001 ⑤	18-1256	18-1257
Chevy 454/7.4L Intraborda	1977-92	4623110 & Post ⑤	18-1256	18-1257
Chevy 454/7.4L (Rev.Rota.) Intraborda	1977-92	4623110 & Post ⑤ ⑧	18-1256	18-1257
Chevy 454/7.4L (Sq. Ports)	1988-91	B721206-D805068 ⑤	18-1256	18-1259
Chevy 454/7.4L Gen V	1992-94	D603118 & post ⑤	18-1261	18-1258
Chevy 454/7.4L Gen V	1995-97	D603118 & Post ⑤	18-1261	18-1258
Chevy 454/7.4L Gen V Intraborda	1992-94	D715494 & Post ⑤	18-1261	18-1258
Chevy 454/7.4L Gen V Intraborda	1995-97	D715494 & Post ⑤	18-1261	18-1258
Chevy 454/7.4L Gen V (Sq. Ports)	1992-94	D805069 & Post ⑤	18-1261	—
Chevy 454/7.4L Gen V (Sq. Ports)	1995-97	D805069 & Post ⑤	18-1261	—
Chevy 502/8.2L	1990-92	C84992-F213244 ⑤	18-1256	18-1259
Chevy 502/8.2L Intraborda	1990-92	C878221-D857199 ⑤	18-1256	18-1259
Chevy 502/8.2L Gen V	1993-97	D824589 & Post ⑤	18-1261	—
Chevy 502/8.2L Gen V Intraborda	1993-97	D857200 & Post ⑤	18-1261	—
Ford 302/5.0L	1971-77	3108723-4887829 ④ ⑤	—	18-1273
Ford 351/5.8L	1975-77	4173000-4902304 ④ ⑤	—	18-1273
Ford 351/5.8L (Rev. Rota.)	1975-77	4173000-4902304 ④ ⑤ ①	—	18-1273

- ① Parte trasera de cigüeñal de una sola pieza
- ② Modelos 3.8L requiere 18-1211 Retén trasero cigüeñal y 18-0362 Junta carter
- ③ Modelos varilla aceite requiere 18-0411 kit juntas carter
- ④ Juego 4 piezas carter.
- ⑤ Incluye juntas de culata y de válvula

- ⑦ Junta colector escape/admisión incluidas en el kit
- ⑧ Se requiere cigüeñal trasero principal
- ① Se requiere juntas cigüeñal
- ② Modelos con varilla de empuje requieren 18-0328
- ③ Se necesitan los retenes del cigüeñal.
- ④ Use 18-4349 para los núm. de serie 6218462-B525981
- ⑤ Para modelos con un único retén trasero cigüeñal use 18-1206 kit



PRONAUTIC
MARINE EQUIPMENT

**COMPONENTES
INTERNOS
DE MOTOR**

COMPONENTES INTERNOS DE MOTOR

Base Motor 3.0L, 181 CID

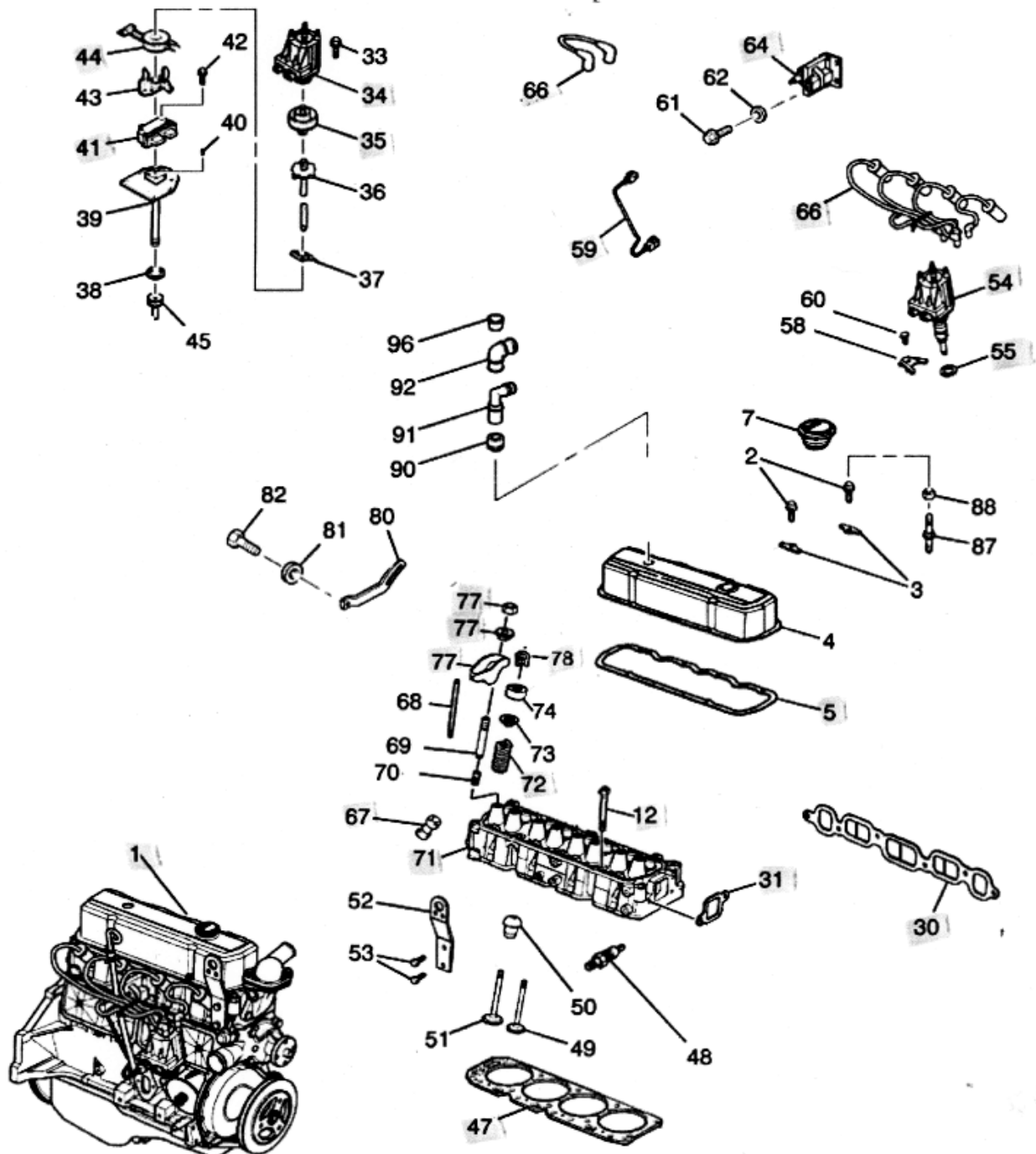

ENGINE 3.0L L4 (181 CID)

**JUEGO JUNTAS SUPERIOR

OTROS Componentes internos de motor

COMPONENTES INTERNOS DE MOTOR

Base Motor 3.0L, 181 CID

Descripción	Cant.	Ref. Original	Ref. PRONAUTIC
1. Bloque 3,0 Gm (INCLUYE: CARTER, BOMBA AGUA, DISTRIBUIDOR)	1		205202
5. Junta Tapa Balancines	1	27-52145/3852693/912981/913277	18-0347
12. Tornillo De Culata	10	10-34510/3857900	GMC1811321
30. Junta Colector Admision-Escape	1	12 7-815528/3853256/91457	18-0680
30. Junta Colector Admision-Escape	1	27-53354/908079	18-2912
30. Junta Colector Admision-Escape	1	27-96429/912164	18-1204
30. Junta Colector Admision-Escape	1	27-52546/311068	182896
31. Junta Cuerpo Termostato	1	27-814680/3852096/311069	18-2946
34. Tapa Distribuidor Encendido Electron.	1	811635, 811635T3 (ROTOR 18-5406)	18-5361
35. Rotor Encendido Electronico	1	811635, 811635T3 (ROTOR 18-5406)	18-5406
41. Modulo De Encendido 3,0-4,3-5,0-5,7	1	Para Distribuidores 3,0-4,3-5,0-5,7	18-5107-1
44. Bobina Captadora	1	811639	18-5108
47. Junta Culata	1	27-810841/3853336	18-2946
49. Valvula Admision	1	49,30x8,7x124	GMC3501521
49. Valvula Admision	1	40,70x8,7x125	GMC3501520
50. Reten Valvula (Tipo Aro Torico)	8	26-34217/3854956/914323	18-0518
51. Valvula Escape	1	40,60x8,7x125	GMC1811541
54. Distribuidor Completo	1	Tipo Est (Electronico)	18-5475
55. Junta Distribuidor	1	27-87707	18-0948
59. Cable Distribuidor A Bobina	1	84-817376T	205221
64. Bobina Encendido Convencional	1	392-898253T24 (Usa Resistencia Externa)	18-5433
64. Bobina Encendido Convencional	1	392-7803A4, 392-805570A2	18-5438
64. Bobina Encendido Electronico	1	898253T27,817378T	18-5443
66. Kit Cables De Bujia Encendido Conven.	1		18-8800-1
66. Kit Cables De Bujia Encendido Electron.	1		18-8811-1
67. Taquet De Valvula 3,0-4,3-5,0-5,7	8	con Rodillo	GMC3501082
67. Taquet De Valvula 3,0-4,3-5,0-5,7	8	Plano	GMC3501080
71. Culata Completa (Excepto Lx)	1	936-554, 936-810840/986767	18-4489
72. Muelle De Valvula	8	24-35214/3857898	GMC3501680
77. Kit Balancin Y Tuerca	8	35329	18-4492
78. Seguro Valvula	16	Semi-Cono	641052
** Juego Juntas Superior	1	Fel-Pro (17200)	GMC1811900
** Juego Juntas Superior	1	Sierra	18-1274

COMPONENTES INTERNOS DE MOTOR

Base Motor 3.0L, 181 CID

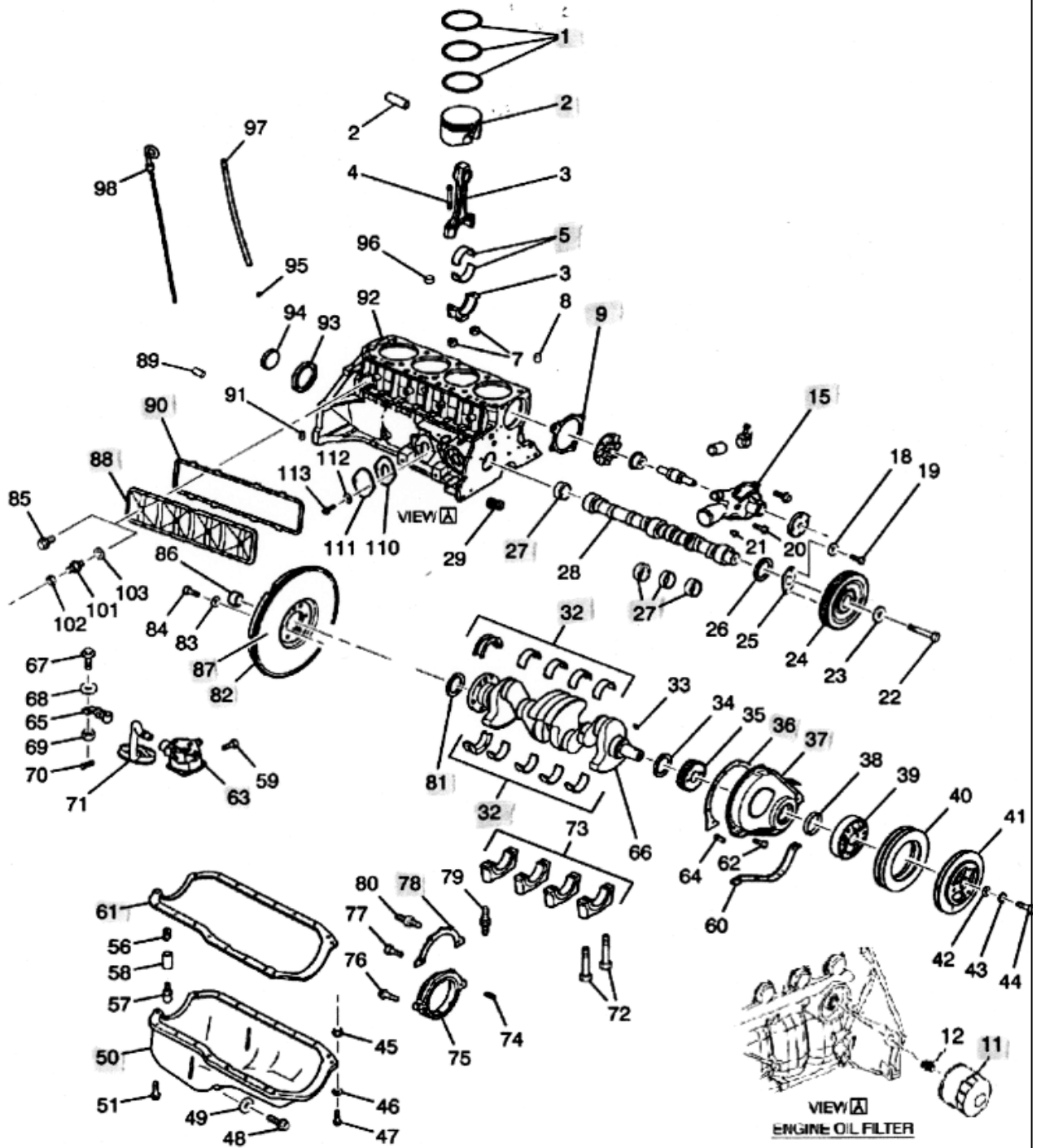

ENGINE 3.0L L4 (181 CID)

****JUEGO DE JUNTAS INFERIOR**

COMPONENTES INTERNOS DE MOTOR

Base Motor 3.0L, 181 CID

Descripción	Cant.	Ref. Original	Ref. PRONAUTIC
1. Juego Segmentos STD	4		GMC3501020
1. Juego Segmentos 020	4		GMC3501030
1. Juego Segmentos 030	4		GMC3501035
1. Juego Segmentos 040	4		GMC3501037
1. Juego Segmentos 060	4		GMC3501039
1. Juego Segmentos STD	4	Para Piston 18-4161	18-3937
1. Juego Segmentos 020	4	Para Piston 18-4160	18-3939
1. Juego Segmentos 030	4	Para Piston 18-4191	18-3938
1. Juego Segmentos STD	4	Para Piston 18-4180	18-3942
2. Piston STD (Segmentos no incluidos)	4	Modelo 3,0LX	GMC1811009
2. Piston 030 (Segmentos no incluidos)	4	Modelo 3,0LX	GMC1811009
2. Piston STD (Con cámara y seg. incluidos)	4	Modelo 3,0LX (Hasta s/n 0C856558)	18-4161
2. Piston 020 (Con cámara y seg. incluidos)	4	Modelo 3,0LX (Hasta s/n 0C856558)	18-4160
2. Piston 030 (Con cámara y seg. incluidos)	4	Modelo 3,0LX (Hasta s/n 0C856558)	18-4191
2. Piston STD (Segmentos incluidos)	4	Modelo 2,5L (s/n 1666601 en adelante)	18-4180
2. Piston 020 (Segmentos incluidos)	4	Modelo 2,5L (s/n 1666601 en adelante)	18-4183
2. Piston 030 (Segmentos no incluidos)	4	Modelo 2,5L (s/n 1666601 en adelante)	18-4166
5. Cojinte Biela	4	Estándar	GMC3501120
5. Cojinte Biela	4	010	GMC3501121
5. Cojinte Biela	4	020	GMC3501122
5. Cojinte Biela	4	030	GMC3501123
5. Cojinte Biela	4	040	GMC3501124
9. Junta Bomba de Agua	1	27-33956	18-0327
11. Filtro Aceite Corto	1	14957, 35-802885Q	18-7824
11. Filtro Aceite Largo	1	14957, 35-802885Q	18-7876
15. Bomba de Agua	1	65142A1	18-3575
15. Bomba de Agua	1	884727	18-3593
27. Cojinete	4	23-43293	GMC1811180
27. Cojinete	4	23-43293	18-1339
32. Juego Cojinetes Bancada	1	Estándar	GMC1811100
32. Juego Cojinetes Bancada	1	010	GMC1811105
32. Juego Cojinetes Bancada	1	020	GMC1811110
32. Juego Cojinetes Bancada	1	015	GMC1811115
36. Junta Tapa Distribución	1	27-49953	18-0887
37. Tapa Distribución	1	59341A1	633425
50. Carter	1	810845	MER810845
61. Junta Carter 1 Pieza	1	27-810846T	GMC1811961
61. Junta Carter 1 Pieza	1	27-810846T	18-1239
61. Junta Carter 4 Piezas	1	27-14901A1	GMC1811962
61. Junta Carter 4 Piezas	1	27-14901A1	18-0466
63. Bomba Aceite	1		GMC1811320
78. Junta Porta Reten Trasero	1	27-881715	18-0322
81. Reten	1	26-14240	18-0519
82. Corona Volante	1	157 DIENTES	GMC3501250
82. Corona Volante	1	168 DIENTES	GMC3501251
82. Corona Volante	1	180 DIENTES	GMC3501252
87. Volante	1	824320	MER824320
88. Tapa Empujadores	1	814702	MER814702
90. Junta Tapa Empujadores	1	27-814703	18-2815
** Juego Juntas Inferior	1	Reten Trasero de 2 Piezas (Sierra)	18-1271
** Juego Juntas Inferior	1	Reten Trasero de 2 Piezas (Fel-Pro 17101)	GMC1811921
** Juego Juntas Inferior	1	Reten Trasero de 1 Pieza (Fel-Pro 17102)	GMC1811922

COMPONENTES INTERNOS DE MOTOR

Base Motor 4.3L, 262 CID

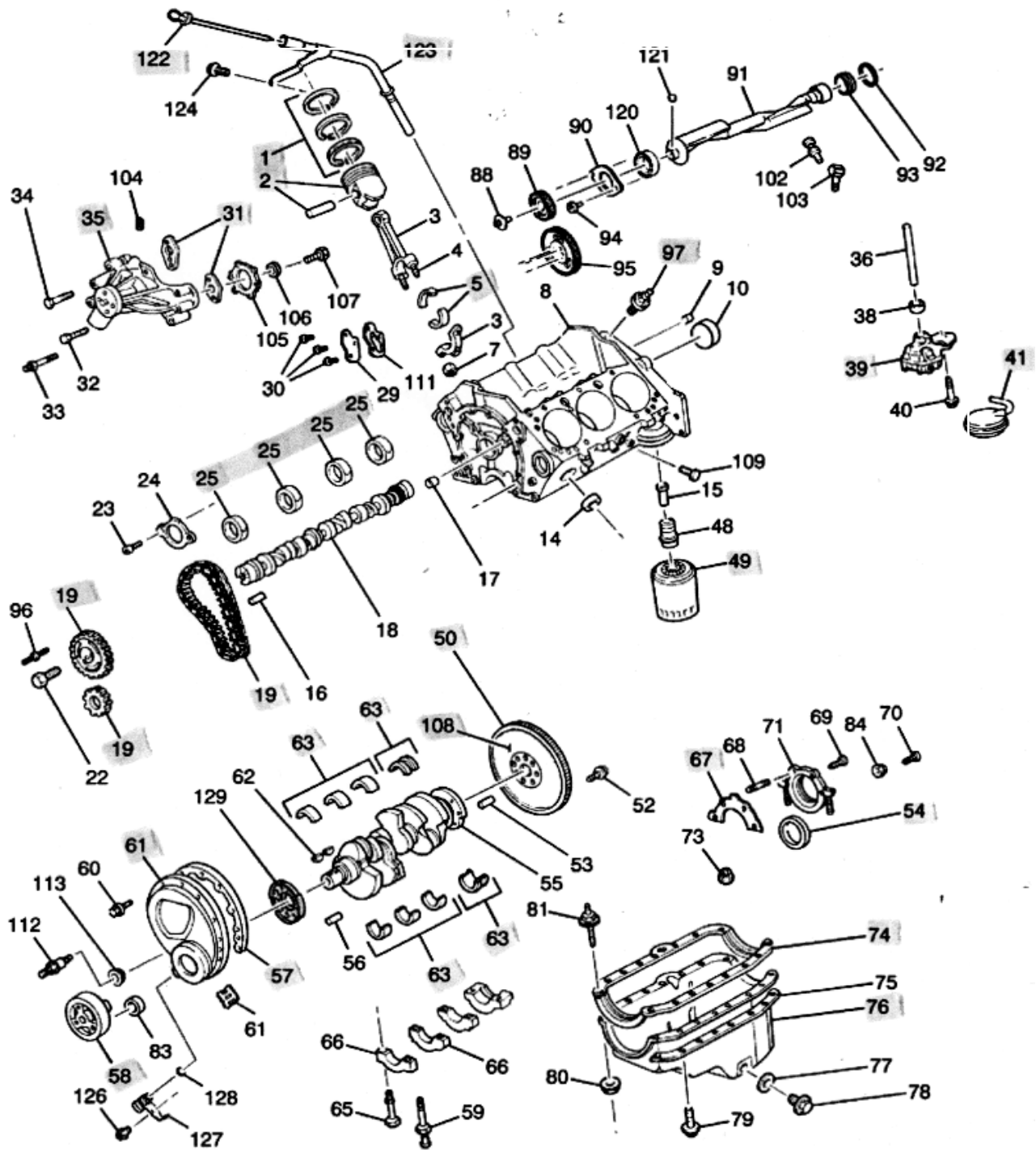

ENGINE 4.3L V6 PART 1 (262 CID)

**JUEGO DE JUNTAS INFERIOR

COMPONENTES INTERNOS DE MOTOR

Base Motor 4.3L, 262 CID

Descripción	Cant.	Ref. Original	Ref. PRONAUTIC
1. Juego Segmentos Vortec Std.	6	Med. 101,60x1,5x1,5x3	GMC3501021
1. Juego Segmentos Vortec 020"	6		GMC3501031
1. Juego Segmentos Vortec 030"	6		GMC3501036
1. Juego Segmentos Vortec 040"	6		GMC3501038
1. Juego Segmentos Std.	6	Med. 101,60x1,98x1,98x4,76	GMC3501020
1. Juego Segmentos 020"	6		GMC3501030
1. Juego Segmentos 030"	6		GMC3501035
1. Juego Segmentos 040"	6		GMC3501037
1. Juego Segmentos 060"	6		GMC3501039
2. Piston Gm Std	6	Std: 101,60 B:23,55 Ac:39,37	GMC3501000
2. Piston Gm 020"	6	Camara 69,85 Prof. 2.54 4 Fresados Val.	GMC3501004
2. Piston Gm 030"	6		GMC3501008
2. Piston Gm 040"	6		GMC3501012
2. Piston Gm 060"	6		GMC3501016
2. Piston Gm Std	6	Std: 101,60 B:23,55 Ac:39,12	GMC3501001
2. Piston Gm 020"	6	Cabeza Plana Con 4Fresados Val.	GMC3501005
2. Piston Gm 040"	6		GMC3501013
2. Piston Gm Std Vortec	6	Std:101,60 B:23,55 Ac:39,37	GMC2621002
2. Piston Gm 020"	6	Camara 69,85 prof. 2.54 4 fresados val.	GMC2621006
2. Piston Gm 030"	6		GMC2621010
2. Piston Gm 040"	6		GMC2621014
2. Piston Gm 060"	6		GMC2621018
5. Cojinete Biela Gm 4,3 Std.	6	Std: 57,13 Ancho 19,13	GMC2621120
5. Cojiente Biela Gm 4,3 025Mm Cojinete	6		GMC2621125
5. Biela Gm 4,3 050Mm	6		GMC2621130
5. Cojinete Biela Gm 4,3 075Mm	6		GMC2621135
5. Cojinete Biela Gm 4,3 1.00 Mm	6		GMC2621136
19. Kit Distribucion Gm 4,3-5,0-5,7	1	Eslabón Doble.Anclaje Piñón Levas 47mm	GMC3501220
19. Kit Distribucion Gm 4,3-5,0-5,7	1	Eslabón Sencillo. Anclaje Piñón Levas 40mm	GMC3501221
19. Kit Distribucion Gm 4,3-5,0-5,7	1	Eslabón Sencillo.Anclaje Piñón Levas 47mm	GMC3501222
19. Kit Distribucion Gm 4,3-5,0-5,7	1	Eslabon Rodillo. Anclaje Piñon Levas 47mm	GMC3501223
19. Kit Distribucion Gm 4,3	1	Motores Con Eje Equilibrador 1	GMC3501224
25. Kit Cojinetes Arbol Levas 4.3 Gm Std	1	Ext 51,28 Int 47,45X18,80 2-4 Ext 51,02 Int 47,45X18,92	GMC2621180
25.		3 Ext 50,77 Int 47,45X18,80 1	
25. Kit Cojinetes Arbol Levas 4.3 Gm Std	1	Ext 51,28 Int 47,45X18,80 2-4 Ext 50,80 Int 47,45X18,80	GMC2621181
25.		3 Ext 50,77 Int 47,45X18,80 1-4	
25. Kit Cojinetes Arbol Levas 4.3 Gm Std	1	Ext 51,28 Int 47,45X18,80 Ext 50,77 Int 47,45X18,80	GMC2621182
25.		2 Ext 50,77 Int 47,45X18,80 3 Ext 51,02 Int 47,45X19,92	
31. Junta Bomba De Agua Gm 4.3-5.0-5.7	2	27-34897/909835/3852477	18-0891
35. B0mba De Agua Gm 4.3-5.0-5.7	1	8503991/3851982/3853850	18-3599
39. Bomba Aceite Gm Std.	1	Caudal Std.	GMC3501320
39. Bomba Aceite Gm Std.	1	Alto Volumen	GMC3501321
39. Bomba Aceite Gm Vortec	1	Alto Volumen	GMC3501322
41. Filtro Bomba Aceite	1	Vortec	GMC3501326
41. Filtro Bomba Aceite	1	Standard	GMC3501325
49. Filtro Aceite Gm 4.3	1	35-883702Q/502903/841750	18-7879
50. Corona Volante Gm 4,3-5,0-5,7	1	157 Dientes	GMC3501250
50. Corona Volante Gm 4,3-5,0-5,7	1	168 Dientes	GMC3501251
50. Corona Volante Gm 4,3-5,0-5,7	1	180 Dientes	GMC3501252
54. Reten Trasero	1	26-14240/3852657 27-14250	18-0519
57. Junta Tapa Distribucion Gm 4.3-5.0-5.7	1		18-0976
57. Junta Tapa Distribucion Gm 4.3-5.0-5.7	1	27-811572/9153512/3852654	18-0468
58. Damper Gm 4,3	1		205247
61. Tapa Distribución Gm 4,3-5,0-5,7	1	Metalica	GMC3501384
61. Tapa Distribución Gm 4,3-5,0-5,7	1	6 Tornillos Con Sensor 8	GMC2621381
61. Tapa Distribución Gm 4,3-5,0-5,7	1	Tornillos Con Sensor	GMC2621382
63. Cojinete Bancada 4,3 Std.	1	Std:62,20 Ancho 20,49 Y 44, 14	GMC2621100
63. Cojiente Bancada 4,3 010"	1		GMC2621105
63. Cojinete Bancada 4,3 020"	1		GMC2621110
63. Cojinete Bancada 4,3 030"	1		GMC2621115
63. Cojinete Bancada 4.3 040"	1		GMC2621116
67. Junta Portareten Trasero	1		18-0322
74. Junta Carter Gm 4.3 (Chapa)	1	27-881715/27-14247/3852656	GMC2621960
74. Junta Carter Gm 4.3 (Chapa)	1	Reten Trasero 2 Piezas	GMC2621961
74. Junta Carter Gm 4.3 (Aluminio)	1	Reten Trasero 1 Pieza	GMC2621962
76. Carter	1	Vortec	18-0616
97. Kit Interruptor Gm 4.3-5.0-5.7	1	14244T (Chapa)	205229
108. Volante De Inercia 3,0-4,3-5,0-5,7	1	87-864252A01	MER824320
122. Varilla De Aceite Gm 4.3	1	Diámetro 14"	205254
123. Tubo Varilla De Aceite Gm 4,3	1	74Cm De Largo	205255
** Juego Juntas Inferior	1	Reten Trasero de 2 Piezas	GMC2621921
** Juego Juntas Inferior	1	Reten Trasero de 2 Pieza	GMC2621920

COMPONENTES INTERNOS DE MOTOR

Base Motor 4.3L, 262 CID

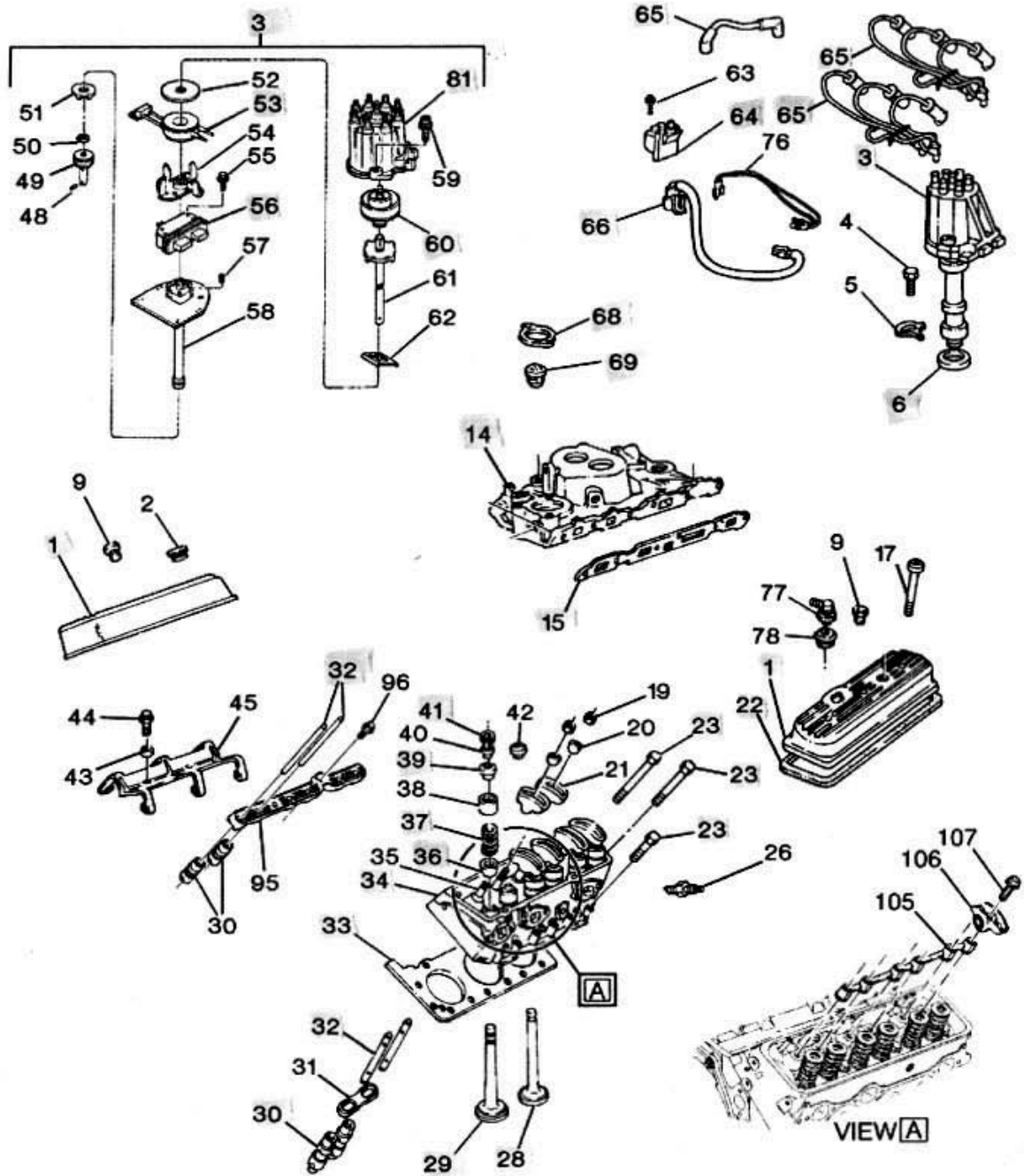

ENGINE 4.3L V6 (262 CID)

****JUEGO JUNTAS SUPERIOR**

COMPONENTES INTERNOS DE MOTOR

Base Motor 4.3L, 262 CID

Descripción	Cant.	Ref. Original	Ref. PRONAUTIC
1. Tapa Balancines	2	827149	205131
3. Distribuidor Completo	1	Incluido En Kit 205228	18-5476
3. Distribuidor Completo Mpi	1		18-5350
6. Junta Base Distribuidor	1	27-34486 3	18-0874
14. Colector Admision 2 Cuerpos Vortec Col-	1	Fijacion 8 Pernos	205242
14. ector Admision 4 Cuerpos Vortec	1	Fijacion 8 Pernos	205230
15. Kit Juntas Admision Vortec	1	27-8243261	18-0487
15. Kit Juntas Admision	1	24-824326	18-1238
22. Junta Tapa Balancines Vortec	1	Gmc2621970	641050
22. Junta Tapa Balancines	1		18-0311
23. Juego Tornillos Culata 4,3-5,0-5,7	1	27-11988	GMC3501720
28. Valvula Escape	6		GMC3501540
28. Valvula Escape	6	Medidas 38,10X8,7x125	GMC3501542
29. Valvula Admision	6	Medidas 38,10X9,4x125	GMC3501520
29. Valvula Admision	6	Medidas 43,70X8,7x125	GMC3501521
29. Valvula Admision	6	Medidas 49,30X8,7x124	GMC3501521
30. Taques de Valvula	12	Con Rodillo	GMC3501082
30. Taques de Valvula	12		GMC3501080
32. Varilla Balancin	12	Plano	GMC2621201
33. Junta Culata	1		18-3879
34. Culata Vortec (Balancines Con Rodillos)	2	27-816460	12557113
34. Culata Vortec	2	Casting 12557113	18-4491/205126
34. Culata 4,3 Standard (Remanufacturada)	2	Casting *772,*140	18-4490
34. Culata 4,3 Standard (Remanufacturada)	2	Casting *064, *209, *181, *626	14094768
36. Reten Valvula Admision	6	Casting *107, *476, *768, *268, *996, *066, *103	18-4024
37. Muelle De Valvula	12		GMC3501650
39. Reten Valvula Admision-Escape	12	3.0L, 4.3L, 5.0L Y 5.7L	18-0518
41. Seguro Valvula	24	(Tipo O-Ring)	641052
53. Bobina Captador	1	Semi-Cono	18-5108
56. Modulo Encendido Distribuidor	1	811639T	18-5107-1
60. Rotor (Tapa Encendido Electronico)	1	811637001	18-5408
60. Rotor (Tapa Encendido Electro. Redondo)	1	850485 (Tapa 18-5362)	18-5432
60. Rotor(Tapa Encen.Convencional Redondo)	1	13524A6 (Tapa 18-5396)	18-5403
64. Bobina Encendido Convencional	1	392-9089 (Tapa 18-5353)	18-5438
64. Bobina Encendido Electronico	1	392-7803A4, 392-805570A2	18-5443
65. Kit Cables Bujia Encendido Electronico Kit	1	898253T27, 817378T	18-8801-1
65. Cables Bujia Encendido Mpi	1	84-816761Q7 (Tapa 18-5353)	18-8828-1
65. Kit Cables Bujia Encendido Estándar	1	(Kit V8)	18-8810-1
65. Kit Cables Bujia Encendido Electronico	1	84-816761Q16 (Tapa 18-5396)	18-8835-1
66. Cable Distribuidor A Bobina	1	84-816608Q82 (Tapa 18-5362)	205221
68. Junta Termostato	1		18-0398
69. Termostato	1		MERCURISER
69. Termostato	1	Ver pág. 632	OMC
69. Termostato	1	Ver pág. 773-774	VOLVO
81. Tapa Distribuidor Electronico	1	Ver pág. 857	18-5362
81. Tapa Distribuidor Electronico Redondo	1	850484T, T2	18-5396
81. Tapa Distribuidor Electronico Redondo	1	13753A2, 815407A2	18-5355
81. Tapa Distribuidor Mpi	1	392-9086, T (Cables 18-8801-1)	18-5243
** Juego Juntas Superior	1	888731, 898253T23	GMC2621900
** Juego Juntas Superior	1	Motores Con Carter de Chapa	GMC2621902
** Juego Juntas Completo de Motor	1	Motores Con Carte de Aluminio	18-4388
** Jgo. Juntas Completo de Motor (Vortec)	1	Motores Con Carter de Chapa	18-4388A
		Motores Con Carte de Aluminio	

COMPONENTES INTERNOS DE MOTOR

Base Motor 5.0 - 5.7L, 305 CID y 350 CID

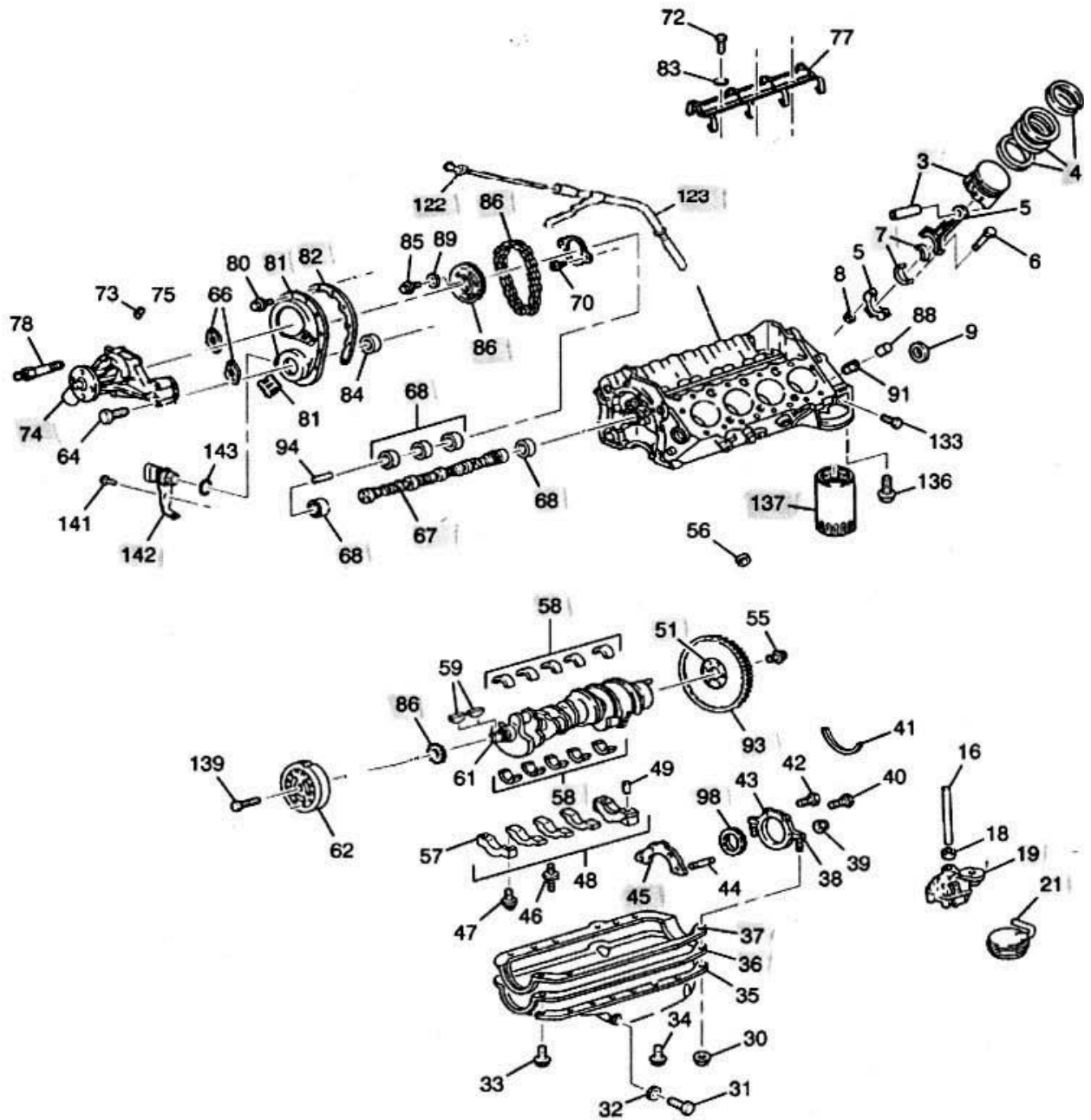

ENGINE 5.0 - 5.7L V8 (305 CID) (350 CID)

****JUEGO JUNTAS INFERIOR**

COMPONENTES INTERNOS DE MOTOR

Base Motor 5.0 - 5.7L, 305 CID y 350 CID

Descripción	Cant.	Ref. Original	Ref. PRONAUTIC
3. Piston Gm 4,3- 5,7 Std	8	Std: 101,60 B:23,55 Ac:39,37	GMC3501000
3. Piston Gm 4,3-5,7 020"	8	Camara 69,85 Prof. 2,54 4 Fresados Val.	GMC3501004
3. Piston Gm 4,3-5,7 030"	8		GMC3501008
3. Piston Gm 4,3-5,7 040"	8		GMC3501012
3. Piston Gm 4,3-5,7 060"	8		GMC3501016
3. Piston Gm 4,3-5,7 Std	8	Std: 101,60 B:23,55 Ac:39,12	GMC3501001
3. Piston Gm 4,3-5,7 020"	8	Cabeza Plana Con 4 Fresados Val.	GMC3501005
3. Piston Gm 4,3-5,7 040"	8		GMC3501013
3. Piston Gm 4.3-5,7 Vortec Std.	8	Std:101,60 B:23,55 Ac: 39,37	GMC2621002
3. Piston Gm 4,3-5,7 Vortec 020"	8		GMC2621006
3. Piston Gm 4,3-5,7 Vortec 030"	8		GMC2621010
3. Piston Gm 4,3-5,7 Vortec 040"	8		GMC2621014
3. Piston Gm 4,3-5,7 Vortec 060"	8		GMC2621018
3. Piston Gm 5,0 Std.	8	Std: 94,90 B:23,55 Ac:39,12	GMC3051000
3. Piston Gm 5,0 020"	8	Camara 79,12 Prof. 2,79	GMC3051005
3. Piston Gm 5,0 030"	8		GMC3051015
3. Piston Gm 5,0 040"	8		GMC3051013
3. Piston Gm 5,0 060"	8		GMC3051018
3. Piston Gm 5,0 Std.	8	Std: 94,90 B:23,55 Ac:39,12	GMC3051002
3. Piston Gm 5,0 020"	8	Camara 79,50 Prof. 1,57 4 Fresados Val.	GMC3051007
3. Piston Gm 5,0 030"	8		GMC3051017
3. Piston Gm 5,0 040"	8		GMC3051012
3. Piston Gm 5,0 060"	8		GMC3051019
3. Piston Gm 5,0 Std.	8	Std: 94,90 B:23,55 Ac:39,12	GMC3051003
3. Piston Gm 5,0 020"	8	Cabeza Plana Con 4 Fresados Val.	GMC3051008
3. Piston Gm 5,0 030"	8		GMC3051009
3. Piston Gm 5,0 040"	8		GMC3051014
3. Piston Gm 5,0 060"	8		GMC3051019-1
3. Piston Gm 5,0 Vortec Std	8	Std: 94,90 B:23,55 Ac:39,37	GMC3051001
3. Piston Gm 5,0 Vortec 020"	8	Camara 80,26 Prof.1,40	GMC3051006
3. Piston Gm 5,0 Vortec 030"	8		GMC3051016
3. Piston Gm 5,0 Vortec 040"	8		GMC3051011
4. Juego Segmentos 4,3-5,7 Vortec Std.	8	Med. 101,60X1,5x1,5x3	GMC3501021
4. Juego Segmentos 4,3-5,7 Vortec 020"	8		GMC3501031
4. Juego Segmentos 4,3-5,7 Vortec 030"	8		GMC3501036
4. Juego Segmentos 4,3-5,7 Vortec 040"	8		GMC3501038
4. Juego Segmentos 4,3-5,7 Std.	8	Med. 101,60X1,98x1,98x4,76	GMC3501020
4. Juego Segmentos 4,3-5,7 020"	8		GMC3501030
4. Juego Segmentos 4,3-5,7 030"	8		GMC3501035
4. Juego Segmentos 4.3-5,7 040"	8		GMC3501037
4. Juego Segmentos 4,3-5,7 060"	8		GMC3501039
4. Juego Segmentos 5,0 Vortec Std.	8	Med. 94,90X1,98x1,98x4,76	GMC3051021
4. Juego Segmentos 5,0 Vortec 020"	8	Ancho Lamina Seg. Engrase 3,20 Mm	GMC3051031
4. Juego Segmentos 5,0 Vortec 030"	8		GMC3051028
4. Juego Segmentos 5,0 Vortec 040"	8		GMC3051037
4. Juego Segmentos 5,0 Vortec 060"	8		GMC3051036
4. Juego Segmentos 5,0 Std.	8	Med. 94,90X1,98x1,98x4,76	GMC3051020
4. Juego Segmentos 5,0 020"	8	Ancho Lamina Seg. Engrase 3,90 Mm	GMC3051030
4. Juego Segmentos 5,0 030"	8		GMC3051035
4. Juego Segmentos 5,0 040"	8		GMC3051038
4. Juego Segmentos 5,0 060"	8		GMC3051039

sigue > >

COMPONENTES INTERNOS DE MOTOR

Base Motor 5.0 - 5.7L, 305 CID y 350 CID

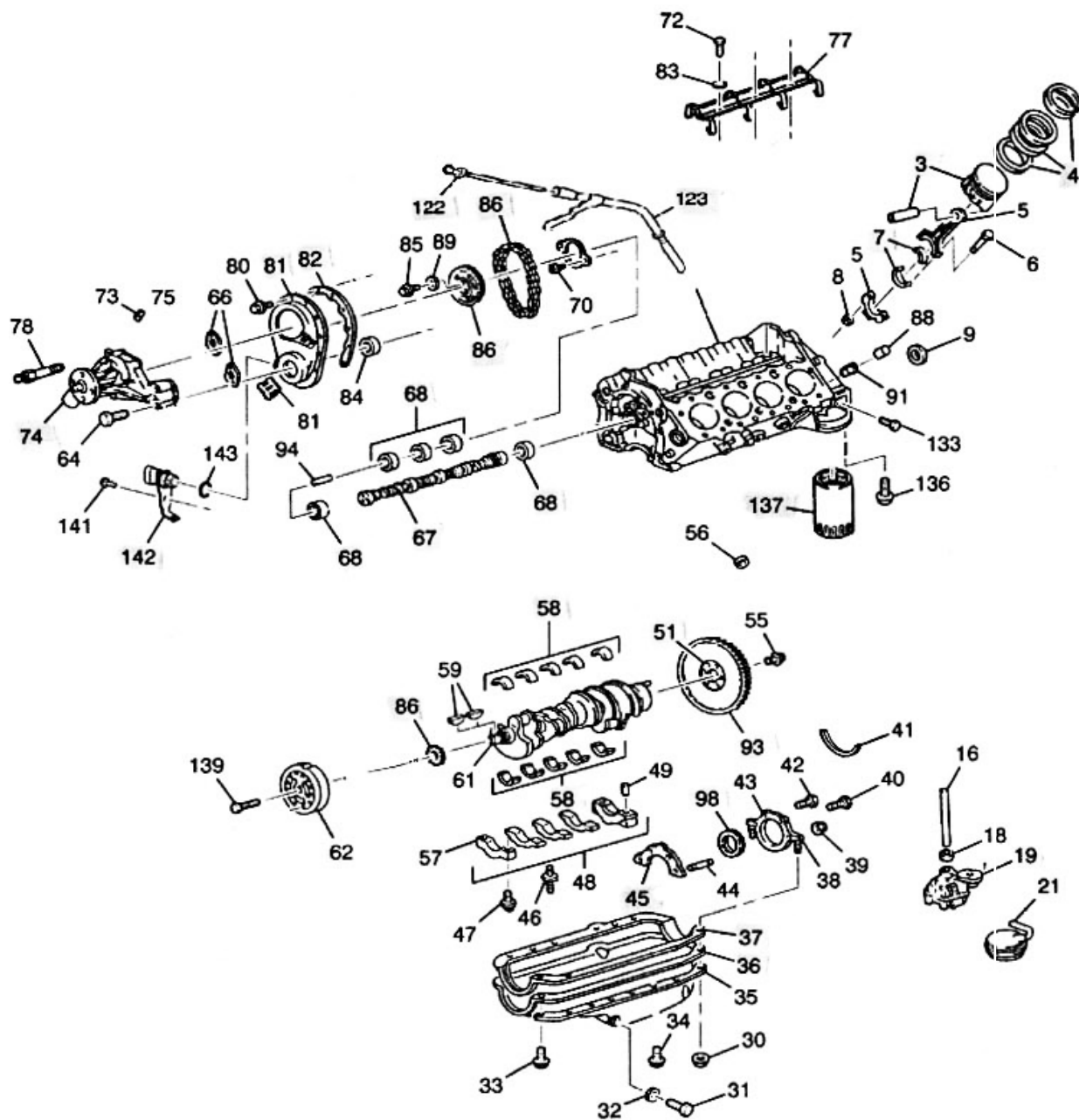

ENGINE 5.0 - 5.7L V8 (305 CID) (350 CID)

**JUEGO JUNTAS INFERIOR

COMPONENTES INTERNOS DE MOTOR

Base Motor 5.0 - 5.7L, 305 CID y 350 CID

Descripción	Cant.	Ref. Original	Ref. PRONAUTIC
7. Cojinete Biela Gm 5,7-5,0-3,0 Std Coji-	8	Std: 53,33 Ancho 21,39	GMC3501120
7. nete Biela Gm 5,7-5,0-3.0 010" Cojinete	8		GMC3501121
7. Biela Gm 5,7-5,0-3,0 020" Cojinete Biela	8		GMC3501122
7. Gm 5,7-5,0-3,0 030"	8		GMC3501123
7. Cojinete Biela Gm 5,7-5,0-3,0 040"	8		GMC3501124
19. Bomba Aceite Gm Std.	1	Caudal Std.	GMC3501320
19. Bomba Aceite Gm Std.	1	Alto Volumen	GMC3501321
19. Bomba Aceite Gm Vortec	1	Alto Volumen	GMC3501322
21. Filtro Bomba Aceite	1	Vortec	GMC3501326
21. Filtro Bomba Aceite	1	Standard	GMC3501325
31. Junta Bomba De Agua Gm 4.3-5.0-5.7	2	2734897/909835/3852477	18-0891
36. Carter Gm 5.0-5.7	1	Reten Trasero de 2 Piezas. Varilla Estribor	18-0613
36. Carter Gm 5.0-5.7	1	Reten Trasero de 1 Pieza	18-0612
37. Junta Carter Gm 5.0-5.7	1	Reten Trasero de 2 Piezas. Varilla Babor	GMC3501960
37. Junta Carter Gm 5.0-5.7	1	Reten Trasero de 2 Piezas. Varilla Estribor	GMC3501961
37. Junta Carter Gm 5.0-5.7	1	Reten Trasero de 1 Pieza	GMC3501962
45. Junta Portareten Trasero	1	27-881715/27-14247/3852656	18-0322
51. Volante De Inercia	1	Diametro 14"	MER824320
58. Cojinete Bancada Gm 5,7 Y 5,0 Std	8	Std: 62,20 Ancho 20,49 Ancho 44,14	GMC3501100
58. Cojiente Bancada Gm 5,7 Y 5,0 010"	8		GMC3501105
58. Cojinete Bancada Gm 5,7 Y 5,0 020"	8		GMC3501110
58. Cojinete Bancada Gm 5,7 Y 5,0 030"	8		GMC3501115
58. Cojinete Bancada Gm 5,7 Y 5,0 040"	8		GMC3501116
58. Cojinete Bancada Gm 5,7 Y 5,0 060"	8		GMC3501119
68. Cojinete Arbol De Levas 5,7	1	Kit Estandar	GMC3501180
68. Cojinete Arbol De Levas 5,0	1	Kit Estandar	GMC3051180
74. Bomba De Agua Gm 4.3-5.0-5.7	1	8503991/3851982/3853850	18-3599
81. Tapa Distribucion Gm 4,3-5,0-5,7	1	Metalica	GMC3501384
81. Tapa Distribucion Gm 4,3-5,0-5,7	1	6 Tornillos con Sensor	GMC2621381
81. Tapa Distribucion Gm 4,3-5,0-5,7	1	8 Tornillos con Sensor	GMC2621382
82. Junta Tapa Distribucion Gm 4.3-5.0-5.7	1	27-14250	18-0976
82. Junta Tapa Distribucion Gm 4.3-5.0-5.7	1	27-811572/9153512/3852654	18-0468
86. Kit Distribución 4,3-5,0-5,7	1	Eslabón Doble. Anclaje Piñón Levas 47Mm	GMC3501220
86. Kit Distribución 4,3-5,0-5,7	1	Eslabón Sencillo. Anclaje Piñón Levas 40Mm	GMC3501221
86. Kit Distribución 4,3-5,0-5,7	1	Eslabón Sencillo. Anclaje Piñón Levas 47Mm	GMC3501222
86. Kit Distribución 4,3-5,0-5,7	1	Eslabón Rodillo. Anclaje Piñón Levas 47Mm	GMC3501223
93. Corona Volante Gm 4,3-5,0-5,7	1	157 Dientes	GMC3501250
93. Corona Volante Gm 4,3-5,0-5,7	1	168 Dientes	GMC3501251
93. Corona Volante Gm 4,3-5,0-5,7	1	180 Dientes	GMC3501252
98. Reten Trasero	1	26-14240/3852657	18-0519
122. Varilla Aceite Gm 5.0-5.7	1	57 Cm de Largo	205257
123. Tubo Varilla Aceite Gm 5.0-5.7	1		205256
137. Filtro Aceite Gm 3.0-5.0-5.7	1	35-866340Q03/502902/835440	18-7824
137. Filtro Aceite Gm 3.0-5.0-5.7	1	Filtro Alto Volumen	18-7876
142. Sensor De Posicion De Cigüeñal Juego	1	864297001, 3858979	18-7706
** Junta Inferior	1	Reten Trasero de 2 Piezas (Fel-Pro 17120)	GMC3501920
** Juego Junta Inferior	1	Reten Trasero de 1 Pieza (Fel-Pro 17125)	GMC3501921
** Juego Junta Inferior	1	Reten Trasero de 2 Piezas (Sierra)	18-1265
** Juego Junta Inferior	1	Reten Trasero de 1 Pieza (Sierra)	18-1268

COMPONENTES INTERNOS DE MOTOR

Base Motor 5.0 - 5.7L, 305 CID y 350 CID

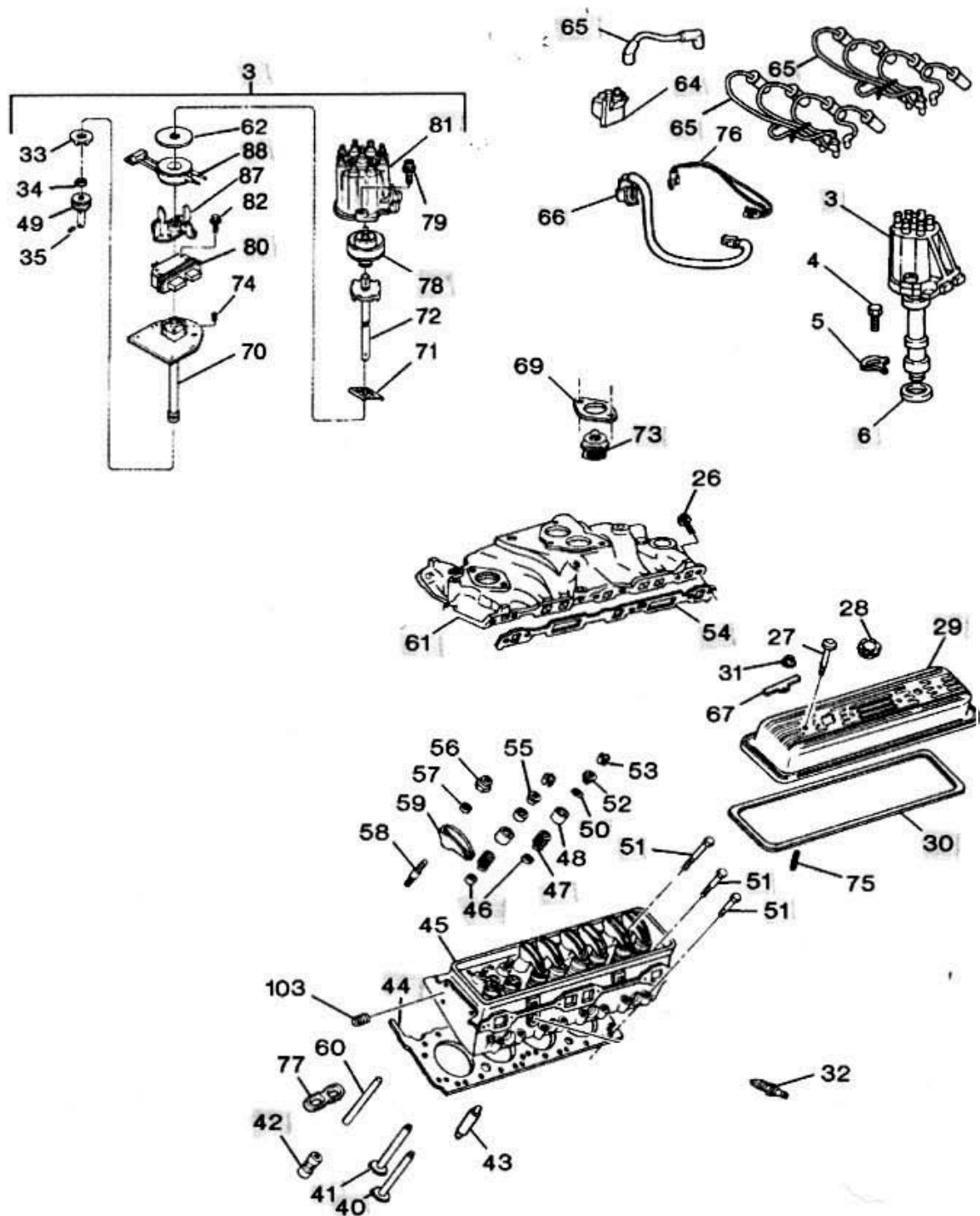

ENGINE 5.0 - 5.7L V8 (305 CID)(350 CID)

**JUEGO JUNTAS SUPERIOR

COMPONENTES INTERNOS DE MOTOR

Base Motor 5.0 - 5.7L, 305 CID y 350 CID

Descripción	Cant.	Ref. Original	Ref. PRONAUTIC
3 Distribuidor Electronico	1	Incluido En Kit 205235	18-5484
3 Distribuidor Electronico Mpi	1		18-5351
3 Distribuidor Convencional	1		18-5313
6 Junta Distribuidor	1		18-0874
29 Tapa Balancines	2	Tornillos en el Centro Tornil-	
29 Tapa Balancines	2	los en el Perimetro	
30 Junta Tapa Balancines	1	Tornillos en el Perímetro	18-2845
30 Junta Tapa Balancines	1	Tornillos en el Centro	18-0664
40 Valvula de Escape 4,3-5,0-5,7	8	38,10X8,7x125	GMC3501540
40 Valvula de Escape 4,3-5,0-5,7	8	38,10X9,4x125	GMC3501542
41 Valvula de Admision 3,0-4,3-5,7	8	43,70X8,7x125	GMC3501520
41 Valvula de Admision 3,0-4,3-5,7	8	49,30X8,7x124	GMC3501521
41 Valvula de Admision 5,0	8	46,70X8,7x125	GMC3051521
42 Taquets de Rodillo	16	para 3,0-4,3-5,0-5,7	GMC3501082
42 Taquets Plano	16	para 3,0-4,3-5,0-5,7	GMC3501080
44 Junta Culata 5,0-5,7	2		18-3876
46 Reten Admisión	8		18-4024
47 Muelle 3,0-4,3-5,0-5,7	16		GMC3501650
50 Reten Admisión-Escape	16	Tipo O-Ring	18-0518
51 Juego Tornillos Culata V6-V8	2		GMC3501720
53 Seguro Valvula	1	Semi-Cono (Unidad)	641052
54 Juntas Colector Admisión Vortec	1		18-0488
54 Juntas Colector Admisión Standard	1		18-0868
61 Colector Admision Vortec 5,0-5,7	1	Aluminio y Galerias de Bronce	18-7628
64 Bobina Encendido Electronico	1	898253T27, 817378T	18-5443
64 Bobina Encendido Convencional	1	392-7803A4, 392-805570A2	18-5438
64 Bobina Encendido Electronico	1	806673T1 (Motores Efi Y Tbi)	18-5442
65 Kit Cables Bujias Distr.Electr.Redondo	1	para Tapas 18-5380/18-5395	18-8804-1
65 Kit Cables Bujias Distr. Convencional	1	para Tapa 18-5376	18-8802-1
65 Kit Cables Bujias Distribuidor Mpi	1	para Tapa 18-5244	18-8828-1
65 Kit Cables Bujias Distribuidor Electr.	1	para Tapa 18-5354	18-8836-1
66 Cable Distribuidor A Bobina	1	84-817376T	205221
73 Termostato	1		MERCURISER
73 Termostato	1		OMC
73 Termostato	1		VOLVO
78 Rotor (Encendido Electronico)	1	808484 1, 898253010 (Tapa 18-5354) 13524A5	18-5405
78 Rotor (Encendido Electron. Redondo) Ro-	1	(Tapas 18-5380/18-5395)	18-5431
78 tor (Encendido Mpi)	1	884790, 898253013 (Tapa 18-5244)	18-5245
78 Rotor Encendido Convencional	1	391-7057,391-5088 (Tapa 18-5376)	18-5404-1
80 Modulo Encendido Distribuidor	1	811637001	18-5107-1
81 Tapa Distribuidor Electronico	1	para Distribuidor 18-5484	18-5354
81 Tapa Distribuidor Electronico Mpi	1	para Distribuidor 18-5351	18-5244
81 Tapa Distribuidor Convencional	1	para Distribuidor 18-5313	18-5376
81 Tapa Distribuidor Electronico	1	para Distribuidor Redondo	18-5380/18-5395
88 Bobina Captador	1	811639,T (Para Distr. 18-5484)	18-5108
** Juego Juntas Superior 5,0(Fel-Pro 17224)	1	Tornillos Tapa de Válvulas en el Centro	GMC3051901
** Juego Juntas Superior 5,0(Fel-Pro 17220)	1	Tornillos Tapa de Válvulas en el Perimetro	GMC3051900
** Juego Juntas Superior 5,7(Fel-Pro 17214)	1	Tornillos Tapa de Válvulas en el Centro	GMC3501902
** Juego Juntas Superior 5,7(Fel-Pro 17230)	1	Tornillos Tapa de Válvulas en el Perimetro	GMC3501900
** Juego Juntas Superior 5,7(Fel-Pro 17232)	1	Vortec	GMC3501903

COMPONENTES INTERNOS DE MOTOR

Base Motor 7.4L, 454 CID

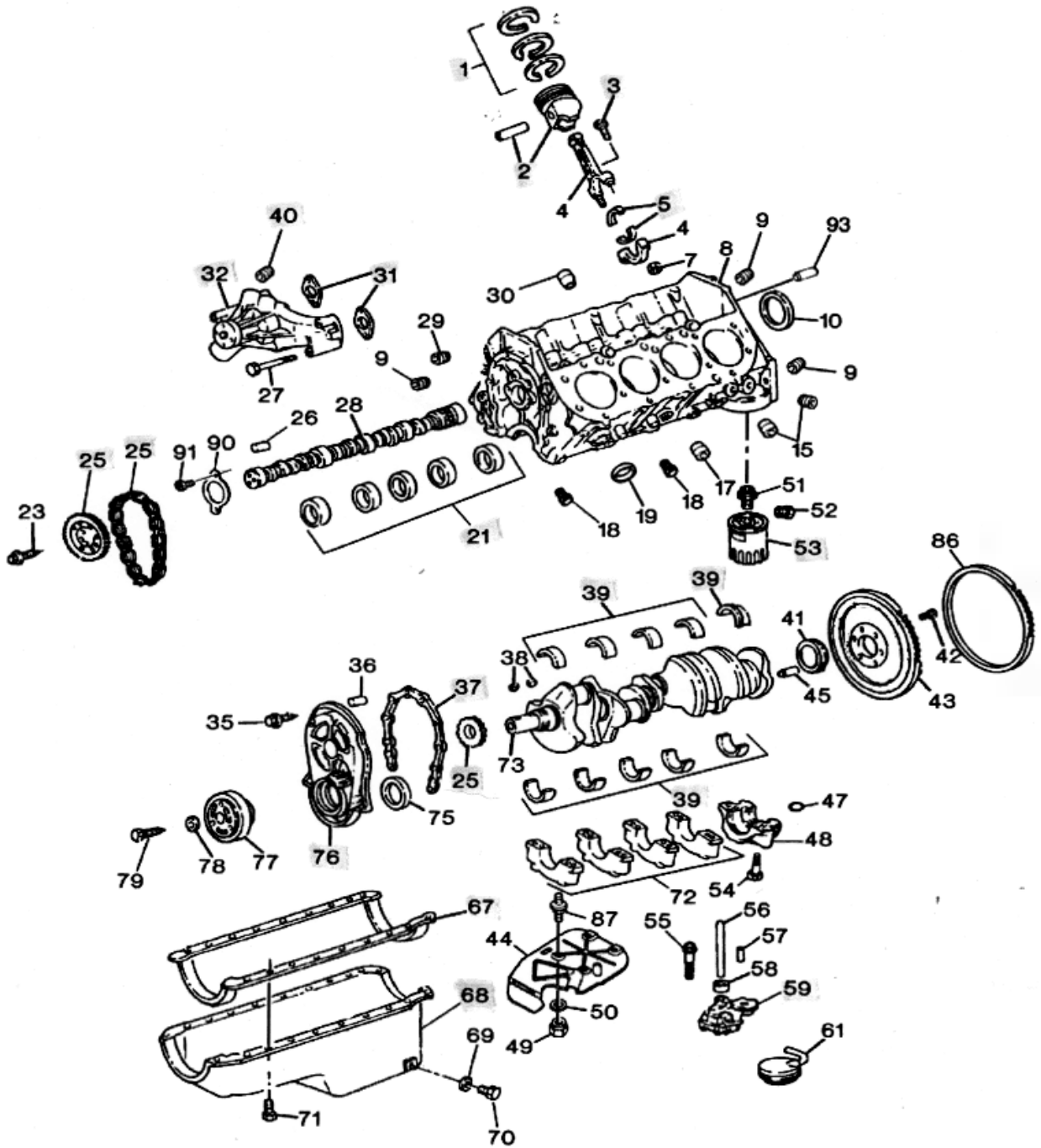

ENGINE 7.4L V8 PART 1 (454 CID)

****JUEGO JUNTAS PARTE INFERIOR**

COMPONENTES INTERNOS DE MOTOR

Base Motor 7.4L, 454 CID

Descripción	Cant.	Ref. Original	Ref. PRONAUTIC
1. Juego Segmentos Std	8	107,95X1,98x1,98x4,76 Engrase 3,90	GMC4541020
1. Juego Segmentos 020"	8		GMC4541030
1. Juego Segmentos 030"	8		GMC4541035
1. Juego Segmentos 040"	8		GMC4541037
1. Juego Segmentos 060"	8		GMC4541039
1. Juego Segmentos Std Vortec Gen V Y Vi	8	107,95X1,98x1,98x4,76 Engrase 2,60	GMC4541021
1. Juego Segmentos Std 8,2	8	113,44X2x1,5x4	GMC5021020
2. Piston 7,4 Std. (Segmentos no Incluidos)	8	2 Fresados Val. Diam: 107,95 Bulon: 25,13 Ac:41,27	GMC4541000
2. Piston 7,4 020" (Segmentos no Incluidos)	8		GMC4541005
2. Piston 7,4 030" (Segmentos no Incluidos)	8		GMC4541014
2. Piston 7,4 040" (Segmentos no Incluidos)	8		GMC4541016
2. Piston 7,4 060" (Segmentos no Incluidos)	8		GMC4541018
2. Piston 7,4 Std Magnun (Seg. no Incluidos)	8	Diam. 107,95 Bulon: 25,13 Ac:41,78 Defl ector 2,41	GMC4541001
2. Piston 7,4 030" Magnun (Seg. no Incluidos)	8		GMC4541015
5. Cojinete Biela Std	8	Diametro 55,86 Ancho 22,66	GMC4541120
5. Cojinete Biela 010	8		GMC4541125
5. Cojinete Biela 020	8		GMC4541130
5. Cojinete Biela 030	8		GMC4541135
5. Cojinete Biela 040	8		GMC4541138
21. Kit Cojinetes Arbol Levas	1		GMC4541180
25. Kit Distribucion 7,4	1		GMC4541220
31. Junta Bomba Agua 7,4	2		18-0903
32. Bomba de Agua 7,4	1		18-3577
32. Bomba de Agua 8,1	1	(Motores con Tapa Distribucion De Plastico)	18-3573
37. Junta Tapa Distribución (Metalicas)	1	27-54529	18-0980
39. Cojinete Bancada 7,4 Std	1	69,82X26,60 4Uds 69,82X45,99 1 Ud	GMC4541100
39. Cojinete Bancada 7,4 010"	1		GMC4541105
39. Cojinete Bancada 7,4 020"	1		GMC4541110
39. Cojinete Bancada 7,4 030"	1		GMC4541112
39. Cojinete Bancada 7,4 040	1		GMC4541116
40. Entronque	1	Fabricado en Inox	800007
53. Filtro Aceite Corto	1	14957, 35-8028850,54111	18-7824
53. Filtro Aciete Largo	1	14957, 35-8028850,54111	18-7876
59. Bomba Aceite 7,4	1	85805, 808693A1	GMC4541320
67. Junta Carter 1 Sola Pieza	1	27-811566	18-1232
67. Junta Carter 2 Piezas	1	27-52550	18-0348
67. Junta Carter 2 Piezas	1	27-52550 (Fel-Pro 17985)	GMC4541960
67. Junta Carter 1 Sola Pieza	1	27-811566 (Fel-Pro 17986)	GMC4541961
68. Carter (Jta. No Incluida)	1	845668T (Jta. Carter 1 Sola Pieza)	18-0614
68. Carter (Jta. Incluida)	1	93477T (Jta. Carter 2 Piezas)	18-0615
76. Tapa Distribucion 7,4 (Metalica)	1	Con Indicador	GMC4541380
** Juego de Juntas Generación IV	1	Reten Trasero de 2 Piezas (Fel-Pro 17140)	GMC4541920
** Juego de Juntas Generacion V	1	Reten Trasero de 1 Pieza (Fel-Pro 17145)	GMC4541921
** Juego de Juntas Generacion IV	1	Reten Trasero de 2 Piezas (Sierra)	18-1256

COMPONENTES INTERNOS DE MOTOR

Base Motor 7.4L, 454 CID

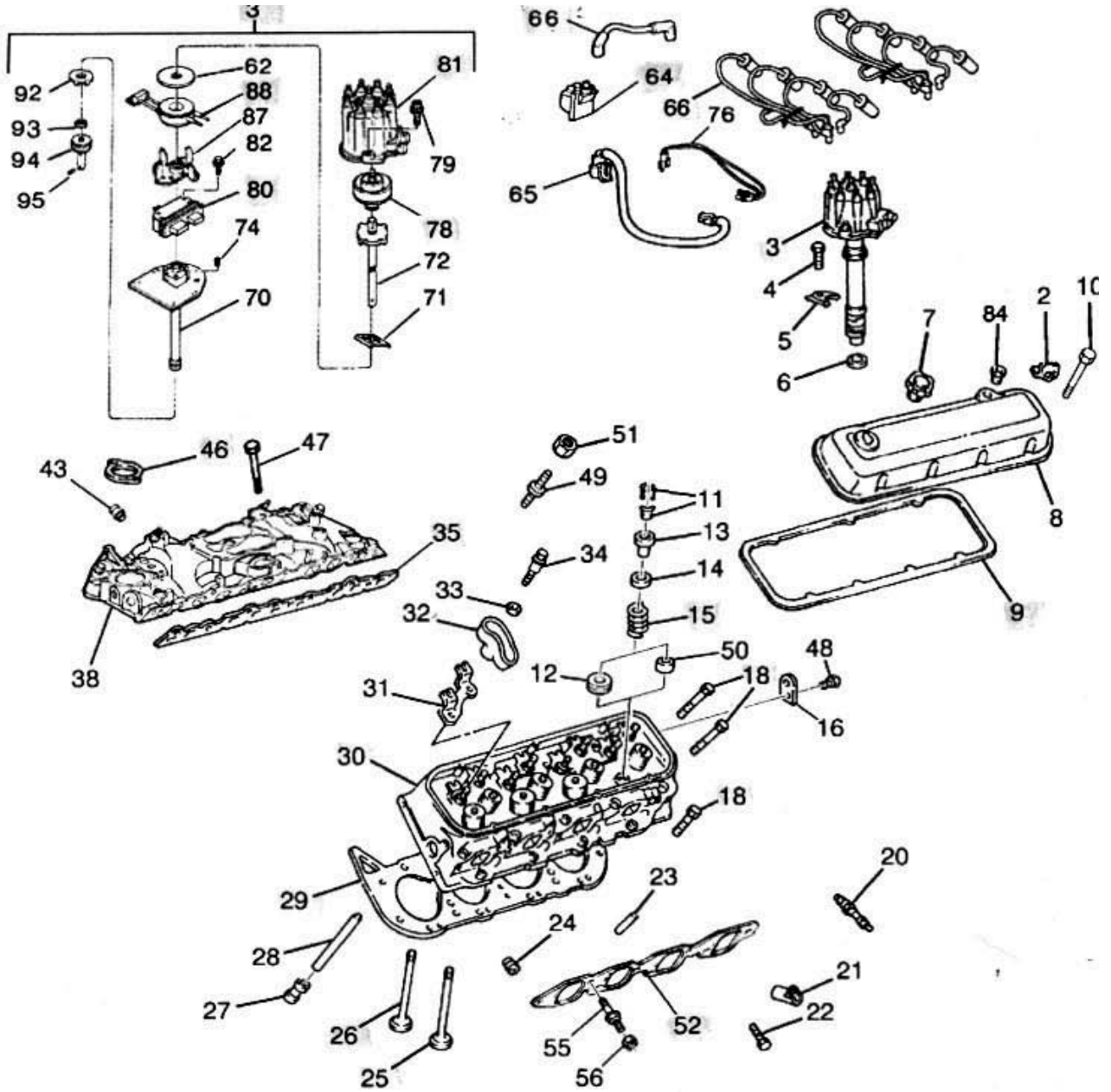

ENGINE 7.4L V8 PART 2 (454 CID)

***JUEGO DE JUNTAS PARTE SUPERIOR**

COMPONENTES INTERNOS DE MOTOR

Base Motor 7.4L, 454 CID

Descripción	Cant.	Ref. Original	Ref. PRONAUTIC
3 Distribuidor Elctronico HEI	1	Incluido En Kit 205235	18-5484
9 Junta Tapa Balancines 7,4	2	27-14765	18-25001
9 Junta Tapa Balancines 7,4 Y 8,2	2	27-811588 (Tipo O-Ring)	18-25002
9 Junta Tapa Balancines 7,4 Y 8,2	2	27-49121, 912768	18-0464
15 Muelle	16	Doble	GMC4541680
15 Muelle	16	Normal	GMC4541681
15 Muelle	16	Con Refuerzo De Chapa En Base	GMC4541682
18 Kit Tornillos Culata	2		GMC4541720
25 Valvula Admisión	16	46,70X9,4x133	GMC4541520
25 Valvula Admisión	16	52,40X9,4x133	GMC4541521
25 Valvula Admisión Magnun	16	55,60X9,4x132	GMC4541522
26 Valvula Escape	16	43,60X9,4x136	GMC4541540
26 Valvula Escape Magnun	16	47,60X9,4x136	GMC4541541
27 Taquet	16	con Rodillo	GMC4541082
27 Taquet	16	Plano	GMC4541080
29 Junta Culata	2	27-13687, 914849	18-3877
29 Junta Culata	2	27-850470, 915325, 3853511	18-3887
29 Junta Culata 8,2	2	27-811207, 3853511, 915325	18-3873
29 Junta Culata 8,2	2	27-811546	18-3874
30 Culata Completa	2	*Indicar Número De Fundicion	203024
35 Junta Colector Admisión	2	27-818188-1, 3854095	18-1231
35 Junta Colector Admisión	1	27-65184, 352670, 14024393	18-0465
46 Junta Cuerpo Termostato	1	27-530451	18-0398
52 Junta Escape	1	27-46820, 3852472	18-0418
64 Bobina Encendido Convencional	1	392-7803A4, 392805570A2	18-5438
64 Bobina Encendido Electrónico	1	806673T1 (Motores EFI Y TBI)	18-5442
64 Bobina Encendido Electrónico	1	898253T27, 817378T	18-5443
65 Cable Distribuidor a Bobina	1	84-817376T	205221
66 Kit Cables Bujias Distribuidor Elec. HEI	1	Para Tapa 18-5354 (84-816608Q71)	18-8836-1
66 Kit Cables Bujias Distr. Convencional	1	Para Tapas 18-5380/18-5395	18-8804-1
66 Kit Cables Bujias Distribuidor Elec. MPI	1	para Tapa 18-5244	18-8828-1
66 Kit Cables Bujias Distr. Convencional	1	para Tapa 18-5376	18-8802-1
78 Rotor (Encendido Electronico)	1	808484 1, 898253010, (Tapa 18-5354)	18-5405
78 Rotor (Encendido Elec. Redondo)	1	13524A5 (Tapas 18-5380/18-5395)	18-5431
78 Rotor (Encendido Mpi)	1	884790, 898253013, (Tapa 18-5244)	18-5245
78 Rotor Encendido Convencional	1	391-7057, 391-5088 (Tapa 185376)	18-5404-1
80 Modulo Encendido Distribuidor	1	811637001	18-5107-1
81 Tapa Distribuidor Electrónico HEI	1	para Distribuidor 18-5484	18-5354
81 Tapa Distribuidor Electrónico MPI	1	para Distribuidor 18-5351	18-5244
81 Tapa Distribuidor Convencional	1	para Distribuidor 18-5313	18-5376
81 Tapa Distribuidor Electrónico	1	para Distribuidor Redondo	18-5380/18-5395
88 Bobina Captador	1	811639, T (Para Distr. 18-5484)	18-5108
** Generacion IV Jta. Admisión Ovalada	1	Excepto H.O. (Fel-Pro 17240)	GMC4541900
** Generacion IV Jta. Admisión Rectangular	1	Excepto H.O. (Fel-Pro 17241)	GMC4541901
** Generacion V Jta. Admisión Ovalada	1	Excepto H.O. (Fel-Pro 17242)	GMC4541902
** Generacion V Jta. Admisión Rectangular	1	Excepto H.O. (Fel-Pro 17243)	GMC4541903
** Generacion V Omc	1	Excepto H.O. (Fel-Pro 17244)	GMC4541904
** Generacion V Omc	1	H.O. (Fel-Pro 17245)	GMC4541905
** Generacion IV Jta. Admisión Rectangular	1	H.O. (Fel-Pro 17246)	GMC4541906
** Generacion V EFI	1	(Fel-Pro 17280)	GMC4541907
** Generacion V	1	Excepto Efi (Fel-Pro 17249)	GMC5021900
** Generacion IV	1	(Fel-Pro 17248)	GMC5021901
** Generacion V EFI	1	(Fel-Pro 17281)	GMC5021902

Filtros Combustible

112401

Elimina la introducción de elementos sólidos en el carburador. Fabricado en plástico transparente para inspección para motores de gasolina desde 2000cc. Hasta 3500cc.



112406

Filtro recto para motores diésel de 2000cc. Hasta 3" Jcc. Fabricado en plástico transparente para su inspección.



112404

Filtro recto para motores diésel para más de 3500cc. Fabricado en plástico transparente para su inspección.



112403

Filtro 90° para motores diésel hasta 2000cc. Fabricado en plástico transparente para su inspección.



Filtros Separadores de Agua

Filtración 10 micras

508516

Mercury. Cabezal de aluminio



508517

Cabezal de aluminio



112405

Elimina la introducción de elementos sólidos en el carburador. Fabricado en plástico transparente para inspección. Filtro 90° para motores de gasolina hasta 2000cc.



112400

Elimina la introducción de elementos sólidos en el carburador. Fabricado en plástico transparente para inspección. Filtro recto para motores de gasolina hasta 2000cc.



112402

Filtro recto para motores diésel hasta 2000cc. Fabricado en plástico transparente para su inspección.



112397

Filtro recto para motores diésel hasta 1500cc. Fabricado en plástico transparente para su inspección.



508518

Yamaha. Cabezal de aluminio



508519

Mercury. Cabezal de aluminio





Kit Racors Manguera para Filtros

112411

Kit de 4 racors para manguera de 8mm.

112399

Kit de 4 racors para manguera de 10mm.



Vaso Recambio Filtros

Vaso de recambio para filtros ref. 112407 y Ref. 112412.

112409

Transparente.



Filtro Combustible

112412

Filtro para carburante de motores diésel, con doble vaso de decantación y tornillo de purga. Completo con cartucho intercambiable, para motores hasta 3.500cc. Capacidad máxima 50l./h.



Filtro Combustible

112407

Filtro para carburante de motores diésel, con vaso de decantación y tornillo de purga. Completo con cartucho intercambiable, para motores hasta 3.500cc. Capacidad máxima 50l./h.



Soporte Filtro

112408

Soporte para filtro Ref. 112407 en aluminio inyectado.



Filtro Combustible

112426

Kit de 2 rãcords giratorios para filtros Ref. 112423 para manguera de 8mm.



Filtro Combustible

Filtro para carburante de motores diésel, con vaso de decantación y tornillo de purga. Completo con cartucho intercambiable, para motores hasta 3.500cc. Soporte de aluminio inyectado. Capacidad máxima 50l./h.

112414

Filtro completo

112415

Cartucho de recambio.



Filtro Combustible

112425

Filtro decantador para motores de gasolina, con vaso transparente y tornillo de purga. Cuerpo de aluminio inyectado.



Filtro Combustible

112423

Filtro decantador para motores de gasolina, con red de nylon interior, vaso transparente y tornillo de purga. Cuerpo de aluminio inyectado.



Cartucho Recambio

112410

Cartuchos de recambio para filtros Ref. 112407 y Ref. 112412.



Bomba de Cebado

112422

Bomba manual de cebado para motores diésel. Completo con 2 entronques para mangueras de Ø10mm.

Abrazaderas Inoxidables Norma

Abrazaderas a tornillo sin fin. Fleje ancho anticortante de 12mm (excepto Ref. 016734, y Ref. 016735 con eje de 9mm). Tornillo inox. Con cabeza hexagonal ranurada de 7mm. Fabricados, totalmente, en **Acero inoxidable AISI 316. W5.**

Referencia	Ø	Referencia	Ø
016734	8-16mm	016740	50-70mm
016735	12-20mm	016741	60-80mm
016736	20-32mm	016742	70-90mm
016750	25-35mm	016743	90-110mm
016737	24-40mm	016744	110-130mm
016738	35-50mm	016745	140-160mm
016739	40-60mm		

Otras medidas superiores, bajo demanda.



Bujías Champion

Las bujías Champion cubre el 90% de aplicaciones del mercado con tan solo 10 referencias, tanto para intraborda como fuerabordas.

Llevan un aislador patentado de alúmina, endurecido con circonio para alcanzar una dureza casi tan alta como el diamante. Las cinco nervaduras incrementan la rigidez en un 35%, previene contra el "flashover" y aseguran una mejor sujeción del capuchón de la bujía.

El tipo de supresor de interferencias inductivo asegura la máxima energía de encendido entre los electrodos de la bujía y el tiempo de tensión más corto. Todo ello sin reducir la duración del arco. Garantiza la no interferencia del sistema de encendido ni con los componentes electrónicos del motor ni con los equipos de navegación.

Cuerpo metálico con triple protección que proporciona la máxima resistencia a la corrosión y actúa facilitando el desmontaje de las bujías después de un prolongado tiempo de servicio. Rosca de precisión conforme a todos los estándares ISO y SAE según las especificaciones de todos los fabricantes de motores, para facilitar la instalación y desmontaje de las bujías.

Ensamblaje con doble sellado.

Electrodo central de masa con núcleo de cobre.



Artículo Proveedor	Referencia	Artículo Proveedor	Referencia	Artículo Proveedor	Referencia
CJ6	050947	QC8WEP	050977	RL82C	050924
CJ7Y	050956	QL16V	050911	RL82YC	050952
CJ8	050950	QL6VC	050912	RL82YCC	050941
J4C	050901	QL76V	050913	RL86C	050925
J6C	050902	QL77JC4	050914	RL87YC	050963
J8C	050903	QL78C	050915	RN11YC4	050970
L20V	050904	QL78V	050916	RN2C	050959
L6VC	050934	QL78YC	050917	RN3C	050960
L76V	050905	QL78YC6	050962	RN5C	050951
L77JC4	050906	QL82C	050966	RN7YC	050979
L78C	050907	QL82YC	050918	RN9LCC	050942
L78V	050908	QL86C	050919	RN9YC	050948
L78YC	050933	QL87YC	050920	RN9YCC	050944
L78YC6	050923	QN53VS	050921	RS12PYP	050978
L82C	050937	QN86	050922	RS12YC	050949
L82YC	050909	R15YC4	050982	RS14YC6	050972
L86C	050910	RA8HC	050957	RS9YC	050955
L86CC	050953	RC10ECC	050961	RV12C6	050926
L87YC	050938	RC10YCC	050965	RV12YC	050927
N2C	050939	RC12ECC	050967	RV15YC4	050928
N3C	050940	RC15YC4	050981	RV8C	050929
N6YC	050936	RC7PYCBX/012	050975	RV91MC	050973
N9YC	050969	RC9YC	050943	RV9YC	050930
P10Y	050958	RF10C	050935	UL18V	050931
P8Y	050964	RJ12YC	050980	UL77V	050932
QC10WEP	050976	RJ8C	050945	V63C	050946
QC12PEP	050974	RL78C	050954	V63CST/003	050971

Bujías NGK

Las bujías NGK tienen un electrodo central con el núcleo de cobre insertado profundamente en la punta, para disipar rápidamente grandes cantidades de calor.

Esta característica hace que esta bujía sea de un “rango térmico ultralimpio”, que resiste tanto el calentamiento como la suciedad.

Incorpora un aislador producido con cerámica de alúmina de alta pureza de tecnología punta, resistiendo a los choques térmicos (calentamiento, y enfriamiento bruscos). Su sólida construcción, garantiza una excelente hermeticidad al gas.

La punta del electrodo está fabricada con una aleación especial de níquel que asegura su durabilidad.



Artículo Proveedor	Referencia	Artículo Proveedor	Referencia	Artículo Proveedor	Referencia
AB6	050800	BPR6FS	050700	DCPR6E	050859
B5ES	050801	BPR6HS	050827	DCPR7E	050894
B5HS	050802	BPR7ES	050828	DCPR8E	050873
B6ES	050803	BPR7HS	050829	DPR5EA-9	050896
B6HS	050804	BPR7HS-10	050843	DPR6EA9	050865
B7ES	050805	BPR8ES	050861	DPR6EB-9	050887
B7HS	050806	BPZ8HN-10	050870	DPR8EA-9	050848
B7HS-10	050807	BPZ8HS-10	050842	DR5HS	050852
B8ES	050808	BPZ8HS-15	050863	DR6HS	050851
B8HS	050809	BR4HS	050830	DR7EA	050824
B8HS-10	050810	BR5HS	050892	DR8EA	050868
B9ES	050811	BR6EF	050706	DR8ES	050849
B9HS	050812	BR6ES	050705	DR8HS	050834
B9HS-10	050813	BR6FIX	050711	DR9EA	050858
BKR6E	050823	BR6FS	050831	IMR9D9H	050891
BKR7EKU	050899	BPR2ES	050707	IZFR5G	050876
BM6A	050814	BR6HS-10	050880	IZFR6F11	050875
BM6F	050815	BR7ES	050847	LFR4E	050895
BM7A	050816	BR7HS	050853	LFR5A-11	050862
BM7F	050817	BR7HS-10	050832	LFR6A-11	050881
BMR4A	050841	BR8ES	050833	PMR9B	050701
BP5ES	050818	BR8ES-11	050882	PZFR5F-11	050846
BP5HS	050855	BR8HS	050854	PZFR6H	050886
BP6ES	050819	BR8HS-10	050835	TR4	050879
BP6HS	050820	BR9ES	050836	TR5	050708
BP7EFS	050856	BR9HS-10	050837	TR55	050877
BP7ES	050821	BU8H	050838	TR55IX	050888
BP7HS	050822	BUHW	050839	TR6IX	050710
BP8H-N-10	050871	BUHW-2	050840	UR4	050878
BP8HS-15	050869	BZ7HS-10	050885	YR5	050709
BPMR7A	050850	CR5EH-9	050890	YR5IX	050712
BPR4ES-11	050864	CR5HS	050883	ZFR4F11	050872
BPR5ES	050825	CR6HS	050845	ZFR5E	050867
BPR5HS	050874	CR6HSA	050889	ZFR7E	050866
BPR6EFS	050857	CR8 EH-9	050860	ZFR7F	050702
BPR6ES	050826	CR9EB	050884		

GENERATOR PRODUCTS

O.E. #	SIERRA #	O.E. #	SIERRA #	O.E. #	SIERRA #
FISCHER PANDA		NORTHERN LIGHTS		33417	23-0803
IC78.460.000A	23-1105	11-10015	23-0830	33966	23-0807
IC78.460.000B	23-1104	24-22009	23-1102	34093	23-2800
J009-1027B-1	23-3312	24-28003	23-1103	34113	23-2701
J009-46840	23-3311	25-12009	23-3315	34196	23-0802
JABSCO		25-12009	23-2005	34440	23-3307
22799-0001	23-2003	25-12031	23-0400	35109	23-5840
JOHNSON PUMP		ONAN		35595	23-7801
09-808B-1	23-2001	122-0185	23-7841	35608	23-2702
KOHLER		122-0810	23-7840	35610	23-2801
26987	23-7762	130-4434	23-6401	35736	23-3601
229432	23-0810	130-6228	23-6402	35828	23-7825
229433	23-0812	132-0349	23-3300	35920	23-7720
229678	23-7822	132-0436	23-3309	36450	23-7200
229715	23-7751	149-0428	23-7750	36918	23-7800
229826	23-2002	149-1445	23-7720	37387	23-3602
229826	23-3303	149-2106	23-7760	37922	23-0808
229955	23-3304	185-5835	23-7842	38100	23-7201
229963	23-0813	185-7444	23-7804	39181	23-4000
249433	23-7771	309-0130	23-3606	39378	23-3603
249865	23-0811	541-1519	23-3310	39705	23-1101
249930	23-3608	A026K278	23-7760	40154	23-7826
250872	23-2003	SHERWOOD		40434	23-0805
252896	23-3609	09000K	23-2002	40434	23-2700
252898	23-7740	10077K	23-2000	40859	23-2802
260085	23-6400	WESTERBEKE		40860	23-2804
267709	23-1100	11672	23-4001	42201	23-2804
267714	23-7823	11885	23-6400	42260	23-0800
267717	23-3610	11907	23-3301	43050	23-2803
267718	23-0809	13810	23-4005	43060	23-4500
278857	23-1130	24132	23-5880	45232	23-4003
279449	23-7820	24323	23-0806	46097	23-3604
326817	23-7803	24353	23-1000	46124	23-0801
352018	23-3607	24363	23-7764	46592	23-2703
352031	23-0814	24639	23-5800	46596	23-4501
352122	23-3308	24690	23-3605	46622	23-3306
359771	23-7821	26488	23-3600	47060	23-7770
359978	23-2004	30200	23-7770	48076	23-7802
359978	23-3314	30376	23-4007	24688 & 24323	23-3650
249930 & 29963	23-3664	30475	23-4004	24688 & 33966	23-3658
252896 & 229432	23-3665	30592	23-4002	24688 & 34196	23-3653
267717 & 267718	23-3663	30593	23-5600	24688 & 40434	23-3662
352018 & 352031	23-3666	30594	23-5900	24690 & 33373	23-3660
GM24510	23-7202	32620	23-3305	24690 & 33417	23-3657
GM32359	23-7761	33104	23-3313	35736 & 33417	23-3652
GM34570	23-7780	33112	23-3302	35736 & 34196	23-3651
GM47465	23-7824	33373	23-0804	35736 & 40434	23-3661
				37387 & 37922	23-3659
				39378 & 42260	23-3654
				39378 & 46124	23-3655
				46097 & 33417	23-3656

SIERRA MARINE PRODUCTS

O.E. #	SIERRA #	O.E. #	SIERRA #	O.E. #	SIERRA #
A.C. DELCO		20-0082-P	18-4364	CM206672JP	18-4360
GF-61	18-7856-1	20-0100	18-1907	FM-1-83	18-1996
GF-61P	18-7857-1	20-0100	18-1939	FM-1-83	18-1998-1
ARCTIC CAT		20-0102	18-1907	FM-1-83-P	18-4363
0436-879	72-5100-3	200087P	18-1992-1	MC 1 58759	18-1960-1
0436-880	72-5100-2	200089P	18-1991	MC 1 96705	18-1955-1
0436-901	72-5102-4	CHV-1-83	18-196	MC 1 99798	18-1956-3
1436-159	72-5102-2	CHV-1-83	18-1997-1	MC-1-65603	18-1962-1
1436-434	72-5101-2	CHV-47-000	18-2949	MC-1-65604	18-1958-1
1436-435	72-5101-3	CHVA-1-84	18-1898	MC-1-77234	18-1950-1
4639-349	72-5103-2	CM 20-0097	18-1949	MC-1-77235	18-1951-1
5639-469	72-5103-3	CM-1-6672-B	18-1941	MC-1-99746	18-1952-1
ARCTIC CAT PWC		CM-1-6672-H	18-1942	MC-20-44354	18-1976-2
3008-093	18-6919	CM-1-6677A	18-1940	MC-20-55538	18-1973
3008-327	18-6919	CM-1-6677SS P	18-8527	MC-20-60207	18-4008
3008-462	18-6919	CM-20-414211	18-1944	MC-20-76325	18-1972
3008-536	18-6919	CM-20-6672	18-1946	MC-20-76771	18-1978
BARR		CM-20-6674	18-1945	MC-20-93322A3	18-1985
160252	18-4009	CM-20-6674JP	18-8506	MC-20-98502	18-1974-1
01-0105	18-0476-1	CM-20-6674JP	18-8507	MC-20-98504	18-1970-2
01-0107	18-2854-1	CM-20-6674P	18-4361	MC-20-60426P	18-4362
1-73813	18-1990	CM-20-9232P	18-8518	OMC-1-914035	18-1986-1
20-0082	18-1999	CM-20-9234	18-1948	BORG-WARNER	
		CM-20-9234 P	18-8501	A4876HA	18-2590
				BOSCH	
				0-001-109-035	18-6944
				0331-302-050	18-5806
				0331-302-081	18-5806
				0331-302-085	18-5806
				0331-302-581	18-5806
				0331-302-585	18-5806
				BRP	
				5007987	18-8387
				420956741	18-8880
				CAN-AM	
				XPS #779139	72-5101-2
				XPS #779140	72-5101-3
				CATERPILLAR	
				3001117	18-6955
				10-258	18-6955
				163-3361	18-6944
				1R-0658	18-7880
				1R-0714	18-7927
				CERLIST DIESEL	
				1512903	18-7970
				1512904	18-7934

O.E. #	SIERRA #	O.E. #	SIERRA #	O.E. #	SIERRA #	O.E. #	SIERRA #
CHRIS-CRAFT				26-814669A1	18-2635	47-F84065	18-3085
1869704	18-5346	26-814669A2	18-2635	50-803900T	18-6441	F83404	18-7127
16.11-01236	18-2845	26-816464	18-8347	50-803903T	18-6439	F84068-2	18-3550
16.50-00074	18-0889	26-8164641	18-8347	50-819968	18-5618	F85068	18-3550
16.50-00078	18-0891	26-817472	18-0500	50-819968-2	18-5618	F85068-1	18-3550
16.50-00162	18-0874	26-819396	18-0502	50-8199681	18-5618	F85068-2	18-3550
16.50-00204	18-2946	26-820645A	18-2636	50-8199683	18-5618	F85955-1	18-5613
16.50-00232	18-0868	26-828627	18-8354	50-8199684	18-5618	F97068-2	18-3556
16.50-00250	18-3876	26-85090A1	18-2629	50-820193	18-5622	FA305310-2	18-5150
16.50-00259	18-3877	26-85090A2	18-2624	50-820193T1	18-5622	FA663260	18-39010
16.50-05756	18-0876	26-99325	18-0586	50-898265003	18-5618	FA85955	18-5613
16.61-00042	18-5911	26-F318307	18-0592	50-F514955	18-6441	FK10003	18-7033
16.69-00039	18-5314	26-F346118	18-0584	50-F575955	18-6439	FK10004	18-7037
16.69-00040	18-5338	26-F40307-2	18-0503	700-834794A4	18-4630	FK10005	18-7037
16.69-00042	18-5411	26-F84307-1	18-0512	700-834794A5	18-4631	FK10007	18-7037
16.69-00049	18-5311	26-F901307-2	18-0593	700-834794T3	18-4629	FK10008	18-7037
16.69-00050	18-5345	27-19701	18-0622	700-834800A4	18-4632	FK10026	18-7033
16.69-00051	18-5418	27-819138-2	18-3859	700-834800A5	18-4632	FK10027	18-7037
16.69-00052	18-5385	27-819377	18-0873	700-834800A6	18-4633	FK10053	18-7033
16.69-00100	18-5375	27-820438	18-3855	815279T2	18-4634	FK10057	18-7037
16.69-00148	18-5376	27-820500A3	18-0869	815279T3	18-5742	FK10102-1	18-7033
16.69-00149	18-5404-1	27-824615	18-3857	815279T4	18-5742	FK10108	18-7037
16.69-0022	18-5427	27-824615-2	18-3857	815279T5	18-5744	FK1060	18-2630
16.81-06536	18-7875	27-828316	18-0314	817764A2	18-5744	FK1061	18-2631
16.81-08746	18-7824-2	27-F178168	18-0314	818903A1	18-5150	FK1063-1	18-2632
16.83-08758	18-7265	27-F178168-1	18-0314	819479A1	18-6777	FK1063-2	18-2632
16.83-90006	18-7860	27-F201529-1	18-3856	819480A1	18-6777	FK1064	18-2637-1
FI6900165	18-5375	27-F286529-3	18-3851	819762A4	18-6777	FK1065	18-2638
FI8308762	18-7265	27-F307279-2	18-0115	819762A7	18-6777	FK1068	18-2639
CHRYSLER FORCE				27-F372154-1	18-0958	81977A8	18-6777
75384	18-5697	27-F40223	18-0869	81977A9	18-6777	FK1074	18-2636
455541	18-6762	27-F40279-1	18-0154	822870A1	18-6777	FK1127	18-2633
811902	18-5677	27-F406406	18-0915	827675A1	18-6777	FK1203	18-2640
817411	18-5742	27-F440906	18-0315	830179A1	18-6286	FK1234	18-2635
819222	18-5673	27-F476067	18-0854	830179A2	18-5744	FK616955	18-5613
820545	18-6279	27-F476529-4	18-3857	830250A3	18-5742	F010790	18-7041
824051	18-6775	27-F481836	18-0152	830250T3	18-6777	F016311	18-7041
1736073	18-7264	27-F513529	18-3852	832021A1	18-6777	FP2437A	18-5149
2279913	18-7264	27-F523031	18-0415	832021A2	18-6777	FRK739	18-7037
3745414	18-7254	27-F658529	18-3854	832021T2	18-6777	FS409752	18-8011EP-2
3745415	18-7255	27-F691529-1	18-3853	832021T4	18-6777	FS438955	18-5613
8152792	18-5742	27-F694830	18-0416	854514A1	18-5744	FS438955	18-5613
8152794	18-5744	27-F84031	18-0417	855654A1	18-6777	FS480955	18-5613
8174111	18-5744	27-F85154-1	18-0119	855654T2	18-6777	FS489955	18-5613
11-35921	18-3719	27-F85168-2	18-0855	856747T1	18-5744	FS490955	18-5613
11-47411	18-3719	27-F85748-2	18-0861	883071A1	18-5744	L-319	18-7879-1
11-826375	18-3719	27-F85762	18-0141	89-803822T	18-5835	CHRYSLER INBOARD	
11-F694188	18-3719	27-F85906	18-0960	89-817109A2	18-5834	10612	18-0499
18495A26	18-5790	27-F97067	18-0873	89-817109A3	18-5835	10927	18-3168
19217A1	18-6777	31-F523143	18-1113	89-F460917-1	18-5835	56874	18-7875
19217A5	18-6777	31-F523901	18-1112	F010790	18-7057	200691	18-5435
19291A3	18-2370	332-5772A5	18-5881	F12042-1	18-5169	201522	18-5433
197787-3	18-8062	332-5772A7	18-5881	F12044	18-5149	868095	18-5430
21-42990A10	18-7817	332-7778A12	18-5775	F12181-1	18-5149	868096	18-5404-1
21-42990A7	18-7817	339-7370A13	18-5186	F15100	18-5241	1274092	18-5307
21-42990A8	18-7817	339-7370B13	18-5186	F15110	18-5673	1658535	18-5407
21-42990A9	18-7817	339-832757B4	18-5186	F15150	18-5673	1692658	18-5841
21-857005A1	18-7817	39-817869A1	18-39010	F15164	18-5697	1736073	18-7264
25-20195	18-7134	39-820457A2	18-3998	F177917	18-5803	1818757	18-5347
25-201951	18-7134	39-820641A1	18-3999	F178168	18-0314	1851658	18-7875
25-32507	18-7127	398-176	18-5206	F184122-1	18-2534	2084074	18-5307
25-45258	18-7950	398-832075A4	18-5870	F24747-1	18-7805	2095946	18-5723
25-85549	18-7956	398-832075A6	18-5873	F335068	18-3557	2098058	18-5345
25-85594	18-7100	44-850308	18-2254	F438955-1	18-5613	2098300	18-5710
25-88657	18-7952	449541-3	18-6762	F460917-1	18-5835	2098611	18-5429
25-F24278	18-7169	46-43024A7	18-3214	F476529	18-3857	2279913	18-7264
25-F45530	18-7457	47-19453	18-8900	F476529-1	18-3857	2279949	18-5345
25-F498618	18-7120	47-42038-2	18-3062	F476529-2	18-3857	2421173	18-5303
25-F74305	18-7176	47-430262	18-3056	F480955	18-5613	2421178	18-5307
25-F84305	18-7127	47-803630T	18-3030	F490955	18-5613	2421820	18-5314
26-41131	18-0579	47-803631T	18-3017	F523065	18-3030	2463441	18-3645
26-41132	18-0580	47-85089-3	18-3057	F523065-1	18-3030	2469556	18-1913
26-41365A3	18-2697-1	47-89984T4	18-3017	F528068	18-3559	2469559	18-2941
26-43035	18-0583	47-F40065-2	18-3084	F616955	18-5613	2469639	18-1913
26-43035A4	18-2626	47-F433065	18-45003	F694541-1	18-6279	2495531	18-5433
26-66022	18-0584	47-F436065-2	18-8903	F697140	18-3200	2808870	18-5303
26-76384	18-8347	47-F462065	18-8901	F718470	18-5742	2846106	18-1941
		47-F694065	18-3017	F746470	18-5742	2846689	18-1945

O.E. #	SIERRA #	O.E. #	SIERRA #	O.E. #	SIERRA #	O.E. #	SIERRA #			
2847404	18-1944	38071	18-5405	7243200	18-5443	S114-257G	18-6880			
2847405	18-1913	40057	18-3169	9002514	18-7875	S114-303	18-6937			
2847480	18-2941	41052	18-5369	R130012	18-15214	S114-303A	18-6937			
2847527	18-5710	41057	18-5345	RO29015	18-1938	S114-483	18-6880			
2847623	18-1944	41058	18-5303	RP061022	18-8926	S114-483A	18-6880			
3004886	18-3581	41059	18-5407	CUMMINS				S114-559B	18-6861	
3420600	18-5347	41061	18-5399	160596	18-3078	S114-682	18-6942			
3527501	18-5954	41069	18-5353	166758	18-3078	S114-837	18-6831			
3527502	18-5954	41074	18-5403	214169	18-6952	S114-837A	18-6831			
3527794	18-1946	41076	18-5352	216040	18-5982	S13-68	18-6934			
3549957	18-7878-1	41080	18-5435	556540	18-3078	S13-68A	18-6934			
3619542	18-3581	41089	18-5403	556850	18-3078	S13-68C	18-6934			
3619859	18-3582	42001	18-5717	650607	18-3077	S13-86	18-6934			
3656017	18-5102	42090	18-5907	3920618	18-6952	HONDA				
3675826	18-1940	42091	18-5908	21601R	18-3078	06192-881-C00	18-3279			
3675826	18-1942	45303	18-7200	3603853RX	18-6952	06192-ZV1-C00	18-3278			
3744870	18-5954	45334	18-7095	3604234RX	18-5982	06192-ZV4-000	18-3280			
3745215	18-28019	47002	18-7600	DELCO				06192-ZV4-A00	18-4536	
3745217	18-0607	47032	18-7630	1100077	18-6952	06192-ZV5-003	18-3282			
3745220	18-4346	47033	18-7632-1	1100093	18-6952	06192-ZV7-000	18-3281			
3745414	18-7254	47047	18-7958	1100211	18-6952	06192-ZW1-000	18-3283			
3745415	18-7255	51080	18-5433	1100274	18-6952	06192-ZW1-305	18-3187			
3745639	18-1944	91351	18-2845	1105474	18-6952	06192-ZW1-B04	18-3492			
3745985	18-3581	91606	18-7862	1105475	18-6952	06192-ZW9-000	18-3493			
3780600	18-5103	96108	18-0305-1	1105476	18-6952	06192-ZW9-A30	18-3478			
3874020	18-5105	96120	18-1925	1114356	18-5838	06192-ZX2-C00	18-3489			
3874767	18-5451	96121	18-1926	1114458	18-5838	06192-ZY3-000	18-3285			
4106140	18-5450	96216	18-0306-1	1115202	18-5433	06192-ZY6-000	18-3284			
4142322	18-1940	96306	18-2949	10459244	18-6952	08208-0080	72-5102-2			
4142408	18-5369	96319	18-3551	DENSO				15400-PFB-007	18-7911-1	
4142817	18-5352	96358	18-3552	995435	18-6868	15400-PFB-014	18-7913			
4142880	18-3860	96562	18-0309-1	101211-3020	18-6960	15400-PLM-A01PE	18-7909			
4142885	18-3551	96653	18-0418	101211-3021	18-6960	15400-POH-305	18-7909			
4142886	18-7230	96938	18-2434	101211-3460	18-6844	15400-POH-305PE	18-7909			
4273129	18-0609	97039	18-7272	101211-9940	18-6849	15400-ZJI-004	18-7909			
4417375	18-3878	97114	18-1929	128000-4860	18-6868	16010-881-003	18-2482			
4417905	18-3581	97115	18-1933	128000-4861	18-6868	16010-ST5-993	18-7785			
24695566	18-1942	97169	18-1916	128000-4862	18-6868	16010-ZV4-005	18-2480			
118-614	18-0956-1	97214	18-7231	128000-4863	18-6868	16010-ZW9-003	18-2481			
7087-OR	18-7512	97296	18-1917	128000-4864	18-6868	16011-881-741	18-7048			
E9234M	18-1948	97361	18-3671	128000-4864	18-6868	16011-ZV4-005	18-7047			
E9923M	18-1944	97386	18-1918	228000-4550	18-6867	16176-POA-004	18-0737			
F724002	18-7875	97387	18-1919	428000-0081	18-6873	16201-881-850	18-2473			
L-1008	18-7878-1	97498	18-2909	DETROIT DIESEL				16221-ZV4-610	18-2470	
L-19	18-7878-1	97595	18-7231	5574508	ELECTROLUX				16221-ZW1-000	18-2472
CRUSADER				5574508	EVINRUDE				16221-ZW9-000	18-2471
12525	18-5310	97624	18-1924	FRAM				16900-SA5-004	18-7786	
12526	18-5344	97686	18-0311	GLM				16900-SR3-004	18-7720	
12528	18-5384	97752	18-1925	GM				16901-ZY3-003	18-79909	
12530	18-5338	97753	18-1926	5024/120	18-6758	16910-GB2-005	18-7712			
12531	18-5411	97772	18-1927	KS3448/290	18-6790	16910-ZV4-015	18-8226			
12532	18-5375	97854	18-8112	HITACHI				16910-ZVL-003	18-7521	
20117	18-5411	97895	18-3649	3701777	18-2917	16911-ZY3-010	18-79908			
20129	18-5375	97924	18-3649	6269358	18-3577-2	16977-ZV5-900	18-80406			
20117	18-5314	97924	18-1928	6269577	18-3876	16977-ZV5-A00	18-80400			
20129	18-0976	97992	18-1929	6414989	18-7258	17105-ZY3-004	18-0390			
20222	18-0976	97993	18-1933	10482803	18-5117	17105-ZY6-000	18-0300			
20222	18-5376	97993	18-1933	14077948	18-4173	17109-XY6-000	18-0382			
20223	18-5404-1	98041	18-7846	14077949	18-4164	17109-ZY3-004	18-0396			
20300	18-3061	98068	18-1934	14089025	18-3937	17151-ZW5-00	18-0248			
20309	18-3168	98125	18-1982	14089026	18-3938	17650-921-003ZB	18-80420			
20318	18-3599-2	98126	18-1938	14089026	18-3938	17650-ZW9-003	18-80408			
20502	18-3140	98128	18-1984	HITACHI				17660-ZV5-902	18-38008	
21140	18-7270	201104	18-7824-2	129470-77200	18-6929	17670-ZW1-030GH	18-7947			
21141	18-7271	201104	18-7876-1	LR135-105	18-6925	17670-ZW1-801AH	18-7948			
22212	18-3060	700425	18-5899	LR135-74	18-6928	17700-ZW9-010	18-81042EP-2			
22687	18-7852-1	700427	18-5898	LR135-74B	18-6928	17700-ZW9-020	18-81042EP-2			
23250	18-7976	705786	18-5427	LR180-03A	18-6929	17710-ZW9-033	18-80407			
30103	18-3577-2	705787	18-5345	LR180-03B	18-6929	19021-ZW1-003	18-3214			
30266	18-3877	705788	18-5307	LR180-03C	18-6929	19210-881-A01	18-3245			
31136	18-3887	707125	18-5717	S114-257	18-6880	19210-881-A02	18-3245			
31137	18-3874	1003026	18-3060	HITACHI				19210-ZV4-013	18-3246	
32722	18-7256	1003062	18-3046	LR135-105	18-6925	19210-ZV4-651	18-3246			
33393	18-4408	1003317	18-5375	LR135-74	18-6928	19210-ZV4-651	18-3247			
33408	18-3879	1003318	18-5411	LR135-74B	18-6928	19210-ZV5-003	18-3248			
33628	18-7232	3000121	18-5389	LR180-03A	18-6929	19210-ZV7-003	18-3249			
37061	18-5313-1	3000122	18-5420	LR180-03B	18-6929	19210-ZW1-003	18-3056			
37068	18-5433	3000124	18-5318	LR180-03C	18-6929					
37068	18-5438	7057500	18-3876							
38070	18-5354	7142520	18-3599-2							
		7243110	18-5107-1							

O.E. #	SIERRA #	O.E. #	SIERRA #	O.E. #	SIERRA #	O.E. #	SIERRA #
HONDA cont.				JOHNSON PUMP			
19210-ZW1-B04	18-3250	91301-ZG3-000	18-71335	01-42401	18-3303	4140M	18-34140
19210-ZW9-003	18-3100	91353-ZW1-003	18-7198	09-1026B	18-3080	5110MFI	18-34120
19210-ZW9-013	18-3100	91356-ZY3-003	18-8299	09-1026B-1	18-3080	9-26103	18-5339-1
19210-ZW9-A02	18-3245	HP2	72-5103-2	09-1026B-9	18-3036	9-29418	18-5397
19210-ZW9-A31	18-32455	HP2	72-5103-3	09-1026B-9	18-3080	9-34081	18-7489
19210-ZW9-A32	18-32455	HP2	72-5103-4	09-1026B-9	18-3080	9-72152	18-2163E-9
19210-ZY3-003	18-3031	HP2	72-5103-5	09-1026B-9	18-3080	YL512CV	18-5309-1
19231-ZW1-003	18-3122	HP2	72-5103-7	09-1027B	18-3081	YL554CV	18-5312-1
19232-881-850	18-2608	HP4	72-5100-2	09-1027B-9	18-3020	YL566AV	18-5339-1
19232-ZV1-A10	18-2524	HONDA PWC		09-1028B	18-3077	YL567EV	18-26104-1
19232-ZV4-610	18-2495	31200-HW1-671	18-6877	09-1028B-9	18-3038	YL579AV	18-26110-1
19232-ZW1-003	18-2563	ILMOR		09-1029B	18-3078	YL624AV	18-5313-1
19232-ZW9-000	18-99153	MV8V1021	18-57824	09-1029B-9	18-3037	YL624BV	18-5316-1
19233-ZV5-000	18-2496	S556162	18-32152	09-1022B	18-3277	YL624MMW	18-5313-1
19234-881-850	18-2609	ILMOR / MASTERCRAFT		09-45589	18-3076	YL648AV	18-26111-1
19234-ZW1-003	18-2564	550022689	18-9558-2	09-45589	18-3510	YL673AV	18-5315-1
19234-ZW1-003	18-2564-1	550046126	18-9558-4	09-45825	18-3089	YL700AV	18-26107-1
19234-ZW1-B00	18-0481	INDMAR		09-801B	18-3075	YLM512CV	18-5495-2
19234-ZX2-C00	18-99154	573001	18-5603-1	09-802-B	18-3304	YLM554CV	18-5489-2
19234-ZY3-000	18-2499	575010	18-6288	09-806B	18-3079	YLM566AV	18-26311-2
19242-ZV5-000	18-0176	575011	18-5984	09-808B	18-3076	YLM567CV	18-5496-2
19242-ZW1-003	18-2565	575014	18-6451	09-810B	18-45713	YLM624BV	18-5498-2
19242-ZW1-B00	18-0482	685001	18-3587-1	09-812B	18-3306	YLM673AV	18-5486-2
19300-881-741	18-3629	685011	18-3586-1	09-819B	18-3275	YLM673AV	18-5486-2
19300-881-761	18-3627	751007	18-5303	09814B	18-45712	YLM676AV	18-5487-2
19300-ZV5-043	18-3630	755017	18-5345	10-24228-1	18-3586-1	YLM700AV	18-26310-2
19300-ZW9-003	18-3628-1	755021	18-5277	10-24232-1	18-3587-1	MANDO	
30520-PNA-007	18-7494	872003	18-9555-2	3298-0000	18-3125	A000B0341	18-6843
30520-PWC-003	18-23251	872005	18-9554-2	JOHNSON/EVINRUDE		TA000B0341	18-6843
30530-P8F-A01	18-7559	872006	18-9554-4	302035	18-71336	MARINE POWER	
30530-PPL-A01	18-7558	872025	18-8779	302325	18-1597	402001	18-6299
31200-ZV5-013	18-6433	0170-000	18-5603	321129	18-1827	612011	18-1985
31200-ZW1-004	18-15061	50-1001	18-7824-2	324640	18-4578	0100-000	18-2434
31200-ZW9-802	18-6445	501022S	18-8623	324641	18-4551	0170-000	18-5603-1
31200-ZY6-003	18-6959	53-2009	18-1907	325040	18-99156	0991-110	18-1898
31200-ZY9-003	18-6959	53-2018	18-1907	328725	18-1596	0992-593	18-1939
31200-ZY9A-0031	18-6959	872004 (7QT)	18-9555-4	328754	18-2147	0994-000	18-8536
31630-ZW5-003	18-6475	S525009	18-31104	331130	18-3026	50-808011A4	18-5603
31630-ZY6-003	18-6476	S556003	18-7976	331894	18-3566	MARINER	
35655-ZY3-013	18-7657	S556050	18-42608	338485	18-4579	27-99049M	18-74501
35655-ZY3-C01	18-32153	S556162	18-32152	338486	18-4549	MCCULLOCH	
35655-ZY6-013	18-7659	S985009	18-43017	338601	18-1826	1340135	18-5153
35655-ZY9-003	18-7658	JABSCO		339720	18-4569	36550135	18-5153
35655-ZZ5-004	18-32153	1210-0001	18-3081	340811	18-1825	38850115	18-5241
36120-ZV5-821	18-6258	1210-0003	18-3020	342370	18-1825	75101A	18-5153
36120-ZV5-822	18-6793	124310-46090	18-3075	346865	18-71340	MERC / EVINRUDE	
36120-ZY3-023	18-6742	13554-0001	18-3306	349354	18-71338	881150K1	18-9895
36120-ZY6-013	18-6745	14510-46090	18-3075	353690	18-1824	MERCUISER	
36120-ZY9-003	18-6743	17636-0001	18-45712	354578	18-1824	13220	18-7751
37500-PNB-003	18-25200	17935-0001	18-3275	354580	18-1822	56045	18-6841
37510-PNB-003	18-25201	17937-0003	18-3038	355169	18-5701	56045	18-6842
37830-PGK-A01	18-7552	18653-0001	18-45713	355209	18-5703	59755	18-6841
41107-ZV5-00-00	18-6165A	18838-0001	18-3046	360347	18-4571	59755	18-6842
41107-ZW1-003ZA	18-6011	18838-0001	18-3060	586768	18-6826	69729	18-6841
41107-ZW1-003ZA	18-6011A	18948-0001	18-3047	5005034	Lhuston	69729	18-6842
41107-ZW1-003ZA	18-6241	18948-0001	18-3061	5005831	18-6815	78385	18-5724
41109-ZW1-003	18-6068	21676-0001	18-45712	5007554	18-4568	78477	18-6841
90508-ZW1-003	18-3200	22405-0001	18-3076	5007770	18-1823	78477	18-6842
90752-ZV4-650	18-3268	2877-0001	18-3075	5008967	18-4539	90794	18-6841
90752-ZV5-003	18-3270	3101-0000	18-3125	KAWASAKI		90794	18-6842
90752-ZV7-000	18-3269	4528-0001	18-3079	21163-3715	18-6873	821663	18-6960
90752-ZW1-B02	18-3271	4568-0001	18-3075	21163-3719	18-6873	834832	18-6844
90752-ZW9-A30	18-3022	4598-0001	18-3021	21163-3720	18-6904	8216631	18-6960
90752-ZW9-A30	18-3025	673-0001	18-3080	21174-3703	18-6875	11-88462	18-2460
90752-ZY3-003	18-3273	673-0003	18-3036	K61021-208A	72-5103-2	1389-815396A2	18-7370N
91051-ZW1-003	18-1156	6760-0001	18-3304	MALIBU		1389-8490A2	18-7370N
91053-ZW1-003	18-1158	836-0001	18-3078	S556162	18-32152	1389-9350A2	18-7370N
91057-ZW1-003	18-1157	836-0003	18-3037	MALLORY		1389-9562A1	18-7370N
91251-ZW1-003	18-0583	920-0001	18-3077	670	18-26800	14336A15	18-6747
91251-ZW1-B04	18-1820	920-0003	18-3038	5421	18-35101	14336A15	18-6813
91252-935-004	18-8298	92700-0060	18-2005	29349	18-26815	14336A17	18-6747
91252-ZV1-003	18-3288	JOHNSON		29716	18-29716	14336A20	18-6813
91252-ZW1-003	18-2002	5036972	18-6945	54212	18-35102	14336A22	18-6747
91253-ZW1-003	18-2054			29440M	18-29720	14336A28	18-6747
91254-ZW1-003	18-0522			4110M	18-34110	14336A6	18-6747
91255-ZW1-003	18-2053						

O.E. #	SIERRA #	O.E. #	SIERRA #	O.E. #	SIERRA #	O.E. #	SIERRA #
14336A6	18-6813	10-28668	18-3229	12-20260	18-2945		
14336A8	18-6813	10-30206	18-2361	12-22388	18-4275	17-45735	18-2152
14336A9	18-6747	10-30720	18-3226	12-23245	18-2948	17-45738	18-2151
14336A9	18-6813	10-31700	18-2163	12-25410	18-0203	17-815953	18-2395
22-88847A1	18-2460	10-31700	18-2163E-9	12-25945	18-4275	17-815953A1	18-2395
26-11973	18-1213	10-32470	18-6245	12-29245	18-4275	17-815953T1	18-2464
26-42750	18-1213	10-36289	18-3729	12-29395	18-4267	17-828507 1	18-15129
26-54799	18-1213	10-43749	18-8410	12-31060	18-7180	17-85056	18-2462
26-97335	18-1213	10-44387	18-8411	12-31211	18-3714	17-8M0020941	18-2357
27-75611A03	18-1254	10-45590	18-2170	12-31211A2	18-3714	17-8M0084681	18-2357
27-864547A02	18-0721	10-67373	18-3197	12-31211A3	18-3714	17-8M0100263	18-2357
27-864547A1	18-0721	10-76156	18-3197	12-31211Q03	18-3714	17-99207	18-2463
27-864547A1	18-0722	10-79953	18-2244	12-31266	18-2340	18-52457	18-2848
27-864549A02	18-0720	10-79953A2	18-2244	12-32733	18-4275	18-524571	18-2848
27-864549A1	18-0720	10-79953Q04	18-2244	12-32834	18-0681	19-14842	18-2465-9
27-864850A02	18-0722	10-79953Q2	18-2244	12-34961	18-9805	19-148421	18-2465-9
30-803097T1	18-8213	10-8053432	18-8402	12-35935	18-0203	19-32652	18-4272
30-803098T1	18-8217	10-8053432	18-8402-1	12-36001	18-4270	19-42682	18-4273
30-803099T1	18-8218	10-805763	18-2361	12-38753	18-4275	19-47579	18-3232
30-803100T1	18-8219	10-8083434	18-8404-1	12-45176	18-4858-9	19-475791	18-3232
3310-806077A2	18-7370N	10-816601	18-3230	12-45810	18-3712	19-815951	18-2466-9
3310-806078A2	18-7370N	10-853163	18-2361	12-49221	18-2948	21-42990A10	18-7817
3310-860070A2	18-7370N	10-86801	18-1706	12-492211	18-2948	21-42990A7	18-7817
3310-861245A1	18-7376N	10-8M0084649	18-2170	12-77674	18-2316	21-42990A8	18-7817
3310-861448A1	18-7375N	10-97934	18-3729	12-77987	18-4220	21-42990A9	18-7817
3310-861448A1	18-7375N	10-97934A1	18-2141	12-77987A1	18-4220	21-806118	18-33800
3310-864941A01	18-7373N	10-98794	18-3231	12-815472	18-0318	21-857005A1	18-7817
3310-864942A01	18-7375N	10-F50109	18-2244	12-824793	18-4275	22-13563A3	18-8076
3310-864943A01	18-7376N	11-13439-1	18-3721	12-835467	18-4220	22-13563A6	18-8091
392-863704T	18-5465	11-20361	18-3722	12-8354671	18-4220	22-13563A7	18-8091
46-807151A12	18-36001	11-21298	18-3721	12-835467Q01	18-4220	22-13563Q3	18-8076
50-60594A	18-6824	11-22178	18-3721	12-855682-2	18-9078	22-13563Q7	18-8091
50-60594A1	18-6824	11-22339	18-3713	12-86645	18-2560	22-13563T3	18-80410-1
50-60594T01	18-6824	11-24648	18-3721	12-866451	18-2560	22-13563T7	18-8091
50-801333980	18-6957	11-29241	18-3721	12-88263	18-1186	22-14213M	18-8075
50-805991	18-6947	11-33962	18-3721	12-8M0042641	18-4267	22-14213Q	18-8075
50-831001562	18-6949	11-34932	18-3720	12-8M2001219	18-0681	22-16610M	18-8084
50-831001961	18-6949	11-34933	18-3721	12-92647M	18-4233	22-16951A1	18-4218
50-854178	18-6957	11-35888	18-3722	12-92721	18-2343	22-16951Q1	18-4218
50-855507	18-6957	11-35921	18-3719	12-93416	18-0681	22-16951T1	18-4218
50-8M8021116	18-6946	11-36084	18-3713	12-934161	18-0681	22-22175	18-7413
65L-13915-00-00	18-79901	11-39823	18-3785	13-888363-2	18-9077	22-30139	18-4263
78403A1	18-6841	11-39907	18-3785	14-17460	18-2298	22-32802	18-4263
78403A1	18-6842	11-42633	18-2346	14-18323	18-2298	22-328021	18-4263
78403A2	18-6841	11-45592	18-3723	14-31210	18-3200	22-328022	18-4263
78403A2	18-6842	11-46355	18-3721	14-34817	18-3788-9	22-32803	18-4264
807252Q4	18-3668	11-47411	18-3719	14-52833	18-2299	22-33198	18-4258
821663A1	18-6960	11-52707	18-3700	14-76281	18-3204	22-33198A1	18-4258
834832T2	18-6844	11-52707A1	18-3701	14-79447	18-2299	22-36305	18-8216
857006A3	18-6844	11-52707A2	18-3701	14-816629	18-3200	22-36305T	18-8216
864308T01	18-1843	11-52707Q1	18-3701	14-816629Q	18-3200	22-36392	18-8111
864591T02	18-1845	11-54034	18-3785	14-F697140	18-3200	22-41622	18-4258
865049T01	18-1843	11-69578	18-3704	15-23097A1	18-2293	22-41622	18-4258
865380A02	18-6747	11-69578A1	18-3702	15-31535A1	18-2284	22-424254	18-8958
865380A05	18-6747	11-69578Q1	18-3702	15-32563A1	18-2282	22-42861	18-4265
865380A13	18-6813	11-69578T1	18-3702	15-33143A1	18-2295	22-428611	18-4265
865380A15	18-6747	11-805092	18-3783	15-35931A1	18-2285	22-46754	18-4258
865380A25	18-6747	11-805092T	18-3783	15-35980A1	18-2292	22-63186	18-8054
865735A02	18-1843	11-805093	18-3786	15-36178A02	18-2293	22-63187	18-8055
88183A12	18-6747	11-826375	18-3719	15-36178A1	18-2293	22-64426	18-4218
88183A12	18-6813	11-8267089	18-3722	15-39899A1	18-2293	22-67892	18-2375
88183A3	18-6747	11-82671015	18-3721	15-42637A1	18-2294	22-67892A05	18-2375
88183A5	18-6813	11-82671127	18-3785	15-45691A1	18-2283	22-67892A06	18-2375
88183A8	18-6813	11-827614	18-3700	15-45811	18-2296	22-67892A1	18-2375
8M0054588	18-5465	11-859116	18-3721	15-47397A1	18-2285	22-67892A1	18-23751-9
92-802837Q1	18-9400-2P	11-859131	18-3783	15-57007A1	18-2295	22-806608A02	18-4226
92-802841A1	18-9400-7P	11-862907	18-3786	15-71013	18-2296	22-806608A1	18-4226
92-857389A1	18-9400-4P	11-863332	18-3728	15-8M0063267	18-2294	22-806926	18-4227
92-858057K01	18-9440-7P	11-88228	18-3703	17-14872	18-2393	22-806926A1	18-4224
		11-95702	18-3721	17-14872A1	18-2463	22-807155	18-4461
		11-97522	18-3713	17-14873	18-2394	22-81042M	18-8075
		11-99298	18-3728	17-14873A1	18-2462	22-816856T2	18-80412
10-14834	18-2375	11-F694188	18-3719	17-30632	18-2357	22-818994	18-8957
10-14834A1	18-2375	12-12577	18-1191	17-35973	18-3227-9	22-8189941	18-8957
10-14834A1	18-23751-9	12-13171	18-4220	17-44166	18-2396	22-841908	18-4263
10-20259	18-2244	12-19183	18-2945	17-44166T1	18-2461	22-861187	18-4265
10-20518	18-2303	12-191832	18-2945	17-44167	18-2397	22-862210	18-4227
10-28634	18-2244	12-191833	18-2945	17-44167A1	18-2397	22-862210A01	18-4224
10-28634A1	18-2244						

MERCURY MARINE

O.E. #	SIERRA #	O.E. #	SIERRA #	O.E. #	SIERRA #	O.E. #	SIERRA #
MERCURY MARINE cont.		23-818471001	18-1316	25-35480	18-7411	26-58094	18-4023
22-87238	18-4218	23-853853	18-1148	25-35984	18-7169	26-58203	18-1211
22-87543	18-4264	23-853853002	18-1148	25-36318	18-7440-1	26-62818	18-0529
22-8M0001721	18-8956	23-853853A1	18-1148	25-36390	18-7410	26-66022	18-0584
23-11992	18-1327	23-85669	18-1317	25-38933	18-7120	26-66303	18-0595
23-11992001	18-1327	23-85677	18-1329	25-39572	18-7151	26-66303A1	18-2627
23-15960	18-1300	23-85684	18-1305	25-39695	18-7464	26-67388	18-0578
23-15961	18-1308	23-85691	18-1333	25-45254	18-7166	26-67863	18-4022
23-1596110	18-1309	23-85698	18-1300	25-45710	18-7198	26-69188	18-2051
23-1596120	18-1341	23-85701	18-1308	25-45711	18-7174	26-69189	18-2052
23-1761515	18-0208	23-85704	18-1309	25-47254	18-7961	26-70019	18-2002
23-1761516	18-0210	23-85705	18-1341	25-47386	18-7411	26-70081	18-2053
23-1761517	18-0212	23-85715	18-1317	25-47632	18-7146	26-72564	18-0518
23-1761518	18-0214	23-85718	18-1316	25-48171	18-7168	26-72564	18-4023
23-1761519	18-0216	23-85726	18-1334	25-48451	18-7159	26-72785	18-0531
23-1761520	18-0218	23-85726001	18-1334	25-53421	18-7177	26-75413	18-0518
23-1761522	18-0222	23-888690	18-9075	25-54029	18-0858	26-75413	18-4023
23-1761523	18-0224	23-888690-1	18-9076	25-54030	18-7467	26-75624	18-0518
23-1761524	18-0226	23-89574	18-2701	25-55801	18-7445	26-75624	18-4023
23-1761526	18-0230	23-89574	18-2701-04	25-59712	18-7177	26-75982	18-4022
23-29804	18-3109	23-90203	18-2336	25-60342A1	18-2291	26-75988	18-4022
23-29804T	18-3109	23-99291	18-2702-04	25-60342A2	18-2291	26-76384	18-2054
23-30617A1	18-2154	23-99291T	18-2702-1	25-62384	18-7414	26-76384	18-8347
23-30617A2	18-2154	23-99291T	18-2702-04	25-62700	18-0860	26-76868	18-2002
23-32632	18-3236	23-99291T	18-2702-1	25-62702	18-7413	26-76868A04	18-2645
23-34464	18-1317	24-17057A1	18-1234	25-62704	18-7116	26-76868A1	18-2645
23-37428A1	18-2155	24-17997A1	18-2715	25-62705	18-7105	26-76868A2	18-2645
23-43045	18-0568-9	24-29340A1	18-6506	25-62706	18-7102	26-77066A1	18-2628
23-43293	18-1339	24-29340T1	18-6506	25-62817	18-7175	26-77634	18-2014
23-43293T	18-1339	24-30893	18-2348	25-64068	18-7145	26-79831	18-2055
23-44165	18-4288	24-38191	18-4161	25-64966	18-7415	26-79831	18-2055
23-45736	18-2701	24-46312	18-4252	25-65936	18-7143	26-79831A1	18-2654
23-45736	18-2701-04	24-801879	18-1234	25-67202	18-7107	26-79884	18-2013
23-47392	18-2336	24-801879T	18-1234	25-67675	18-7164	26-79884	18-2026
23-48351	18-1329	24-811554	18-1234	25-69202	18-7419	26-80239M	18-2730-9
23-49168	18-1334	25-16524	18-7421	25-70937	18-7169	26-814622	18-1211
23-49171	18-1333	25-20081	18-7151	25-801334436	18-7168	26-814669A2	18-2635
23-52211	18-1300	25-20195	18-7134	25-803513007	18-7695	26-814754	18-8305
23-52221	18-1308	25-201951	18-7134	25-805726	18-7188	26-81607M	18-2731
23-52224	18-1309	25-20365	18-7135	25-806609	18-7165	26-816464	18-8347
23-52225	18-1341	25-20587	18-7168	25-8071341	18-1508	26-8164641	18-2054
23-52242	18-1329	25-20633	18-7116	25-807149	18-7163	26-8164641	18-8347
23-52261	18-1317	25-20679	18-7153	25-809086	18-0715	26-816575A1	18-2646-1
23-52264	18-1316	25-20826	18-7459	26-36143	18-2094	26-816575A2	18-2599
23-52270	18-1308	25-20863	18-7152	26-36556	18-0563	26-816575A3	18-2646-1
23-52273	18-1309	25-21720	18-7168	26-36557	18-0521	26-816575A4	18-8382
23-52274	18-1341	25-21836	18-7420	26-36557A1	18-3110	26-816575A5	18-2642
23-52928	18-3109	25-22174	18-7116	26-37259	18-2056	26-821309	18-3013
23-55419A1	18-2155	25-23145	18-7114	26-38970	18-3110	26-821310	18-3014
23-61290	18-2701	25-25439	18-7153	26-41131	18-0579	26-821928	18-0585
23-61290	18-2701-04	25-26543	18-0175	26-41132	18-0580	26-821947	18-1233
23-61291	18-2336	25-26722	18-7115	26-41365	18-0581	26-8219471	18-1233
23-67370	18-2349	25-26802	18-7180	26-41365A3	18-2697-1	26-82234M	18-0297
23-67484	18-1340	25-26834	18-7168	26-41953	18-2016	26-82257M	18-0267
23-69884	18-1334	25-26855	18-7155	26-42102	18-2728	26-82389A	18-2003
23-69887	18-1333	25-27018	18-7173	26-421021	18-2728	26-830749	18-2430
23-77631A2	18-2155	25-29439	18-7156	26-43034A1	18-2626	26-830749	18-24301-9
23-79373A1	18-2622	25-29845	18-7103	26-43034A2	18-2626	26-830749A01	18-2725
23-801793	18-1311	25-29976	18-7157	26-43034A3	18-2626	26-84813M	18-0554
23-801803	18-1320	25-30224	18-7173	26-43035	18-0583	26-85090A1	18-2629
23-805041A2	18-2622	25-30271	18-7426	26-43035A4	18-2626	26-85090A2	18-2624
23-806036A1	18-3760	25-30529	18-7171	26-43036	18-0522	26-85107	18-0537
23-807073	18-4288	25-30613	18-7158	26-43993	18-0523	26-854017M	18-0296
23-811858	18-1337	25-31305	18-7172	26-45577	18-2944	26-864319	18-3289
23-811858001	18-1337	25-31534	18-7159	26-455771	18-2944	26-88397A1	18-2644
23-815921A10	18-2353	25-31986	18-7160	26-45587	18-0525	26-88416	18-2094
23-815921A17	18-2353	25-32424	18-7162	26-46021	18-2009	26-888483	18-0564
23-815921A21	18-2353	25-32507	18-7127	26-48443	18-0526	26-892361	18-2009
23-815921A6	18-2353	25-32509	18-7165	26-49131	18-4022	26-89237	18-2056
23-815921A8	18-2353	25-32546	18-7161	26-49154	18-1233	26-89238	18-2014
23-815950	18-2341-1	25-33145	18-7162	26-49947	18-1211	26-89238A1	18-2652
23-8159501	18-2341-1	25-33465	18-7163	26-55682	18-2050	26-89238A2	18-2655
23-815950Q01	18-2341-1	25-33466	18-7164	26-55682A1	18-2653	26-896600	18-0560
23-816583	18-3222	25-33466	18-7164	26-56397	18-0527	26-897153	18-2010
23-818465	18-1300	25-33504	18-7170	26-56788	18-2008	26-897154	18-2006
23-818469	18-1317	25-35027	18-7117	26-56866	18-1230	26-8M0050563	18-4024
23-818469001	18-1317	25-35029	18-7121	26-56868	18-0528	26-90562	18-2011
23-818471	18-1316	25-35276	18-7135	26-58094	18-0518	26-90925	18-0864

O.E. #	SIERRA #	O.E. #	SIERRA #	O.E. #	SIERRA #	O.E. #	SIERRA #
MERCURY MARINE cont.		27-22023	18-2572	27-41246-1	18-3862	27-433373	18-2713
26-94038	18-2007	27-25848	18-2568	27-41382	18-2837	27-433374	18-2713
26-96503	18-2056	27-25849	18-2569	27-41417	18-2710	27-43337A1	18-2713
26-965031	18-2056	27-25851	18-2570	27-414171	18-2710	27-43777	18-2810
26-97530	18-0172	27-26891	18-2800	27-414172	18-2710	27-437771	18-2810
26-97664	18-4024	27-27936	18-0870	27-41418	18-2712	27-437772	18-2810
26-976641	18-4024	27-279361	18-0870	27-414181	18-2712	27-43779	18-2809
26-99325	18-0586	27-30603	18-2914	27-41449	18-0633	27-437791	18-2809
26-F694305	18-2014	27-30604	18-2915	27-414491	18-0633	27-437792	18-2809
26-F697118	18-2076	27-30803	18-0385	27-41475	18-2717	27-43779A87	18-4326
26-F697555	18-2077	27-31402	18-2571	27-414751	18-2717	27-443281	18-2943
27-11338	18-2513	27-31436	18-2837	27-414752	18-2717	27-443282	18-2943
27-11338A85	18-4319	27-31439	18-2836	27-414753	18-2717	27-443283	18-2943
27-11338A88	18-4319	27-31557	18-0385	27-414754	18-2717	27-443284	18-2943
27-11977	18-4408	27-32433	18-2914	27-414755	18-2717	27-45088	18-0373
27-11977A88	18-4388	27-32434	18-2915	27-414756	18-2717	27-45588	18-2622
27-11977A92	18-4388	27-32438	18-2801	27-414757	18-2717	27-45748	18-0385
27-11986	18-3879	27-32769	18-2823	27-414758	18-2717	27-45821	18-2614
27-11987	18-4408	27-32770	18-2824	27-41499	18-2716	27-45821	18-2820
27-11988	18-0311	27-32771	18-2825	27-414991	18-2716	27-46110	18-0942
27-11999	18-2845	27-32816	18-2896-1	27-414992	18-2714	27-46110A1	18-4353
27-13218	18-3877	27-32910	18-0356	27-414993	18-2714	27-46110A2	18-4353
27-13461A88	18-4340	27-33121	18-2830-1	27-414994	18-2714	27-46110A72	18-4353
27-13461A89	18-4340	27-33179	18-2917	27-414995	18-2714	27-46233	18-2836
27-13461A90	18-4340	27-331791	18-2552	27-41499A87	18-4334	27-46401	18-2830-1
27-13461A99	18-4340	27-331792	18-2552	27-41610	18-0467	27-46401A1	18-4396
27-13687	18-3877	27-33395	18-2949	27-41636A1	18-4381	27-46820	18-0418
27-13709	18-3878	27-33395A1	18-4394	27-41670-3	18-0336	27-46820A1	18-4397
27-13709T	18-3878	27-33395A2	18-4394	27-41670-5	18-0336	27-47453	18-3881
27-13865	18-1237	27-33918	18-0398	27-41811	18-0672	27-47453A1	18-4389
27-138651	18-1237	27-33956	18-0327	27-41812	18-2554	27-47510	18-2553
27-13937-6	18-0320	27-34041	18-0347	27-41812Q	18-2554	27-47510Q	18-2553
27-139581	18-2621	27-34042	18-0346	27-41813	18-0897	27-47590	18-2831
27-14241	18-0322	27-34043	18-2845	27-41899M	18-2785	27-475901	18-2831
27-14247	18-0405	27-34208	18-0328	27-42178	18-0633	27-47644	18-0342
27-142471	18-61513	27-34209	18-0329	27-42206	18-2559	27-47644	18-0342
27-14247T1	18-61513	27-34213	18-0889	27-42457A1	18-4377	27-476441	18-0342
27-14250	18-0976	27-34213A1	18-4375	27-42631	18-2919	27-48042	18-0885-1
27-14318 3	18-0323	27-34213A2	18-4375	27-426311	18-2919	27-48043	18-2832-1
27-14318-2	18-0323	27-34216	18-0887	27-42744	18-3879	27-48043	18-2832-1-9
27-146972	18-0644	27-34273	18-3880	27-43004009	18-2741	27-480431	18-2832-1
27-14697A87	18-4339	27-342731	18-3880	27-430041	18-2741	27-480431	18-2832-1-9
27-14765	18-25001	27-34274	18-3881	27-430042	18-2741	27-48164	18-2802
27-14901	18-0466	27-34278	18-3876	27-430043	18-2741	27-481641	18-2802
27-14901A1	18-0466	27-34486	18-0874	27-430045	18-2741	27-48330	18-3876
27-15172	18-0324	27-344861	18-0874	27-430047	18-2741	27-48399	18-0462
27-15172-3	18-0324	27-344863	18-0874	27-43004A86	18-4336	27-48713	18-0982-1
27-151724	18-0324	27-34502	18-0905	27-43004A90	18-4336	27-48818	18-2844
27-167371	18-0645	27-34614	18-2570	27-43004A99	18-4336	27-488181	18-2844
27-17145	18-0868	27-34891	18-0874	27-430051	18-2740	27-48818Q1	18-2844
27-17467	18-0664	27-34895	18-0976	27-430052	18-2740	27-49104	18-3877
27-18272	18-0881-1	27-34896	18-0891	27-430053	18-2740	27-49107	18-0348
27-18307-1	18-0643	27-34897	18-0891	27-430055	18-2740	27-49109	18-0980
27-183076	18-0643	27-34898	18-0876	27-430056	18-2740	27-49110	18-0903
27-187851	18-3861	27-35380	18-0893	27-430057	18-2740	27-49121	18-0464
27-187853	18-3861	27-35898A2	18-4395	27-43006-2	18-0339	27-49814	18-0467
27-18785T	18-3861	27-35898A3	18-4395	27-430066	18-0339	27-49936	18-0346
27-18786-1	18-3871	27-35898A4	18-4395	27-43007	18-0670	27-49953	18-0887
27-188891	18-0624	27-35982	18-2840	27-430073	18-0670	27-49955	18-0905
27-18937	18-3828	27-35996	18-2556	27-430075	18-0670	27-49955	18-2833
27-18937M	18-3828	27-35996	18-2617	27-43008	18-0341	27-52076	18-2833
27-19050	18-0642	27-35996A1	18-2556	27-430082	18-0341	27-52144	18-0466
27-190502	18-0642	27-35996A1	18-2617	27-430083	18-0341	27-52145	18-0347
27-190503	18-0642	27-37724	18-0879	27-430085	18-0341	27-52184	18-0874
27-190505	18-0642	27-37725	18-0103	27-430086	18-0341	27-52202	18-2845
27-190506	18-2735	27-37816	18-2507	27-430088	18-0341	27-52364	18-2946
27-19138	18-3804	27-37976	18-0988	27-43033	18-2564-1	27-524572	18-2848
27-19138M	18-3804	27-38501	18-0879	27-430331	18-2564	27-52546	18-2896-1
27-19202	18-2559	27-385011	18-0879	27-430331	18-2564-1	27-52550	18-0348
27-19204-2	18-2558	27-39164	18-3881	27-43034	18-2563	27-52571	18-0403
27-19206	18-0633	27-39316	18-0371	27-430341	18-2563	27-52579	18-0372
27-192061	18-0633	27-39401	18-0333	27-43047	18-2563	27-52584	18-2830-1
27-19315	18-3877	27-39402	18-0334	27-430471	18-2565	27-52892	18-0133
27-194541	18-2593	27-39623	18-2827	27-430472	18-2565	27-52893	18-2500
27-19551	18-2824	27-39625	18-2828	27-43186A1	18-4381	27-53045	18-2917
27-19552	18-2841	27-39915	18-2819-1	27-43337	18-2713	27-530451	18-2917
27-19553	18-2823	27-39923	18-1210-1	27-433371	18-2713	27-53354A1	18-2912-1
27-19701	18-0622	27-41245-1	18-3872	27-433372	18-2713	27-53650	18-4398
							18-2514

O.E. #	SIERRA #	O.E. #	SIERRA #	O.E. #	SIERRA #	O.E. #	SIERRA #
MERCURY MARINE cont.		27-64818T1	18-2614	27-73665	18-0133	27-8127551	18-2611
27-53863	18-2807	27-64857	18-0131	27-73666	18-0685	27-812755A01	18-2611
27-54014	18-2620	27-64940	18-2807	27-73814	18-0928-1	27-8127754	18-2610
27-54014	18-2847	27-65184	18-0465	27-738141	18-0928-1	27-8127755	18-2611
27-54014A1	18-2620	27-65577	18-0357	27-73866	18-0183-1	27-812867	18-2749
27-54014A1	18-2847	27-65744	18-0129	27-74264	18-3878	27-8128671	18-2749
27-54014Q1	18-2620	27-657441	18-0129	27-74264A1	18-4382	27-8128672	18-2729
27-54014Q1	18-2847	27-657442	18-0129	27-74511	18-2504	27-812867A91	18-4337
27-54014T1	18-2620	27-657443	18-0129	27-74830	18-2843	27-812867A96	18-4337
27-54014T1	18-2847	27-65788	18-2806	27-74830A1	18-4382	27-812867A97	18-4337
27-54529	18-0980	27-66101	18-2835	27-74830A3	18-4382	27-813859	18-0646
27-54529A1	18-4378	27-66102	18-0912	27-75450	18-0365	27-81417M	18-0292
27-54566	18-0183-1	27-661021	18-0912	27-75483	18-0611	27-814210	18-0463
27-54566A1	18-4399	27-66358	18-2837	27-75611	18-3876	27-81421M	18-0294
27-55279	18-2838	27-66847	18-0914	27-75611001	18-3876	27-814703	18-2815
27-552791	18-2838	27-67208	18-2513	27-75611A1	18-4392	27-814754A00	18-4338
27-55306A72	18-4355	27-67275	18-0359	27-75611A2	18-4392	27-815528	18-0680
27-55306A73	18-4355	27-672751	18-0359	27-75646	18-3883	27-815791A00	18-64217
27-55306A74	18-4355	27-67389	18-0864	27-75647	18-3883	27-815791A92	18-4359
27-55306A75	18-4355	27-67738	18-2501	27-75648	18-0410	27-815792A90	18-4359
27-55308	18-0940	27-67751	18-2509	27-75791	18-2800	27-815809A90	18-4359
27-55810	18-0894	27-68714	18-4380	27-757911	18-2800	27-815810A90	18-4359
27-558101	18-0894	27-68714A6	18-4380	27-75909	18-0369	27-816460	18-3879
27-56110	18-3883	27-68714A7	18-4380	27-75952	18-0151	27-817277	18-2566
27-56173	18-0352	27-68715	18-0956-1	27-76401	18-2504	27-8172771	18-2566
27-56304	18-0982-1	27-69238	18-2835	27-76589	18-0139	27-817533	18-0384
27-56859	18-0898	27-692381	18-2835	27-76589A77	18-4357	27-818188	18-1231
27-56870A1	18-0407	27-69524	18-0918	27-76589A78	18-4357	27-8181881	18-1231
27-56880	18-0147	27-695241	18-0918	27-76589A79	18-4357	27-818832	18-2849-1
27-56883	18-0889	27-695242	18-0918	27-76636	18-0151	27-81987	18-4698
27-56884	18-0357	27-69525	18-0131	27-76862	18-0932	27-81987M	18-4698
27-58025	18-7143	27-695251	18-0131	27-768621	18-0932	27-81987M	18-46981-9
27-58764	18-0353	27-695252	18-0131	27-76952	18-0101	27-822189	18-0345
27-60208	18-2834	27-69659	18-2800	27-77417	18-2841	27-822217	18-99155
27-60286	18-2512	27-70142	18-0360	27-78026	18-2507	27-822844-1	18-3864
27-60310	18-2504	27-70143	18-0994	27-78027	18-0940	27-823142	18-0378
27-60317	18-0904	27-701431	18-0994	27-78028A78	18-4355	27-823142 2	18-0378
27-60475	18-2573	27-70143B1	18-0994	27-78035	18-2836	27-824326	18-1238
27-60476	18-2574	27-70335	18-0922	27-78068	18-2503	27-824326002	18-0487
27-60476A72	18-4356	27-703351	18-0922	27-78069	18-0934-1	27-8243261	18-0487
27-60476A73	18-4356	27-70905	18-0158	27-78087	18-2837	27-824853	18-0835
27-60476A74	18-4356	27-72098	18-4380	27-78246	18-0135	27-8248531	18-0835
27-60476A75	18-4356	27-72142	18-2573	27-782461	18-0135	27-825032	18-3845
27-60477	18-2839	27-721421	18-2573	27-78409	18-0371	27-825482	18-3827
27-60479	18-2835	27-72479	18-4366	27-78410	18-0372	27-8254821	18-3827
27-60715	18-0354	27-72479A5	18-4366	27-78411	18-0373	27-827154	18-61319
27-60721	18-0905	27-72479T	18-4366	27-78623	18-0139	27-827284	18-2721
27-60945	18-0912	27-72486	18-0942	27-78690	18-0936	27-828292	18-0641
27-61224	18-3877	27-72486A32	18-4353	27-79373	18-2622	27-828553	18-0319
27-61782	18-0403	27-72486A76	18-4353	27-79650	18-0103	27-832933006	18-2739
27-62386	18-0182	27-72486A78	18-4353	27-796501	18-0103	27-8329331	18-2739
27-62860	18-0988	27-72486A79	18-4353	27-79986	18-3878	27-8329332	18-2739
27-628601	18-0988	27-72487	18-2507	27-801853	18-4387	27-8329333	18-2739
27-63309	18-2572	27-72496	18-0103	27-801855	18-4365	27-8329334	18-2739
27-64173	18-2835	27-72505	18-2500	27-803508	18-3844	27-8329335	18-2739
27-64203	18-0107	27-72506	18-2807	27-803508017	18-60917	27-834952001	18-60919
27-64203A73	18-4351	27-72507	18-2574	27-805215	18-0916	27-835427003	18-60918
27-64203A74	18-4351	27-72508	18-0944	27-8052151	18-0916	27-835427A04	18-64221
27-64203A75	18-4351	27-72509	18-2839	27-805396	18-0740-1	27-83899M	18-3828
27-64204	18-0944	27-72510	18-0107	27-805403A1	18-0404	27-83940M	18-0380
27-64692	18-0356	27-72622	18-3881	27-805722A1	18-0403	27-845628	18-1232
27-64763	18-3883	27-72627	18-0153	27-806452	18-0347	27-84733M	18-3804
27-64763A2	18-4391	27-72637	18-0868	27-807218	18-0928-1	27-850283	18-2737
27-64798	18-0407	27-72779	18-0916	27-807473A1	18-0488	27-850318	18-3675
27-64818	18-2614	27-72780	18-0386	27-807982	18-0994	27-8503181	18-3675
27-648181	18-2820	27-72915	18-0371	27-8079821	18-0994	27-850470	18-3887
27-64818A1	18-2614	27-72916	18-0372	27-807982B	18-0994	27-850836001	18-60916
27-64818A1	18-2820	27-72917	18-0373	27-81031M	18-0232	27-85087	18-2561
27-64818A2	18-2619-1	27-72918	18-2837	27-81084	18-2946	27-852957	18-7690
27-64818A2	18-2743	27-72919	18-2836	27-810846	18-1239	27-853702005	18-60920
27-64818A20	18-2614	27-73377	18-2804	27-810846T	18-1239	27-85487	18-2507
27-64818A20	18-2820	27-733771	18-2804	27-811546	18-3874	27-85488	18-0940
27-64818A3	18-2619-1	27-73397	18-0101	27-811547	18-3887	27-854881	18-0940
27-64818A3	18-2619-1	27-73440A76	18-4357	27-811566	18-1232	27-854882	18-0940
27-64818A4	18-2614	27-73645	18-0926	27-811572	18-0468	27-85489-2	18-0105
27-64818A4	18-2820	27-73645A32	18-4354	27-811588	18-25002	27-85490-2	18-2805
27-64818Q4	18-2614	27-73645A76	18-4354	27-812712	18-0403	27-85491	18-0942
27-64818Q4	18-2820	27-73645A87	18-4354	27-812755	18-2610	27-85491-2	18-0942

O.E. #	SIERRA #	O.E. #	SIERRA #	O.E. #	SIERRA #	O.E. #	SIERRA #
MERCURY MARINE cont.				27-89937	18-0385	27-995061	18-0667
27-854911	18-0942	27-8M0027781	18-0384	27-99757	18-2909	31-30894A1	18-1156
27-854913	18-0942	27-8M0049045	18-3877	27-99776	18-2508-1	31-30894A5	18-1182
27-85491A90	18-4325	27-8M0050224	18-0465	27-997761	18-2508-1	31-30895	18-1157
27-85492-2	18-0137	27-8M0077608	18-0905	27-99777	18-2833	31-30895T	18-1157
27-85493	18-2500	27-8M0090319	18-2914	27-997771	18-2833	31-30956	18-1158
27-85494	18-2807	27-8M2021920	18-0398	27-997772	18-2833	31-30956T	18-1158
27-85495	18-2574	27-90430	18-2803	27-997772	18-2833	31-32573A1	18-1142
27-854951	18-2574	27-904301	18-2803	27-99777A1	18-4367	31-32575A1	18-1179
27-854952	18-2574	27-90458	18-0411	27-99960	18-0389	31-32575T1	18-1179
27-85496	18-0944	27-90458A1	18-0411	28-43037	18-3293	31-32898	18-1115
27-854961	18-0944	27-90484	18-2502	28-81603M	18-3294	31-32898T	18-1115
27-85497	18-2839	27-90484A	18-2502	28-81912M	18-3305	31-33138A1	18-1193
27-854971	18-2839	27-90484A32	18-4317	28-83444M	18-3300	31-35246	18-1120
27-854972	18-2839	27-90484A86	18-4317	28-83701M	18-3305	31-35928A1	18-1159
27-85498	18-0107	27-90484A88	18-4317	28-8M0058389	18-2375	31-35928T1	18-1159
27-85498-1	18-0107	27-90556	18-2554	29-47270	18-4036	31-35988A12	18-1160
27-85608	18-2914	27-91831	18-0464	29-71422	18-4037	31-35988A2	18-1160
27-856081	18-2914	27-91892	18-0185	29-88258	18-1186	31-35990A1	18-1161
27-85609	18-2915	27-92166	18-3878	30-17927	18-1155	31-36387A1	18-1143
27-856091	18-2915	27-921661	18-3878	30-20066	18-1151	31-38356A1	18-1162
27-85610	18-2826	27-92331	18-2717	30-20464	18-1153	31-42647	18-1117
27-856101	18-2826	27-92332	18-2716	30-20839	18-1190	31-42647A1	18-1117
27-85653	18-0946	27-92648M	18-2787	30-20839T	18-1190	31-42677A1	18-1118
27-85653-1	18-0946	27-92720	18-0954	30-20861	18-1398	31-43012A1	18-1195
27-85653A32	18-4356	27-93214	18-0324	30-23679	18-1152	31-44348001	18-2748
27-85653A79	18-4356	27-93536	18-2501	30-35914	18-1155	31-47245A1	18-4038
27-85653A87	18-4356	27-935361	18-2501	30-36056	18-2101	31-48939A2	18-1144
27-856704	18-2826	27-94914	18-0386	30-36418	18-2101	31-48941A1	18-1163
27-856705	18-0113-1	27-94915	18-0916	30-41421	18-1345	31-54036A1	18-1126
27-856730	18-0946	27-94996	18-2619-1	30-43011	18-1346	31-54038A1	18-1127
27-85817A1	18-0153	27-94996	18-2743	30-43011T	18-1346	31-54042T	18-1180
27-858524	18-2915	27-94996A1	18-2743	30-49313	18-1153	31-54928	18-1356
27-858524	18-2915	27-94996A1	18-2743	30-54215	18-1153	31-55332A1	18-4038
27-858935	18-0649	27-94996A2	18-2619-1	30-562540A3	18-21005	31-58859A1	18-4038
27-85978	18-2710	27-94996A2	18-2743	30-60794A2	18-2100	31-61100A1	18-1165
27-85979	18-2712	27-94996A2	18-2743	30-60794A2	18-21001	31-61424A2	18-4038
27-860231	18-0672	27-94996A20	18-2619-1	30-60794A2	18-2100K	31-62596A1	18-4038
27-860232	18-2849-1	27-94996A20	18-2743	30-60794A4	18-2100	31-62799A1	18-1111
27-860233	18-0897	27-94996A3	18-2743	30-60794A4	18-21001	31-63075A1	18-4038
27-863724	18-0897	27-94996Q2	18-2619-1	30-60794A4	18-2100K	31-67526	18-1194
27-863725	18-0672	27-94996Q2	18-2743	30-62699	18-1190	31-67526A1	18-1194
27-8637251	18-0672	27-94996T2	18-2619-1	30-63326	18-1153	31-67526A2	18-1194
27-863726	18-2849-1	27-96171	18-2505	30-63326T	18-1153	31-73363	18-1122
27-863891	18-2736	27-961711	18-2505	30-63742	18-1154	31-73363T	18-1122
27-863893	18-2736	27-96278	18-2808	30-63742T	18-1154	31-74248	18-1196
27-863895	18-2736	27-96286	18-2713	30-67923	18-1345	31-74248T	18-1196
27-87105	18-2849-1	27-96429	18-1204-1	30-67923T	18-1345	31-78172A1	18-1166
27-871051	18-2849-1	27-96429	18-1204-1-9	30-72961	18-1398	31-803090T1	18-8208
27-87396	18-2502	27-96440	18-2508-1	30-803097T1	18-2601-1	31-803090T1	18-1170
27-87707	18-0948	27-96483	18-2810	30-803098T1	18-8205	31-814337A1	18-1194
27-879150139	18-3874	27-96485	18-2809	30-803099T1	18-8206-1	31-821146A1	18-1194
27-879150140	18-3879	27-96542-1	18-3863	30-803100T1	18-8212-1	31-828437A2	18-1173
27-879150141	18-3887	27-96761	18-2510	30-862540A04	18-21005	31-828439A2	18-1197
27-88046	18-0950	27-97529	18-3877	30-862540A04	18-21005K	31-86748A1	18-1129
27-880729	18-0791	27-97542	18-0113-1	30-862540A04	18-21006	31-88269T	18-1347
27-881715	18-0322	27-97863	18-0881-1	30-862540A3	18-21005K	31-8M0045428	18-1194
27-883964	18-0405	27-98185	18-2807	30-862540T1	18-21006	31-8M0045430	18-4039
27-883964T	18-0405	27-981851	18-2807	30-862540T1	18-21005K	31-8M0103473	18-1129
27-88449	18-2504	27-9818512	18-2807	30-862540T1	18-21006	31-8M0103474	18-1126
27-88449A32	18-4357	27-981853	18-2807	30-862540T1	18-21006	31-92366	18-1150
27-88449A80	18-4357	27-98769	18-0970	30-879194A01	18-21005	31-92366A1	18-1150
27-88451	18-0139	27-987691	18-0970	30-879194A01	18-21005K	31-F506818	18-1129
27-884511	18-0139	27-98823	18-0388	30-879194A02	18-21006	31-F523058	18-1158
27-88907	18-0952	27-988231	18-0388	30-879194A02	18-21001	31-F694057	18-1117
27-892157	18-2714	27-98990M	18-3828	30-879194A02	18-21001	31-F84901	18-1162
27-892158	18-2717	27-99173-2	18-2511	30-88957	18-1155	31-M8004528	18-1194
27-89221	18-0384	27-99176	18-2506-1	30-88957A1	18-1155	32-14358	18-2746
27-892211	18-0384	27-991762	18-2506-1	30-88957T	18-1155	32-14358T	18-2746
27-89221A32	18-4319	27-991763	18-2506-1	31-12576	18-1112	32-16011	18-70955
27-89221A84	18-4319	27-991764	18-2506-1	31-12578	18-1113	32-16012	18-70956
27-89221A85	18-4319	27-99177	18-2503	31-12578T	18-1113	32-16021	18-70925
27-89221A88	18-4319	27-991771	18-2503	31-14358001	18-2746	32-160211	18-70925
27-89656	18-2555	27-991772	18-2503	31-17514	18-1194	32-32461	18-3601
27-896561	18-2555	27-99326	18-2562	31-17514A1	18-1194	32-32461A1	18-3601
27-89656A1	18-4381	27-993261	18-2562	31-17514A2	18-1194	32-38377	18-2160
27-89657	18-0111	27-99506	18-0667	31-17514A2	18-4039	32-4172533	18-3602
				31-29982	18-1115	32-43437	18-3603
						32-44348	18-2748

O.E. #	SIERRA #	O.E. #	SIERRA #	O.E. #	SIERRA #	O.E. #	SIERRA #
MERCURY MARINE cont.		32-88005	18-2110	35-802893Q4	18-7983-1	35-8M0008397	18-7914
32-44348T	18-2748	32-88006	18-2111	35-80365M	18-7713	35-8M0020349	18-7981
32-45327	18-2110	32-883702K	18-7879-1	35-803897Q1	18-7784	35-8M0064104	18-7914
32-45959	18-2111	32-883702Q	18-7879-1	35-805369	18-7944	35-8M0079962	18-79911
32-45973	18-2105	32-887952	18-70952	35-805369	18-7945	35-8M0082290	18-79912
32-45974	18-2106	32-89653	18-70704	35-8053691	18-7845	35-8M0103095	18-7919
32-47373	18-2103	32-897181	18-70934	35-8053691	18-7944	35-93568	18-7717
32-47640	18-70931	32-897491	18-70943	35-8053691	18-7945	39-15320M	18-3976
32-48131	18-71218	32-8M0062309	18-3602	35-805369A4	18-7848-1	39-15320T	18-3976
32-48132	18-71218	32-8M0062614	18-75100	35-805809	18-7871	39-15322M	18-3978
32-48418	18-2126	32-8M0062665	18-75125	35-805809T	18-7871	39-17464	18-3937
32-52481	18-70930	32-8M0071007	18-70931	35-806771	18-7845	39-17465	18-3938
32-52951A1	18-2126	32-8M0090859	18-3603	35-806771	18-7944	39-18487A12	18-3924
32-5346170	18-75125	32-90949	18-2761	35-806771	18-7945	39-18653A1	18-3967
32-54236	18-3220	32-90949T	18-2761	35-807172	18-7844	39-18653A12	18-3966
32-55816	18-2107	32-95858	18-2435	35-807172	18-7845	39-18653A2	18-3968
32-59841	18-2108	32-95859	18-2436	35-807172	18-7944	39-18939M	18-3977
32-59841A1	18-2108	32-96246	18-70958	35-807172	18-7945	39-19721A1	18-4020
32-59842	18-2109	32-96246A1	18-70958	35-807172A4	18-7848-1	39-19721A2	18-4021
32-66073	18-2103	32-96246A4	18-70958	35-807172A4	18-7983-1	39-19721A6	18-4019
32-68676	18-2103	32-96879	18-70931	35-808275	18-7873	39-34479	18-3942
32-71613	18-70928	32-97153A1	18-2110	35-809097	18-7919	39-34988	18-3937
32-73004	18-2103	32-97154A1	18-2111	35-809099	18-7920	39-45155A12	18-3902
32-73005	18-2109	32-99902	18-2136	35-809100	18-7929	39-45204A12	18-3916
32-73123	18-2108	32-99902-1	18-2114	35-813405	18-7964-1	39-48344	18-3939
32-73794	18-70929	32-99903	18-2137	35-813405A1	18-7964-1	39-48345	18-3938
32-73795	18-70927	32-99903-1	18-2115	35-815419	18-7964-1	39-58096	18-3942
32-73796	18-70926	32-99904	18-2116	35-816296	18-7829	39-65153	18-3937
32-79431	18-2103	32-99904Q	18-2116	35-816296-1	18-7830	39-66217	18-3939
32-802885Q	18-7876-1	35-11004A1	18-7784	35-8162961	18-7830	39-67119	18-3942
32-8066351	18-70938	35-134301	18-7830	35-816296B1	18-7830	39-67123	18-3937
32-8066361	18-70939	35-14571A1	18-7967	35-816296B2	18-7830	39-67126	18-3938
32-8066362	18-70946	35-16248	18-7712	35-816296K03	18-7829	39-67127	18-3940
32-806825	18-71337	35-16494	18-7829	35-816296Q	18-7829	39-67132	18-3942
32-806856	18-70935	35-164941	18-7830	35-816296Q2	18-7830	39-74381A1	18-3928
32-807407	18-70949	35-17808A1	18-7967	35-816296T	18-7829	39-75422	18-3928
32-807458T	18-2770	35-184585	18-7968	35-816296T1	18-7830	39-75609	18-3944
32-8078961	18-70951	35-18458A2	18-7967	35-816396Q1	18-7830	39-78811A12	18-3916
32-8078962	18-70951	35-18458Q3	18-7967	35-8226267	18-7906-1	39-78816A12	18-3902
32-808033	18-70948	35-18458Q4	18-7968	35-822626K04	18-7914	39-78918A4	18-3922
32-8080441	18-70953	35-49088	18-7860	35-822626Q03	18-7913	39-81096M	18-3986
32-814384	18-3221	35-49088A2	18-7860	35-822626Q04	18-7914	39-813011A12	18-3927
32-858104K08	18-8024EP-2	35-49088Q2	18-7860	35-822626Q15	18-7913	39-815267A4	18-3925
32-858104Q08	18-8024EP-2	35-52456	18-7944	35-822626Q2	18-7906-1	39-817096A16	18-3919
32-858105K08	18-8025EP-2	35-52456	18-7945	35-822626Q2	18-7914	39-817096A26	18-3920
32-858105Q08	18-8025EP-2	35-52456A1	18-7848-1	35-822626T2	18-7914	39-817096A6	18-3918
32-858109K12	18-8016EP-2	35-52456A1	18-7983-1	35-822626T7	18-7906-1	39-822321A12	18-3982
32-858109K12	18-8016S-1	35-53336	18-7859	35-853333	18-7997	39-822321A2	18-3984
32-858109Q12	18-8016EP-2	35-53336Q	18-7859	35-853333T	18-7997	39-824905A12	18-3982
32-858114K08	18-8012EP-2	35-55501	18-7845	35-864572	18-7721	39-826293A12	18-4051
32-858114Q08	18-8012EP-2	35-55501	18-7845	35-866171A01	18-7977	39-826297A12	18-4052
32-860089	18-70954	35-55501	18-7944	35-866340K01	18-7824-2	39-827179A12	18-4050
32-8600891	18-70954	35-55501	18-7945	35-866340Q	18-7824-2	39-83196M	18-3992
32-860144	18-70940	35-55501A1	18-7848-1	35-866340Q02	18-7824-2	39-85636A4	18-3923
32-860205	18-70951	35-57250	18-7845	35-866340Q02	18-7824-2	39-88392	18-3917
32-860220	18-3221	35-57250	18-7944	35-866340Q03	18-7876-1	39-88392A12	18-3917
32-86036	18-2103	35-57250	18-7945	35-866340Q03	18-7824-2	39-93481A12	18-3921
32-86036A1	18-2103	35-57250A1	18-7848-1	35-866340Q03	18-7876-1	39-96170A12	18-3979
32-86036Q	18-2103	35-60494	18-7983-1	35-866594K01	18-7596	39-96170A4	18-3981
32-861127	18-2435	35-60494	18-7944	35-877565T	18-7714	39-97125	18-3939
32-861128	18-2436	35-60494	18-7945	35-877565T1	18-7714	40-52035	18-4294
32-861590A05	18-71337	35-60494	18-7945	35-877761K01	18-7758	43-17064A3	18-2407
32-861590A1	18-71337	35-604941	18-7845	35-877761Q01	18-7758	43-18410A2	18-2201
32-861590A2	18-71337	35-604941	18-7944	35-877767K01	18-7921	43-18411A2	18-2201
32-861635	18-44092	35-604941	18-7945	35-877768K01	18-7914	43-42933A2	18-2407
32-862124	18-70947	35-60494A1	18-7848-1	35-877769K01	18-7918	43-42933A3	18-2407
32-862139	18-70945	35-60494A1	18-7983-1	35-87946A3	18-7802	43-45814A5	18-2203
32-864588	18-2137	35-60494A4	18-7845	35-87946Q3	18-7802	43-55765A2	18-2203
32-864589	18-2136	35-60494A4	18-7848-1	35-87946Q4	18-7802	43-55765A3	18-2203
32-864959	18-2115	35-60494A4	18-7983-1	35-87946Q4	18-7802	43-55766A2	18-2205
32-864960	18-2114	35-802884Q	18-7879-1	35-879885T	18-7718	43-55766A3	18-2205
32-865672070	18-75125	35-802885Q	18-7824-2	35-880084T01	18-7523	43-55766A3	18-2205
32-87116	18-70925	35-802886Q	18-7875	35-883701K01	18-7918	43-55778A3	18-2205
32-87117	18-70932	35-802893A4	18-7983-1	35-884380T	18-7981	43-59832A2	18-2201
32-871171	18-70932	35-802893Q	18-7844	35-886638	18-7948	43-59832A4	18-2201
32-87234	18-2112	35-802893Q	18-7944	35-888289T2	18-7936	43-61027	18-2200
32-87235	18-2113	35-802893Q	18-7945	35-892665	18-7715	43-75325A2	18-2204
		35-802893Q4	18-7848-1	35-896247	18-7999	43-75325A3	18-2204
				35-896546T	18-7921	43-803069T1	18-2369

O.E. #	SIERRA #	O.E. #	SIERRA #	O.E. #	SIERRA #	O.E. #	SIERRA #
MERCURY MARINE cont.				46-48746A3	18-3118	47-59362A4	18-3216
43-803071T1	18-2368	46-48747A3	18-3517	47-59362Q08	18-3318	50-66015T1	18-5642
43-803079T1	18-2404	46-48748A1	18-3421	47-59362T	18-3087	50-67341	18-5602
43-803091T1	18-2405	46-57234A1	18-3417	47-65957	18-3039	50-69865A1	18-5903
43-803101T1	18-2259	46-57234A3	18-3517	47-65958	18-3052	50-72467	18-5636
43-803102T1	18-2358	46-58618A4	18-3517	47-65960	18-3017	50-72550A2	18-5907
43-803103T1	18-6351K	46-59112A2	18-3600	47-68988	18-3054	50-73521	18-5605
43-803104T1	18-6350K	46-60366A1	18-3507	47-72774A89	18-3155	50-73521T	18-5605
43-803105T1	18-6353K	46-60367A4	18-3517	47-80395M	18-3072	50-76965A3	18-5908
43-803106T1	18-6352K	46-63450A2	18-3600	47-81242M	18-3063	50-76965A4	18-5911
43-803112T1	18-2257	46-64141A1	18-3116	47-81423M	18-3069	50-76967A1	18-5908
43-803114T1	18-2258	46-64141A11	18-3517	47-81604M	18-3067	50-77141	18-5608
43-803116T1	18-2256	46-65498A1	18-3422	47-82824M	18-3069	50-77141	18-5608
43-803118T1	18-2363	46-68390A1	18-3422	47-84027M	18-3074	50-77328A1	18-6275
43-803119T1	18-2364	46-69222A3	18-3517	47-84027T	18-3074	50-77328A3	18-5911
43-803120T1	18-2365	46-70941A3	18-3446	47-84797M	18-3067	50-77328A3	18-6275
43-803615T1	18-1564	46-72774A11	18-3600	47-85089-3	18-3057	50-79472	18-5608
43-803615T2	18-1551	46-72774A32	18-3600	47-85089T7	18-3215	50-79472	18-5608
43-803615T2	18-1564	46-73640A1	18-3423	47-85460	18-3017	50-79472 1	18-5608
43-821823A1	18-6350	46-73640A2	18-3323	47-862232A2	18-3016-1	50-79472 1	18-5608
43-823072A2	18-2407	46-73802A2	18-3416	47-89980	18-3054	50-79604A3	18-5907
43-828072A2	18-2206-1	46-73802A3	18-3517	47-89981	18-3039	50-804312T1	18-6425
43-828072A3	18-2360	46-73804A1	18-3414	47-89982	18-3052	50-805833	18-6870
43-828073A1	18-2206-1	46-73804A3	18-3517	47-89982T1	18-3252	50-805833T	18-6870
43-828073A1	18-2408	46-73823A7	18-3600	47-89983	18-3007	50-806963A4	18-5919
43-828175A1	18-1566	46-73842A2	18-3422	47-89983Q1	18-3207	50-806964A2	18-6275
43-850036	18-1560	46-77177A1	18-3424	47-89983T	18-3007	50-806964A3	18-6275
43-850036T	18-1560	46-77177A3	18-3324	47-89983T2	18-3207	50-806964A4	18-6275
43-853640A2	18-6350	46-77516A1	18-3422	47-89984	18-3017	50-806965A2	18-5919
43-853641A2	18-6351	46-77516A3	18-3322	47-899842	18-3017	50-806965A4	18-5919
43-853642A2	18-6352	46-77822A1	18-3118	47-899844	18-3017	50-807904A1	18-6275
43-853643A2	18-6353	46-78400A1	18-3416	47-89984T3	18-3017	50-808011A05	18-5908
43-878072A3	18-2406	46-78400A2	18-3316	47-89984T4	18-3017	50-808011A1	18-5908
43-878087A2	18-2206-1	46-78400A2	18-3517	47-8M0100526	18-3265	50-808011A3	18-5908
43-878087A2	18-2360	46-8037502	18-43212	47-95289	18-45312	50-808011A4	18-5603-1
43-878087A2	18-2406	46-803750A02	18-43212	47-952892	18-45312	50-808011A4	18-5908
43-878087A4	18-2407	46-803750A03	18-48317	47-95611M	18-3063	50-812428A3	18-5913-1
43-881260A3	18-1550	46-807151A14	18-3150	47-96305M	18-3073	50-812428A3	18-6275
43-92320	18-2409	46-807151A7	18-3150	47-96619M	18-3074	50-812604A2	18-5913-1
43-92320T	18-2409	46-812966A7	18-3445	47-97108M	18-3069	50-812604A2	18-6275
43-96084A4	18-2200	46-812996A3	18-3445	50-12066A1	18-4915	50-818445-2	18-5620
43-96084A5	18-2410	46-812996A9	18-3445	50-12066A9	18-4915	50-818445-3	18-5620
43-96084A7	18-2410	46-84277M	18-3148	50-12066Q9	18-4915	50-8184455	18-5620
44-17915	18-2260	46-84277T	18-3148	50-12121A2	18-6275	50-819271	18-6864
44-55857	18-2166	46-862914A13	18-3160-1	50-12177A2	18-5910	50-820193A1	18-6864
44-66060	18-2166	46-879194401	18-3506	50-12177A2	18-6275	50-822330A2	18-5913-1
44-660602	18-2166	46-96146A2	18-3416	50-12872	18-5903	50-822330A2	18-6275
44-660603	18-2166	46-96146A5	18-3414	50-17251A2	18-5908	50-822462	18-5621
44-824110	18-2166	46-96146A6	18-3416	50-17251A3	18-5908	50-822462T1	18-5621
44-850308	18-2254	46-96148	18-3116	50-17251A3	18-5911	50-825991A2	18-6940
44-94148	18-2239	46-96148A1	18-3116	50-22791A1	18-4915	50-830308T	18-6437
44-98418	18-2260	46-96148A5	18-3517	50-28985A2	18-4915	50-831001671	18-6954
45-42634	18-2180	46-96148A8	18-3316	50-38890A1	18-5601	50-831001672	18-6954
45-43031A1	18-1736	46-96148A8	18-3517	50-41583	18-6828	50-831002050	18-6954
45-440001	18-1737	46-96148T1	18-3116	50-44369	18-5606	50-831002051	18-6954
45-55796	18-2179	47-11590M	18-3066	50-44369A1	18-5602	50-831002052	18-6954
45-557961	18-2324	47-16154	18-3098	50-44369A1	18-5606	50-8329972	18-6282
45-816919	18-2261	47-161543	18-3098	50-44369A1	18-5642	50-8331535	18-6283
45-853647	18-2331	47-19453	18-8900	50-44414	18-5608	50-834749	18-6436
45-853648	18-2331	47-20813	18-3008	50-44414	18-5608	50-852570	18-6829
46-32437A1	18-3517	47-22748	18-3012	50-44415	18-5608	50-852570T	18-6829
46-32437A3	18-3316	47-25287	18-3008	50-44415	18-5608	50-853329T	18-6440
46-42040A1	18-3149-2	47-30221	18-3017	50-45093	18-4915	50-854636T	18-6438
46-42040A3	18-3149-2	47-39074	18-3039	50-47455	18-5908	50-857065	18-6829
46-42040A5	18-3149-2	47-420381	18-3062	50-55601	18-5601	50-859168	18-6829
46-42579A3	18-3419	47-420382	18-3062	50-55601A2	18-5601	50-859168T	18-6829
46-42579A4	18-3319	47-42038Q02	18-3062	50-56886	18-5903	50-859169T	18-6437
46-42579A4	18-3517	47-430261	18-3056	50-57465A1	18-5636	50-859170T	18-6438
46-43024A3	18-3572	47-430262	18-3056	50-57867	18-5636	50-859171T	18-6436
46-44292A3	18-3420	47-430264	18-3056	50-58788A3	18-5602	50-859377T	18-6435
46-44292A4	18-3517	47-43026Q06	18-3265	50-58788A3	18-5636	50-863007A1	18-6275
46-44292Q03	18-3420	47-43026T11	18-3214	50-60315	18-5606	50-864340A2	18-5913-1
46-44292T1	18-3420	47-43026T11	18-3265	50-64975	18-5636	50-864340A2	18-6275
46-48743A1	18-3116	47-43026T2	18-3056	50-65784A1	18-5908	50-86976	18-6825
46-48744A3	18-3448	47-43026T6	18-3214	50-66015	18-5642	50-884044T	18-6435
46-48745A1	18-3422	47-43026T8	18-3214	50-660151	18-5610	50-884045T	18-6438
46-48746A1	18-3118	47-56780	18-3052	50-660153	18-5610	50-888151T	18-6437
		47-59362	18-3087	50-66015T	18-5610	50-888160T	18-6438

O.E. #	SIERRA #	O.E. #	SIERRA #	O.E. #	SIERRA #	O.E. #	SIERRA #
MERCURY MARINE <i>cont.</i>		57-65607Q	18-15370	57-96834Q	18-15500	87-17009A2	MP41070-2
50-888161T	18-6435	57-65607T	18-15370	57-96834T	18-15500	87-17009A5	MP51090
50-892339T	18-6440	57-69143Q	18-15400	81-64851	18-5346	87-17009A5	MP51092
50-893890T	18-5621	57-69143T	18-15400	84-43376A12	18-8802-1	87-18211	18-5729
50-893891T	18-5602	57-74271	18-15345	84-43376A7	18-8800-1	87-19761	18-5737
50-893891T	18-5642	57-74271Q	18-15345	84-43376A8	18-8809-1	87-71831	18-5317
50-893892T	18-5610	57-74271T	18-15345	84-43376A9	18-8803-2	87-861780A2	18-5116-1
50-893894	18-6943	57-76269	18-15405	84-813706A26	18-5225	87-861780Q4	18-5116-1
50-897755T	18-6840	57-76269Q	18-15405	84-813706A56	18-28081	87-88107	MP41000
50-898265005	18-5605	57-77274	18-15345	84-813715A1	18-5227-1	87-88107A5	MP52000
50-8M0033984	18-5611	57-77274A1	18-15325	84-813715A1	18-5228-1	87-892150A02	18-5116-1
50-90983A1	18-5611	57-78200	18-15470	84-813715A8	18-28082	88-79023A91	18-8220
50-90983T1	18-5611	57-78200A1	18-15470	84-813720A10	18-8803-2	88-93582	18-15501
50-97499A2	18-5907	57-78200Q1	18-15470	84-813720A11	18-8810-1	89-15857	18-5815
50-97499R4	18-5907	57-8077554	18-15112	84-813720A12	18-8802-1	89-18080	18-5837
50-99417A2	18-5911	57-8077555	18-15113	84-813720A13	18-8811-1	89-61053	18-5815
50-99418A2	18-5910	57-8077550Q4	18-15112	84-813720A2	18-8804-1	89-65258	18-5815
50-99418A2	18-6275	57-816295Q	18-15490	84-813720A3	18-8804-1	89-68258A4	18-5815
50-99419A3	18-5908	57-816295T	18-15490	84-813720A3	18-8821-1	89-76416A1	18-5801
50-99419A3	18-5911	57-816544	18-15410	84-813720A4	18-8804-1	89-76545	18-5815
52-12777	18-2236	57-817113	18-15125	84-813720A4	18-8821-1	89-76545T	18-5815
52-34239	18-2236	57-828507Q4	18-18100	84-813720A5	18-8800-1	89-817109A2	18-5834
52-66063	18-2202	57-861049	18-15114	84-813720A6	18-8808-2	89-818864	18-5818
52-814756	18-2236	57-8610491	18-15102	84-813720A7	18-8801-1	89-818864T	18-5818
52-822539	18-2236	57-861049Q	18-15114	84-813720A8	18-8809-1	89-818997A1	18-5819
52-822539T	18-2236	57-861050	18-15103	84-813720A9	18-8803-2	89-818997A2	18-5819
52-824112	18-2202	57-861757	18-15115	84-816608A14	18-8833-1	89-818997T1	18-5819
52-850048T	18-1562	57-861757Q	18-15115	84-816608A68	18-8832-1	89-818999A2	18-5820
52-853594	18-2202	57-861758	18-15116	84-816608A71	18-8836-1	89-825096T	18-5821
52-853594T	18-2202	57-861758Q	18-15116	84-816608A81	18-8822-1	89-825842A1	18-5820
52-859340T	18-1565	57-861759	18-15117	84-816608A83	18-8834-1	89-850188T1	18-5820
53-29641	18-4295	57-862086	18-15101	84-816608K68	18-8832-1	89-853654A1	18-5815
53-805272	18-4289	57-8620861	18-15101	84-816608Q14	18-8833-1	89-91975	18-5816
53-815949	18-2345	57-862086A1	18-15101	84-816608Q61	18-8804-1	89-96054	18-5816
53-850048	18-1562	57-862087A1	18-15100	84-816608Q68	18-8832-1	89-96054T	18-5816
54-31765	18-710-72-2	57-862088	18-15105	84-816608Q71	18-8836-1	89-96158	18-5817
54-32533	18-710-48-2	57-862088A1	18-15105	84-816608Q78	18-8824-1	89-96158T	18-5817
54-38863	18-7321	57-862089	18-15104	84-816608Q80	18-8830-1	89-99253	18-5838
54-41582-7	18-8020	57-862089A1	18-15104	84-816608Q81	18-8822-1	91-12037	18-9806E
54-815504348	18-710-48-2	57-8623523	18-15119	84-816608Q82	18-8835-1	91-12427	18-9807
54-866507	18-7321	57-862807	18-15100	84-816608Q83	18-8834-1	91-12427T	18-9807
54-8M0090424	18-7321	57-8638761	18-15119	84-816761A12	18-8802-1	91-14311A04	18-9874
56-18541A75	18-2464	57-86387610	18-15122	84-816761A17	18-8821-1	91-14311A1	18-9874
56-864641A24	18-2464	57-8638763	18-15100	84-816761A4	18-8804-1	91-14311A2	18-9874
57-13457	18-15290	57-8638764	18-15101	84-816761A4	18-8821-1	91-15755	18-9808
57-13457Q	18-15290	57-8638765	18-15121	84-816761A7	18-8800-1	91-15755T	18-9808
57-13457T	18-15290	57-8638766	18-15102	84-816761A8	18-8809-1	91-17256	18-9803
57-13458	18-15550	57-8638767	18-15103	84-816761A9	18-8803-2	91-17257	18-9809
57-13458Q	18-15550	57-8638768	18-15104	84-816761K14	18-8833-1	91-17262A1	18-9810
57-13458T	18-15550	57-8638769	18-15105	84-816761Q10	18-8803-2	91-17275A1	18-9812
57-32850	18-15400	57-864639	18-15123	84-816761Q12	18-8802-1	91-23033	18-9817
57-32850	18-15410	57-865423005	18-15121	84-816761Q13	18-8811-1	91-23033T	18-9817
57-33170	18-15520	57-865615001	18-15119	84-816761Q16	18-8810-1	91-24150	18-9817
57-33170Q	18-15520	57-865615003	18-15100	84-816761Q17	18-8821-1	91-29310	18-9814
57-36356	18-15415	57-865615004	18-15101	84-816761Q3	18-8804-1	91-30366T1	18-9816
57-37619T	18-15520	57-865615005	18-15121	84-816761Q3	18-8821-1	91-30500	18-9785
57-45856	18-15440	57-865615006	18-15102	84-816761Q4	18-8804-1	91-31107	18-9817
57-48120	18-15460	57-865615007	18-15103	84-816761Q4	18-8821-1	91-31107T	18-9817
57-48120A1	18-15460	57-865615008	18-15104	84-816761Q5	18-8800-1	91-31109	18-9808
57-48120Q1	18-15460	57-865615009	18-15105	84-816761Q6	18-8808-2	91-31229	18-9819
57-48122	18-15480	57-865615010	18-15122	84-816761Q7	18-8801-1	91-31229A7	18-9820-1
57-48122Q	18-15480	57-865615Q01	18-15119	84-816761Q8	18-8809-1	91-32325	18-9821
57-49043	18-15410	57-865615Q03	18-15100	84-816761Q9	18-8803-2	91-32325T	18-9821
57-49043A1	18-15410	57-865615Q04	18-15101	84-821945A56	18-28080	91-32336	18-9822
57-49211	18-15430	57-865615Q05	18-15121	84-847701A7	18-8837-1	91-33489	18-9823
57-49211	18-15435	57-865615Q06	18-15102	84-847701Q7	18-8837-1	91-33491	18-9824
57-49213A1	18-15440	57-865615Q07	18-15103	84-863656A1	18-8828-1	91-33492	18-9825
57-49756	18-15300	57-865615Q08	18-15104	84-863656A2	18-8829-1	91-33492T	18-9825
57-52692	18-15390	57-865615Q09	18-15105	84-881262A2	18-6500	91-33493	18-9826
57-53215	18-15290	57-880566014	18-15128	84-881698	18-8838-1	91-33493T	18-9826
57-53215T	18-15290	57-881754	18-15124	84-881908T	18-28083	91-34379T	18-9827
57-64032	18-15410	57-892318	18-18000	84-881908T	18-28084	91-36235	18-9803
57-64032A1	18-15410	57-895120	18-15149	84-881908T	18-28085	91-36379	18-9828
57-64032Q1	18-15410	57-895120002	18-15150	84-881908T	18-28086	91-36569	18-9829
57-64416	18-15430	57-91035	18-15495	84-90816A26	18-5225	91-36569T	18-9829
57-64416	18-15435	57-91035A1	18-15495	84-93212A1	18-5225	91-36571	18-9830
57-65607	18-15370	57-91035Q1	18-15495	84-93475A26	18-5225	91-36571T	18-9830
		57-96834	18-15550	84-99215A26	18-5225	91-36577	18-9831

O.E. #	SIERRA #	O.E. #	SIERRA #	O.E. #	SIERRA #	O.E. #	SIERRA #
MERCURY MARINE cont.		91-99750A1	18-9801	92-8M0078627	18-9400CAT-2P	391-7057T	18-5404-1
91-36577T	18-9831	91-99750A1	18-9801	92-8M0078629	18-9440CAT-2	391-898253001	18-5338
91-37263	18-9808	92-34227	1525607	92-8M0078629	18-9440CAT-2P	391-898253004	18-5314
91-37292	18-9832	92-342271	1525607	97-31640B4	18-6011	391-898253029	18-5404-1
91-37311	18-9833	92-34227Q02	1525607	97-31640Q4	18-6011	392-2529	18-6256
91-37312	18-9834	92-41669-1	37534	97-34672C	18-6013	392-2940	18-6254
91-37323	18-9835	92-59327-1	37509	97-762145	18-6016	392-6318	18-5369
91-37324	18-9815	92-78383A12	18-9013	97-76214Q5	18-6016	392-6318T	18-5369
91-37350	18-9836	92-78383A12	18-9024	97-806188A1	18-6117A	392-6324	18-5347
91-37384	18-4442	92-78383A12	18-9065	97-806188A1	18-6117M	392-6325	18-5303
91-38277A1	18-4444	92-78383A12	18-9080	97-806188A1	18-6117Z	392-6326	18-5407
91-38628T	18-9837	92-802833Q1	18-9420-2P	97-806188Q01	18-6117A	392-6326T	18-5407
91-38756	18-9838	92-802833Q1	18-9420-2	97-806188Q01	18-6117M	392-6329	18-5399
91-38918T	18-9839	92-802835Q1	18-9420-3P	97-806188Q01	18-6117Z	392-7803A4	18-5438
91-38919	18-9840	92-802835Q1	18-9420-30	97-806189	18-6067	392-805570A2	18-5438
91-42840T	18-9841	92-802835Q1	18-9420-30P	97-806189	18-6067A	392-806529A1	18-5433
91-43506T	18-9842	92-802835Q1	18-9420-3	97-806189Q1	18-6067	392-8261A1	18-6768
91-43559	18-9843	92-802836A1	18-9420-7P	97-806189Q1	18-6067A	392-8261A1	18-6799
91-43579	18-9844	92-802836A1	18-9420-7	97-806190	18-6089	392-8263	18-6768
91-43591T	18-9845	92-802837Q1	18-9400-2	97-806190B4	18-6089	392-8263	18-6799
91-44110	18-9846	92-802841A1	18-9400-7	97-806190Q1	18-6089	392-881732	18-7648
91-44307A1	18-9874	92-802844Q02	18-9600-0	97-821629Q1	18-6080	392-898253002	18-5347
91-45497A1	18-9847	92-802859A1	18-9240-0	97-821629Q1	18-6099	392-898253005	18-5303
91-47448A1	18-9896	92-802863A1	18-9240-1	97-821630Q1	18-6094	392-8989	18-6255
91-48347	18-4442	92-802881A1	1525607	97-826134Q	18-6068	392-9086	18-5353
91-52393	18-9848	92-802882A1	37534	97-888755Q03	18-6158M	392-9086T	18-5353
91-52394	18-9849	92-809819	37478	97-888756Q03	18-6158A	392-9089	18-5403
91-53459	18-9850	92-809820	37479	97-888758Q03	18-6159A	392-9089Q	18-5403
91-55916	18-9851	92-809824	37509	97-888759Q03	18-6159M	392-9089T	18-5403
91-55918	18-9852	92-817529A12	18-9013	97-888760Q03	18-6160M	392-9766	18-5352
91-56048001	18-9853	92-817529A12	18-9024	97-888761Q03	18-6160A	392-9766Q1	18-5352
91-56048T	18-9853	92-817529A12	18-9065	332-4911A5	18-5787	392-9766T	18-5352
91-56775T	18-9854	92-817529A12	18-9080	332-4911A8	18-5787	392-9767	18-5403
91-57797A1	18-4442	92-823506 1	37534	332-5524A1	18-5775	393-3230	18-5389
91-57797A2	18-4442	92-857389A1	18-9400-4	332-5772A1	18-5881	393-4988	18-5389
91-57797A3	18-4442	92-858007Q01	18-9600-5	332-5772A2	18-5881	393-4988T	18-5389
91-60523	18-9855	92-858007Q01	18-9600-5P	332-5772A3	18-5881	393-4988T2	18-5389
91-60526T	18-9856	92-858008Q01	18-9650-5	332-5772A5	18-5881	393-9459	18-5385
91-61067A3	18-9857	92-858008Q01	18-9650-5P	332-7778A1	18-5775	393-9459Q1	18-5385
91-61069T	18-9858	92-858037K01	18-9530-3	332-7778A12	18-5775	393-9459T	18-5385
91-61077	18-9868	92-858039K01	18-9530-7	332-7778A3	18-5775	394-1100A2	18-5148
91-63616	18-9859	92-858042K01	18-9553-3	332-7778A6	18-5775	394-1100A3	18-5148
91-63638T	18-9860	92-858042Q01	18-9553-3	332-7778A7	18-5775	394-1130	18-5169
91-74057Q6	18-9782	92-858057K01	18-9440-7	332-7778A9	18-5775	394-1130A1	18-5169
91-74057Q6	18-9783	92-858058Q01	18-9600-2	336-3948A2	18-5139	394-352A1	18-5148
91-75132	18-9896	92-858058Q01	18-9600-2P	336-3948A3	18-5139	397-359	18-5169
91-78310	18-9861	92-858061Q01	18-9600-6	336-3996A7	18-5855	397-741	18-5169
91-813653	18-9873	92-858062Q01	18-9600-7	336-4318A2	18-5139	398-174	18-5153
91-817570T	18-9869	92-858064Q01	18-9600-7P	336-4318A3	18-5139	398-2202	18-5140
91-818162	18-9870	92-858064Q01	18-9650-2	336-4318A4	18-5139	398-5255	18-5856
91-818169T	18-9871	92-858064Q01	18-9650-2P	339-6222A8	18-5788	398-5454A17	18-5854
91-821571A1	18-9872	92-858067Q01	18-9650-6	339-7370A13	18-5186	398-5454A21	18-5874
91-821887A1	18-4459	92-858067Q01	18-9650-6P	339-7452A1	18-5776	398-5454A22	18-5859
91-850730Q01	18-9781	92-858068Q01	18-9650-7	339-7452A11	18-5778	398-5454A25	18-5874
91-859046Q4	18-4459	92-858068Q01	18-9650-7P	339-7452A14	18-5778	398-5454A32	18-5871
91-859046T4	18-4459	92-858084K01	18-9552-3	339-7452A15	18-5777	398-5454A35	18-5860
91-87119	18-9862	92-883722K01	18-9440-8	339-7452A19	18-5777	398-5454A63	18-5874
91-878232	18-9896	92-883723K01	18-9440-3	339-7452A2	18-5776	398-5454A7	18-5857
91-879172T28	18-79816	92-883724K01	18-9440-2	339-7452A21	18-5778	398-5704A7	18-5865
91-883704Q03	18-9794	92-883724K01	18-9440-2P	339-7452A3	18-5776	398-5919A2	18-5874
91-895343A02	18-9897	92-883725K01	18-9440-4	339-7452A7	18-5777	398-5919A3	18-5859
91-895343T01	18-9897	92-883725K01	18-9440-4P	339-7452A8	18-5778	398-5919A4	18-5866
91-895343T02	18-9897	92-8M0062765	18-8606	339-7452A9	18-5777	398-5919A6	18-5874
91-896661	18-79814	92-8M0071837	18-9200-2	339-832757A4	18-5186	398-5919A7	18-5859
91-89865	18-9863	92-8M0071837	18-9200-4	339-850227	18-5187	398-5919A8	18-5874
91-89897	18-9866	92-8M0071838	18-9200-0	339-856991A1	18-5187	398-693	18-5206
91-8M0067546	18-4442	92-8M0071841	18-9200-1	339-859738T1	18-23205	398-713	18-5207
91-8M0072133	18-9781	92-8M0078618	18-9420CAT-7	339-880615T01	18-5154	398-818535A15	18-5874
91-8M0101435	18-9650-2QP	92-8M0078618	18-9420CAT-7P	391-5075	18-5376	398-832075-A21	18-5870
91-90244A1	18-9875	92-8M0078621	18-9400CAT-7	391-5075Q1	18-5376	398-832075A14	18-5874
91-90455	18-9896	92-8M0078621	18-9400CAT-7P	391-5076	18-0422	398-832075A20	18-5874
91-904551	18-9896	92-8M0078624	18-9440CAT-7	391-5081	18-7143	398-832075A4	18-5870
91-90455T	18-9896	92-8M0078624	18-9440CAT-7P	391-5088	18-5404-1	398-832075A6	18-5873
91-90455T1	18-9896	92-8M0078625	18-9420CAT-2	391-5090	18-5314	398-9610A19	18-5876
91-90774	18-9865	92-8M0078625	18-9420CAT-2P	391-5092	18-5338	398-9873A4	18-5867
91-95830	18-4444	92-8M0078626	18-9420CAT-3	391-5092	18-5338	700-858294T1	18-4639
91-95830A1	18-4444	92-8M0078626	18-9420CAT-3P	391-5093	18-5338	700-858295T1	18-4640
91-99379	18-9802	92-8M0078627	18-9400CAT-2	391-7057	18-5404-1	700-878571A2	18-4641

O.E. #	SIERRA #	O.E. #	SIERRA #	O.E. #	SIERRA #	O.E. #	SIERRA #
MERCURY MARINE cont.		778-9015A2	18-4109	1395-8318	18-7061	1399-1754	18-7832
700-878572A2	18-4642	778-9441A3	18-4109	1395-83181	18-7061	1399-2015	18-7006-1
700-878573A2	18-4643	778-9441A5	18-4134	1395-8506	18-7354	1399-3523	18-7006-1
700-878574A2	18-4644	780-9229A10	18-4621	1395-8673	18-7208	1399-3938	18-7832
733-2278	18-4180	780-9229A11	18-4622	1395-879194024	18-7006-1	1399-5135	18-7007
733-3818	18-4160	780-9229A7	18-4620	1395-8983	18-7208	1399-5137	18-7815
733-38181	18-4160	783-9613A2	18-4017	1395-9022	18-7295	1399-5198	18-7007
733-3819	18-4161	783-9613A3	18-4018	1395-9024	18-7215	1399-99	18-2575
733-3819	18-4191	783-9613T2	18-4017	1395-9179	18-7212	1547-3917A13	18-2450
733-38191	18-4191	783-9613T3	18-4018	1395-9258	18-7057	1547-3917A16	18-2451
733-4028	18-4161	785-9737A10	18-4637	1395-9258 1	18-7057	1547-3917A21	18-2450
733-4028	18-4191	785-9737T9	18-4635	1395-9267	18-36956	1547-3917A30	18-2451
733-66217	18-4180	785-97386	18-7961	1395-9293	18-7209	1547-3917A32	18-2450
733-803850T	18-4161	785-9738T10	18-4638	1395-9377	18-7212	1547-3917A37	18-2450
733-803850T	18-4191	785-9738T9	18-4636	1395-9594	18-7200	1547-3917A38	18-2451
735-6370	18-4173	936-810840	18-4489	1395-95951	18-7062	1547-3917A4	18-2451
735-6370	18-4173	936-986767	18-4489	1395-9599	18-7750-1	1547-3917A8	18-2451
735-6371	18-4164	938-803860T	18-4486	1395-9645	18-7212	1547-5523A11	18-2451
735-6538	18-4181	938-827178	18-4491	1395-9650	18-7226	1547-5523A12	18-2450
735-808661	18-4173	938-883297 1	18-4486	1395-9725	18-7212	1547-5523A2	18-2450
735-808674	18-4173	938-883490	18-4485	1395-9761	18-7212	1547-5523A49	18-2453
735-808674A1	18-4173	938-883490R1	18-4485	1395-97611	18-7212	1547-5523A67	18-2452
735-850097	18-4173	938-883490R50	18-4485	1395-9803	18-7212	1547-5523A67	18-2453
735-850098	18-4164	938-884741R	18-4485	1396-4148	18-7227	1547-5523A68	18-2450
735-9431	18-4164	938-884741R50	18-4485	1396-4656	18-7081	1547-5523A8	18-2451
735-9686	18-4173	1337-2103	18-7078	1396-5222	18-7096	1547-5523A9	18-2450
735-9687	18-4164	1337-2604	18-7078	1396-5238	18-7096	1547-815930A13	18-2419
735-9703	18-4173	13447A1	18-5313-1	1397-2060	18-7200	1547-815930A16	18-2416
735-9704	18-4164	1346-2770	18-7080	1397-2067	18-7746	1547-815930A3	18-2419
735-9715	18-4178	1347-804623A1	18-7605-1	1397-2072	18-7070	1547-815930A6	18-2416
735-97151	18-4178	1347-804623R02	18-7604-1	1397-2133	18-7078	1547-8265A15	18-2450
735-9715T1	18-4178	1347-804623R02	18-7605-1	1397-2150	18-7855	1547-8265A16	18-2451
736-2343	18-4180	1347-804623R1	18-7604-1	1397-2605	18-7078	1547-8265A17	18-2452
737-6523	18-4189	1347-804624 R02	18-7615-1	1397-2631	18-7746	1547-8265A17	18-2453
737-879194035	18-4189	1347-804624 R1	18-7618-1	1397-2634	18-7746	1547-861063A12	18-2416
743-3193A2	18-4620	1347-804624R02	18-7618-1	1397-2637	18-7070	1547-861063A4	18-2411
743-3193A4	18-4620	1347-804624R1	18-7615-1	1397-2637	18-7746	1547-861063A6	18-2419
743-3366A1	18-4621	1347-804625R02	18-7617-1	1397-3306	18-7072	1547-9412A20	18-2450
743-3366A2	18-4621	1347-804625R1	18-7617-1	1397-3327	18-7201	1547-9412A21	18-2451
743-5172A6	18-4620	1347-804626 R02	18-7616-1	1397-3458	18-7071	1547-9412A22	18-2452
743-7716A2	18-4622	1347-816373A4	18-7615-1	1397-3459	18-7746	1547-9412A23	18-2453
759-592010	18-4109	1347-818619	18-7609-1	1397-3462	18-7078	1547-9412A30	18-2450
759-592012	18-4134	1347-818619 1	18-7609-1	1397-3464	18-7070	1547-9412A35	18-2450
759-661010	18-4109	1347-818619 1R02	18-7609-1	1397-3464	18-7746	1547-9412A36	18-2452
759-661012	18-4134	1347-818620	18-7608-1	1397-4329	18-7072	1623-4110A13	18-2443
759-80661A3	18-4109	1347-818620 1	18-7608-1	1397-5635	18-7072	1623-4110A4	18-2443
759-80661A7	18-4109	1347-818620R02	18-7608-1	1397-5830	18-7075	1623-4110A6	18-2443
759-80661A8	18-4134	1347-818621	18-7610-1	1397-5831	18-7075	1623-5356A18	18-2443
759-806661A5	18-4134	1347-818621 1	18-7610-1	1397-5837	18-7202	1623-5356A19	18-2443
759-831210	18-4109	1347-818621 1R02	18-7610-1	1397-6367	18-7076	1623-5356A20	18-2443
759-831212	18-4134	1347-818622	18-7603-1	1397-6367A1	18-7076	1623-5356A3	18-2443
759-8312A2	18-4109	1347-818622 1	18-7603-1	1397-6638	18-7072	1623-5356A4	18-2402
759-8312A6	18-4134	1347-818622R02	18-7603-1	1397-7099	18-7075	1623-815822A3	18-2400
759-9015A4	18-4134	1347-8288A1	18-7616-1	1397-7539	18-7095	1623-815822A32	18-2400
761-7131M	18-4135	1347-8289A1	18-7618-1	1397-7540	18-7095	1623-815822A36	18-2415
761-7133M	18-4135	1347-8460A3	18-7619-1	1397-7542	18-7070	1623-815822A5	18-2400
761-7134M	18-4135	1347-9142A2	18-7619-1	1397-7542	18-7746	1623-815822A53	18-2400
761-7196M	18-4138	1347-9661A3	18-7605-1	1397-7543	18-7070	1623-8951A14	18-2443
761-7197M	18-4138	1347-9863A3	18-7617-1	1397-7543	18-7746	1623-8951A15	18-2401
761-7198M	18-4138	1356-4066	18-7096	1397-7544	18-7095	1623-8951A19	18-2443
761-7982M	18-4135	1356-4092	18-7096	1397-7547	18-7746	1623-8951A2	18-2443
761-7982T	18-4135	1356-5155	18-7096	1397-8535	18-7095	1623-8951A23	18-2443
761-8484M	18-4138	1356-5169	18-7096	1397-8545	18-7869	1623-8951A27	18-2401
765-7443A11	18-4013	1376-5659A1	18-7603-1	1397-8546	18-7201	1623-8951A37	18-2401
765-7443A12	18-4560	1395-4808	18-7006-1	1397-8582	18-7666	1623-8951A43	18-2443
765-7443A2	18-4560	1395-6200	18-7004	1397-8760	18-7075	1623-8951A5	18-2401
765-7446A11	18-4014	1395-6452	18-7005	1397-8767	18-7869	1647-9148T93	18-4832
766-8667A36	18-4565	1395-7824	18-7233	1397-8872	18-7070	1667-9011G59	18-4830
766-8667A43	18-4565	1395-811222	18-7750-1	1397-8872	18-7746	1667-9011R6	18-4850
774-9137A10	18-4515	1395-8112231	18-7211-1	1397-8873	18-7746	2704-812896A2	18-4626
774-9137A14	18-4535	1395-811357	18-7212	1397-8952	18-7077	2704-821896A3	18-4627
776-8898A2	18-4535	1395-811691 2	18-7355	1397-8959	18-7201	2704-821896A4	18-4628
776-9096A1	18-4156	1395-811691 3	18-7356	1397-9723	18-7095	2704-821896A6	18-4626
777-815965A4	18-4623	1395-823635	18-7750-1	1398-3089	18-7080	2704-826191A4	18-4626
777-815965A5	18-4624	1395-8236351	18-7750-1	1399-1136	18-7832	2704-826191A6	18-4626
777-815965A6	18-4625	1395-8236352	18-7750-1	1399-1138	18-7057	2704-826191T4	18-4626
777-815965T4	18-4623	1395-8236353	18-7750-1	1399-1473	18-7057	3302-804844	18-7098-1
		1395-8236354	18-7750-1	1399-1717	18-7006-1	3302-804844001	18-7098-1

O.E. #	SIERRA #	O.E. #	SIERRA #	O.E. #	SIERRA #	O.E. #	SIERRA #
MERCURY MARINE cont.		33149	18-2193	52444	18-7848-1	73813	18-1990
3302-804844002	18-7098-1	33261	18-5838	52731	18-7824-2	73873	18-8227
3302-804845	18-7097	33266	18-5315-1	52731	18-7876-1	74639	18-2753-2
3302-9031	18-7202	33270	18-5717	52999	18-4009	75384	18-5697
3302-9033	18-7859	33316	18-5838	53114	18-2759	75639	18-0615
3302-9437	18-7097	33662	18-5345	54111	18-7824-2	75661	18-5674
3304-9354A2	18-7604-1	33667	18-5385	54111	18-7876-1	75692	18-3553
3310-806969 R01	18-7613-1	33700	18-5310	54534	18-3577-2	75832	18-2104
3310-806969A1	18-7613-1	33706	18-5344	54552	18-7267	75832	18-2174
3310-807312A1	18-7611-2	33707	18-5300	54705	18-3107	76214	18-6016
3310-807312R02	18-7611-2	33708	18-5384	54793	18-3599-2	76214	18-60161
3310-864943A01	18-7639	33765	18-5386	54870	18-1990	76214	18-6016A
3310-866142A03	18-79994N	33981	18-2162	54981	18-5802	76214	18-6244
3310-866142A04	18-79994N	33981	18-2162E	55481	18-7853-1	76270	18-3552
3310-866143A03	18-79995N	34127	18-6012	55989	18-60151-9	76865	18-2130
728374-92605	18-55503	34235	18-5311	56045	18-5956	77123	18-1705
815279-1	18-5741	34282	18-1402	56045	18-5957	77326	18-2144
815279-3	18-5743	34623	18-5899	56153	18-1401	77443	18-2148
815279-5	18-5743	34625	18-5898	56879	18-3584-1	77481	18-2150
819762A4-A7	18-6777	35329	18-4492	57380	18-5650	77594	18-7278
81977A8-A9	18-6777	35341	18-3599-2	57882	18-7232	78016	18-5420
85785-2	18-7229	35583	18-1402	58033	18-5318	78249	18-2143
99186-1	18-6273-1	35884	18-3551	58034	18-5346	78458	18-2760
F694961-1	18-2346	35915	18-3759	58086	18-3584	78477	18-5956
F74305-1	18-7176	35957	18-3593	58217	18-5418	78477	18-5957
6325	18-5345	35983	18-4296	58231	18-5315-1	78485	18-7274
12415	18-5896	35992	18-3752	58749	18-2104	78687	18-2144
12449	18-5957	36147	18-2101	58749	18-2174	78820	18-7275
12449	18-5965	36223	18-2752	59078	18-3550	79448	18-3751
12449	18-5966	36312	18-2104	59137	18-3551	85552	18-2742
12708	18-1240	36312	18-2174	59755	18-5956	86177	18-5658
12784	18-6400	36525	18-5897	59755	18-5957	86234	18-7278
13037	18-5804	37369	18-3593	59972	18-3577-2	86246	18-7274
14244	18-0616	37721	18-0539	60207	18-4008	86247	18-7275
14259	18-0612	37951	18-3599-2	60252	18-4009	86459	18-9099
14586	18-3549	37967	18-2196	60565	18-7875	86814	18-1710
14698	18-2373	37973	18-2150	60658	18-3599-2	87581	18-5315-1
14760	18-0615	38463	18-7878-1	60687	18-5838	88035	18-2372
14957	18-7824-2	38547	18-5433	60930	18-2727	88726	18-8305
14957	18-7876-1	39383	18-2128	61073	18-2196	89876	18-7853-1
16253	18-7381	39384	18-2125	61851	18-1906	89902	18-5838
16755	18-2516	39920	18-1973	62092	18-7267	90794	18-5956
16755	18-2615	41431	18-2104	62092	18-7267	90794	18-5957
17340	18-1400	41431	18-2174	62104	18-2322	90806	18-5899
17437	18-3599-2	41639	18-7230	62424	18-5315-1	90880	18-1905
17646	18-6771	41815	18-7879-1	62981	18-3553	92497	18-5957
17649	18-6772	42785	18-5740	63196	18-7275	92497	18-5965
17670	18-3577-2	42838	18-8305	64850	18-5317	92497	18-5966
18525	18-6771	43023	18-1838	65028	18-2150	92802	18-2733
18717	18-8309	43433	18-2149	65057	18-5802	93320	18-1908
19273	18-7249	43436	18-3754	65142	18-3593	93322	18-1985
19643	18-4261	43557	18-5395	65547	18-1705	93423	18-3199
20121	18-5224	43585	18-1730	65864	18-5420	93424	18-3198
20175	18-2146	43713	18-2724	66062	18-2130	93476	18-0613
20250	18-2015	45523	18-2148	66066	18-2150	93477	18-0615
20311	18-7459	46020	18-2125	66067	18-2286	94318	18-5817
22879	18-2149	46472	18-1402	66071	18-3752	94576	18-3350
25661	18-5836	46692	18-7878-1	66850	18-3553	94916	18-3351
29196	18-8070	46744	18-1402	67209	18-2144	97257	18-5897
29196	18-8084	46860	18-7275	67210	18-2143	97258	18-5898
29880	18-2149	46895	18-3139	67859	18-3577-2	97399	18-7288-1
30605	18-3117	47441	18-1977-1	68100	18-2342	97401	18-7283
31640	18-6011	47585	18-7278	68575	18-5656	99186	18-6273-1
31640	18-6011A	47587	18-1910	69668	18-8305	110990	18-0980
31640	18-6241	47588	18-1910	69729	18-5956	195141	18-5315-1
31659	18-2753-2	47594	18-3557	69729	18-5957	256611	18-5836
32170	18-6013	47638	18-1995	70125	18-7665	316403	18-6011
32435	18-3117	47886	18-5808	70977	18-3113	316404	18-6011
32489	18-3219	48045	18-1990	70981	18-2762	324351	18-3117
32716	18-7824-2	48752	18-3114	71327	18-7278	393831	18-2128
32716	18-7876-1	48753	18-3115	71464	18-7667	428381	18-8305
32717	18-7824-2	49117	18-1402	71646	18-7274	460201	18-2125
32717	18-7876-1	49139	18-3577-2	71683	18-3584-1	573001	18-5603
32722	18-7256	52022	18-7824-2	72625	18-7667	621041	18-2322
32728	18-3551	52022	18-7876-1	72638	18-1402	681001	18-2342
32734	18-2750	52226	18-3599-2	72777	18-3351	684311	18-7083
32768	18-3107	52352	18-5315-1	72778	18-3350	758321	18-2104
		52353	18-3593	73345	18-4233	758321	18-2174

O.E. #	SIERRA #	O.E. #	SIERRA #	O.E. #	SIERRA #	O.E. #	SIERRA #
MERCURY MARINE cont.		850399	18-3599-2	392889925	18-7493	14336A6	18-6752
762142	18-6016	850454	18-3577-2	802630001	18-7663	14336A8	18-6746
774811	18-2150	850458	18-0614	811637001	18-5107-1	14336A8	18-6769-1
802206	18-7116	850484	18-5362	811637002	18-5107-1	14336A9	18-6752
802231	18-7121	850485	18-5408	833072002	18-3537	14336A9	18-6753
802276	18-2013	850487	18-5107-1	833072003	18-3536	14505A2	18-2172
802276	18-2026	853292	18-5852	833072004	18-3537	14586A3	18-43052
802464	18-5107-1	854445	18-7668	850399002	18-3599-2	14698T	18-2373
802630	18-7663	858763	18-7083	850454002	18-3577-2	14698T10	18-2373
802632	18-33104	859168	18-6829	855676002	18-43175	15103A3	18-1137
803148	18-7757	861249	18-7550	864297001	18-7556	16061T	18-5792
803149	18-7697	861260	18-7692	879150150	18-7682	16457A4	18-5395
803470	18-7878-1	861425	18-7551	879194024	18-7006-1	16610M	18-8070
804184	18-7382	861578	18-8297	879194241	18-7964-1	16755A1	18-2516
804412	18-5107-1	862132	18-1711	881693002	18-7698	16755A1	18-2615
804418	18-5354	862209	18-1710	885599004	18-3535	16755Q1	18-2516
804424	18-5408	862998	18-7701	892615001	18-7646	16755Q1	18-2615
804540	18-3638	864493	18-43015	892615002	18-7646	16755T1	18-2615
805100	18-3784	878187	18-7554	898253003	18-5345	16792A33	18-7508
805629	18-5021	878341	18-3599-2	898253005	18-5345	16792A39	18-7508
806105	18-6079	878342	18-3577-2	898253007	18-5318	17177A1	18-5313-1
806105	18-6093	879036	18-2830-1	898253008	18-5418	17340T	18-1400
806105	18-6093A	879078	18-9099	898253009	18-5402	17649T	18-6772
806189	18-6114	879366	18-1194	898253010	18-5405	17693A2	18-7633
806190	18-6092	880817	18-3593	898253011	18-5406	18309A2	18-2412-1
806190	18-6092A	881540	18-7979	898253012	18-5408	18311A17	18-2412-1
806490	18-5897	881731	18-7660	898253013	18-5245	18311A2	18-2412-1
807057	18-5851	882571	18-6948	11497M	18-7833	18312A3	18-2382
808483	18-5354	883514	18-3573	11502M	18-7765	18495A12	18-5790
808484	18-5405	883885	18-3584-1	12076A1	18-1975-1	18495A19	18-5790
809064	18-7748	883925	18-3573	12076A2	18-1972	18495A26	18-5790
809065	18-7749	884727	18-3593	12076A2	18-1975-1	18525A1	18-6771
809066	18-7664	884790	18-5245	12449A1	18-5957	18643A5	18-2323
809462	18-5811	884792	18-5244	12449A1	18-5965	18654A1	18-2750
809463	18-5811	885176	18-7688	12449A1	18-5966	19052A3	18-5791
809569	18-7380	888731	18-5243	12449A1	18-5966	19052A5	18-5791
809910	18-0612	892615	18-7646	12632A3	18-2195	19052A8	18-5791
811091	18-5897	892681	18-33211	12632A4	18-2175	19217A1	18-6777
811536	18-36906	893409	18-3607	12632A6	18-2321	19217A5	18-6777
811549	18-0614	895338	18-3556	12632A7	18-2195	19291A3	18-2370
811573	18-3577-2	934231	18-3199	12644A1	18-4457	19297A3	18-2145
811618	18-6751	934233	18-3199	12644Q01	18-4457	19405A4	18-5432
811628	18-6774	934241	18-3198	12784A10	18-6401	19543A10	18-2157
811635	18-5361	934243	18-3198	12784A4	18-6401	19543A10	18-2159
811636	18-5406	973513	18-2707	12784T	18-6400	19543A10	18-2190
811637	18-5107-1	1100990	18-0980	12886A6	18-1800	19543A10	18-2190E
811639	18-5108	4602002	18-2125	13191A1	18-4221	19543A2	18-2157
811841	18-3599-2	8052732	18-3649	13310T1	18-5674	19543A2	18-2159
814472	18-6275	8055361	18-2097	13330A3	18-8005EP-1	19543A2	18-2190
814755	18-3593	8072521	18-3551	13330A3	18-8005S	19543A2	18-2190E
815425	18-5899	8072522	18-3649	13330Q	18-8005S	19543A2	18-2190E
815471	18-2145E	8072531	18-3551	13524A4	18-5432	19543A4	18-2157
816597	18-3151	8094621	18-5811	13524A5	18-5431	19543A4	18-2159
816607	18-1728	8094631	18-5811	13524A6	18-5432	19543A4	18-2190
816685	18-3749	8107492	18-7213	13524Q06	18-5432	19543A8	18-2157
816770	18-5707	8107493	18-7214	13524T1	18-5431	19543A8	18-2159
816877	18-7083	8168111	18-3752	13753A2	18-5396	19543A8	18-2190
817276	18-3122	8168112	18-3752	14034A3	18-2420	19543A8	18-2190E
817377	18-5475	8168771	18-7083	14034A5	18-2420	19543T1	18-2603
817378	18-5443	8168772	18-7083	14034F1	18-2420	19543T1	18-2603E
821509	18-5852	8168773	18-7083	14034T	18-2420	19543T2	18-2603
821629	18-6080A	8172761	18-3122	14034T10	18-2420	19543T2	18-2603E
821630	18-6094A	8172763	18-3122	14035A3	18-2421	19755A08	18-2196
821630	18-6240	8213542	18-4577	14035A5	18-2421	19755A2	18-2286
822777	18-6014	8227731	18-0202-9	14035F1	18-2421	19755A4	18-2196
823033	18-5182	8227772	18-6014	14035T	18-2421	22831A1	18-8069
823034	18-5793	8235471	18-1839	14035T10	18-2421	22831A3	18-8069
823728	18-7749	8503991	18-3599-2	14244T	18-0616	22831A4	18-8069
824519	18-2346	8504541	18-3577-2	14307T01	18-7328	22831B3	18-8069
826134	18-6068	8504541	18-3577-2	14336A15	18-6752	22831Q3	18-8069
828151	18-5849	8504851	18-5408	14336A17	18-6752	23014A1	18-7804
828708	18-6773	8507521	18-2162	14336A20	18-6274	25661T1	18-5836
834832	18-6454	8507521	18-2162E	14336A20	18-6746	30185A1	18-8070
835076	18-7749	8507522	18-2162	14336A20	18-6746	30185A1	18-8084
846070	18-5817	8507522	18-2162E	14336A22	18-6752	30185A3	18-8070
849899	18-7683	16066004	18-25400	14336A25	18-6746	30185A3	18-8084
849934	18-7682	46020002	18-2125	14336A28	18-6752	30185B3	18-8070
		88245191	18-2346	14336A31	18-6746	30185B3	18-8084

O.E. #	SIERRA #	O.E. #	SIERRA #	O.E. #	SIERRA #	O.E. #	SIERRA #
MERCURY MARINE <i>cont.</i>		43994A2	18-6066A	59826A1	18-2173	75832A1	18-2104
30185Q3	18-8070	43994A2	18-6243	59826A3	18-2173	75832A1	18-2174
30185Q3	18-8084	44354A10	18-1976-2	59829A1	18-9218	75832A2	18-2104
31640A1	18-6011	44354A13	18-1976-2	59830A1	18-2146	75832A2	18-2174
31640A1	18-6011A	44354A3	18-1976-2	59830A5	18-9218	75832A3	18-2104
31640A1	18-6241	44354A9	18-1976-2	59830A7	18-2146	75832A3	18-2174
31640A2	18-6011	45518A1	18-2161	59861A1	18-1993	75832T	18-2104
31640A4	18-6011	45518A2	18-2161	59861A4	18-1993	75832T	18-2174
31640Q4	18-6011A	45518A3	18-2161	60252A2	18-4009	75832T1	18-2104
31640Q4	18-6241	45589A1	18-2169	60372A1	18-1910	75832T1	18-2174
31640T6	18-6011	45589A3	18-2169	60372A2	18-1910	75962A10	18-43052
31640T6	18-6011A	45706A1	18-2142	60426A1	18-1971	75962A11	18-43052
31640T6	18-6241	45706A12	18-2142	60427A2	18-1978	75962A9	18-43052
32170A1	18-6013	45706A14	18-2142	60932A1	18-2751	762142A1	18-6016
32193A2	18-5433	45706A3	18-2142	60932A4	18-2751	76214A5	18-6016
32489A2	18-3219	45706A4	18-2148	62092T	18-7267	76214Q5	18-60161
32492A2	18-2171	45706A6	18-2142	62351A1	18-5707	76214Q5	18-6016A
32492A3	18-2171	45706A8	18-2142	62351A2	18-5707	76214Q5	18-6244
32492A5	18-2171	46020T	18-2125	63115A12	18-7633	76214T3	18-60161
32657A3	18-9099	463999A2	18-6014	63908A2	18-1910	76214T3	18-6016A
32657A4	18-9099	46399A1	18-6014	65057A1	18-5802	76214T3	18-6244
32734A3	18-2750	46399A1	18-6014A	65057T1	18-5802	76270T	18-3552
32992A1	18-2189	47441A1	18-1977-1	65142A1	18-3593	76325A2	18-1972
33662Q	18-5345	47487T	18-5978	65603A12	18-1962-1	76351A04	18-1971
33765T	18-5386	47587A2	18-1910	65603A4	18-1962-1	76351A1	18-1971
33981T	18-2162	47638A1	18-1995	65604A12	18-1958-1	76351A2	18-1971
33981T1	18-2162	47886T	18-5808	65604A4	18-1958-1	76771A2	18-1978
33981T1	18-2162E	48752T	18-3114	66065A1	18-2157	76771A3	18-1978
34086A1	18-2189	49518A1	18-2248	66065A1	18-2159	76850A2	18-2171
34127A1	18-6012	49964A1	18-1971	66065A1	18-2190	77123A1	18-1705
34127A2	18-6012	49964A2	18-1971	66065A1	18-2190E	77234A2	18-1950-1
34127T1	18-6012	52073A1	18-1960-1	66067T	18-2286	77234A7	18-1950-1
34127T2	18-6012	52390A1	18-1955-1	66069A2	18-2157	77235A2	18-1951-1
34235Q1	18-5250	52731A1	18-7824-2	66069A2	18-2159	77235A8	18-1951-1
34235T	18-5311	52731A1	18-7876-1	66069A2	18-2190	77442A1	18-2148
34235T1	18-5250	52969A1	18-1960-1	66069A2	18-2190E	78403A1	18-5956
34762A1	18-6013	53114A1	18-2759	66081A1	18-0577	78403A1	18-5957
34765A1	18-4456	53779A1	18-1978	66081A2	18-0577	78403A2	18-5956
34765A2	18-4456	53779A2	18-1978	66081A4	18-0577	78403A2	18-5957
35187A1	18-2248	54099A1	18-1962-1	66599A1	18-7811	78458A1	18-2760
35187A2	18-2248	54099A5	18-1962-1	66599A2	18-7812	78459A1	18-1993
35187A4	18-2248	54100A1	18-1958-1	66599A3	18-7813	786214A2	18-6016
35993A1	18-0577	54100A5	18-1958-1	67914A2	18-6763	78687T	18-2144
36223A1	18-2752	54293A10	18-5822	68162A1	18-5798	78984A08	18-1993
36223A2	18-2752	54293A13	18-5822	68162A3	18-5797	78984A1	18-1993
37611A1	18-2189	54293A4	18-5822	68162A5	18-5798	79271A4	18-6763
38399A2	18-2189	55278A1	18-7807	68162A6	18-5797	79271A4	18-6768
38965A1	18-2171	55278A3	18-7809	68162A8	18-5798	79271A4	18-6799
38965A2	18-2171	55278A4	18-7809	68521A3	18-5313-1	802128A1	18-7831
39383T	18-2128	55278A5	18-7808	68521A4	18-5313-1	802371A1	18-5181
39920A1	18-1973	55538A2	18-1973	68704A1	18-1148	802630T	18-7663
41141A2	18-7284	55989A3	18-60151-9	69354A1	18-2413	802630T01	18-7663
41155A1	18-9099	55989A3	18-6015-9	69354A2	18-2413	802632T	18-33104
41155A2	18-9099	55989A3	18-6015A-9	70125A02	18-7665	802706A1	18-7738
41639A1	18-7230	55989A3	18-6242-9	70125A1	18-7665	803061T1	18-3569
41951A1	18-2157	55989A4	18-60151-9	70981A3	18-2762	803470Q	18-7878-1
41951A1	18-2159	55989A9	18-60151-9	71464A01	18-7667	803844T01	18-25513
41951A1	18-2190	55989Q9	18-60151-9	71683A1	18-3584-1	804346T1	18-7743
41951A1	18-2190E	55989Q9	18-6015-9	72436A1	18-6011	804483T	18-5354
42419A1	18-6749	55989Q9	18-6015A-9	73020A1	18-2191	805016A1	18-7234
42419A1	18-6749	55989Q9	18-6242-9	73020A14	18-2191	805025A2	18-7326
42419A1	18-6750	55989T9	18-60151-9	73020A20	18-2376	805025A2	18-8867
42431M	18-3426	55989T9	18-6015-9	73345A1	18-4233	805101T	18-3787
42724A3	18-3219	55989T9	18-6015A-9	73679A2	18-2157	805185A36	18-5471
42725A3	18-35437	55989T9	18-6242-9	73679A2	18-2159	805185A37	18-5470
42725A3	18-7282	56211A1	18-2191	73679A2	18-2190	805217A1	18-7684
42909A1	18-7818-1	57882T	18-7232	73679A2	18-2190E	805218T	18-7600
42909A2	18-7818-1	58217Q	18-5418	73723A01	18-2248	805222A1	18-5484-1
42909A3	18-7818-1	58397A2	18-6749	73723A1	18-2248	805223T	18-7702
42909A4	18-7818-1	58397A3	18-6749	73813A1	18-1990	805224A1	18-7632-1
43396A2	18-6249	58759A1	18-1960-1	73813F1	18-1990	805226A1	18-7630
43396A2	18-6249A	58759A10	18-1960-1	73873A1	18-8227	805320A03	18-7633
43432A2	18-2145	58759A13	18-1960-1	74313A4	18-1131	805320A1	18-7633
43557A1	18-5395	58759A14	18-1960-1	74436A9	18-6768	805536A1	18-2097
43567A1	18-1567	59078A1	18-3550	74436A9	18-6799	805536A2	18-2097
43567T1	18-1567	59078T3	18-3650	74639A2	18-2753-2	805544T	18-7703
43994A2	18-6066	59137A1	18-3551	74905A3	18-5313-1	805656A2	18-7326
		59341A1	18-56870	75282A1	18-4221	805656A2	18-8867

O.E. #	SIERRA #	O.E. #	SIERRA #	O.E. #	SIERRA #	O.E. #	SIERRA #
MERCURY MARINE <i>cont.</i>		811618A1	18-6751	821630A1	18-6094A	860349A1	18-33207
805656A5	18-7326	811635Q2	18-5280	821630A1	18-6240	861006A1	18-1989
805656A5	18-8867	811635T3	18-5361	821630C2	18-6094	861155A2	18-8868
805656A6	18-7326	811636 1	18-5406	821630Q1	18-6094A	861155A3	18-8868
805656A6	18-8867	811637T	18-5107-1	821630Q1	18-6240	861155A5	18-7326
805759A1	18-5395	811639T	18-5108	821630T1	18-6094A	861155A5	18-8867
805759A2	18-5395	811673 1	18-6775	821630T1	18-6240	861155A6	18-7326
805759A5	18-5395	81242M	18-3427	821631A1	18-6066	861155A6	18-8867
805759Q3	18-5273	812454A1	18-7288-1	821631B1	18-6066	861156A02	18-8861
805759T	18-5395	812454A3	18-7288-1	821631C	18-6066	861156A03	18-8862
805759T1	18-5395	812843A1	18-6751	821631Q1	18-6066	861156A1	18-35433
805759T3	18-5273	812964A2	18-2412-1	821631Q1	18-6066A	861188A1	18-3531
805884T	18-5965	813442A1	18-6751	821631Q1	18-6243	861245A1	18-7639
80606M	18-7839	813442A2	18-6751	821759A1	18-2354	861249A1	18-7550
806105A1	18-6079	814309A1	18-2434	821759A2	18-2354	861260T	18-7692
806105A1	18-6093	814481M	18-7769	821759A3	18-2354	861493A07	18-1910
806105A1	18-6093A	814819A2	18-9218	821759A4	18-2354	861493A3	18-1910
806105Q1	18-6079	815279A2	18-5741	822777A1	18-6014	861523A9	18-2412-1
806105Q1	18-6093	815407A2	18-5396	822777A1	18-6014A	861676A1	18-35437
806105Q1	18-6093A	815425T	18-5899	822777A3	18-6014	861676T09	18-35437
806105T1	18-6079	815471A3	18-2145	822777A4	18-6014	861676T09	18-7282
806105T1	18-6093	815471A3	18-2145E	822777Q1	18-6014	861677T	18-8860
806105T1	18-6093A	815471A6	18-2145	822777Q1	18-6014A	861678A1	18-7283
806189A1	18-6067	815471A6	18-2145E	822870A1	18-6777	861678A1	18-7283
806189A1	18-6067A	815471T1	18-2604	823034T	18-5793	861771	18-5658
806189A1	18-6114	815471T1	18-2604E	823426A1	18-7072	862030T	18-5983
806189Q1	18-6114	815919A1	18-2320	823426A1	18-7077	862031T	18-6293
806189T1	18-6114	815921A2	18-2353	823427A1	18-7746	862031T1	18-6293
806190A1	18-6089	815922A1	18-2354	823653A5	18-6765	862048A1	18-7288-1
806190A1	18-6092	815922A5	18-2354	823653A9	18-6765	862077A1	18-7284
806190A1	18-6092A	815933A1	18-6080	825096T01	18-5821	862132T	18-1711
806190Q1	18-6092	815933A1	18-6099	825467A1	18-7901	86234A05	18-7278
806190Q1	18-6092A	815935A3	18-2422	825467T1	18-7901	86234A3	18-7278
806190T1	18-6089	815935A7	18-2422	826134A1	18-6068	86234A4	18-7278
806190T1	18-6092	815954A3	18-2423	826763A	18-3154	86246A1	18-7274
806190T1	18-6092A	815954A7	18-2423	828151A1	18-5849	86246T	18-7274
806191T	18-2373	816148A1	18-5313-1	828692A1	18-2382	86247A2	18-7275
806490T	18-5897	816329A3	18-1966-1	828708A1	18-6774	86247T	18-7275
806612T	18-7677	816431A1	18-2747	830250A3	18-6777	862548A1	18-6749
806673T	18-5442	816610A1	18-2244	830250T3	18-6777	862548A1	18-6750
806673T1	18-5442	816610A2	18-2244	832021A1	18-6777	863077T	18-6298
806807A1	18-7691	816770T	18-5707	832021A2	18-6777	863358T	18-43017
806867A 8	18-1956-3	817019A1	18-9099	832021T2	18-6777	86459A1	18-9099
806867A12	18-1966-1	817019A2	18-9099	832021T4	18-6777	86459A2	18-9099
806867A2	18-1966-1	817019Q2	18-9099	833232E	18-4173	864612T01	18-1842
806867A3	18-1966-1	817119A1	18-5957	835392Q	18-15147	864856A1	18-7684
806867A8	18-1966-1	817119A1	18-5965	84141M	18-7840	865202T	18-5851
806867A9	18-1966-1	817119A1	18-5966	84188M	18-3425	865380A03	18-6746
807057T	18-5851	817119A4	18-5957	84188T	18-3425	865380A13	18-6746
807074A1	18-3531	817119A4	18-5965	84262M	18-7837	865436A02	18-2157
807078Q07	18-1957-2	817119A4	18-5966	84265M	18-7838	865436A02	18-2159
807078T08	18-1957-2	817275A08	18-3406	84419M	18-7290	865436A02	18-2190
807166A3	18-2732	817275A09	18-3407	84456M	18-7770	865436A02	18-2190E
807252Q3	18-3646	817275A1	18-3571	84475M	18-7291	865436A03	18-2603
807252Q5	18-3647	817275A2	18-3572	845668T	18-0614	865436A03	18-2603E
807252T1	18-3551	817275K05	18-3147	84829M	18-3426	865437A02	18-2145
807252T2	18-3649	817275T4	18-3147	850484T	18-5362	865493A01	18-6406
807252T6	18-3646	817373A1	18-6094	850484T2	18-5362	865496A01	18-6406
807252T8	18-3647	817377T	18-5475	850484T3	18-5278	865496A01	18-6406
807476A6	18-1908K	817378T	18-5443	85147A5	18-2145	865503T	18-6404
807652T	18-5967	818298A1	18-6249	852956A1	18-7685	865510T	18-6406
807653T	18-5960	818298A1	18-6249A	853678T	18-7700	865511T	18-6406
807757T	18-6457	818298Q1	18-6249	854472A2	18-6777	866169A01	18-8864
807914A1	18-1976-2	818298Q1	18-6249A	854472A3	18-6777	866169T01	18-8864
807929A1	18-2354	818349A1	18-2286	854472A4	18-6777	866170A01	18-8865
807929A2	18-2354	818349T1	18-2286	855654A1	18-6777	86617A20	18-5864
807964A1	18-5476	818763A10	18-2376	855654T2	18-6777	86840A05	18-2756
807988A03	18-1976-2	818763A4	18-2376	855676A1	18-3642	86840A3	18-2756
807988A2	18-1976-2	818903A1	18-6777	857006T	18-6454	87290A4	18-1994
808015T	18-7553	819479A1	18-6777	85784A1	18-7228	87399A1	18-2428
808064A1	18-3531	819480A1	18-6777	85785A2	18-7231	87399A2	18-2428
808483K2	18-5291	821354A2	18-4531	85785T	18-7229	87399A3	18-2429
808483Q2	18-5281	821509T1	18-5852	859168T	18-6829	875285T1	18-6454
808483T3	18-5354	821629A1	18-6080	860235A03	18-1966-1	875286A1	18-6455
808484 1	18-5405	821629A1	18-6080A	860235A04	18-1956-3	875286T	18-6455
809463A1	18-5811	821629A1	18-6099	860246Q11	18-1953-2	87581T	18-5315-1
811536T	18-36906	821629Q1	18-6080A	860256A2	18-3530-1	878265A4	18-6773
		821630A1	18-6094	860256A4	18-3530-1	878265A6	18-6774

O.E. #	SIERRA #	O.E. #	SIERRA #	O.E. #	SIERRA #	O.E. #	SIERRA #
MERCURY MARINE cont.		8M0027721	18-2560	96863A15	18-7633	F7778A9	18-5775
880596T55	18-7338	8M0045604	18-2700	97257A1	18-5897	F8077	18-2945
880596T58	18-7346	8M0054726	18-7660	97258A1	18-5898	F8186	18-2945
881247A1	18-6455	8M0058164	18-7283	97399A2	18-7288-1	F84903	18-1162
881248T	18-6454	8M0058677	18-6157A	97401A2	18-7283	FA84901	18-1162
88183A11	18-6752	8M0060495	18-5247	97401A8	18-7283	FFF001138	18-7964-1
88183A12	18-6752	8M0061335	18-5247	97432A2	18-2414	FI000034	18-1190
88183A12	18-6753	8M0061381	18-1989	97793M	18-3426	FI1001079	18-3593
88183A5	18-6746	8M0062084	18-5408	97793T	18-3426	FI1100014	18-4492
88183A5	18-6769-1	8M0062406	18-2756	98230A1	18-73131	FI1100229	18-0348
88183A6	18-6752	8M0064021	18-6454	98502A2	18-1974-1	FI110026	18-1211
882751A04	18-5850	8M0065179	18-15148	98503A2	18-1970-2	FI110027	18-1211
882751A1	18-5849	8M0065218	18-7347	98504A3	18-1970-2	FI1100305	18-1308
882751A2	18-5849	8M0068784	18-5899	98555A1	18-5957	FI1100349	18-1402
883072T	18-5743	8M0069803	18-7663	98555A1	18-5965	FI1100381	18-1309
883166A1	18-6778	8M0072670	18-15146	98555A1	18-5966	FI1100382	18-1341
883166A2	18-6778	8M0073435	18-35437	98562A6	18-1937	FI1100386	18-3937
88475A4	18-6768	8M0074922	18-43017	98703A11	18-2424	FI1100387	18-3939
88475A4	18-6799	8M0076464	18-43017	98703A12	18-2424	FI1100399	18-1402
884794A02	18-5351	8M0084523	18-6948	98703A17	18-2424	FI110041	18-1211
884794A1	18-5351	8M0084600	18-5224	98703A26	18-2424	FI1100495	18-4492
88553A1	18-6749	8M0089715	18-3551	98703A3	18-2426	FI1100570	18-1308
88678A4	18-7633	8M0090819	18-3633	98704A11	18-2425	FI1100573	18-1309
88678A5	18-7633	8M0091470	18-3649	98704A12	18-2425	FI1100692	18-3937
888733T02	18-7336	8M0095485	18-8212-1	98704A17	18-2425	FI1100694	18-3938
888751A02	18-5350	8M0098795	18-2412-1	98704A26	18-2425	FI1100742	18-3599-2
888751A03	18-5350	8M0104229	18-3016-1	98704A3	18-2427	FI1100779	18-4161
888751A1	18-5350	8M0110717	18-2373	99155A1	18-3555	FI1100779	18-4191
888755A1	18-6158M	8M0117413	18-3640	99155T1	18-3568	FI1100780	18-4161
888755Q01	18-6158M	8M0137769	18-55505	99155T2	18-3555	FI1100780	18-4191
888756A2	18-6150A	8M0142679	18-55505	99186T	18-6273-1	FI1100781	18-4160
888756A2	18-6150Z	8M0708280	18-2425	99297A1	18-2193	FI1100783	18-3939
888756Q01	18-6158A	8M2009865	18-2130	99297A2	18-2193	FI1100785	18-3593
888756Q02	18-6150A	8M6001217	18-5338	993247A4	18-6768	FI1100853	18-1316
888756Q02	18-6150Z	8M6001218	18-5345	99356A2	18-2587	FI1100862	18-1402
888756Q4	18-6150M	8M6001219	18-5303	99370A2	18-2733	FI1100954	18-1402
888756Q4	18-6150Z	8M6001224	18-5404-1	99660A1	18-6751	FI1100968	18-4022
888757Q01	18-6159M	8M6001249	18-5347	99746A17	18-1952-1	FI1100980	18-1334
888758A1	18-6159A	8M6001250	18-5314	99746A8	18-1952-1	FI1100986	18-1233
888758Q01	18-6159A	90363A1	18-7810	99798A16	18-1956-3	FI1100997	18-3577-2
888759A1	18-6159M	90576A4	18-5432	99798A18	18-1966-1	FI1101000	18-0903
888760A1	18-6160M	90746A1	18-5395	99798A18	18-1956-3	FI1101007	18-1339
888760Q01	18-6160M	907964A1	18-5476	99798A3	18-1956-3	FI1101053	18-3577-2
888761A1	18-6160A	90806A1	18-5899	99798A9	18-1956-3	FI1101057	18-3944
888761Q01	18-6160A	91748M	18-7834	F10077105	18-2917	FI1101101	18-4189
888909A1	18-0557	91823A3	18-5313-1	F1348	18-3713	FI1101117	18-4022
88893A4	18-6749	92459A4	18-6765	F17510	18-7413	FI1101134	18-3939
88955A03	18-6454	92497A3	18-5957	F1881	18-3713	FI1101184	18-4173
89031A1	18-7811	92497A3	18-5965	F2769931	18-1402	FI1101185	18-4164
89031A2	18-7812	92520M	18-7293	F2774666	18-3593	FI1101200	18-4024
89031A3	18-7813	92975A28	18-6763	F328506	18-3937	FI1101208	18-3599-2
89031A4	18-7814	92975A32	18-6763	F328516	18-3938	FI1101222	18-1402
891736T	18-6772	92975A6	18-6763	F3746241	18-4492	FI1101236	18-2845
892864T04	18-3631	93247A4	18-6799	F3750884	18-1339	FI1101276	18-2917
892864T06	18-3635	93247A7	18-6768	F3829064	18-1316	FI1101281	18-1237
892874T01	18-8866	93247A7	18-6799	F3860315	18-25001	FI1101287	18-0664
892940T	18-5929	93320A13	18-1908K	F3866612	18-4022	FI1101291	18-2917
893640T01	18-5732	93320A2	18-1908K	F3892364	18-3937	FI1101292	18-3599-2
893929A01	18-6751	93320A3	18-1908K	F3910555	18-1308	FI1101295	18-0612
89396A38	18-8004EP-1	93320A5	18-1908K	F3916351	18-1308	FI1101296	18-0868
89396A38	18-8004S	93320A6	18-1908K	F3932344	18-0874	FI1101297	18-0976
89396Q38	18-8004EP-1	93477T	18-0615	F40109	18-2244	FI1101300	18-0519
89396Q38	18-8004S	94998A1	18-2381	F50342	18-7413	FI1101317	18-4178
896173A01	18-2700	94998A2	18-2381	F50556	18-2945	FI1101318	18-4173
897755T	18-6840	94998A3	18-2381	F508814	18-1129	FI1101320	18-4164
898101T67	18-7337	94998A4	18-2381	F5232670	18-1402	FI1101321	18-3937
898253T22	18-5244	95661M	18-3427	F532555	18-7467	FI1101322	18-3938
898253T23	18-5243	95755A2	18-1970-2	F53795	18-7153	FI1101334	18-4173
898253T24	18-5433	95862A5	18-1954-1	F6269358	18-3577-2	FI1101336	18-4164
898253T27	18-5443	95864A2	18-1975-1	F694555	18-7176	FI1101656	18-0322
898253T28	18-5246	96184A1	18-1567	F694961	18-2346	FI1110294	18-25001
898253T29	18-5247	96455A1	18-5797	F700633	18-4263	FI1110958	18-25001
89876A3	18-7853-1	96455A15	18-5796	F7040	18-3700	FI5000074	18-0889
899106T01	18-8866	96455A6	18-5798	F720301	18-5881	FI5000077	18-0891
		96455A8	18-5797	F724073	18-1300	FI5000078	18-0891
		96455A9	18-5798	F724102	18-1401	FI5000096	18-2917
		96477A3	18-6752	F74305	18-7176	FI5000119	18-2815
		96705A1	18-1955-1	F749301	18-5775	FI5000161	18-2845

O.E. #	SIERRA #	O.E. #	SIERRA #	O.E. #	SIERRA #	O.E. #	SIERRA #
MERCURY MARINE cont.		346871220M	18-7291	125530	18-2881	303069	18-3103
FI5000162	18-0874	346873217M	18-74611	127084	18-4222	303191	18-7413
FI5000178	18-0411	353650210M	18-45404	160084	18-1501	303339	18-2891
FI5000183	18-0411	353760104M	18-6418	171960	18-5898	303345	18-2022
FI5000199	18-2815	369022300M	18-7712	172521	18-5011	303347	18-7180
FI5000200	18-0327	369871221M	18-7765	172522	18-5006	303355	18-2892
FI5000201	18-0887	398873213M	18-74610	172523	18-5002	303360	18-7117
FI5000204	18-2946	3AA050040M	18-51000	172525	18-5001	303438	18-2885
FI5000219	18-0327	3B2-70260-0	18-8089	172527	18-5250	303598	18-7150
FI5000229	18-0348	3B2650160M	18-43212	172531	18-5256	303615	18-0850
FI5000232	18-0868	3B2650211M	18-8920	172543	18-6762	303750	18-2893
FI5000245	18-0348	3B2702501M	18-8088	172543	18-6822	303804	18-2060
FI5000263	18-0868	3B2702810M	18-8079	172588	18-6816	304023	18-2880
FI5005756	18-0876	3B2873222M	18-48317	172806	18-5003	304026	18-3332
FI5110032	18-0153	3B7650212M	18-8924	172850	18-6767-1	304174	18-7165
FI5110037	18-0153	3B7871218M	18-4436	172869	18-5814	304314	18-2894
FI5810151	18-4263	3C7650211M	18-8924	173029	18-6017	304720	18-2951
FI5880010	18-4264	3C8-87121-4	18-4434	173029	18-6017A	304762	18-2871
FI6900023	18-5347	3C8010055M	18-3850	173029	18-6100	304764	18-0882
FI6900031	18-5303	3C8650212M	18-8922	173231	18-7875	305123	18-7133
FI6900031	18-5345	3C8750140M	18-56002	173233	18-7876-1	305176	18-2870
FI6900032	18-5347	3C8760101M	18-6432	173311	18-8055	305185	18-7826
FI6900040	18-5338	3FO-06153-0	18-5182	173312	18-8074	305242	18-7118
FI6900044	18-5407	3FO060491M	18-5182	173326	18-7930	305270	18-7155
FI6900052	18-5385	3FO061530M	18-5182	173564	18-6767-1	305303	18-3102
FI6900083	18-5347	3F3010051M	18-4299	173596	18-6767-1	305306	18-2027
FI6900148	18-5376	3F3871210M	18-4435	173619	18-5251	305312	18-2869
FI6900152	18-5898	3G2-06040-2	18-5166	173690	18-5258	305739	18-7101
FI6900184	18-5369	3GR702500M	18-80410-1	173829	18-5260	305762	18-2532
FI6900185	18-5352	3M3060482M	18-5166	173834	18-7879-1	305987	18-2018
FI6900186	18-5403	3R0-07615-0	18-7911-1	173944	18-6816	306048	18-2959
FI6900189	18-5347	3R0074220M	18-76695	174177	18-8072	306205	18-2901
FI6900190	18-5403	3R3010300M	18-43175	174275	18-9013	306643	18-3135
FI6900198	18-5898	3T9010050M	18-3886	174275	18-9024	307069	18-2957
FI6901224	18-5404-1	3V1010050M	18-60916	174275	18-9065	307082	18-7152
FI8390006	18-7860	3V1010240M	18-60917	174275	18-9080	307103	18-7428
FI9608751	18-7964-1	3V1013030M	18-60918	174448	18-9098	307133	18-2876
FT8935	37509	3V1023050M	18-60919	174508	18-8056	307239	18-7170
MC 1 95862	18-1954-1	3V1060400M	18-23207	174509	18-8014EP-2	307257	18-2872
RA122009	18-5603	3V1871210M	18-64221	174509	18-8014S-1	307450	18-7102
YLM579AV	18-5497-2	65750-95500	18-8079	174511	18-8004EP-1	307551	18-2387
MERCURY/MERCURISER		B29A-90500A	18-6430	174511	18-8004S	307551	18-23871-9
339-883778A01	18-5159	OBERDORFER		174512	18-8005EP-1	307551	18-4255
339-883778A02	18-5159	6603	18-3021	174512	18-8005S	307552	18-2945
339-8M0077473	18-5159	7054	18-3078	175068	18-9013	307573	18-6501
879984A1	18-5158	8922	18-3061	175068	18-9024	307583	18-7106
879984T00	18-5158	132-0317	18-3060	175068	18-9065	307853	18-7120
879984T01	18-5158	B6620	18-3075	175068	18-9080	308186	18-4075
8M0077471	18-5158	C7441	18-3077	175158	18-0871	308458	18-7461
MOTOROLA		OETIKER		175266	18-3715	308500	18-8351
510-802	18-5976	787133	18-9125	175267	18-3716	308621	18-7121
510-821	18-5976	14100082	18-9141	175268	18-3717	308624	18-7103
510-835	18-5976	16700004	18-9126-9	176288	MP28890	308626	18-7198
510-836	18-5976	16700006	18-9127-9	176445	18-8092	308627	18-7104
510-845	18-5975	16700007	18-9128-9	202893	18-7168	308799	18-2863
510-856	18-5976	16700010	18-9129-9	203034	18-2952	308825	18-0653
510-860	18-5975	16700011	18-9130-9	203130	18-3841-2	308876	18-7123
510-861	18-5976	16700012	18-9131-9	203171	18-2886	308928	18-3108
510-862	18-5976	16700013	18-9132-9	203698	18-6513	309044	18-2534
510-864	18-5975	16700016	18-9133-9	277181	18-3001	309243	18-1236
9AR3743G	18-5976	16700017	18-9134-9	300599	18-2035	309612	18-2950
9AR3855G	18-5975	16700020	18-9140-9	300611	18-3326	309731	18-7156
9AR3959G	18-5975	16700024	18-9135-9	301824	18-7111	309955	18-3741
9AR6000G	18-5975	16700024	18-9135-9	301877	18-7100	309956	18-2898
NISSAN		16700031	18-9136-9	301967	18-7440-1	309989	18-2000
3G3060211M	18-5165	16700037	18-9137-9	302325	18-3369	310058	18-0182
NISSAN-TOHATSU		16700040	18-9138-9	302337	18-7162	310137	18-2868
332600052M	18-72656	16700053	18-9139-9	302493	18-7112	310327	18-7173
332600060M	18-60103	OMC		302497	18-3329	310414	18-7167
332600060M	18-72656	114812	18-45312	302537	18-7164	310584	18-7135
334650210M	18-8921	121731	18-3722	302540	18-7114	310585	18-7158
345650210M	18-8923	122838	18-8052	302557	18-2887	310599	18-2012
345871224M	18-7290	123009	18-6017	302588	18-7115	310649	18-2020
346-01032-0	18-60920	123009	18-6017A	302675	18-2889	310913	18-2947
346760100M	18-6431	123009	18-6100	302804	18-3740	310953	18-15460
		123018	18-1599	302994	18-2890	310967	18-7158
		124249	18-8201	303059	18-7134	311046	18-15440
				303067	18-7116		

O.E. #	SIERRA #	O.E. #	SIERRA #	O.E. #	SIERRA #	O.E. #	SIERRA #
OMC cont.		316706	18-4914	320880	18-1219	324639	18-2034
311068	18-2896-1	317178	18-7109	320936	18-0540	324670	18-0110
311069	18-0164	317201	1525607	320943	18-2704	324701	18-2557
311121	18-2861-1	317232	18-2234	320961	18-8353	324717	18-0112
311130	18-2860	317245	18-1243	320981	18-3343	324766	18-0198
311131	18-2859	317305	18-0951	321008	18-2706	324825	18-8204
311145	18-0679	317624	18-1279	321027	18-3563	324937	18-2537
311210	18-3880	317831	18-4290	321028	18-2544	324981	18-7481
311338	18-7105	317838	18-2219	321117	18-7141	325092	18-0118
311508	18-0917	317841	18-3182	321120	18-2536	325211	18-0120
311598	18-4248	317843	18-2026	321163	18-7510	325260	18-0122
311598	18-42481-9	317914	18-2866	321182	18-2545	325273	18-3800
311606	18-15400	317951	18-0953	321183	18-0979	325398	18-3352
311684	18-7854	317955	18-0117	321184	18-2546	325537	18-0124
312456	18-7860	318156	18-0955	321220	18-3565	325647	18-3801
312634	18-2879	318223	18-2059	321221	18-3567	325721	18-2907
312679	18-2900	318303	18-2209	321222	18-3562	326260	18-2862
312780	18-0874	318304	18-2208	321435	18-2549	326264	18-0126
312781	18-71337	318334	18-2872	321459	18-2027	326468	18-0128
312797	18-0398	318335	18-2873	321467	18-2060	326649	18-7174
312797	18-2917	318358	18-2956	321479	18-0981	326716	18-0174
312800	18-0876	318372	18-7137	321481	18-2029	326741	18-7418
312932	18-6511	318373	18-0957	321497	18-0983	326751	18-2075
313065	18-2901	318395	18-3564	321504	18-8351	326765	18-4292
313080	18-2767	318544	18-2378	321573	18-2862	326849	18-7144
313175	18-7107	318544	18-23781-9	321648	18-5655	326877	18-6509
313176	18-3141	318544	18-4249	321692	18-2391	326926	18-1212
313244	18-0923	318609	18-2543	321722	18-0985	326953	18-2888
313258	18-2021	318717	18-7138	321724	18-70936	327031	18-2035
313282	18-2023	318841	18-4222	321727	18-2864	327035	18-2392
313283	18-0173	318914	18-2963	321786	18-2030	327606	18-6018
313284	18-2005	318917	18-0397	321787	18-2031	327655	18-1289
313340	18-7126	318924	18-0959	321788	18-2032	327656	18-0200
313353	18-2058	318925	18-2853	321794	18-0989	327674	18-3899
313368	18-2851	318932	18-0961	321830	18-8304	327707	18-0134
313413	18-2960	318940	18-1505	321831	18-0542	327795	18-3802
313416	18-0929	318944	18-6503	321886	18-3290	327861	18-4280
313446	18-7127	318971	18-3706	321895	18-0543	328283	18-0136
313448	18-1714	318972	18-2025	321907	18-0991	328313	18-1288
313507	18-0543	318973	18-2028	321921	18-7411	328360	18-9885
313754	18-7128	318995	18-3178	321928	18-2033	328361	18-9886
313763	18-2865	319085	18-7139	321932	18-0675	328363	18-9887
313782	18-2884	319097	18-2913	321940	18-3126	328364	18-9888
313893	18-7108	319126	18-3369	322119	18-7133	328365	18-9889
313992	18-2016	319174	18-2867	322119	18-7142	328366	18-9890
314008	18-2703	319256	18-2029	322236	18-4911	328367	18-9891
314082	18-2855	319275	18-3127	322332	18-2962	328506	18-3937
314115	18-0933	319332	18-0967	322411	18-0892	328516	18-3938
314167	18-2024	319348	18-2904	322501	18-7143	328536	18-3940
314322	18-0935	319586	18-0969	322652	18-8020	328590	18-0138
314421	18-2877	319633	18-2954	322653	18-8200	328603	18-8350
314491	18-7129	319661	18-0971	322654	18-8202	328604	18-0140
314502	18-3742	319662	18-7457	322656	18-8051	328622	18-0142
314503	18-3705	319664	18-2093	322858	18-2547	328623	18-3837
314728	18-7130	319665	18-2856	322941	18-3763	328626	18-0144
314730	18-3719	319710	18-2878	323214	18-2550	328751	18-3358
314731	18-0195	319771	18-2857	323217	18-0945	328753	18-2539
314745	18-2231	319890	18-4229	323222	18-0995	328755	18-3359
314809	18-2858	319891	18-3707	323311	18-0446	329076	18-0441
314832	18-2389	319895	18-2287	323312	18-0445	329103	18-2961
314876	18-2874	320041	18-2379	323361	18-2230	329380	18-7416
315052	18-0973	320140	18-7178	323362	18-2229	329381	18-7417
315055	18-0937	320166	18-2224	323459	18-0999-9	329390	18-3360
315189	18-0939	320167	18-2225	323469	18-0102	329419	18-3803
315232	18-7296	320168	18-2226	323582	18-8372	329653	18-8203
315288	18-0542	320169	18-2227	323626	18-3136	329654	18-8034
315538	18-0941	320170	18-2228	323653	18-6522	329718	18-0148
315539	18-2958	320303	18-7140	323664	18-2220	329826	18-0851
315748	18-2705	320305	18-4230	323889	18-2232	329828	18-1205
315810	18-4228	320311	18-2398	323890	18-2233	329830	18-1202
315837	18-3337	320499	18-1377	323943	18-4232	329833	18-1207
315868	18-1218	320533	18-2963	324097	18-3179	329836	18-3836
315869	18-1224	320570	18-4231	324323	18-0106	329920	18-2905
316499	18-0949	320630	18-2220	324324	18-3803	329922	18-2061
316506	18-2243	320658	18-3802	324334	18-4276	329923	18-2062
316563	18-2377	320745	18-2964	324369	18-2399	330081	18-4076
316705	18-4913	320785	18-3743	324430	18-4277	330137	18-2001
		320862	18-2002	324449	18-0108	330273	18-1221

O.E. #	SIERRA #	O.E. #	SIERRA #	O.E. #	SIERRA #	O.E. #	SIERRA #
	OMC cont.	335679	18-2279	379628	18-2192	385662	18-3906
330327	18-2063	335722	18-2277	379763	18-3201	385781	18-7352
330412	18-0155	335818	18-1283	379766	18-3203	385952	18-5697
330525	18-6512	335819	18-1284	379777	18-7801	386084	18-3050
330560	18-3363	335981	18-1507	379957	18-4218	386124	18-3384
330619	18-3295	336232	18-1286	380186	18-7071	386280	18-3933
330621	18-2852	336430	18-0945	380537	18-5345	386430	18-6434
330698	18-0157	336530	18-2709	380538	18-5311	386533	18-3388
330818	18-2963	336562	18-2216	380541	18-5385	386545	MP39100
330854	18-1391	336982	18-42531-9	380542	18-5419	386545	MP39830
330909	18-0159	336982	18-4253-9	380543	18-5310	386573	18-2857
331103	18-8307	337020	18-1290	380640	18-3593	386591	18-5629
331107	18-3299	337068	18-0412	380986	18-7258	386657	18-5648
331188	18-7143	337772	18-2216	381389	18-7200	386659	18-2355
331203	18-2890	337774	18-2216	381494	18-7609-1	386697	18-3327
331211	18-3838	337778	18-1500	381538	18-3059	386764	18-1354
331353	18-7963	338484	18-2557	381668	18-7608-1	386765	18-1355
331363	18-2879	338518	18-7108	381690	18-7860	387041	18-1353
331380	18-7150	338534	18-6522	382045	18-7043	387094	18-5640
331499	18-2908	338813	18-2582	382046	18-7043	387139	18-4040
331532	18-0161	338876	18-2879	382047	18-7043	387142	18-4040
331598	18-0978	338878	18-2908	382049	18-7043	387247	18-1158
331880	18-3765	338879	18-2900	382050	18-7010	387262	18-7093
331916	18-2913	338880	18-2903	382051	18-7010	387277	18-6761
331917	18-2938	338882	18-2579	382052	18-7024	387284	18-4124
331979	18-3133	338884	18-2906	382053	18-7024	387285	18-4114
331980	18-1704	338886	18-2890	382054	18-7010	387326	18-3325
331999	18-4826	339620	18-2074	382057	18-7026	387361	18-3090
332000	18-2769	340115	18-3866	382125	18-5344	387610	18-3327
332010	18-2888	340490	18-2219	382133	18-5375	387656	18-1365
332108	18-2548	340619	18-3455	382135	18-5314	387661	18-4062
332205	18-2064	340975	18-70936	382136	18-5338	387683	18-5674
332253	18-8352	340976	18-70937	382138	18-6754	387684	18-5630
332261	18-2065	341013	18-1598	382218	18-3599-2	387684	18-5630
332266	18-0130	341280	18-8300	382221	18-45221	387787	18-1361
332319	18-0987	341281	18-8301	382296	18-3402	387817	18-1117
332369	18-0977	341440	18-9892	382343	18-1356	387818	18-2252
332403	18-2881	341501	18-0628	382354	18-7352	387879	18-2250
332489	18-2309	342786	18-8325	382363	18-7210	388268	18-7352
332491	18-2308	342787	18-8326	382385	18-3557	388344	18-1378
332584	18-7475	343863	18-1207	382407	18-1351	388517	37478
332585	18-0559	344470	18-3295	382408	18-1366	388602	18-4301
332598	18-7120	346004	18-1723	382468	18-3377	388644	18-3393
332694	18-2900	346150	18-9140-9	382547	18-3082	388644	18-3403
332696	18-2903	346151	18-9135-9	382715	18-6822	388891	18-3238
332816	18-3895	346152	18-9136-9	382733	18-7609-1	389039	18-1358
332817	18-3896	346153	18-9137-9	382821	18-7605-1	389042	18-1370
332819	18-3898	346785	18-9132-9	383052	18-7043	389112	18-3327
333008	18-0975	346786	18-9133-9	383067	18-7043	389143	18-3388
333077	18-2219	346930	18-9126-9	383087	18-7201	389206	18-4307
333096	18-2093	346931	18-9131-9	383307	18-3554	389275	18-5630
333418	18-2906	347107	18-9129-9	383440	18-5711	389275	18-5630
333572	18-7145	347108	18-9130-9	383444	18-5437	389289	18-3059
333592	18-4223	348838	18-9127-9	383587	18-5384	389556	18-4303-1
333670	18-3839	348839	18-9134-9	383615	18-7070	389576	18-3091
333725	18-0197	349516	18-9128-9	383766	18-7605-1	389589	18-3055
333758	18-2708	349729	18-9139-9	383918	18-7095	389642	18-3043
333771	18-0201	349759	18-9138-9	384087	18-3336	389954	18-5634
333879	18-0965	349957	18-9876	384163	18-5630	390055	18-7046
333957	18-1343	352165	18-0313	384163	18-5630	390076	18-4318
334163	18-3766	352670	18-0465	384194	18-7605-1	390078	18-4302
334353	18-0437	353076	18-2075	384195	18-1357	390082	18-3972
334516	18-2216	357159	18-0153	384719	18-3560	390286	18-3366
334665	18-4197	357159	18-0411	384735	18-5418	390381	18-3379
334726	18-3839	370409	18-3944	384743	18-7072	390509	18-3907
334742	18-1734	375638	18-3002	384777	18-5648	390510	18-3908
334897	18-3138	377139	18-1154	384781	18-5671	390641	18-1396
334913	18-7150	377178	18-3003	384848	38653	390770	18-3380
334950	18-8367	377230	18-3083	384884	37509	390905	22355
335334	18-7796	378065	18-3543	384956	18-3376	390928	79040
335359	18-3802	378231	18-5437	385043	18-1371	391170	18-3913
335360	18-2964	378444	18-5807	385068	18-1367	391264	18-6759
335361	18-3801	378891	18-3006	385072	18-3044	391300	18-4303-1
335403	18-1285	378895	18-7093	385356	18-7024	391305	18-7223
335523	18-7110	379312	18-7093	385391	18-5753	391416	18-3915
335633	18-0963	379313	18-7094	385416	18-4300	391472	18-2187
335677	18-9219	379475	18-3086	385503	18-1395	391511	18-5619
		379504	18-1350	385529	18-5634	391635	18-3378

O.E. #	SIERRA #	O.E. #	SIERRA #	O.E. #	SIERRA #	O.E. #	SIERRA #
	OMC cont.	396349	18-2660	432956	18-3387	436888	18-2252
391638	18-7350	396350	18-2656	432962	18-7822	436891	18-4323
391653	18-4101	396351	18-2658	432969	18-4065	436954	18-3129
391698	18-3327	396352	18-2657	432970	18-4066	436957	18-3389
391698	18-3400	396355	18-2659	433003	18-4067	437059	18-3104-1
391735	18-5648	396377	18-3910	433004	18-4068	437090	18-3545
391937	18-7223	396378	18-3911	433017	18-2251	437228	18-0993
391988	18-4304-1	396379	18-3912	433067	18-1721	437327	18-7248
392061	18-7042	396503	18-3906	433190	18-79781	437409	18-4063
392061	18-7222	396504	18-3905	433226	18-6285	437801	18-6280
392123	18-6027	396520	18-7093	433379	18-3643	437907	18-3491
392133	18-5629	396521	18-7093	433386	18-7353	438039	18-1702
392455	18-4123	396522	18-7094	433387	18-7352	438040	18-1703
392462	18-6026	396583	18-4104	433458	18-6025	438399	18-1722
392475	18-1287	396585	18-4100	433503	18-1299	438529	18-6780
392550	18-7046	396587	18-4103	433519	18-7800	438531	18-6780
392567	18-4307	396588	18-4100	433548	18-3394	438555	18-7353
392615	18-4307	396644	18-4529	433549	18-3394	438556	18-7352
392621	18-4107	396701	18-7042	433550	18-2694	438562	18-7351
393023	18-6024	396701	18-7222	433580	18-6115	438591	18-3129
393023	18-6024A	396725	18-3053-1	433935	18-3015	438591	18-3389
393061	18-0466	396750	18-4310	433941	18-4307	438592	18-3394
393088	18-7823	396809	18-3368	434063	18-2218	438592	18-3454
393103	18-7820	396852	18-3015	434107	18-3913	438616	18-7800
393159	18-0153	396932	18-3385	434109	18-3915	438786	18-6281
393271	18-4120	396933	18-3399	434137	18-3500	438996	18-7247
393279	18-9894	396987	18-3557	434381	18-4309	439015	18-4195
393301	MP39760	397003	18-6525	434400	18-1703	439071	18-7043
393433	18-4305	397004	18-6526	434421	18-3390	439072	18-7223
393509	18-3381	397023	18-5619	434421	18-3392	439073	18-7219
393561	18-0927	397131	18-3059	434424	18-3001	439076	18-7046
393566	18-4122	397274	18-7350	434496	18-6780	439077	18-3378
393570	18-5628	397537	18-1363	434588	18-1729	439077	18-3399
393612	18-4102	397538	18-1364	434839	18-7916	439078	18-7248
393630	18-3382	397541	18-2288	434841	18-3543	439079	18-7248
393632	18-3367	397627	18-2310	434844	18-1376	439138	18-2288
393659	18-3543	397768	18-6029	434888	18-7046	439141	18-2623
393896	18-1393	397839	18-7350	435022	18-2251	439476	18-4807
393924	18-4120	398042	18-3708-1	435027	18-3346	439515	18-4165
393988	18-6759	398047	18-4321	435096	18-1703	439516	18-4086
394176	18-6759	398051	18-2093	435276	18-4841	439517	18-4087
394394	18-3401	398319	18-7831	435277	18-4840	439538	18-3947
394408	18-1222	398327	18-7830	435279	18-4843	439561	18-5828
394409	18-3500	398331	18-6025	435390	18-3180	439937	18-6281
394411	18-1506	398338	18-7352	435442	18-7221	439948	18-3059
394461	18-4063	398387	18-7352	435442	18-7247	439967	18-2672
394462	18-1752	398452	18-7223	435443	18-7046	458625	18-0153
394488	18-4148-1	398453	18-7223	435447	18-3390	458625	18-0411
394534	18-3059	398483	18-4064	435491	18-3544	473424	18-1211
394543	18-7352	398514	18-7821	435548	18-6277	500421	37477
394546	18-4306	398526	18-7046	435673	18-3129	500422	37478
394711	18-3327	398532	18-7043	435676	18-7248	500423	37479
394711	18-3400	398549	18-8009EP-2	435677	18-7248	502036	18-1402
394885	18-4309	398549	18-8009S-1	435678	18-7248	502867	18-8063
394930	18-3904	398602	18-1282	435748	18-3059	502880	18-5196
395060	18-3390	398729	18-7042	435752	18-7248	502881	18-5172
395072	18-3391	398729	18-7222	435760	18-2325	502888	18-5192
395073	18-3393	398901	18-1368	435761	18-2328	502890	18-5194
395091	18-7350	431708	18-6095	435821	18-3059	502900	18-7875
395204	18-5825	431708	18-6095A	435929	18-3315-2	502901	18-7876-1
395207	18-5640	431844	18-3974	435957	18-3501	502903	18-7879-1
395209	18-2187	431870	18-3975	435959	18-3405	502904	18-7878-1
395270	18-3383	431897	18-7219	436137	18-8906	502905	18-7846
395270	18-3401	432072	18-4065	436195	18-3561	502905	18-7946
395271	18-3401	432073	18-4066	436232	18-2326	502906	18-7789
395289	18-3051	432077	18-4067	436234	18-2327	502906	18-7989
395419	18-5808	432078	18-4068	436235	18-2330	503747	18-8807-1
395460	18-6501	432230	MP28880	436254	18-3901	503748	18-8800-1
395627	18-1374	432230	MP28900	436353	18-4088	503749	18-8811-1
395713	18-7352	432230	MP28902-1	436354	18-4090	503749	18-8814-1
395861	18-1753	432264	18-1369	436367	18-5886	503749	18-8841-1
395864	18-3059	432451	18-7352	436740	18-2251	503750	18-8801-1
395867	18-7821	432570	18-4322	436745	18-6024	503751	18-8810-1
395911	18-6527	432803	18-4069	436745	18-6024A	503752	18-8802-1
396041	18-1360	432925	18-5612	436746	18-2218	503752	18-8803-2
396161	18-6528	432941	18-3104-1	436834	18-1725	503752	18-8823-1
396235	18-5619	432955	18-3129	436859	18-4079	503753	18-8842-1
		432955	18-3389	436860	18-4190	503754	18-8820-1

O.E. #	SIERRA #	O.E. #	SIERRA #	O.E. #	SIERRA #	O.E. #	SIERRA #
OMC cont.		583266	18-5832	586286	18-5612	908194	18-7400
	18-8802-1	583298	18-5170	586287	18-5612	908237	18-3881
503755	18-8803-2	583380	18-5758	586288	18-5640	908383	18-7401
503755	18-8823-1	583408	18-5708	586343	18-5884	908611	18-2946
503756	18-8843-1	583473	18-5627	586661	18-5781-1	908717	18-0183-1
508105	18-2613	583476	18-5893	586667	18-5893	908765	18-0435
508180	MP39760	583482	18-5624	586696	18-5764	908852	18-2071
508235	1525607	583605	18-5891	586730	18-5801	908894	18-2072
508626	18-3543	583689	18-5832	586731	18-5619	908929	18-15455
508871	18-0348	583737	18-5176	586774	18-5833	908935	18-2850-1
508872	18-0407	583740	18-5170	586842	18-5801	909048	18-7477
508876	18-0411	583748	18-5766	678882	18-7093	909121	18-2183
509395	18-7278	583865	18-5885	740120	18-1922	909314	18-2902-1
509404	18-7283	583896	18-5794	763364	18-7903	909314	18-2902-1-9
509407	18-7282	584028	18-5770-1	763735	18-3090	909316	18-7403
509408	18-7284	584032	18-5771	763793	18-5782	909515	18-0548
509409	18-7274	584037	18-5893	763794	18-5783	909527	18-2768
509410	18-7275	584041	18-5772-1	763794	18-5784-1	909529	18-0947
510364	18-5224	584107	18-6761	763803	18-5774-1	909533	18-3365
510883	18-5226	584122	18-5886	764354	18-9530-3	909613	18-0418
552906	18-3744	584128	18-5813	764357	18-9540-3	909747	18-7404
553126	18-7172	584329	18-5794	764708	18-5755	909748	18-0188
554545	18-7146	584331	18-5794	765012	18-3803	909753	18-2185
580148	18-5156	584416	18-5705	765350	18-3104-1	909758	18-0434
580256	18-5200	584424	18-5832	766779	18-2964	909786	18-0943-2
580290	18-5157	584476	18-5827	766870	18-2950	909818	18-15500
580321	18-5199	584477	18-5181	771839	18-7920	909829	18-0549
580339	18-5750	584488	18-5883	772577	18-4911	909830	18-0550
580740	18-5193	584489	18-5794	772578	18-4913	909835	18-0891
581027	18-5750	584561	18-5176	772579	18-4914	909863	18-1921
581032	18-5194	584580	18-5823	772584	18-5226	909971	18-15460
581130	18-5163	584632	18-5194	772681	18-8063	910048	56507
581207	18-5141	584636	18-5781-1	772681	18-8063	910113	18-0673
581311	18-5753	584641	18-5831	772831	18-7609-1	910139	18-7855
581397	18-5755	584642	18-5773	775518	18-3002	910169	18-5399
581407	18-5196	584643	18-5877	775519	18-3003	910236	18-2911
581419	18-5205	584783	18-5767	775521	18-3006	910305	18-75100
581528	18-5814	584799	18-5619	775613	18-9013	910343	18-15415
581610	18-5192	584818	18-5631	775613	18-9024	910380	18-1922
581713	18-5757	584890	18-5826	775613	18-9065	910384	18-4009
581726	18-5754	584908	18-5768	775613	18-9080	910414	18-15380
581731	18-5753	584980	18-5632	775640	18-8056	910582	18-7174
581778	18-5709	584981	18-5878	775641	18-8092	910641	18-7792
581786	18-5172	584985	18-5887	777120	18-9540-7	910995	18-2216
581805	18-5759	585001	18-5827	777130	18-3086	911019	18-2066
582048	18-6761	585050	18-5648	777213	18-3083	911311	18-7406
582056	18-5756	585051	18-5634	777228	18-9530-7	911616	18-8021
582057	18-5757	585056	18-5624	778885	18-7915-1	911662	18-02062
582091	18-5192	585057	18-5634	778886	18-7896	911663	18-02063
582125	18-5759	585058	18-5648	778887	18-7897	911665	18-02065
582138	18-5760	585059	18-5627	778888	18-7895	911666	18-02066
582155	18-6761	585060	18-5628	778992	18-5640	911667	18-02067
582160	18-5194	585061	18-5629	778994	18-5628	911668	18-0207
582261	18-5764	585062	18-5640	778995	18-5617	911669	18-0209
582285	18-5763	585063	18-5630	778996	18-5631	911669	18-0211
582365	18-5231-1	585114	18-5781-1	787133	18-9125	911670	18-0209
582365	18-8815-1	585134	MP28870	787145	18-9125	911670	18-0211
582365	18-8816-1	585145	18-5774-1	787145	18-9141	911671	18-0209
582365	18-8818-1	585189	18-5780	797407	18-3015	911671	18-0211
582366	18-5176	585219	18-5828	907761	18-0114-1	911672	18-0209
582382	18-5193	585261	18-5785	907764	18-0104	911672	18-0211
582399	18-5708	585267	18-5679	907774	18-3111	911673	18-0209
582400	18-5760	585269	18-5678	907775	18-2883-1	911673	18-0211
582452	18-5758	585459	18-5627	907866	18-3731	911674	18-0209
582453	18-5758	585995	18-5831	907932	18-2830-1	911674	18-0211
582472	18-5705	586000	18-5832	907967	18-2073	911675	18-0209
582508	18-5179	586048	18-5829	908013	18-2875-1	911675	18-0211
582556	18-5760	586075	18-5830	908013	18-2875-1-9	911676	18-0209
582642	18-5760	586212	18-5781-1	908034	18-7859	911676	18-0211
582705	18-5782	586217	18-5893	908062	18-4251	911677	18-0209
582708	18-5808	586224	18-5705	908063	18-2176	911678	18-0211
582811	18-5783	586271	18-5831	908064	18-3725	911678	18-0227
582811	18-5784-1	586274	18-5617	908065	18-2071	911679	18-0229
582995	18-5181	586277	18-5631	908069	18-2177	911680	18-02060
583110	18-5784-1	586279	18-5624	908070	18-2072	911681	18-02061
583114	18-5761	586281	18-5648	908079	18-2912-1	911685	18-2067
583170	18-5763	586284	18-5632	908087	18-2184	911686	18-7169
		586285	18-5628	908158	18-3153	911693	18-1701

O.E. #	SIERRA #	O.E. #	SIERRA #	O.E. #	SIERRA #	O.E. #	SIERRA #
OMC cont.		914743	18-0654	982277	18-6019	984748	18-7634
911698	18-0911	914787	18-15450	982336	18-5369	984765	18-4806
911700	18-7407	914816	18-4161	982342	18-5411	984770	18-4804
911701	18-2068	914817	18-1213	982352	18-7018	984771	18-4805
911702	18-2916	914820	18-1239	982364	18-5957	984876	18-3578
911703	18-3121	914849	18-3877	982384	18-7070	984982	18-5908
911704	18-2541	914899	18-1848	982422	18-1099	985050	18-2218
911705	18-0166	914930	18-3879	982424	18-2186	985052	18-7017
911718	18-7408	914971	18-3876	982438	18-6019	985063	18-5812
911734	18-4837	915025	18-2909	982515	18-3584-1	985064	18-5801
911750	18-4828	915236	18-4160	982517	18-3584-1	985083	18-3937
911751	18-3768	915272	18-2383	982537	18-7081	985218	18-5397
911752	18-3610	915325	18-3887	982539	18-7096	985237	18-6759
911753	18-3769	915326	18-0468	982554	18-3558	985316	18-1401
911787	18-2138	915702	18-2068	982650	18-5899	985429	18-3599-2
911795	18-8349	915716	18-2104	982706	18-6755	985518	18-2674
911797	18-2533	915717	18-2174	982880	18-5403	985560	18-5313-1
911820	18-4250	915719	18-0440	982946	18-2665	985602	18-7278
911823	18-2996	915720	18-4833	982947	18-2664	985603	18-7278
911826	18-2763	915735	18-5433	982949	18-2667	985612	18-2671
911836	18-2918	915840	18-2918	982997	18-7289	985613	18-2672
911844	18-3145	916058	18-2068	983195	18-6257	985630	18-0868
911851	18-7153	916096	18-1922	983218	18-3386	985822	18-7615-1
911871	18-7409	916262	18-0183-1	983247	18-6842	985902	18-5890
911878	18-0880	976669	18-6020	983296	18-3577-2	985966	18-5911
911937	18-3770	979659	18-7072	983298	18-3119	986007	18-5908
912029	18-4835	979719	18-7080	983318	18-6764	986074	18-3577-2
912157	18-0190	979774	18-5803	983424	18-6841	986103	18-0410
912164	18-1204-1	980014	18-1712	983424	18-6842	986104	18-0410
912164	18-1204-1-9	980152	18-5386	983444	18-5911	986120	18-21752-1
912212	18-2146	980183	18-2156	983494	18-6101	986232	18-21754
912213	18-2128	980477	18-3599-2	983538	18-7081	986280	18-6779
912214	18-2104	980528	18-7608-1	983790	18-5911	986336	18-3937
912227	18-3879	980530	18-7609-1	983825	18-1600	986338	18-21751
912374	18-2745	980613	18-5897	983826	18-1601	986364	18-2673
912405	18-0956-1	980617	18-1876	983836	18-6841	986380	18-4806
912418	18-15500	980803	18-5903	983836	18-6842	986381	18-4804
912424	18-75100	980892	18-5407	983855	18-7615-1	986382	18-4805
912441	18-1902	980893	18-5303	983864	18-7095	986423	18-2674
912442	18-1903	980894	18-5347	983870	18-7855	986505	18-5910
912471	18-0431	980902	18-5309-1	983871	18-7201	986629	18-2783
912477	18-0430	980959	18-1904	983877	18-1172	986642	18-5108
912509	18-15435	981078	18-5911	983878	18-1171	986643	18-5361
912614	18-3502	981080	18-5312-1	983880	18-2338	986651	18-5406
912714	18-15520	981195	18-2071	983891	18-1161	986658	18-0647
912766	18-3878	981196	18-2072	983892	18-1170	986779	18-3593
912768	18-0464	981268	18-2073	983895	18-3058	986782	18-7236
912793	18-75125	981288	18-5908	983902	18-21751	986783	18-7235
912954	18-0468	981289	18-5907	983937	18-2100	986784	18-7237
912955	18-0405	981359	18-7615-1	983967	18-4750	986796	18-7238
912965	18-2845	981428	18-7615-1	983973	18-2765	986799	18-7237
912978	18-4408	981564	18-7615-1	984012	18-1602	986800	18-7239
912979	18-1238	981566	18-7229	984054	18-1901	986804	18-7241
912981	18-0347	981650	18-7268	984180	18-7609-1	986865	18-7229
912988	18-0887	981705	18-7615-1	984264	18-6399	987136	18-5303
912989	18-1213	981797	18-2663	984290	18-21752-1	987251	18-2791
913270	18-0664	981799	18-2666	984356	18-6814	987313	18-7242
913275	18-0887	981801	18-2669	984360	18-3593	987315	18-7243
913276	18-2815	981803	18-7615-1	984398	18-5353	987317	18-7244
913277	18-0347	981821	18-5903	984401	18-5352	987319	18-7245
913393	18-0401	981911	18-7861	984456	18-5910	987438	18-7246
913488	18-75100	982019	18-6950	984458	18-2672	987440	18-7246
913745	18-0528	982058	18-6755	984459	18-2673	987447	18-3577-2
913758	18-0352	982063	18-7267	984461	18-3212-1	987467	18-2765
913783	18-0943-2	982069	18-6764	984461	18-3348	987485	18-7246
913783	18-0943-2-9	982073	18-6764	984487	18-7086	987603	18-2673
913784	18-1909-1	982121	18-5911	984491	18-7854	987661	18-2245-1
914036	18-2764	982132	18-2595	984513	18-6028	987678	18-2246
914323	18-0518	982195	18-5908	984513	18-6028A	987738	18-5888
914445	18-4024	982202	18-5907	984513	18-6102	987739	18-5889
914488	18-8369	982209	18-5376	984536	18-6270	987740	18-5890
914555	18-3937	982211	18-5404-1	984536	18-6276	987774	18-6261
914556	18-3939	982217	18-7608-1	984537	18-21754	987784	18-1922
914557	18-3938	982217	18-7609-1	984547	18-6103	987811	18-5920
914716	18-2383	982219	18-7608-1	984547	18-6103A	987894	18-5303
914723	18-0652	982223	18-7615-1	984628	18-5917	987895	18-5347
914736	18-0655	982230	18-7862	984629	18-21755	987925	18-5258
		982240	18-7278	984744	18-3206	987926	18-5260

O.E. #	SIERRA #	O.E. #	SIERRA #	O.E. #	SIERRA #	O.E. #	SIERRA #
OMC cont.		3853818	18-6028	5000309	18-8383	R077002	18-7824-2
987986	18-5413	3853818	18-6028A	5000356	18-4801	R084003	18-7697
988013	18-6270	3853818	18-6102	5000363	18-1703	R094020A	18-2702-1
988013	18-6276	3853827	18-1230	5000581	18-6528	R096116	18-4220
988037	18-7330	3853847	18-1401	5001036	18-3546	R096117	18-3200
988162	18-0410	3853850	18-3599-2	5001344	18-5768	R103001	18-5404-1
988217	18-5919	3853862	18-21753	5001593	18-3059	R103003	18-5407
988247	18-6841	3853912	18-0410	5001594	18-3390	R103004	18-5403
989966	18-2218	3853913	18-0410	5001594	18-3392	R103011	18-5245
1984462	18-5717	3853917	18-21752-1	5001595	18-3315-2	R108001	18-5376
3850216	18-5811	3853945	18-6779	5004257	18-1703	R114001	18-5314
3850357	18-7677	3853960	18-3937	5004705	18-4148-1	R114002	18-5303
3850379	18-1238	3853962	18-21751	5005113	18-6802	R114004	18-5314
3850396	18-7684	3854001	18-5108	5005114	18-6801	R115001	18-5338
3850426	18-1074	3854002	18-5443	5005115	18-6803	R115002	18-5345
3850456	18-1909-1	3854003	18-5107-1	5005254	18-6281	R117001	18-5433
3850495	18-2875-1	3854017	18-3593	5005266	18-7722	R117012	18-7648
3850495	18-2875-1-9	3854033	18-1402	5005440	18-3543	R119001	18-5450
3850496	18-0943-2	3854072	18-30585	5006319	18-6744	R130001	18-5801
3850595	18-0893	3854095	18-1231	5006373	18-8384	R130012	18-15214
3850597	18-2791	3854118	18-3577-2	5006511	18-3453	R142006	18-2434
3850799	18-1922	3854127	18-2765	5007556	18-3476	RA057004	18-3584-1
3850809	18-7326	3854158	18-7601	5007662	18-6803	RA057018	18-3599-2
3850810	18-7331	3854182	18-6261	5007972	18-3472	RA057019	18-3577-2
3850812	18-2174	3854190	18-5920	5008968	18-8905	RA057023	18-3586-1
3850813	18-2128	3854194	18-6291	5008972	18-4537	RA057024	18-3587-1
3850814	18-2337	3854217	18-5248	5030087	18-3735	RA057036	18-42608
3850815	18-2146	3854252	18-3939	5030699	18-3499	RA097002	18-5957
3852109	18-0874	3854269	18-0868	5030973	18-74108	RA097003	18-5957
3852111	18-0398	3854280	18-7330	5031411	18-7915-1	RA097006	18-5957
3852113	18-0876	3854286	18-3060	5031417	18-8904	RA097007B	18-5984
3852215	18-5894	3854299	18-3879	5031456	18-8337	RA097007B	18-6288
3852338	18-1848	3854311	18-5408	5032238	18-7719	RA097007C	18-6453
3852350	18-4194	3854331	18-5362	5032323	18-7716	RA097009	18-6452
3852374	18-1986-1	3854406	18-0410	5032424	18-7773	RA107001	18-5309-1
3852384	18-2339	3854512	18-7703	5033102	18-7903	RA108002	18-5369
3852455	18-0183-1	3854539	18-2454	5033112	18-3099	RA108003	18-5352
3852477	18-0891	3854548	18-5354	5033372	18-3497	RA108009	18-5244
3852531	18-7407	3854549	18-5405	5033539	18-7896	RA122001	18-5903
3852548	18-8349	3854620	18-7326	5033542	18-8907	RA122001	18-5920
3852560	18-2996	3854661	18-3469	5033919	18-7897	RA122008	18-5907
3852563	18-1713	3854751	18-5913-1	5035703	18-7895	RA122009	18-5603-1
3852565	18-7153	3854809	18-6261	5035974	18-7953	RA122009	18-5908
3852568	18-4749-9	3854905	18-7679	5036216	18-3498	RA122019	18-6443
3852648	18-3730	3854942	18-0311	5031417	18-3096	RK122014	18-5920
3852654	18-0468	3854956	18-0518	173232, 502902	18-7824-2	RM0002	18-0677-1
3852655	18-0405	3855104	18-7792	173232, 502902	18-7824-2	RM0003	18-0878
3852656	18-0322	3855182	18-7689	584605, 586275	18-6863	RM0007	18-0183-1
3852657	18-0519	3855270	18-1909-1	85R-4541	18-7096	RM0017	18-0898
3852687	18-0664	3855412	18-6028	OMC / BOMBARDIER		RM0032	18-3883
3852691	18-0887	3855412	18-6028A	336226	18-0694	RM0099	18-0676-1
3852692	18-2815	3855412	18-6102	336227	18-0693	RN0067	18-7227
3852693	18-0347	3855958	18-7330	336388	18-0696	RN0116	18-7081
3852696	18-2779	3856127	18-1400	336389	18-0695	RN0116-2	18-7081
3852741	18-2780-1	3856138	18-1237	339601	18-0692	RN0118	18-7096
3852742	18-2781	3856444	18-1909-1	340919	18-0492	RN0118-1	18-7017
3852824	18-0147	3856600	18-6261	346007	18-0491	RN0120	18-7096
3853132	18-0518	3857561	18-6261	347205	18-0690	RN0120-1	18-7017
3853226	18-4024	3857650	18-7330	437155	18-4406	RO20001	18-5899
3853256	18-0680	3857656	18-1848	437725	18-4428	RO28001	18-1996
3853268	18-3937	3857723	18-1986-1	437779	18-4420	RO29001	18-1899
3853336	18-2946	3857944	18-1909-1	439202	18-4420	RO85035	18-2103
3853340	18-4161	3857985	18-7331	5000400	18-4421	RO96081	18-4214
3853341	18-1213	3857986	18-7326	PERKINS		RP026002E	18-3671
3853342	18-0327	3858261	18-7326	2654403	18-7886	RP061015	18-3060
3853361	18-0903	3858340	18-3593	185086600	18-6944	RP061017	18-3061
3853380	18-3876	3858437	18-21752-1	2871A651	18-5975	RP080026	18-8127
3853477	18-4160	3858714	18-7331	PLEASURECRAFT		POLARIS	
3853510	18-1232	3860095	18-1233	3705042	18-0889	3240120	18-15080
3853511	18-3874	3860171	18-6261	9-37824	18-7976	PS-4	72-5104-2
3853512	18-0468	3911020	18-4173	R017066	18-3700	PS-4	72-5104-3
3853528	18-1234	3911023	18-4164	R020027	18-7677	PS-4	72-5104-7
3853655	18-2068	3921473	18-0466	R020035A	18-7646	VES	72-5103-2
3853732	18-3883	3923440	18-0466	R026002E	18-3551	VES	72-5103-3
3853742	18-0183-1	3930912	18-0346	R047111	18-7480	VES	72-5103-4
3853796	18-3584-1	3931593	18-0348	R077001	18-7875	VES	72-5103-5
3853799	18-3558	3935449	18-0980			VES	72-5103-7
		5000074	18-1702				

O.E. #	SIERRA #	O.E. #	SIERRA #	O.E. #	SIERRA #	O.E. #	SIERRA #
POWER POLE		17059289	18-7618-1	09284-08003	18-0569	16510-82703	18-7897
PUMP PRO-F	18-6819	17059290	18-7616-1	09289-10002	18-0545	16510-87J00	18-7915-1
PUMP SPN-F	18-6818	17059291	18-7605-1	09289-22007	18-8345	16510-93J00	18-7895
PRESTOLITE		17059292	18-7605-1	09381-14001	18-42940-9	16510-96J00	18-7905-1
873051	18-6881	17059298	18-7619-1	09381-18002	18-42950-9	17400-87D11	18-3253
110-258	18-6955	17068453	18-7855	09381-20003	18-42960-9	17400-87E03	18-3254
110-258A	18-6955	17078904	18-7854	09420-03005	18-3292	17400-87E04	18-3254
15-79	18-5840	17080560	18-7616-1	09420-04009	18-3404	17400-90J11	18-3258
ETK	4001	17080561	18-7615-1	09420-05005	18-3296	17400-90J20	18-3258
ETK	4101	17080561	18-7618-1	09420-05006	18-3291	17400-92D01	18-3255
ETK	4102	17080562	18-7618-1	09420-05009	18-3291	17400-93951	18-3256
EVD	4001	17080564	18-7605-1	11141-87D60	18-3825	17400-93J00	18-3264
EVD	4002	17080565	18-7605-1	11141-87D90	18-3825	17400-93J02	18-3264
HYK4001	18-6274	17081060	18-7610-1	11141-87E10	18-3822	17400-94611	18-3257
SAW4201	18-5840	17081299	18-7619-1	11141-87E90	18-3822	17400-94700	18-3243
SAW4206	18-5807	17082403	18-7607-1	11141-93901	18-3808	17400-94701	18-3243
SAW4207	18-5840	17083522	18-7619-1	11141-93960	18-3808	17400-95350	18-3244
SAW4210	18-5840	17085013	18-7615-1	11141-94401	18-3810	17400-95351	18-3244
VSH-6201	AFY	SEA-DOO		11141-94450	18-3810	17400-95550	18-3244
VSH-6201JY	18-5710	278-000-123	18-6878	11141-94506	18-3823	17400-96350	18-3242
RACOR		278-000-186	18-6868	11141-94600	18-3824	17400-96351	18-3242
2010PM-OR	18-99183	278-000-311	18-6868	11141-94620	18-3823	17400-96353	18-3242
2010SM-OR	18-99186	278-000-316	18-6868	11141-94620	18-3824	17400-98551	18-3259
2010TM-OR	18-99182	278-000-484	18-6867	11141-94701	18-3820	17400-98652	18-3260
2020N-02	18-99187	278-000-485	18-6867	11141-94702	18-3820	17400-98661	18-3266
2020N-10	18-99181	278-000-576	18-6866	11141-94720	18-3820	17400-98J00	18-3267
2020N-30	18-99180	278-000-577	18-6866	11141-95305	18-3813	17400-98J01	18-3267
2040N-02	18-99191	278-001-038	18-6866	11141-95320	18-3813	17411-93901	18-3480
2040N-10	18-99185	278-001-239	18-6879	11141-95505	18-3814	17411-94421	18-3481
2040N-30	18-99184	278-001-292	18-6871	11141-95512	18-3814	17461-87E11	18-3049
6H3-W0001-02	18-99176	278-001-300	18-6867	11141-95D10	18-3819	17461-87E12	18-3049
B32013	18-7928-1	278-001-301	18-6866	11141-95D90	18-3819	17461-90J00	18-3023
B32020MAM	18-7929	278-001-376	18-6859	11141-96303	18-3809	17461-90J01	18-3023
R12P	18-99199	278-001-497	18-6869	11141-96344	18-3809	17461-92D02	18-3000
R12S	18-99194	278-001-554	18-6876	11141-98101	18-3807	17461-93001	18-3092
R12T	18-99193	278-001-581	18-6874	11141-98130	18-3807	17461-93003	18-3092
R20P	18-99200	278-001-802	18-6859	11141-98401	18-3806	17461-93004	18-3092
R20S	18-99196	278-001-935	18-6867	11141-98411	18-3806	17461-93901	18-3099
RK10012	18-7394	278-001-936	18-6869	11141-98504	18-3816	17461-93902	18-3099
RK10215	18-99201	278-002-199	18-1294	11141-98510	18-3816	17461-93903	18-3099
RK10222	18-7987	290-888-993	18-6905	11141-98522	18-3816	17461-93J00	18-3035
RK22244	18-0179	290-888-999	18-6905	12110-93120	18-40140	17461-94500	18-3023
RK22368	18-99203	420-888-9933	18-6905	12110-94400	18-40110	17461-94501	18-3023
RK22628	18-9884	420-888-994	18-6905	12140-93121	18-39480	17461-94502	18-3023
S3213	18-7919	420-888-996	18-6905	12140-94400	18-39540	17461-94503	18-3023
S3214	18-7920	SHERWOOD PUMP		12151-92502	18-42870	17461-94504	18-3023
S3227	18-7948	9959	18-3060	12151-93100	18-42860	17461-94505	18-3023
S3232	18-7949	10615	18-3061	12151-94400	18-42850	17461-94506	18-3023
S3240	18-7947	10927	18-3168	12161-91L00	18-1758	17461-94510	18-3023
ROCHESTER		10931	18-3140	12161-92L00	18-1759	17461-94511	18-3023
1708563	18-7616-1	12322	18-3169	12161-93902	18-1757K	17461-94520	18-3023
7036543	18-7609-1	12859	18-3169	12161-93902	18-1757K	17461-94700	18-3094
7040080	18-7608-1	18200	18-3077	12161-94400	18-1759	17461-94701	18-3094
7040082	18-7609-1	10615K	18-3047	12161-94400	18-1759K	17461-95300	18-3095
7040083	18-7608-1	9959K	18-3046	12161-96300	18-1758	17461-95301	18-3095
7040089	18-7608-1	9979K	18-3079	12410-96351-050	18-39530	17461-95302	18-3095
7041369	18-7609-1	SKI-DOO		13119-91J00	18-0792	17461-96301	18-3096
7042183	18-7608-1	XPS 779126	72-5103-2	13910-87D00	18-7752	17461-96311	18-3096
7043182	18-7609-1	XPS 779127	72-5103-3	13910-89J01	18-7773	17461-96312	18-3096
7043183	18-7608-1	SUZUKI		13910-94400	18-7753	17461-98501	18-3097
7043184	18-7608-1	09141-14008	18-3710	13910-94701	18-7754	17461-98502	18-3097
7044182	18-7609-1	09141-18005	18-3726	13910-95D00	18-7755	17461-98503	18-3097
7044185	18-7603-1	09168-10022	18-8331	15170-91J00	18-3497	17461-985M0	18-3097
7044291	18-7618-1	09204-02004	18-3737	15170-93911	18-3495	17462-93990	18-3292
17057283	18-7605-1	09204-03003	18-3735	15170-94320	18-3496	17471-87D01	18-3189
17057285	18-7605-1	09204-03004	18-3735	15170-94J00	18-3498	17471-87E01	18-3192
17057287	18-7616-1	09263-14022	18-1414	15170-94JOV	18-3498	17471-92D10	18-3193
17057298	18-7615-1	09263-18016	18-1415	15170-99E00	18-3499	17471-92J00	18-3192
17059052	18-7608-1	09263-20051	18-1412	15200-96J00	18-7348	17471-93902	18-3190
17059054	18-7609-1	09263-20072	18-1417	15410-87J10	18-7716	17471-94501	18-3191
17059057	18-7608-1	09263-27005	18-1416	15410-87J30	18-7953	17471-98503	18-3188
17059280	18-7615-1	09280-08008	18-7118	15410-94400	18-7735	17472-91J00	18-0761
17059280	18-7617-1	09280-75002	18-7140	15410-96J00	18-7711	17472-92D10	18-0479
17059283	18-7619-1	09282-24004	18-0544	15410-98500	18-7719	17472-93911	18-0478
17059287	18-7616-1	09282-30007	18-0546	15412-93J00	18-7936	17472-93J00	18-0778
17059288	18-7615-1	09283-10011	18-0551	16510-05240	18-7903	17472-95200	18-0459
				16510-45H10	18-8870	17472-95310	18-0460
				16510-61A20-MHL	18-7896	17472-96301	18-0461

O.E. #	SIERRA #	O.E. #	SIERRA #	O.E. #	SIERRA #	O.E. #	SIERRA #
SUZUKI cont.							
17472-98503	18-0477-9	65750-94404	18-80418	430020	18-2994	835304	18-5314
17472-98611	18-0480	65750-95500	18-8079	430039	18-2924	835308	18-5338
17472-98J00	18-0651	65750-95510	18-8079	430143	18-7878-1	835390	18-3599-2
17582-93J00	18-0793	65750-98505	18-8062	430172	18-2526	835417	18-0398
17685-87D10	18-0797	990C0-10W40-1GL	18-9551-3	461092	18-2925	835440	18-7824-2
17685-97J00	18-0794	990C0-10W40-1QT	18-9551-2	461511	18-1479	835512	18-3060
17685-98J00	18-0795	99105-00192	18-8071	462623	18-2966	835576	18-7859
17685-99E00	18-0796	99105-00193	18-8078	463377	18-4029	835702	18-5369
18213-98J00	18-32154	99105-20004-BWL	18-7922-1	463505	18-7890	835704	18-5345
25223-94400	18-8334	99105-20005	18-7948	463587	18-2926	835705	18-5303
25700-87D00	18-8335	99105-20006	18-7947	463902	18-4245	835804	18-1931-1
25700-90J01	18-8373	99105-20006-BWL	18-7987	463999	18-2927	835874	18-3047
25700-92J00	18-8374	TOHATSU		466634	18-7880	835874	18-3061
25700-93J00	18-8380	369060210M	18-5143	466987	18-7942	835966	18-2949
25700-94400	18-8337	3A0060401M	18-5133	477024	18-4200	835998	18-5433
25700-94500	18-8338	3A0060481M	18-5133	477556	18-0034	837924	18-6872
25700-94700	18-8339	3G2060602M	18-5134	502036	18-1402	838513	18-70704
25700-95500	18-8340	UNIVERSAL		803762	18-1727	838637	18-4466
25700-95D00	18-8341	288182	18-6263	804190	18-0184	838638	18-4471
25700-95J00	18-8385	288759	18-6263	804261	18-4259	838928	18-6021
25700-98J00	18-8386	299381	18-7884	804695	18-2039	838929	18-6001
25700-99E00	18-8381	301068	18-6140	806256	18-3106	839423	18-4208
31100-89J00	18-6419	301069	18-6141	807036	18-4216	839430	18-6790
31100-90J00	18-6831	VALEO		808007	18-3274	839534	18-4209
31100-92E00	18-6417	541663	18-5943	812994	18-4150	840808	18-5906
31100-93J00	18-6941	2541451	18-5939	813967	18-8368	841070	18-5352
31100-94600	18-6827	2937430	18-5976	814301	18-2153	841161	18-7286
31100-94601	18-6827	2939590	18-5975	814356	18-2939	841162	18-7862
31100-94610	18-6416	A0002655299	18-6848	818525	18-5419	841177	18-6268
31100-94610	18-6827	A13N147M	18-5959	820545	18-6822	841207	18-3876
31100-94702	18-6429	A13N148M	18-5959	820652	18-59710	841243	18-5411
31100-95313	18-6428	A13N148M	18-5959	822454	18-59710	841244	18-5375
31100-95600	18-6414	A13N1M	18-5959	824633	18-2928	841262	18-5349
31100-95J00	18-6945	A13N234	18-5939	824677	18-2989	841263	18-5358
31100-95J01	18-6945	A13N259	18-5943	824803	18-7099	841292	18-7000
31100-96J00	18-6941	A13N2M	18-5959	826341	18-4204	841380	18-59700
31100-96J01	18-6941	VOLVO		826423	18-75125	841640	18-3586-1
31173-95310	18-56008	35254	18-5436	826493	18-7281	841750	18-7879-1
31173-99E00	18-56009	72021	18-6846	826495	18-5959	841762	18-5959
32140-93900	18-5152	82745	18-4218	826648	18-7888	841762	18-59700
32900-93911	18-5144	125017	18-7178	827247	18-2045	841763	18-59700
33410-92L10	18-5151	174448	18-9098	827303	18-59710	841765	18-5959
33410-94400	18-5151	181620	18-2057	829207	18-15460	841765	18-59700
37100-87J00-OEP	18-18304	192212	18-4201	829592	18-4219	841766	18-5959
37110-99-E00	MP51010	233991	18-6872	829620	18-4464	841766	18-59700
37110-99-E00	MP51012	240149	18-5306	829714	18-2934	841821	18-15430
38100-87000-OIT	18-6785	240501	18-6872	829913	18-8124	841907	18-5403
38100-87D10-OED	18-6786-1	241669	18-5393	831009	18-3106	841926	18-5353
38100-87D10-OIT	18-6786-1	241812	18-6271	831617	18-2527	841994	18-7086
38100-87D10-35J	18-6786-1	243460	18-5305	831622	18-2519	842775	18-6872
38100-87E10-OED	18-6785	243632	18-5357	831891	18-2528	843511	18-6872
38100-87E20-OED	18-6785	243653	18-5342	831892	18-2529	845363	18-28050
38100-87JOEP	18-18304	243658	18-5394	832570	18-4206	845792	18-75125
38100-87J11	18-6793	243797	18-5356	832598	18-6000	845940	18-6846
38100-87J20	18-6793	243799	18-5305	832598	18-6000A	847651	18-59710
38100-92E00-OED	18-6786-1	243801	18-5319	832598	18-6104	847741	18-0032
38100-92J02	18-18303	243903	18-5428	832669	18-2990	849561	18-59710
38100-92J10	18-18303	243903	18-5428	832675	18-2199	849602	18-59710
38100-93J01	18-18303	273663	18-7783	832820	18-4205	850046	18-6791
38100-93J02	18-18303	324825	18-8204	832831	18-2776	850785	18-4210
38100-96J00	18-18303	328516	18-3938	832846	18-2778	850834	18-6758
38860-76F01	18-5731	329653	18-8203	832965	18-4234	850888	18-4211
55125-87D00	18-6033	370409	18-3944	833188	18-4463	850889	18-4212
55125-96310	18-6098	416033	18-2933	833274	18-3842	851120	18-6951
55320-95310	18-6032	418265	18-2974	833453	18-3834	851261	18-4213
56132-95J00	18-0650	418411	18-2935	833950	18-4005	851407	18-0558
57630-92E00	18-3775	418412	18-2937	833995	18-3076	852520	18-6791
57630-94300	18-3777	418445	18-2936	833996	18-2044	852835	18-6004
57630-94500	18-3774	418870	18-2922	834337	18-7884	852835	18-6004A
57630-96300	18-3778	419310	18-2965	834476	18-2531	852835	18-6105
65720-94401	18-80409	419652	18-4474	834520	18-5806	852928	18-6274
65720-94411	18-8087	419653	18-4473	834548	18-4044	852928	18-6838
65720-986B0	18-80425	419678	18-2923	834560	18-5348	852928	18-6881
65740-95500	18-8078	419734	18-4468	834609	18-5959	852928	18-6822
65750-87J10	18-80419	419735	18-4470	834751	18-2766	853012	18-710-64-2
65750-87J11	18-80419	423135	18-7926	834893	18-5911	853255	18-2104
		430017	18-2518	834963	18-5959	853548	18-7306
		430018	18-2525	834975	18-5425	853670	18-2040

O.E. #	SIERRA #	O.E. #	SIERRA #	O.E. #	SIERRA #	O.E. #	SIERRA #
VOLVO cont.		875407	18-7085	908611	18-2946	3854003	18-5107-1
853868	18-25251	875422	18-2596	912213	18-2128	3854017	18-3593
854031	18-2777	875550	18-2793	912227	18-3879	3854018	18-36905
854045	18-4210	875569	18-2982	912957	18-0519	3854020	18-7238
854047	18-4213	875571	18-8813-1	912979	18-1238	3854026	18-7229
854329	18-6792	875574	18-3205	914323	18-0518	3854033	18-1402
854346	18-6770	875575	18-3075	914445	18-4024	3854095	18-1231
855326	18-5911	875580	18-3666	914556	18-3939	3854105	18-7242
855383	18-2991-1	875583	18-3076	914557	18-3938	3854106	18-7244
855383	18-2991-1-9	875584	18-3208	914816	18-4161	3854107	18-7245
855387	18-1930-2	875660	18-3037	914930	18-3879	3854116	18-7246
855507	18-6456	875660	18-3078	915236	18-4160	3854127	18-2765
855798	18-5657	875698	18-3263	925054	18-7179	3854130	18-6125Z
855845	18-5403	875736	18-3037	925055	18-7180	3854158	18-7601
855889	18-7072	875736	18-3078	925065	18-7190	3854161	18-7492
855967	18-2991-1	875741	18-8357	925091	18-7181	3854164	18-69550
855967	18-2991-1-9	875759	18-3262	925092	18-7182	3854190	18-5920
856028	18-2929	875769	18-3261	925093	18-7183	3854202	18-3869
856034	18-2949	875779	18-3654	925095	18-7122	3854215	18-29322
856037	18-2995	875781	18-3656	925256	18-7184	3854217	18-29322
856044	18-2928	875784	18-3658	925259	18-7186	3854217	18-5248
856116	18-2909	875785	18-3659	925261	18-7187	3854218	18-5413
856306	18-70704	875787	18-3660	941816	18-4215	3854252	18-3939
856364	18-3599-2	875791	18-3663	941907	18-4236	3854261	18-5406
856470	18-7099	875794	18-3662	943218	18-4238	3854269	18-0868
856471	18-7000	875795	18-3664	943414	18-2367	3854280	18-7330
856472	18-7000	875796	18-3665	946242	18-2046	3854286	18-3046
856474	18-3876	875805	18-6005	949656	18-7154	3854286	18-3060
856609	18-3577-2	875808	18-3080	950813	18-15410	3854299	18-3879
856883	18-1931-1	875815	18-6009	950818	18-15460	3854311	18-5408
856891	18-1935-1	875815	18-6009A	951924	18-4241	3854331	18-5362
856894	18-1932	875821	18-6010	952141	18-15500	3854406	18-0410
857037	18-1936	875821	18-6010A	955974	18-7193	3854512	18-7703
858201	18-7858	875821	18-6106	955983	18-7188	3854527	18-7702
858459	18-35444	875822	18-2775	955989	18-7149	3854539	18-2454
858467	18-3175	875826	18-2744	955995	18-7192	3854548	18-5354
858488	18-7907	875827	18-2755	956000	18-7194	3854549	18-5405
859155	18-3843	875828	18-2757	958303	18-15325	3854620	18-7326
859428	18-35442	875847	18-2774	958310	18-15390	3854751	18-5913-1
859647	18-3867	875848	18-2758	958311	18-15405	3854905	18-7679
861250	18-0307	876037	18-5704	958314	18-15435	3854942	18-0311
861251	18-0310	876038	18-6271	958320	18-15495	3854956	18-0518
861476	18-8701	876039	18-5705	958357	18-15415	3855017	18-7241
861477	18-8126	876040	18-6266	958498	18-4046	3855104	18-7792
862293	18-7888	876069	18-57702	958838	18-2043	3855182	18-7689
870670	18-6271	876097	18-3656	958860	18-2047	3855194	18-7704
870690	18-5357	876120	18-3287	966382	18-15435	3855275	18-2598
870998	18-6958	876185	18-7890	966857	18-4046	3855276	18-7268
872022	18-6846	876267	18-8358	975672	18-7181	3855296	18-7757
872066	18-7647	876268	18-8359	984513	18-6028	3855411	18-6028
872235	18-5939	876278	18-4204	985316	18-1401	3855412	18-6102
872241	18-5906	876279	18-2366	985727	18-21753	3855610	18-6125M
872272	18-6268	876294	18-2744	986280	18-6779	3855958	18-7330
872300	18-6266	876300	18-2998	988037	18-7330	3855991	18-3577-2
872449	18-6838	876302	18-2813	1141679	18-9680-2	3856003	18-5919
872449	18-6881	876303	18-3870	1141681	18-9680-5	3856004	18-5913-1
872757	18-6846	876305	18-3662	1141682	18-9680-7	3856127	18-1400
872793	18-6124Z	876306	18-2814	1218630	18-4472	3856138	18-1237
872926	18-5943	876314	18-0252	1218674	18-1478	3856393	18-7641
873051	18-6838	876342	18-2983	1243632	18-5357	3856884	18-33800
873178	18-6004	876356	18-2980	1266286	18-7878-1	3856961	18-3677
873178	18-6004A	876358	18-2982	1266796	18-2930	3857265	18-6274
873178	18-6105	876359	18-2817	1306169	18-5305	3857487	18-7700
873179	18-6000	876376	18-4342	1306630	18-4031	3857489	18-6806
873179	18-6000A	876380	18-4341	1317466	18-2933	3857532	18-5899
873179	18-6104	876384	18-0489	1336255	18-2530	3857561	18-6261
873228	18-2432	876433	18-2818	1357199	18-6839	3857650	18-7330
873229	18-2433	876631	18-2758	1378645	18-2968	3857656	18-1848
873395	18-6123Z	876633	18-2757	1378646	18-2970	3857723	18-1986-1
873635	18-6846	877066	18-3275	1378864	18-2926	3857747	18-6275
873757	18-6846	877349	18-3658	1378870	18-2972	3857813	18-6265
873770	18-5939	881681	18-6872	1378879	18-2930	3857985	18-7331
873771	18-6846	881682	18-6958	3853945	18-6779	3857986	18-7326
875192	18-2625	897367	18-4214	3853960	18-3937	3858061	18-9410-7
875383	18-3209	897426	18-2041	3853982	18-5913-1	3858071	18-6817
875400	18-2983	897707	18-2104	3853983	18-3676	3858081	18-5700
875401	18-2980	897720	18-6792	3854001	18-5108	3858256	18-3081
		897873	18-4239	3854002	18-5443	3858261	18-7326

O.E. #	SIERRA #	O.E. #	SIERRA #	O.E. #	SIERRA #	O.E. #	SIERRA #
VOLVO cont.		1357199-7	18-6839	60X-44323-00-00	18-3520	62Y-41133-00	18-99002
3858340	18-3593	17253-6	18-3745	60X-81800-00-00	18-6832	62Y-41134-01	18-99003
3858462	18-15450	3523301-4	18-6839	60X-W0078-00	18-3522-1	62Y-43800-11-00	18-6811
3858714	18-7331	3803227-2	18-59700	60X-W0078-00-00	18-3516	62Y-43880-00-00	18-6811
3858809	18-5700	3803270-2	18-6846	61A-11181-A0-00	18-3891	62Y-46241-00-00	18-15144
3858941	18-7685	3851218-2	18-7789	61A-11181-A1-00	18-3891	62Y-W0001-20-00	18-74540
3858979	18-7706	3851218-2	18-7989	61A-11193-A1	18-99051	63D-11181-A1	18-99060
3859054	18-5811	3852374-2	18-1986-1	61A-11381-A0	18-99052	63D-11193-A0	18-99059
3859078	18-7493	3852648-9	18-3730	61A-12414-A0-00	18-0829	63D-44312-00	18-9083
3859082	18-7643	3853862-5	18-21753	61A-13411-00	18-79976	63D-44316-00-00	18-0483
3860082	18-5979	3853962-3	18-21751	61A-13621-A0	18-99053	63D-44322-00-00	18-3449
3860566	18-6275	3854194-2	18-6291	61A-13645-00	18-99054	63D-44323-00-00	18-3186
3860764	18-5913-1	3855270-9	18-1909-1	61A-13646-00	18-99055	63D-45114-A0	18-99004
3860769	18-5957	3855270-9	18-1909-1	61A-24563-00-00	18-7782	63D-45123-00	18-99005
3860879	18-6806	3856600-6	18-6261	61A-24564-00-00	18-7486	63D-W0001-00	18-99061
3861267	18-7648	3857846-4	18-2434	61A-41134-A0	18-99000	63D-W0078-01-00	18-3415
3861575	18-6804	3858437-1	18-21752-1	61A-43880-01-00	18-6782	63D-W0078-01-00	18-3434
3862014	18-5405	419763-8	18-2965	61A-43880-02-00	18-6782	63M-81800-00-00	18-6908
3862228	18-7989	463903-5	18-4246	61A-44311-00-00	18-3173-1	63M-81960-00-00	18-6857
3862281	18-3081	5003564-1	18-6839	61A-44311-01	18-3522-1	63P-12414-00-00	18-99127
3862281	18-3277	576266-8	18-8361	61A-44311-01	18-3523-1	63P-13915-00-00	18-79902
3862500	18-7513	818701-5	18-5310	61A-44311-01-00	18-3173-1	63P-14984-00	18-0712
3862567	18-3276-1	834438-4	18-1930-2	61A-44322-00-00	18-3333	63P-45987-00-00	18-73918
3862612	18-6848	834625-6	18-59700	61A-44322-02-00	18-3519	63P-46241-00-00	18-15140
3862613	18-6845	834985-4	18-7095	61A-45113-A0	18-99056	63P-81950-00	18-1522
3862613	18-6847	835908-5	18-2971-1	61A-45114-A0	18-99001	63V-11181-A2	18-99140
3862665	18-6845	841047-4	18-7641	61A-45371-00-00	18-6119A	63V-14301-00-00	18-34603
3863061	18-1909-1	841066-4	18-5903	61A-45371-00-00	18-6119Z	63V-14985-00	18-7064
3863061	18-1909-1	841293-4	18-7001	61A-45527-00-00	18-9076	63V-15713-00-00	18-51001
3863085	18-25250	841313-0	18-7641	61A-45527-00-00 +	18-9079	63V-24411-00-00	18-7390
3863130	18-7642	841378-3	18-59700	61A-45538-00-00	18-9075	63V-41133-A1	18-99006
3863193	18-6028A	841634-9	18-7200	61A-45538-00-00 +	18-9079	63V-44301-00	18-3412
3863450	18-2780-1	841836-0	18-7000	61A-81800-01-00	18-6861	63V-44301-00-00	18-3356
3863450	18-2780-1	847306-8	18-6872	61A-81840-00-00	18-56007	63V-44322-00-00	18-3444
3884950	18-5882	847308-4	18-6958	61A-81941-00-00	18-5853	63V-44323-00-00	18-3195
3884950	18-6845	849748-9	18-6955	61A-81950-01	18-1523	63V-44328-01	18-9090
3885317	18-5913-1	854525-3	18-6817	61A-W0001-01-00	18-4400	63V-44352-01-00	18-3040
3888813	18-6127A	855384-4	18-1935-1	61A-W0001-21-00	18-2799	63V-44365-10-00	18-3505
3888814	18-6127Z	855846-2	18-5303	61A-W0001-A1-00	18-4400	63V-45113-A1	18-99150
3888815	18-6127M	856039-3	18-2971-1	61A-W0001-C1-00	18-2799	63V-45315-A0	18-99063
3888816	18-6126A	873757-9	18-6846	61A-W0078-01-00	18-3395	63V-85520-00	18-5183
3888817	18-6126Z	875807-0	18-3079	61A-W0078-A2-00	18-3396-1	63V-85520-01	18-5183
3888818	18-6126M	875808-8	18-3036	61A-W0078-A3-00	18-3396-1	63V-85533-00-00	18-25604
3888821	18-2583	875811-2	18-3081	61A-W0093-00-00	18-7772	63V-85540-00-00	18-5132
3888822	18-2584	876532-3	18-8801-1	61A-W0093-01-00	18-7772	63V-85540-01-00	18-5132
3888916	18-1076	877061-2	18-3038	61B-82510-00-00	MP51030	63V-85540-02-00	18-5132
3888917	18-2726	877061-2	18-3077	61B-82510-01-00	MP51030	63V-85570-00-00	18-23602
3911020	18-4173	949658-9	18-7147-9	61B-82510-01-00	MP51032	63V-85580-01-00	18-25652
3911023	18-4164	966694-2	18-4044	61N-11603-00-00	18-3957	63V-W0001-01	18-99175
4785974	18-7926	R7044289	18-80008	61N-11635-00-00	18-4145	63V-W0001-21-00	18-74507
5001677	18-6846	R80316	18-79998	61N-11636-00-00	18-4146	63V-W0078-01	18-3412
5003564	18-6839	WESTERBEKE		61N-14392-00-00	18-7049	63V-W0078-01-00	18-3433
6209190	18-6956	21235	18-7925	61N-24560-10	18-79910	63V-W0093-00-00	18-7058
6643474	18-6271	30220	18-7910-1	61N-24563-00-00	18-7781	646-24251-02-00	18-7713
8602629	18-6953	YAMAHA		61N-44311-00-00	18-3185	646-44322-00-00	18-3328
8602710	18-6953	19-1400-10	18-6843	61N-44311-01-00	18-3185	646-44323-00-00	18-3357
8602714	18-6953	1WD-E3440-00-00	18-8700	61N-44322-01-00	18-3443	646-44352-01-00	18-3072
8676496	18-6953	2MB-E3440-00-00	18-8700	61N-44323-00	18-3194	647-14385-00-00	18-7065
8676498	18-6953	3FV-13440-00-00	18-7902	61N-45251-01-00	18-6120A	647-44366-00	18-1833
8676499	18-6953	3FV-13440-20-00	18-7902	61N-45251-01-00	18-6120Z	647-45616-02	18-3709
8692305	18-8003-1	5GH-13440-00-00	18-7911-1	61N-85570-00-00	18-5113	648-14198-A0-00	18-0775
8757166	18-8802-1	5GH-13440-20	18-8700	61N-85570-10-00	18-5113	648-14385-00-00	18-7066
8757166	18-8823-1	5GH-13440-50-00	18-8700	61N-W0078-11-00	18-3432	648-24411-00-00	18-7839
21124846	18-3557	5JW-13400-00-00	18-8700	61N-W0093-00-00	18-7737	64D-14384-01-00	18-0856-1
21148403	18-3276-1	60E-81800-00-00	18-6921	61T-11193-A1	18-99057	64D-W0093-00-00	18-7756
21213660	18-30778	60E-81950-00-00	18-1525	626-14390-90	18-7079	64E-13645-A0	18-99064
21213664	18-6944	60V-11181-00	18-99048	62L-85570-00-00	18-5129	64E-43822-00-00	18-2081
21323043	18-5467	60V-12411-00	18-3525	62T-85520-00-00	18-5147	64E-4384J-00-00	18-2082
21436799	18-0033	60V-12414-A0-00	18-60508	62T-85520-01-00	18-5147	64E-43869-00-00	18-7469
21707133	18-7514	60V-13621-A0	18-99049	62T-85533-00-00	18-5146	64E-43880-00-00	18-6783
22797780	18-3513	60V-13645-00	18-99050	62X-43880-00-00	18-6811	64E-43880-01-00	18-6783
22844837	18-8702	60V-13907-00-00	18-7343	62X-43880-00-00	18-6812	64J-41133-10	18-99008
30788490	18-9553-2	60V-24251-01-00	18-79907	62X-43880-01-00	18-6812	64X-81800-00-00	18-6862
40005011	18-9553-3	60V-43880-00-00	18-6798	62X-43880-01-00	18-6812	64X-81800-00-00	18-6906
40005012	18-9553-5	60V-46241-00-00	18-15143	62X-43880-09-00	18-6789	650-11651-04-00	18-1755
40005013	18-9553-7	60V-81800-00-00	18-6832	62Y-12414-00-00	18-6812	650-11651-04-00	18-1755K
40005014		60X-43315-A0-00	18-0406	62Y-14392-00-00	18-0835	650-24431-00	18-0849
					18-7049	650-24431-A0-00	18-0849

O.E. #	SIERRA #	O.E. #	SIERRA #	O.E. #	SIERRA #	O.E. #	SIERRA #
YAMAHA cont.		66M-W0093-01-00	18-7738	67F-W0078-00	18-3409	689-W0001-C1-00	18-2785
655-12414-A1-00	18-0232	66T-11181-A0-00	18-60522	67F-W0078-00-00	18-3451	689-W0001-C2-00	18-0023
65E-85570-00-00	18-5119	66T-11193-A0-00	18-60520	67F-W0093-00-00	18-7743	689-W0078-04-00	18-3426
65L-13645-00	18-99066	66T-14301-00-00	18-34605	67F-W4599-00-00	18-73996	689-W0078-A4-00	18-3426
65L-13646-00	18-99067	66T-15713-00-00	18-51003	67F1439A-00-00	18-7056	689-W0078-A6-00	18-3427
65L-13915-00-00	18-79901	66T-41114-A0-00	18-60532	67H-8592A-00-00	18-7655	689-W0093-02-00	18-7770
65L-14984-00	18-0715	66T-41133-A0-00	18-60529	67H-8592A-01-00	18-7655	68D-11351-A0-00	18-60518
65L-24563-00-00	18-7517	66T-44311-00	18-3413	680-85570-00-00	18-5138	68D-E1169-A0-00	18-60512
65L-24564-00-00	18-7487	66T-44323-00-00	18-3196	680-85570-02-00	18-5138	68D-E1193-A0-00	18-60519
65L-W0001-C0-00	18-74510	66T-45113-A0-00	18-60528	680-85570-09-00	18-5112	68D-E2414-A0-00	18-0754
65N-44315-A0	18-0453	66T-W0078-00	18-3413	682-11351-A0	18-99095	68D-G4311-01-00	18-43263
65N-44323-00	18-0408	66T-W0078-00-00	18-3440	682-11610-01-00	18-3976	68D-G5987-00-00	18-73891
65N-W0078-A0-00	18-4533	66T-W4599-00-00	18-73995	682-11610-11-00	18-3977	68D-WG078-00-00	18-48619
65W-11169-00	18-99068	66V-81960-00-00	18-6651	682-12414-A1-00	18-0836	68F-11181-00	18-99062
65W-11181-30-00	18-63968	670-45997-02-00	18-73914	682-41112-A1	18-99096	68F-11193-01	18-99099
65W-11351-00	18-99069	676-11181-A0-00	18-3892	682-41133-A0	18-99021	68F-11381-00	18-99100
65W-11356-00	18-99070	676-11181-A1-00	18-3892	682-44315-A0-00	18-0768	68F-13440-00	18-79971
65W-13645-00-00	18-60535	676-12414-A0-00	18-60540	682-44352-01-00	18-3074	68F-13907-00-00	18-7342
65W-14198-00-00	18-76689	676-13646-A0	18-99080	682-44365-00	18-1834	68F-13907-01-00	18-7342
65W-14457-10	18-99071	676-14984-00-00	18-0840-1	682-44366-00	18-1831	68F-13915-00-00	18-79904
65W-24251-10-00	18-7830	676-14985-01-00	18-7392	682-44367-00	18-1832	68F-24563-00	18-79980
65W-41114-00	18-99072	676-41112-A0	18-99081	682-45113-A1	18-99022	68F-24563-10-00	18-7955
65W-41114-01-00	18-60531	676-41133-A0	18-99014	682-82556-00-00	MP28860	68F-41114-00	18-99101
65W-43865-00-00	18-7470	676-44315-A1	18-99082	682-W0001-06	18-99097	68F-45113-00	18-99102
65W-43871-00-00	18-7484	676-44324-A0	18-99083	682-W0078-A1-00	18-3148	68F-46241-10-00	18-15145
65W-46241-00-00	18-15135	676-45114-A0	18-99015	682-W0078-A1-00	18-3411	68F-81800-01-00	18-6426
65W-81941-00-00	18-5819	676-45127-00	18-99084	683-45315-A0	18-99152	68F-8592A-00-00	18-7656
65W-85570-01-00	18-23205	676-45128-00	18-99085	683-W0001-C1-00	18-74501	68F-W0001-01	18-99103
65W-W0001-20	18-99073	677-14198-A1	18-99145	688-11181-02-00	18-3805	68F-W1135-00-00	18-64415
662-44352-01-00	18-3063	677-14384-01	18-99146	688-11181-A1-00	18-3805	68T-13475-00	18-99027
663-13622-00-00	18-0242	677-24411-02-00	18-7837	688-11193-01-00	18-0767	68T-24251-00-00	18-7710-1
663-13622-A0-00	18-0242	677-24471-01-00	18-7838	688-11603-A0-00	18-3969	68T-44323-00-00	18-3142
663-24410-00-00	18-7334	677-W0093-00-00	18-7059	688-11650-03-00	18-1756	68T-44352-00-00	18-8910
663-24411-00-00	18-7840	677-W0093-04-00	18-7059	688-12414-A1-00	18-0844	68T-44366-00-00	18-3176
663-44311-02	18-3408	679-44316-A0	18-99086	688-13621-A1	18-99098	68T-46241-00-00	18-15138
663-44315-A0-00	18-0292	679-45315-A0	18-99087	688-41112-A0-00	18-0847	68T-W0001-20-00	18-74544
663-44316-A0	18-99149	679-W0078-00-00	18-3397	688-41114-A0	18-99148	68T-W0078-00-00	18-3410
663-44322-00-00	18-3435	679-W0078-A0-00	18-3397	688-41133-00	18-99023	68T-W0078-00-00	18-3450
663-44323-00-00	18-3436	67C-11356-00	18-99088	688-41134-A0	18-99024	68V-11325-01-00	18-6118A
663-44324-A0-00	18-0294	67C-41114-00	18-99089	688-43880-11-00	18-6821	68V-13766-00-00	18-2083
663-44366-00	18-1828	67C-41133-00	18-99016	688-44311-01-00	18-3171	68V-13907-00-00	18-7340
663-44366-00	18-1830	67C-43880-00-00	18-6748	688-44315-A0-00	18-0239	68V-13907-01-00	18-7340
663-45123-00	18-99009	67C-43880-01-00	18-6748	688-44316-A0-00	18-0240	68V-13907-02-00	18-7340
663-45331-00-94	18-2773	67C-45113-00	18-99091	688-44352-03-00	18-3070	68V-13907-03-00	18-7340
663-81840-11-00	18-56004	67C-45123-00	18-99017	688-45113-A0	18-99151	68V-13915-00-00	18-79903
663-W0078-00-00	18-3425	67C-W0001-00	18-99092	688-45114-A1	18-99025	68V-14984-00	18-0710
663-W0078-A0-00	18-3425	67C-W0001-20	18-99093	688-45123-00	18-99026	68V-15312-00	18-99028
664-41114-A0-00	18-0250	67C-W0001-21-00	18-0020	688-45331-00-94	18-2782	68V-24502-00-00	18-79986
664-41134-A0	18-99010	67D-14301-13-00	18-34601	688-45341-00-00	18-2374	68V-24502-01-00	18-79986
664-45371-01-00	18-6096	67D-15713-00-00	18-51002	688-45341-00-00	18-23741-9	68V-24502-02	18-79986
66K-13907-00-00	18-7341	67D-24410-03-00	18-35304	688-45341-10-00	18-2374	68V-24502-20-00	18-79985
66K-13915-00-00	18-79900	67D-45113-A0-00	18-60527	688-45341-10-00	18-23741-9	68V-24502-30	18-79985
66K-14984-00	18-0711	67D-W0093-00-00	18-7736	688-45371-02-00	18-6070	68V-24563-00-00	18-7979
66K-W0001-20-00	18-74512	67F-11181-02	18-99094	688-45371-02-00	18-6111	68V-44323-00-00	18-3521
66M-11181-10-00	18-63966	67F-12411-01-00	18-3632	688-45611-00-00	18-2388	68V-45123-00-00	18-0618
66M-11351-10	18-99074	67F-14371-01	18-79972	688-45997-01-00	18-4274	68V-81800-01-00	18-6427
66M-11356-00	18-99075	67F-24251-02-00	18-7516	688-81800-12-00	18-6423	68V-W0001-20-00	18-74515
66M-11357-00-00	18-60513	67F-41133-A1	18-99018	688-81941-00-00	18-5879	68V-W0078-00	18-3523-1
66M-12411-01-00	18-3541	67F-41134-A0	18-99019	688-81950-10-00	18-5879	68V-W0078-00-00	18-3442
66M-13329-10	18-99076	67F-41138-00-00	18-0605	688-85540-16-00	18-5130	692-14590-00-00	18-7060
66M-13645-00-00	18-60534	67F-43880-00-00	18-6787	688-W0001-00-00	18-4415	692-14590-01-00	18-7060
66M-14301-00-00	18-34600	67F-44311-01	18-3409	688-W0001-20-00	18-2798	692-24410-00-00	18-7334
66M-14301-12-00	18-34600	67F-44322-00-00	18-3162	688-W0001-22-00	18-0021	692-24411-00-00	18-7391
66M-24410-10-00	18-35302	67F-44323-00-00	18-3143	688-W0001-A0-00	18-4415	692-W0078-00-00	18-3370
66M-41114-01-00	18-60530	67F-44352-00-00	18-3042	688-W0001-C0-00	18-2798	692-W0078-01-00	18-3370
66M-41133-00	18-99012	67F-45123-00	18-99020	689-11181-02-00	18-3804	692-W0078-A0-00	18-3370
66M-41138-00	18-99078	67F-45127-00-00	18-0617	689-11631-00-95	18-4138	692-W0078-A0-00	18-3371
66M-45113-00	18-99013	67F-46241-00-00	18-15131	689-15755-01-00	18-50000	695-11181-A0-00	18-3849
66M-45115-00	18-99079	67F-81800-02-00	18-6425	689-44352-02-00	18-3067	695-11181-A1-00	18-3849
66M-46241-00-00	18-15137	67F-82341-00-00	18-5217-1	689-45113-A1-00	18-0739	695-85540-12-00	18-5131
66M-81800-01-00	18-6943	67F-82341-00-00+	18-8847-1	689-81311-40-00	18-5195	695-85570-10-00	18-5112
66M-81800-02-00	18-6943	67F-82342-00-00	18-5218-1	689-81800-11	18-6410	695-W0001-01-00	18-4417
66M-85520-00-00	18-25600	67F-82342-00-00+	18-8847-1	689-81800-12	18-6410	695-W0001-02-00	18-4417
66M-85540-01-00	18-25300	67F-82343-00-00	18-5219-1	689-81800-13-00	18-6410	695-W0001-A2-00	18-4417
66M-85570-00-00	18-23601	67F-82343-00-00+	18-8847-1	689-81840-11-00	18-56002	696-W0093-02-00	18-7290
66M-85580-00-00	18-25650	67F-82344-00-00	18-5220-1	689-W0001-21-00	18-2785	697-11181-A0-00	18-3848
66M-W0093-00-00	18-7738	67F-82344-00-00	18-8847-1	689-W0001-23-00	18-0022	697-11181-A1-00	18-3848
		67F-W0001-20-00	18-74535	689-W0001-A1-00	18-3804	697-44352-00-00	18-3069

O.E. #	SIERRA #	O.E. #	SIERRA #	O.E. #	SIERRA #	O.E. #	SIERRA #
YAMAHA cont.							
697-45114-A0	18-99030	6CB-13016-00	18-0707	6E5-85570-11-00	18-5110	6G5-11181-A0-00	18-3894
697-81800-12	18-6412	6CB-13915-00	18-79978	6E5-W0001-51-00	18-2794-1	6G5-11193-A0-00	18-0779
697-85570-11-00	18-5111	6CB-14984-00	18-0716	6E5-W0001-F1-00	18-2794-1	6G5-11382-A1-00	18-0808
698-W0001-20-00	18-2787	6CB-24501-00	18-79979	6E5-W0078-01-00	18-3372	6G5-11631-00-93	18-4129
698-W0001-21-00	18-0024	6CB-44315-00-00	18-0451	6E5-W0078-A1-00	18-3373	6G5-11636-00-00	18-4133
698-W0001-C0-00	18-2787	6CB-44323-00-00	18-4572	6E5-W0093-06-00	18-7002	6G5-11642-00-93	18-4128
69G-W0001-20-00	18-0025	6CB-81800-00-00	18-6961	6E7-11181-00-00	18-3828	6G5-13645-A1-00	18-0809
69G-W0078-00	18-3475	6CB-W0078-00-00	18-3474	6E7-11181-A1-00	18-3828	6G5-14483-A1	18-99118
69J-13440-00-00	18-7906-1	6CB-W4624-00-00	18-15134	6E7-11631-00-97	18-4135	6G5-41112-A1-00	18-0812
69J-13440-01-00	18-7906-1	6CE-12411-00-00	18-3524	6E7-14227-00	18-99144	6G5-41134-A1	18-99039
69J-13907-04-00	18-7339	6CE-44311-01-00	18-3482	6E7-14385-00-00	18-7393	6G5-43864-00-00	18-7468
69J-13907-04-00	18-7345	6CE-44315-00-00	18-3458	6E7-14390-12-00	18-7073	6G5-43880-02-00	18-6760
69J-24501-00	18-79981	6CE-44323-01-00	18-3459	6E7-85570-10-00	18-5112	6G5-44323-00-00	18-3345
69J-24501-10-00	18-79905	6CE-44352-00-00	18-45617-1	6E7-85570-19-00	18-5112	6G5-45113-A0-00	18-0813
69J-24502-00	18-79982	6CE-W0078-01	18-3470	6E7-W0093-04-00	18-7769	6G5-45114-A1	18-99040
69J-41134-A0	18-99032	6CE-W0078-01+6CE-44311-01	18-3471	6E8-14380-12-00	18-7073	6G5-45251-01-00	18-6090
69J-41135-A0	18-99033	6CJ-44311-00-00	18-3485	6E9-11193-A0	18-99106	6G5-W0001-03-00	18-4404
69J-41136-A0	18-99034	6CJ-44315-00	18-0448	6E9-12414-A1	18-99142	6G5-W0001-21-00	18-2794-1
69J-41138-00-00	18-0619	6CJ-44316-00	18-0449	6E9-41114-A0	18-99107	6G5-W0001-A3-00	18-4404
69J-43880-00-00	18-6798	6CJ-44324-00	18-0450	6E9-82575-02-00	18-65450	6G5-W0001-C1-00	18-2794-1
69J-45123-00-00	18-0656	6CJ-W0078-00-00	18-3494	6E9-W0093-02-00	18-7740	6G5-W0078-01-00	18-3310
69J-46241-00-00	18-15141	6D3-81800-00-00	18-6907	6E9-W0093-03-00	18-7741	6G5-W0078-A1-00	18-3311
69J-81800-00-00	18-6833	6D8-WS24A-00-00	18-79799	6EE-G4311-00	18-4567	6G5-W0093-08-00	18-7747
69L-45371-00-00	18-6122A	6DA-12411-01-00	18-3636	6EE-G4322-00	18-4546	6G5-W4599-00-00	18-3782
69L-45371-00-00	18-6122Z	6DA-W4624-00-00	18-15142	6EE-G4323-00	18-4573	6G8-11181-00-00	18-3827
69L-81800-00-00	18-6861	6E0-24411-00-00	18-7389	6EE-G4366-00	18-1840	6G8-11181-A1-00	18-3827
69M-11181-00-00	18-60523	6E0-24471-00-00	18-7834	6EE-W0078-00-00	18-3473	6G8-11351-A0	18-99119
69M-11196-A0-00	18-60521	6E0-44352-00-00	18-3073	6EG-G4315-00	18-99157	6G8-12414-A0	18-99120
69M-12411-01-00	18-3624	6E0-44366-00-00	18-3166	6EG-G4322-00	18-4547	6G8-13440-00-00	18-7901
69M-14301-11-00	18-34604	6E0-W0001-C1-00	18-0028	6EG-G4323-00	18-4574	6G8-13646-A0	18-99121
69M-G4323-00	18-0409	6E5-11181-02-00	18-3832	6EG-G4328-00	18-9089	6G8-14198-A0	18-99122
69M-G4328-00	18-9091	6E5-11181-A1-00	18-3832	6EG-W0078-00-00	18-4532	6G8-15374-00	18-99123
69M-WG078-00-00	18-4534	6E5-11193-A0-00	18-0781	6EK-12411-00-00	18-3639	6G8-45113-A1	18-99045
69W-43880-00-00	18-6811	6E5-11381-A1-00	18-0782	6F3-W0001-04-00	18-4403	6G8-46241-00-00	18-15133
69W-81800-00	18-6861	6E5-11610-03-00	18-3934	6F3-W0001-21-00	18-2794-1	6G9-W0001-C6-00	18-74527
69W-81800-00-00	18-6942	6E5-11610-23-00	18-3936	6F3-W0001-A4-00	18-4403	6GD-G4325-00-00	18-1079
6A0-24410-00-00	18-7334	6E5-12411-02-00	18-3623	6F3-W0001-C1-00	18-2794-1	6HO-W0093-00-00	18-7742
6A0-24410-01-00	18-7334	6E5-12411-30-00	18-3540	6F5-12411-03-00	18-3625	6H1-11631-03-95	18-4097
6A0-24410-02-00	18-7334	6E5-13411-00	18-79975	6F5-24563-00-00	18-7780	6H1-11636-03-00	18-4099
6A0-24410-03-00	18-7334	6E5-13621-A1	18-99105	6F5-44352-00-00	18-3088	6H1-13411-00	18-79961
6A0-24410-04-00	18-7334	6E5-13645-A1-00	18-0823	6F5-81800-11	18-6421	6H1-43880-00-00	18-6259
6A0-24410-05-00	18-7334	6E5-14198-A1-00	18-0785	6F5-85540-21-00	18-5136	6H1-43880-02-00	18-6781
6A0-W0001-21	18-99104	6E5-14384-02-00	18-0786	6F5-85540-22-00	18-5136	6H1-45251-02-00	18-6091
6A1-W0001-22-00	18-0026	6E5-14384-03-00	18-2592	6F5-W0078-00-00	18-3398	6H1-81950-01-00	18-1524
6A1-W0001-23-00	18-0027	6E5-14385-00-00	18-7068	6F5-W0078-A0-00	18-3398	6H1-W0001-00-00	18-4405
6A1-W0078-01-00	18-3463	6E5-14385-01-00	18-7068	6FM-44323-01	18-4576	6H1-W0001-01-00	18-4405
6A1-W0078-02-00	18-3462	6E5-14385-02-00	18-7069	6FM-W0078-00-00	18-4527	6H1-W0001-A0-00	18-4405
6A1-W0093-01-00	18-7293	6E5-14546-00-00	18-7055	6FP-12411-00-00	18-3641	6H1-W0093-01-00	18-7291
6AH-44311-00-00	18-3484	6E5-24305-05	18-80415	6G1-11193-A1	18-99108	6H1-W4599-00-00	18-3781
6AH-46241-00-00	18-15136	6E5-24410-00-00	18-7349	6G1-13621-A1	18-99109	6H2-14591-00-00	18-7056
6AH-W0078-00	18-3479	6E5-24410-01-00	18-7349	6G1-13645-A1	18-99110	6H2-81960-00-00	18-6858
6AW-12411-00-00	18-3634	6E5-24410-02-00	18-7349	6G1-14198-A1	18-99111	6H3-11181-01-00	18-3831
6AW-13907-00-00	18-7344	6E5-24410-03-00	18-7349	6G1-14546-00-00	18-7054	6H3-11181-A1-00	18-3831
6AW-14984-00	18-0714	6E5-24410-04-00	18-7349	6G1-14546-01-00	18-7054	6H3-11193-A1	18-99141
6AW-24502-00-00	18-79984	6E5-24410-10-00	18-7349	6G1-14985-00-00	18-7067	6H3-11631-01-96	18-4091
6AW-24502-10	18-79984	6E5-24411-00-00	18-7843	6G1-15755-00-00	18-50001	6H3-11636-01-00	18-4093
6AW-44311-01-00	18-3483	6E5-24471-00-00	18-7842	6G1-15779-00-00	18-50000	6H3-12411-11-00	18-3622
6AW-44312-00-00	18-9082	6E5-41112-A1-00	18-0799	6G1-15779-00-00	18-50001	6H3-12414-A1	18-99124
6AW-44315-00	18-0452	6E5-41134-A0	18-99037	6G1-24305-04	18-80414	6H3-13621-A1	18-99143
6AW-44322-00-00	18-3457	6E5-41135-A0	18-99038	6G1-24305-05-00	18-80414	6H3-13622-00	18-99125
6AW-44323-00	18-0421	6E5-43880-01-00	18-6821	6G1-24411-00-00	18-7388	6H3-14198-01	18-99126
6AW-44336-00	18-3028	6E5-43880-02-00	18-6821	6G1-24431-01	18-99147	6H3-14590-00-00	18-7056
6AW-44352-00-00	18-8925	6E5-44311-00-00	18-3170	6G1-24471-00-00	18-7833	6H3-14590-01-00	18-7056
6AW-44365-00-00	18-1829	6E5-44312-00-00	18-9081	6G1-41112-A1	18-99112	6H3-41112-A0	18-99128
6AW-W0078-00-00	18-3477	6E5-44315-A0-00	18-0244	6G1-41114-A0	18-99113	6H3-41114-A0	18-99129
6AW-W4624-00-00	18-15139	6E5-44323-00-00	18-3344	6G1-41133-A0	18-99114	6H3-44311-00	18-3466
6BG-13915-00	18-79970	6E5-44352-01-00	18-3071	6G1-44315-A0-00	18-0753	6H3-44315-A0-00	18-0756-1
6BG-W0078-00-00	18-3490	6E5-44365-00-00	18-1835	6G1-44322-00-00	18-3456	6H3-44324-A0-00	18-0757
6BX-G4315-01-00	18-60541	6E5-45371-01-00	18-6097	6G1-44352-00-00	18-3066	6H3-44352-00-00	18-3069
6C5-13915-00	18-79973	6E5-45611-01-00	18-2385	6G1-45113-A1	18-99115	6H3-45113-A0	18-99130
6C5-14984-00	18-0717	6E5-81800-11-00	18-6413	6G1-45315-A0	18-99116	6H3-45114-A1	18-99046
6C5-24251-00	18-79983	6E5-81800-12-00	18-6413	6G1-81941-10-00	18-5821	6H3-45123-00	18-99047
6C5-43880-00-00	18-6836	6E5-81840-10-00	18-56005	6G1-W0001-A2	18-99117	6H3-81800-10	18-6411
6C5-43880-01-00	18-6836	6E5-81941-10-00	18-5853	6G1-W0001-C1-00	18-0029	6H3-81800-11-00	18-6411
6C5-46241-00-00	18-15130	6E5-81941-11-00	18-5853	6G1-W0078-01-00	18-3460	6H3-85510-A1	18-5746
6CB-12411-10-00	18-3637	6E5-85540-10-00	18-5135	6G1-W0078-A1-00	18-3460	6H3-W0001-21-00	18-2788
		6E5-85540-11-00	18-5135	6G1-W0093-00-00	18-7765	6H3-W0001-22-00	18-74504
		6E5-85540-12-00	18-5135	6G5-11181-00-00	18-3894	6H3-W0001-A0-00	18-4427

O.E. #	SIERRA #	O.E. #	SIERRA #	O.E. #	SIERRA #	O.E. #	SIERRA #
YAMAHA cont.							
6H3-W0001-C1-00	18-2788	6L2-44328-00	18-9092	90280-04M05-00	18-3302	97595-06540	18-8407
6H3-W0078-00-00	18-3428-1	6L2-44352-00-00	18-3065	90340-08002-00	18-2371	99999-03249-00	18-6412
6H3-W0078-00-00	18-3461	6L2-44367-00	18-1836	90340-08002-00	18-23711-9	ABA-FBARB-90-DG	18-8040
6H3-W0078-01	18-3466	6L2-44367-10	18-1837	90340-08M04-00	18-2371	ABA-FLINE-BA-RB	18-8055
6H3-W0078-01-00	18-3465	6L2-45315-A0	18-99138	90340-08M04-00	18-23711-9	ABB-FUELF-IL-TR	18-7845
6H3-W0078-02-00	18-3465	6L2-45987-01-00	18-73979	90340-14M06-00	18-2456	ABB-FUELF-IL-TR	18-7945
6H3-W0078-02-00	18-3466	6L2-81800-20-00	18-6420	904-30142-28-00	18-0755	ABB-SPRTR-HD-SS	18-7777-1
6H3-W0078-A0-00	18-3428-1	6L2-W0001-01-00	18-4422	90430-08020-00	18-4698	LUB-20W40-FC-12	18-9450-2
6H3-W0078-A0-00	18-3461	6L2-W0001-02-00	18-4422	90430-08020-00	18-46981-9	LUB-2STRK-M1-4	18-9530-3
6H3-W0093-02-00	18-7766	6L2-W0001-A2-00	18-4422	90430-14115-00	18-0826	LUB-2STRK-M1-55	18-9530-7
6H4-11181-00-00	18-3830	6L2-W0001-C3-00	18-0030	90430-14228-00	18-0755	LUB-MRNLG-KT-10	18-9393
6H4-11181-A1-00	18-3830	6L2-W0078-00-00	18-3431	90430-14M09-00	18-0755	LUB-MRNMD-KT-10	18-9391
6H4-11193-A1-00	18-0815	6L2-W0093-00-00	18-7739	91401-30028-00	18-2380	LUB-MRNMR-KT-10	18-9392
6H4-11610-00-00	18-3960	6L5-24251-00	18-79977	91401-30030-00	18-2380	LUB-MRNSM-KT-10	18-9390
6H4-11610-10-00	18-3961	6L5-44322-00-00	18-3164	91402-30022-00	18-2380	MAR-10171-00-10	18-7924
6H4-11610-20-00	18-3962	6L5-44323-00-00	18-3163	91402-30022-09	18-2380	MAR-10171-30-00	18-7606
6H4-11631-00-96	18-4141	6L5-44352-00-00	18-8911	91402-30028-00	18-2380	MAR-24563-00-00	18-7919
6H4-11635-01-00	18-4142	6L5-45616-00-00	18-73892	91402-30028-09	18-2380	MAR-FLTHD-AL-12	18-7853-1
6H4-11636-00-00	18-4143	6M6-81800-10-00	18-6862	91490-25030-00	18-73893	MAR-FLTHD-SS-12	18-7777
6H4-13621-A1	18-99132	6M6-8183E00-00	18-15080	91490-30030-00	18-2380	MAR-FUELF-IL-TR	18-7866
6H4-14198-01	18-99133	6M6-81960-A0-00	18-6650	91490-30045-00	18-3748	MAR-MINIF-IL-TR	18-7865
6H4-15369-A1	18-99134	6N0-W0001-C0-00	18-0031	91490-40030-00	18-3735	MAR-MINIF-LT-AS	18-7965-1
6H4-41112-A0	18-99135	6N0-W0078-A0-00	18-3460	92900-10600-00	18-0192	MAR-SEPAR-AT-OR	18-7852-1
6H4-41114-A0-00	18-0798	6N6-W0001-03-00	18-4411	92901-10600-00	18-0192	MAR-SEPAR-AT-OR	18-7966-1
6H4-44352-02-00	18-3068	6N6-W0001-A3-00	18-4411	92902-10600-00	18-0192	MAR-SPRTR-HD-SS	18-7984-1
6H4-81800-12-00	18-6422	6N6-W0078-00-00	18-3312	92903-10600-00	18-0192	N26-13440-00-00	18-7954
6H4-W0001-01-00	18-4407	6N6-W0078-01-00	18-3313-1	92990-06600-00	18-0191	N26-13440-02-00	18-7954
6H4-W0001-02-00	18-4419	6N6-W0093-02-00	18-7744	92990-10600-00	18-0192	YB-6AW04-1	18-9133-9
6H4-W0001-03-00	18-4409	6N7-81800-10-00	18-6415	92995-10600-00	18-0192	YB-6AW04-3	18-9146-9
6H4-W0001-04-00	18-4409	6N7-81840-00-00	18-56006	93101-20M07-00	18-0554	YB-6AW04-A	18-9145
6H4-W0001-20-00	18-2792	6OV-13646-00	18-99139	93101-22067-00	18-0296	YB-ACC04	18-79815
6H4-W0001-21-00	18-2792	6P2-14984-00	18-0713	93101-22M15-00	18-2079	YSC-10231-20-0C	18-7824-2
6H4-W0001-A1-00	18-4407	6P2-44323-00-00	18-3518	93101-23070-00	18-0297	YSC-10260-00-0C	18-15111
6H4-W0001-A2-00	18-4419	6P2-46241-02-00	18-15132	93101-25M03-00	18-0587	YSC-10260-10-0C	18-15110
6H4-W0078-00	18-3408	6P2-W0078-00-00	18-3515	93101-28M16-00	18-0265	YSC-12190-00-AC	18-2909
6H4-W0078-00-00	18-3429	6P2-WS245-00-00	18-7518	93101-30M17-00	18-0266	YSC-13080-00-0C	18-0164
6H4-W0078-A0	18-3408	6P3-24564-00-00	18-7488	93102-23096-00	18-0570	YSC-13231-20-0C	18-7824-2
6H4-W0078-A0-00	18-3429	6P3-WS24A-00-00	18-79809	93102-25M28-00	18-0588	YSC-13260-60-0C	18-15106
6H4-W0093-01-00	18-7767	6R3-85570-01-00	18-5128	93102-35M13-00	18-2085	YSC-14231-20-0C	18-7876-1
6H4-W0093-03-00	18-7768	6R3-W0001-03-00	18-4412	93102-40M36-00	18-2087	YSC-16231-20-0C	18-7875
6H4-W4599-00-00	18-73990	6R3-W0001-A3-00	18-4412	93104-22M07-00	18-2091	YSC-22260-00-0C	18-15109
6H5-43880-02-00	18-6788	6R5-11603-00	18-39320	93106-09014-00	18-0267	YSG-10108-43-8G	18-0876
6J4-81800-01-00	18-6421	6R5-11631-11-93	18-4081	93210-05001	18-71330	YSG-10108-44-5G	18-0874
6J8-11181-00-00	18-3829	6R5-11635-11-00	18-4083	93210-16716-00	18-7511-9	YSG-10114-14-1G	18-0889
6J8-11181-A1-00	18-3829	6R5-11636-11-00	18-4085	93210-19123-00	18-7463	YSG-14090-90-8G	18-0905
6J8-12414-A0-00	18-0829	6R5-11642-11-93	18-4080	93210-24M79	18-76694	YSG-14096-15-6G	18-0887
6J8-13411-00	18-79974	6R5-11645-11-00	18-4082	93210-27ME3-00	18-76691	YSG-37545-87-G0	18-0891
6J8-14546-00-00	18-7055	6R5-11646-11-00	18-4084	93210-31MJS-00	18-76693	YSG-38600-39-G0	18-0903
6J8-24471-00-00	18-7841	6R5-11650-10-00	18-4157	93210-32738-00	18-7432		
6J8-81960-00-00	18-17301	6R6-W0001-01-00	18-4413	93210-33M85-00	18-7119	YANMAR	
6J8-W0001-21-00	18-2789	6S5-81800-00-00	18-6909	93210-37M67-00	18-7483	104211-42070	18-3079
6J8-W0001-C2-00	18-2789	6Y1-24305-04	18-80413	93210-41042-00	18-0298	104211-42071	18-8952
6J8-W0078-A1-00	18-3430	6Y2-24305-05	18-80415	93210-44704	18-71331	104211-49160	18-56601
6J9-45371-01-00	18-6035	6YL-24306-60-00	18-8017EP-2	93210-45161	18-71332	104211-77010	18-6930
6J9-45371-01-00	18-6112	6YL-24306-60-00	18-8017S-1	93210-46044-00	18-7436	104211-77011	18-6930
6K1-45371-00-00	18-6034	703-82510-12-00	MP51020	93210-46M16-00	18-76690	104500-55710	18-79960
6K1-45371-02-00	18-6121A	703-82510-12-00	MP51022	93210-49046	18-71333	114361-77011	18-6936
6K1-45371-02-00	18-6121Z	703-82510-43-00	MP51040	93210-49046	18-71333	114362-77010	18-6936
6K1-82510-06-00	MP51050	703-82510-43-00	MP51042	93210-54M54-00	18-7439-9	114362-77011	18-6936
6K1-82510-06-00	MP51052	90105-10M00-00	18-6246	93210-59MG7	18-71334	114362-77011	18-6936
6K5-11601-02-00	18-3963	90119-08M03-00	18-2606	93210-66M98-00	18-0299	114399-77010	18-6936
6K5-11636-03-00	18-4096	90119-08M15-00	18-8400-9	93210-74M35-00	18-7442	119209-77010	18-6931
6K7-13645-A1-00	18-0807-1	90119-08M33	18-0260	93210-75M51-00	18-76692	119225-77010	18-6935
6K7-13686-A1	18-99136	90119-08M87-00	18-2605	93210-86M38-00	18-7485	119225-77011	18-6935
6K7-W0093-09-00	18-7759	90171-10M01	18-3773	93210-94003-00	18-7471	119226-77011	18-6935
6K8-81960-A0-00	18-6652	90171-14056-00	18-3792	93210-97M55-00	18-0275	119350-35150	18-7910-1
6L2-11181-A1-00	18-3847	90171-14056-00	18-73907	93211-04384-00	18-7444	119350-35151	18-7910-1
6L2-11181-A2-00	18-3847	90171-16011-00	18-3732	93310-32337-00	18-1410	119573-77200	18-6927
6L2-14384-00-00	18-0765	90201-08M54-00	18-73978	93310-620V5-00	18-1411	119573-77200	18-6929
6L2-14385-00-00	18-7063	90201-22M01	18-9078	93310-730V8-00	18-4077	119573-77201	18-6927
6L2-14392-00-00	18-7049	90201-22M01	18-9078	93310-836V2-00	18-4078	119573-77201	18-6929
6L2-41112-A1-00	18-0743	90201-22M01	18-9079	93604-10M03-00	18-43717	119574-42550	18-45714
6L2-41114-A1-00	18-0744	90206-22M19	18-9077	93604-18080-00	18-43716	119574-42552	18-45714
6L2-41133-A2	18-99137	90206-22M19+	18-9079	95307-16900-00	18-3732	119773-42600-00	18-3306
6L2-44311-01-00	18-3486	90280-03003-00	18-3305	97080-06045	18-0261	119773-77010	18-6938
6L2-44322-00	18-4548	90280-03024-00	18-3305	97080-08045-00	18-0256	119773-77200	18-6849
		90280-03M03-00	18-3297	97095-06040-00	18-2607	119836-77200	18-6926
		90280-04M00-00	18-3300	97095-08045-00	18-0256	119836-77200-2	18-6926
		90280-04M04-00	18-3301	97595-06535	18-8406	119836-77200-3	18-6926

O.E. #	SIERRA #	O.E. #	SIERRA #	O.E. #	SIERRA #	O.E. #	SIERRA #
YANMAR cont.							
121120-77010	18-6931						
121120-77011	18-6931						
121120-77012	18-6931						
121254-77010	18-6939						
121254-77011	18-6939						
121254-77012	18-6939						
121254-77019	18-6939						
121370-77010	18-6932						
123500-77010	18-6934						
124085-35113	18-7917						
124223-42092	18-8950						
124450-35100	18-7910-1						
124450-35110	18-7917						
124520-77010	18-6931						
124520-77011	18-6931						
124550-35110	18-7917						
124610-77010	18-6934						
124610-77019	18-6934						
127610-42200	18-3077						
128170-01331	18-55600						
128170-11310	18-56000						
128170-42090	18-56602						
128170-77010	18-6937						
128170-77010D	18-6937						
128170-77200	18-6928						
128170-77201	18-6928						
128170-77202	18-6928						
128171-01911	18-55601						
128171-12540	18-57704						
128176-42071	18-8951						
128270-12540	18-57703						
128270-77200	18-6925						
128271-01911	18-55602						
128374-01911	18-55603						
129242-77010	18-6932						
129429-77010	18-6939						
129429-77011	18-6939						
129470-77200	18-6927						
129470-77200	18-6970						
129573-77010	18-6880						
129612-77230	18-6926						
129698-77010	18-6932						
171008-77010	18-6880						
171056-35110	18-7917						
171056-35111	18-7917						
192470-42530	18-3277						
192470-42532	18-3277						
27210-200200	18-6200						
27210-200300	18-6201						
424610-77010	18-6934						
728170-92600	18-55500						
728171-92601	18-55501						
728271-92605	18-55502						
8M0095471	18-55510						
ZENITH							
K-2035	18-7732						
K-2036	18-7732						

ÍNDICE REFERENCIAS / NÚMERO DE PÁGINA

Código	Descripción	Páginas	Código	Descripción	Páginas
009374	ÁNODO	267	188076	CONECTOR MANGUERA	374
009469	ÁNODO	267	188077	CONECTOR DEPÓSITO	375
025492	ÁNODO	267	188078	CONECTOR MACHO	375
112301	CONECTOR MACHO	373	188079	CONECTOR HEMBRA	375
112307	CONECTOR DEPÓSITO	373	188085	CONECTOR MANGUERA	374
112308	CONECTOR MACHO	373	188089	CONECTOR MOTOR	375
112309	CONECTOR HEMBRA	373	188090	CONECTOR DEPÓSITO	375
112310	CONECTOR HEMBRA	373	188092	CONECTOR MANGUERA	374
112311	CONECTOR DOBLE	373	508516	FILTROS SEPARADORES DE AGUA	376
112312	CONECTOR HEMBRA	374	508517	FILTROS SEPARADORES DE AGUA	376
112314	CONECTOR MACHO	373	508518	FILTROS SEPARADORES DE AGUA	376
112315	CONECTOR HEMBRA	373	508519	FILTROS SEPARADORES DE AGUA	376
112316	CONECTOR HEMBRA	374	1880401	CONECTOR DE COMBUSTIBLE	375
112318	CONECTOR MACHO	374	1880402	CONECTOR DE COMBUSTIBLE	375
112319	CONECTOR HEMBRA	374	1880404	CONECTOR DE COMBUSTIBLE	375
112320	CONECTOR HEMBRA	374	1880405	CONECTOR DE COMBUSTIBLE	362
112321	CONECTOR HEMBRA	374	18-31604	BOMBA AGUA MAR	306
112322	CONECTOR DEPÓSITO	374	009304 Zinc	ÁNODO	337
112325	CONECTOR HEMBRA	374	009317 ZINC	ÁNODO	266
112326	CONECTOR MACHO	373	603132 AL	ÁNODO	267
112330	CONECTOR HEMBRA	373	009318 ZINC	ÁNODO	267
112331	CONECTOR HEMBRA	373	603153 AL	ÁNODO	189
112350	BOMBA DE SUCCIÓN	369,37	009321 Zinc	ÁNODO	337
112352	BOMBA DE SUCCIÓN	369,37	603047 Al	ÁNODO	337
112357	LINEA DE COMBUSTIBLE MERCURY/YAMAHA	369	18-6242 Mag	ÁNODO	188
112359	LINEA DE COMBUSTIBLE MERCURY	369	009345 Zinc	ÁNODO	267
112360	LINEA DE COMBUSTIBLE OMC	370	009348 Zinc	ÁNODO	267
112361	KIT BOMBA COMBUSTIBLE Y MANGUERA REFORZADA	369	603085 AL	ÁNODO	337
112362	LINEA DE COMBUSTIBLE OMC	370	009349 Zinc	ÁNODO	337
112363	LINEA DE COMBUSTIBLE YAMAHA	369	603083 AL	ÁNODO	188
112370	KIT BOMBA COMBUSTIBLE Y MANGUERA	369	009353 Zinc	ÁNODO	267
112397	FILTROS SEPARADORES DE AGUA	376	009364 ZINC	ÁNODO	189
112399	KIT RACORS MANGUERA PARA FILTROS	377	603129 AL	ÁNODO	266
112400	FILTROS SEPARADORES DE AGUA	376	009365 Zinc	ÁNODO	267
112401	FILTROS COMBUSTIBLE	376	603042 Al	ÁNODO	266
112402	FILTROS SEPARADORES DE AGUA	376	18-6243 Mag	ÁNODO	267
112403	FILTROS COMBUSTIBLE	376	009366 ZINC	ÁNODO	266
112404	FILTROS COMBUSTIBLE	376	009367 ZINC	ÁNODO	267
112405	FILTROS SEPARADORES DE AGUA	376	603131 AL	ÁNODO	266
112406	FILTROS COMBUSTIBLE	376	009368 ZINC	ÁNODO	189
112407	FILTRO COMBUSTIBLE	377	009371 Zinc	ÁNODO	337
112408	SOPORTE FILTRO	377	603046 Al	ÁNODO	338
112409	VASO RECAMBIO FILTROS	377	18-6244 Mag	ÁNODO	337
112410	CARTUCHO RECAMBIO	377	009379 Zinc	ÁNODO	338
112411	KIT RACORS MANGUERA PARA FILTROS	377	009396 Zinc	ÁNODO	337
112412	FILTRO COMBUSTIBLE	377	009397 Zinc	ÁNODO	338
112414	FILTRO COMBUSTIBLE	377	009576 Zinc	ÁNODO	337
112415	FILTRO COMBUSTIBLE	377	009577 Zinc	ÁNODO	188
112422	BOMBA DE CEBADO	377	009582 Zinc	ÁNODO	337
112423	FILTRO COMBUSTIBLE	377	025300 Zinc	ÁNODO	337
112425	FILTRO COMBUSTIBLE	377	025305Zinc	ÁNODO	337
112426	FILTRO COMBUSTIBLE	377	025308 Zinc	ÁNODO	337
118306	CONECTOR HEMBRA	373	025309 Zinc	ÁNODO	266
182360	PIÑON Y JUEGO ENGANAJES MARCHA ADELANTE	175	025339 ZINC	ÁNODO	337
188004	BOMBA DE SUCCIÓN	370	603154 AL	ÁNODO	337
188020	ABRAZADERAS PAR ALINEA DE COMBUSTIBLE SIERRA	370	025425 Zinc	ÁNODO	338
188021	ABRAZADERAS PAR ALINEA DE COMBUSTIBLE SIERRA	370	025458 Zinc	ÁNODO	338
188056	CONECTOR MANGUERA	374	025459 Zinc	ÁNODO	338
188062	CONECTOR HEMBRA	375	025463 Zinc	ÁNODO	267
188063	CODO DEPÓSITO	374	025756 ZINC	ÁNODO	337
188067	CODO MANGUERA	374	603127 AL	ÁNODO	337
188071	CONECTOR MACHO	375	025840ZINC	ÁNODO	267
188075	CONECTOR MANGUERA	374	603130 AL	ÁNODO	188
			18-6102	MAGNESIO	336
			025849 Zinc	ÁNODO	
			18-6014 Al	ÁNODO	
			025851 Zinc	ÁNODO	

Código	Descripción	Páginas	Código	Descripción	Páginas
025857	Zinc ANODO	337	18-0368	KIT JUNTAS BOMBA DE CIRCULACIÓN AGUA	306
112351	KIT BOMBA COMBUSTIBLE Y MANGUERA	369	18-0376	JUEGO JUNTAS PIPETA REFRIGERACIÓN	318
112355			18-0377	JUEGO JUNTAS PIPETA REFRIGERACIÓN	318
112356	LINEA DE COMBUSTIBLE UNIVERSAL	369	18-0386	JUNTA CUERPO BOMBA DE AGUA	147
112358			18-0388	JUNTA TUBO POWER TRIM	148
112364	KIT BOMBA COMBUSTIBLE Y MANGUERA	369	18-0389	JUNTA INTERCAMBIADOR	145
112365			18-0398	JUNTA TERMOSTATO	144,248,329
118-0311	JUNTA TAPA VÁLVULA	330	18-0398-9		
118-0410	JUEGO JUNTAS COLECTOR ADMISIÓN	142	18-0401	JUNTA COLECTOR ESCAPE	248
118-2462	KIT PASADOR CILINDRO TRIM	185	18-0403	KIT JUNTAS DE ADMISIÓN	138
118-6457	POLEA PLASTICO	82	18-0404	KIT JUNTA DE ADMISIÓN	138
18-0032	DIESEL FILTRO ACEITE	345	18-0405	JUNTA CARTER	141
18-0033	DIESEL FILTRO ACEITE	345	18-0405	JUNTA CARTER	245,33
18-0034	DIESEL FILTRO ACEITE	345	18-0407	JUEGO JUNTAS CARTER	142,245
18-0035	FILTRO ACEITE DIESEL, FLUJO COMPLETO	322,345	18-0410	JUEGO JUNTAS COLECTOR ADMISIÓN	245,327
18-0036	FILTRO ACEITE DIESEL	322,345	18-0411	JUEGO JUNTAS CARTER	142,245
18-0104	JUNTA CODO ESCAPE	248	18-0418	JUNTA COLECTOR ESCAPE	123, 145, 249, 329, 316
18-0104-9					
18-0111	JUNTA CODO ESCAPE	145	18-0418	JUNTA COLECTOR ESCAPE	316
18-0113-1	JUNTA CODO ESCAPE	145	18-0422	JUNTA TAPA DISTRIBUIDOR	144
18-0114	JUNTA COLECTOR	239,248	18-0430	JUNTA CODO ESCAPE	248
18-0146	JUEGO DE JUNTAS	316	18-0431	JUNTA COLECTOR ADMISIÓN	248
18-0147	JUNTA BOMBA AGUA	147,249,331	18-0434	JUNTA MONTAJE CARBURADOR	247
18-0153	JUEGO JUNTAS CARTER	141,245	18-0435	JUNTA MONTAJE CARBURADOR	247
18-0163	JUEGO JUNTAS PIPETA REFRIGERACIÓN	318	18-0440	JUNTA	249
18-0164	JUNTA ALOJAMIENTO TAPA TERMOSTATO	247,329	18-0440-9		
18-0166			CASQUILLO	250	18-0463
18-0166-9					
18-0183-1	JUNTA COLECTOR ESCAPE	123, 145, 239, 249,329	18-0464	JUNTA TAPA VÁLVULA	146,249
18-0184	ARO DE GOMA	334	18-0464-9		
18-0185	RETÉN ACEITE	147	18-0465	JUEGO JUNTAS COLECTOR ADMISIÓN	140
18-0185-9					
18-0188	ARANDELA	251	18-0465	JUEGO JUNTAS COLECTOR ADMISIÓN	245
18-0188-9					
18-0190	JUNTA	250	18-0466	JUEGO JUNTAS CARTER	141,245
18-0195	ARANELA EMPUJE	261	18-0467	JUNTA MONTAJE CARBURADOR	144
18-0198	ARANDELA DE EMPUJE	261	18-0468	JUNTA TAPA DISTRIBUCIÓN	146,250,331
18-0203	ARANDELA ALOJAMIENTO TRANSOM	149	18-0476-1	JUNTA CODO	124,239,316
18-0203-9					
18-0252	JUEGO JUNTAS CONVERSIÓN	326	18-0487	JUEGO JUNTAS ADMISIÓN	142
18-0307	JUNTA CARTER	330	18-0488	JUEGO JUNTAS ADMISIÓN	142
18-0310	JUNTA CARTER	330	18-0489	JUEGO JUNTAS CONVERSIÓN	326
18-0311	JUNTA TAPA VÁLVULA	146,249	18-0498	JUNTA CULATA	327
18-0316	ARANDELA	149	18-0518	RETÉN VÁLVULA	137,251,325
18-0322	JUNTA	148,250,332	18-0528	RETENES CIGÜEÑAL 2 PIEZAS	137, 244, 325
18-0322-9					
18-0322	JUNTA PORTA RETÉN	148	18-1211	JUNTA ADAPTOR ALOJAMIENTO INTERMEDIO	249
18-0322-9					
18-0327	JUNTA BOMBA AGUA	147,249,330	18-0549	TAPÓN	335
18-0328	JUNTA TAPA VARILLA EMPUJE	146	18-0550	TAPA TAPÓN	251
180328-9					
18-0329	JUNTA TAPA VARILLA EMPUJE	147	18-0577	ASIENTO RETÉN	169
18-0329	JUNTA VARILLA EMPUJE	250	18-0590	JUEGO JUNTAS PIPETA REFRIGERACIÓN	318
18-03353	JUNTA MONTAJE CARBURADOR	143	18-0603	KIT JUNTAS COLECTOR ESCAPE	124, 138, 240
18-0337	JUEGO DE JUNTAS	316	18-0604	KIT JUNTAS COLECTOR ESCAPE	124, 138, 240
18-0340	JUEGO JUNTAS CARTER	141	18-0606	JUEGO JUNTAS PIPETA REFRIGERACIÓN	318
18-0342	JUNTA BASE POWER TRIM	148	18-0647	VARILLA DE CAMBIO	264
18-0346	JUNTA TAPA VÁLVULA	146	18-0648	JUEGO JUNTAS PIPETA REFRIGERACIÓN	318
18-0346					
18-0347	JUNTA TAPA VÁLVULA	146,249,330	18-0652	TERMINAL VARILLA DE CAMBIO	264
18-0348	JUEGO JUNTAS CARTER	141,245	18-0653	TORNILLO VARILLA DE CAMBIO	264
18-0352	JUNTA TAPA VÁLVULA	146,249,330	18-0654	TUERCA VARILLA CAMBIO	264
18-0353	JUNTA MONTAJE CARBURADOR	123	18-0655	VARILLA DE CAMBIO	264
18-0354	JUNTA MONTAJE CARBURADOR	143	18-0664	JUNTA TAPA VÁLVULA	146,249, 330
18-0356	JUNTA MONTAJE CARBURADOR	143	18-0667	JUNTA TAPA CONECTOR	144
18-0357	JUNTA MONTAJE CARBURADOR	143	18-0667-9		
18-0360	JUNTA MONTAJE CARBURADOR	144	18-0672	JUNTA CODO ESCAPE	124,145
18-0365	JUNTA INTERCAMBIADOR	145	18-0672-9		
			18-0673	JUNTA CODO ESCAPE	248
			18-0673-9		
			18-0680	JUNTA COLECTOR ESCAPE	145, 249, 317, 329
			18-0681	ARANDELA	149
			18-0681-9		
			18-0685	JUNTA TAPA VÁLVULA	143
			18-0720	JUNTAS (CERRADO)	125

Código	Descripción	Páginas	Código	Descripción	Páginas
18-0721	JUNTAS (ABIERTO)	125	18-1158	COJINETE AGUJA	179
18-0722	JUNTAS	125	18-1158	COJINETE	260
18-0868	JUEGO JUNTAS COLECTOR ADMISIÓN	142, 245, 327	18-1160	KIT COJINETES	180
18-0874	JUNTA DISTRIBUIDOR	144, 247, 332	18-1161	COJINETE RODILLOS	179
18-0874-9			18-1161	COJINETE	260
18-0876	JUNTA BOMBA COMBUSTIBLE	143, 247, 329	18-1162	COJINETE RODILLOS	179
18-0880	JUNTYA TAPA CAMBIO	250	18-1163	COJINETE RODILLOS	179
18-0880-9			18-1164	COJINETE RODILLOS	179
18-0881-1	JUNTA CODO ESCAPE	124, 145,	18-1165	COJINETE RODILLOS	179
18-0885-1	JUNTA CODO ESCAPE	124, 145	18-1170	COJINETE PIÑÓN INFERIOR	260
18-0885-9			18-1171	COJINETE TRANSMISIÓN	260
18-0887	JUNTA TAPA DISTRIBUCIÓN	146, 250, 331	18-1172	COJINETE	260
18-0887-9			18-1173	COJINETE RODILLOS	179
18-0889	JUNTA BOMBA COMBUSTIBLE	143,329	18-1179	COJINETE RODILLOS	179
18-0889-9			18-1182	KIT COJINETE RODILLOS	179
18-0891	JUNTA MONTAJE BOMBA DE AGUA	147, 250, 330	18-1193	COJINETE RODILLOS	179
18-0891-9			18-1197	COJINETE	179
18-0892	MANGUITO DEFLECTOR	249	18-1204-1	JUNTA COLECTOR ESCAPE	124, 146, 249,
18-0893	JUNTA TRASERA BOMBA DE AGUA	147, 250, 331	18-1204-1-9		
18-0893-9			18-1210	JUNTA TAPA LATERAL	124, 145, 147,
18-0894	JUNTA TAPA AGUA	147	18-1210-9		
18-0894-9			18-1213	RETÉN CIGÜEÑAL	325
18-0897	JUNTA CODO ESCAPE	145	18-1230		
18-0897 (Restrictor)	JUNTA CODO	124	18-1213	RETENES TAPA DISTRIBUCIÓN	244
18-0898	JUNTA BOMBA ACEITE	148	18-1233		
18-0903	JUNTA BOMBA AGUA	147, 249, 330	18-1230	RETENES TAPA DISTRIBUCIÓN	137
18-0905	JUNTA TAPÓN DRENAJE ACEITE	148	18-1213		
18-0905-9			18-1233		
18-0907	JUEGO JUNTAS DRENAJE ACEITE	318	18-0578		
18-0911	JUNTA BOMBA AGUA	249	18-1231	JUNTA ADMISIÓN	141, 245, 329
18-0916	JUNTA BOMBA AGUA	147	18-1232	JUNTA CARTER	141, 245, 330
18-0923	RETÉN GOMA	251	18-1234	RETENES CIGÜEÑAL UNA PIEZA	244, 325
18-0923-9			18-0519		
18-0928-1	JUNTA COLECTOR	145	18-1234	RETENES CIGÜEÑAL	137
18-0928-9			18-0519		
18-0929	JUNTA TERMOSTATO	247, 329	18-0864		
18-0929-9			18-1236	TORNILLO DRENAJE	251
18-0937	JUNTA MONTAJE CARBURADOR	247	18-1237	JUNTA CARTER	141, 245, 330
18-0937-9			18-1238	JUEGO JUNTAS ADMISIÓN	142, 245, 327
18-0939	JUNTA	250	18-1239	JUNTA CARTER	141, 245, 330
18-0939-9			18-1240	JUNTA TAPA PARTE SUPERIOR	147
18-0943-2	JUNTA CODO ESCAPE	239, 248, 332	18-1254	JUEGO JUNTAS CULATA VORTEC	140
18-0943-2-9			18-1273	JUEGO JUNTA CULATA	367
18-0947	JUNTA	249	18-1343	COJINETE RETENEDOR	264
18-0947-9			18-1350	COJINETE	260
18-0948	JUNTA DISTRIBUIDOR	144	18-1351	COJINETE	260
18-0948-9			18-1356	COJINETE PIÑÓN	178
18-0950	JUNTA IMPULSOR ALOJAMIENTO	148	18-1357	COJINETE ENGRANARE INVERSO	260
18-0954	JUNTA CODO ESCAPE	145	18-1358	COJINETE ENGRANARE REVERSO	260
18-0956-1	JUNTA COLECTOR ESCAPE	146, 248	18-1365	COJINETE EMPUJE	260
18-0976	JUNTA TAPA DISTRIBUCIÓN	146	18-1366	COJINETE EMPUJE	260
18-0976-9			18-1370	COJINETE EMPUJE ENGRANAJE AVANTE	260
18-0980	JUNTA TAPA DISTRIBUCIÓN	146, 250	18-1371	COJINETE EMPUJE AVANTE	260
18-0994	JUNTA MONTAJE CARBURADOR	144	18-1400	LEVA HIDRÁULICA	130, 243, 324
18-0994-9			18-1402	LEVA HIDRÁULICA	130, 243, 324
18-1074	FUELLE ESCAPE	259, 333	18-1462	JUNTA MONTAJE CARBURADOR	144
18-1076	FUELLE	339	18-1476	KIT ARBOL DE LEVAS	321
18-1099	ALOJAMIENTO COJINETE	264	18-1477	KIT ARBOL DE LEVAS	321
18-1117	COJINETE PIÑÓN	178, 260	18-1478	ARBOL LEVAS	321
18-1120	COJINETE PIÑÓN	178	18-1479	ARBOL LEVAS	321
18-1126	COJINETE RODILLOS	179	18-1500	REJILLA ADMISIÓN	264
18-1127	COJINETE RODILLOS	179	18-1501	BOLA RETENCIÓN	261, 335
18-1129	COJINETE EJE TRANSMISIÓN SUPERIOR	179	18-1508	RETÉN TERMOSTATO	89
18-1142	COJINETE PIÑÓN SUPERIOR	178	18-15501	DISYUNTOR	56
18-1143	COJINETE RODILLOS	179	18-1600	KIT SUPERIOR ENGRANAJE	262
18-1150	COJINETE RODILLOS	179	18-1601	KIT SUPERIOR ENGRANAJE	262
18-1153	COJINETE A BOLAS	179	18-1602	KIT SUPERIOR ENGRANAJE	262
18-1154	COJINETE A BOLAS	260	18-1701	EJE INFERIOR TRANSMISIÓN	261
18-1155	COJINETE A BOLAS	180	18-1702	RODILLO DIABLO	263
18-1156	COJINETE RODILLOS	179			
18-1157	COJINETE AGUJA	179			

Código	Descripción	Páginas	Código	Descripción	Páginas
18-1703	RODILLO DIABLO	263	18-1971		
18-1705	TORNILLO	168	18-1971S	CODO	120
18-1706	TORNILLO	168	18-1972*	CODO	120
18-1710	ARO BRIDA INFERIOR	171	18-1973*	CODO	120
18-1711	CRUCETA CARDAN	167	18-1974-1*	CODO	121
18-1714	PASADOR	264	18-1975		
18-1727	SILENTBLOCK	322	18-1975S	CODO	121
18-1728	ARO BRIDA INFERIOR	171	18-1976		
18-1732	RETENEDOR EJE TRANSMICIÓN	261	18-1976S	CODO	121
18-1740-1	JUNTA CUERPO ACELERADOR	144	18-1977-1	TERMOSTATO ALOJAMIENTO	89
18-1750	COJINETE COMPLETO ALOJAMIENTO	260	18-1978	CODO	120
18-1842			18-1985	ESPACIADOR COLECTOR	121
18-1842S	COLECTOR ESCAPE	120	18-1986 HGE		
18-1843			18-1986S	COLECTOR ESCAPE	237, 312
18-1843S	COLECTOR ESCAPE	120	18-1989	TERMOSTATO ALOJAMIENTO	89, 362
18-1845			18-1989K	KIT SERVICIO TERMOSTATO	89, 362
18-1845S	CODO ESCAPE	121	18-1990	JUNTA TAPA ESCAPE	121
18-1848S-SIERRA			18-1991	ADAPTADOR CODO ESCAPE	120, 238, 313
18-1848-HGE	COLECTOR	312	18-1992-1	ADAPTOR ESCAPE	120, 238, 313
18-1876	CODO	238	18-1993	TERMOSTATO ALOJAMIENTO	89
18-1898	COLECTOR	118, 237, 312	18-1994	TERMOSTATO ALOJAMIENTO	89
18-1901	COLECTOR	237	18-1995	TAPA COLECTOR	122
18-1902	COLECTOR	237	18-1997-1	COLECTOR ESCAPE	118
18-1903	COLECTOR	237	18-1997S	COLECTOR ESCAPE	237
18-1904	COLECTOR	237	18-1997S-SIERRA	COLECTOR	312
18-1905	CODO	120	18-1998 HGE		
18-1906	ESPACIADOR ESCAPE	121	18-1998S	COLECTOR ESCAPE	118, 237
18-1907HGE			18-1999HGE		
18-1907S	CODO ESCAPE	121, 238, 313	18-1999S	COLECTOR CODO	120, 238, 313
18-19081			18-2094	RETÉN ACEITE	148
18-19081S	ESPACIADOR CODO COLECTOR	121	18-2097	CRUCETA CARDAN	167
18-1908K	KIT ESP. COLECTOR/CODO	121	18-2100	RODAMIENTO CARDAN	168, 254, 334
18-1909S			18-21001	COJINETE	167
18-1909-HGE	CODO ESCAPE	238, 313	18-21005	RODAMIENTO	168
18-1910	KIT TERMOSTATO ALOJAMIENTO	89	18-21005K	KIT RODAMIENTO Y RETÉN	168
18-1921	CODO COLECTOR	238	18-21006	COJINETE	167
18-1922	COLECTOR CODO	238	18-2100K	KIT RODAMIENTO Y RETÉN	168
18-1930S			18-2101	RODAMIENTO CARDAN	168
18-1930-HGE	COLECTOR DE ESCAPE	312	18-2103	LATIGUILLO TRIM	183
18-1931S			18-2104	CRUCETA CARDAN	167, 255, 334
18-1931-HGE	COLECTOR DE ESCAPE	312	18-2104		
18-1932S			18-2174	CRUCETA CARDAN	334
18-1932-HGE	COLECTOR DE ESCAPE	312	18-2105	LATIGUILLO TRIM ESTRIBOR	183
18-1935S			18-2106	LATIGUILLO TRIM BABOR	183
18-1935-HGE	CODO ESCAPE	313	18-2107	LATIGUILLO TRIM	183
18-19360	KIT MONTAJE	316	18-2108	LATIGUILLO DE BOMBA A CONECTOR	183
18-1936S			18-2109	LATIGUILLO TRIM	183
18-1936-HGE	CODO ESCAPE	312	18-2112	LATIGUILLO TRIM BABOR	184
18-1937			18-2113	LATIGUILLO TRIM ESTRIBOR	184
18-1937S	CODO	121	18-2114		
18-1939	CODO ESCAPE	121, 238, 313	18-2136	LATIGUILLO TRIM	184
18-1949	ESPACIADOR COLECTOR	121	18-2115		
18-1949	ESPACIADOR COLECTOR ESCAPE	314	18-2137	LATIGUILLO TRIM	184
18-1950			18-2116	LATIGUILLO TRIM	184
18-1950S	COLECTOR	118	18-2125	EJE CARDAN TRASERO	166
18-1951-1*	COLECTOR	118	18-2126	LATIGUILLO TRIM	184
18-1952			18-2128	SOPORTE CENTRAL	167, 259, 334
18-1952S	COLECTOR	118	18-2130	LEVA CAMBIO	178
18-1953			18-2138	COJINETE PIVOTE	267, 335
18-1953S	COLECTOR	118	18-2140	KIT TORNILLO SOPORTE MOTOR	149
18-1954-1*	COLECTOR	118	18-2141	KIT TORNILLO SOPORTE MOTOR	149
18-1955-1*	COLECTOR	119	18-2142	CILINDRO POWER TRIM	186
18-1956	COLECTOR	119	18-2145	CONJUNTO CABLE INVERSOR	172
18-1957	COLECTOR	119	18-2145E	CONJUNTO CABLE INVERSOR	172
18-1958-1*	COLECTOR	119	18-2146	EJE CARDAN DELANTERO	166, 255, 334
18-1960S	COLECTOR	119	18-2146	ACOPLAMIENTP EJE CRUCETA	255
18-1962-1*	COLECTOR	119	18-2146	PARTE SUPERIOR CARDAN	334
18-1966-1			18-2148	ALOJAMIENTO CILINDRO TRIM	186
18-1966-1S	COLECTOR	120			
18-19702	CODO	120			

Código	Descripción	Páginas	Código	Descripción	Páginas
18-2149	TUBO GUIA CABLE	172	18-2256	KIT ENGRANAJES SUPERIOR	165
18-2150	EJE CAMBIO	178	18-2257	KIT ENGRANAJES SUPERIOR	166
18-2151	PASADOR PIVOTE	187	18-2258	KIT ENGRANAJES SUPERIOR	166
18-2152			18-2259	KIT ENGRANAJES SUPERIOR	166
18-2153	PASADOR PIVOTE	335	18-2261	EJE TRANSMISIÓN	177
18-2154	CASQUILLO	178	18-2286	CARRETE	177
18-2156	EJE DE TILT	265	18-2196		
18-2157	CONJUNTO CABLE INVERSOR	172	18-2291	KIT AROS TÓRICOS DE TRIM	186
18-2158			18-2292	KIT DE GRUESOS	162
18-2159	CUERPO CABLE	172	18-2293	KIT DE GRUESOS	162
18-2189			18-2294	KIT DE GRUESOS	162
18-2160	TUBO SOPORTE	172	18-2295	KIT DE GRUESOS	162
18-2161	BRAZO DE CAMBIO	169	18-2298	ARANDELA CIERRE	178
18-2162	CORREDERA CABLE CAMBIO CON TORNILLO	169	18-2299	ARANDELA CIERRE	178
18-2163	TORNILLO	169	18-2303	TORNILLO RETENEDOR CABLE	172
18-2163-9					
18-2163E-9	TORNILLO	169	18-2316	ARANDELA VARILLA CAMBIO	149
18-2166	EJE TRANSMISIÓN	176	18-2316-9		
18-2169	BRAZO DE CAMBIO	169	18-2320	EJE CAMBIO	178
18-2170	TORNILLO BRAZO CAMBIO	169	18-2321	ACOPLADOR DEL MOTOR	174
18-2171	ACOPLADOR DEL MOTOR	174	18-2322	EJE INTERMEDIO	169
18-2172	ACOPLADOR DEL MOTOR	174	18-2323	ACOPLADOR DEL MOTOR	174
18-2173	ACOPLAMIENTO MOTOR	174	18-2324	EJE TRANSMISIÓN SUPERIOR	168
18-2174	CRUCETA	167, 255	18-2331	EJE TRANSMISIÓN	177
18-2175	ACOPLADOR DEL MOTOR	173	18-2336	CASQUILLO POWER TRIM	188
18-21751	ACOPLADOR DEL MOTOR	174, 259, 332	18-2336-9		
18-21752-1	DAMPER	259, 332	18-2337	UNIÓN COLA-CARDAN	254
18-21753	DAMPER	259, 332	18-2337	PARTE INFERIOR CARDAN	334
18-21754	DAMPER	259	18-2338	CARDAN COMPLETA	255
18-21755	DAMPER	259	18-2339	CARDAN COMPLETA	255
18-2176	ENGRANAJE	260	18-2339	CARDAN COMPLETA	334
18-2177	ENGRANAJE	260	18-2340	ARANDELA VARILLA CAMBIO	149
18-2179	EJE TRANSMISIÓN SUPERIOR	168	18-2340-9		
18-2180	EJE TRANSMISIÓN	177	18-2341-1	CASQUILLO POWER TRIM	188
18-2183	EJE TRANSMISIÓN	261	18-2341-1-9		
18-2184	EJE TRANSMISIÓN	262	18-2342	ARANDELA	177
18-2185	EJE TRANSMISIÓN	262	18-2343	ARANDELA TUERCA PIÑÓN	149
18-2186	EJE TRANSMISIÓN	262	18-2343-9		
18-2188	EJE TRANSMISIÓN	262	18-2345	ARO RETENEDOR CILINDRO TRIM	188
18-2187	EJE HÉLICE	262	18-2345-9		
18-2190	CONJUNTO CABLE INVERSOR	172	18-2346	COJINETE	177
18-2190E	CONJUNTO CABLE INVERSOR	172	18-2348	MUELLE TRINQUETE	176
18-2191	COJINETE DIABOLO	177	18-2489-9		
18-2192	CABLE CAMBIO ELÉCTRICO	217	18-2349	MANGUITO EJE CAMBIO	148, 182
18-2193	SILENT-BLOCK TRASERO	149	18-2353	ALOJAMIENTO COJINETE	178
18-2195	ACOPLADOR DEL MOTOR	173	18-2354	CIERRE RETÉN	178
18-2199	ESPACIADOR	332	18-2357	PASADOR	176
18-2200	KIT ENGRANAJES	175	18-2358	KIT REPARACIÓN UNIDAD SUPERIOR	164
18-2201	KIT ENGRANAJES SUPERIOR	164	18-2359	JUEGO TUERCAS EJE TRANSMISIÓN	177
18-2202	EMBRAGUE DESLIZANTE	176	18-2363	KIT REPARACIÓN UNIDAD INFERIOR	164
18-2203	KIT ENGRANAJES SUPERIOR	165	18-2364	KIT REPARACIÓN UNIDAD SUPERIOR	164
18-2204	KIT ENGRANAJES SUPERIOR	165	18-2365	KIT REPARACIÓN UNIDAD SUPERIOR	164
18-2205	KIT ENGRANAJES SUPERIOR	165	18-2366	CASQUILLO INFERIOR	334
18-2206-1	KIT ENGRANAJES PARTE INFERIOR	175	18-2367	TUERCA CABEZA CILINDRO	322
18-2216	PIÑÓN EMBRAGUE	262	18-2368	KIT CARCASA INFERIOR	176
18-2218	PIÑÓN MARCHA ADELANTE	262	18-2369	KIT CARCASA INFERIOR	176
18-2219	PIÑÓN MARCHA ATRÁS	262	18-2372	CIERRE CILINDRO TRIM	185
18-2220	PIÑÓN EMBRAGUE	262	18-2375	TAPÓN DRENAJE	182
18-2243	BOLA RETENCIÓN	261	18-2375-9		
18-2243-9					
18-2244	TAPÓN DRENAJE	182	18-2376	COJINETE DIABOLO	178
18-22441-9					
18-2245-1	CONJUNTO CABLE INVERSOR	259	18-2378	TORNILLO MAGNÉTICO DE DRENAJE	251
18-2246	CONJUNTO CABLE INVERSOR	259	18-23781-9		
18-2248	CONJUNTO CABLE INVERSOR	172	18-2381	TAPA PARTE SUPERIOR	168
18-2251	EJE HÉLICE	262	18-2382	TAPA PARTE SUPERIOR	168
18-2252	EJE HÉLICE	262	18-2383	PIÑÓN EMBRAGUE	262
18-2254	EJE TRANSMISIÓN	176	18-2387	TORNILLO DRENAJE	251
			18-23871-9		
			18-2393	PASADOR PIVOTE	187
			18-2394	PASADOR PIVOTE	187

Código	Descripción	Páginas	Código	Descripción	Páginas
18-2395	PASADOR PIVOTE	187	18-2528	ARO SOPORTE	331
18-2396	PASADOR PIVOTE	187	18-2528-9		
18-2397	PASADOR PIVOTE	187	18-2529	ARO SELLADO	331
18-2399	MUELLE TRINQUETE	265	18-2529-9		
18-2400	PARTE INFERIOR	162	18-2530	ARO SELLANTE	331
18-2401	CARCASA INFERIOR	164	18-2530-9		
18-2404	KIT REPARACIÓN ENGRANAJES	176	18-2531	ARO	331
18-2405	KIT REPARACIÓN ENGRANAJES	176	18-2533	RETÉN TRANSOM	259
18-2406	JUEGO ENGRANAJES MARCHA ADELANTE	175	18-2541	RETÉN GOMA	248
18-2407	KIT ENGRANAJES	176	18-2552	JUNTA TERMOSTATO	144
18-2408	ENGRANAJES MARCHA ATRÁS	175	18-2552-9		
18-2409	ENGRANAJES MARCHA ATRÁS	175	18-2553	JUNTA TERMOSTATO	144
18-2410	JUEGO ENGRANAJES MARCHA ADELANTE	175	18-2553-9		
18-2411	ALOJAMIENTO PARTE SUPERIOR	162	18-2554	JUNTA TERMOSTATO	144
18-2412	ACOPADOR DEL MOTOR	174	18-2554-9		
18-2413	ACOPADOR DEL MOTOR	174	18-2555	JUNTA TERMOSTATO	144
18-2414	ACOPADOR DEL MOTOR	174	18-2555-9		
18-2415	ALOJAMIENTO	163	18-2556	JUNTA TRANSOM ALPHA ONE	147
18-2416	PARTE SUPERIOR	163	18-2556-9		
18-2417	PARTE SUPERIOR	163	18-2564	JUNTA IMPULSOR	147
18-2418	PARTE SUPERIOR	163	18-2564-9		
18-2419	PARTE SUPERIOR	163	18-2565	JUNTA IMPULSOR	148
18-2420	CILINDRO POWER TRIM	186	18-2565-9		
18-2421	CILINDRO POWER TRIM	186	18-2566	JUNTA IMPULSOR	148
18-2422	CILINDRO POWER TRIM	186	18-2566-9		
18-2423	CILINDRO POWER TRIM	186	18-2583	KIT RETÉN UNIDAD INFERIOR	340
18-2424	CILINDRO POWER TRIM	186	18-2584	KIT RETÉN UNIDAD INFERIOR	340
18-2425	CILINDRO POWER TRIM	186	18-2586	KIT RETÉN UNIDAD SUPERIOR	339
18-2426	CILINDRO POWER TRIM	186	18-2596	KIT JUNTAS CULATA	326
18-2427	CILINDRO POWER TRIM	186	18-2597	KIT RETÉN UNIDAD SUPERIOR	340
18-2428	KIT REPARACIÓN CILINDRO TRIM	186	18-2598	KIT RETÉN ALOJAMIENTO ENGRANAJE	339
18-2429	KIT REPARACIÓN CILINDRO TRIM	186	18-2599	RETÉN	169
18-2432	LATIGUILLO POWER HIDRÁULICO DELANTERO	332	18-2600	KIT INFERIOR CABLE CAMBIO	173
18-2433	LATIGUILLO HIDRÁULICO DELANTERO	332	18-26002-1	KIT SISTEMA ENCENDIDO	37
18-2434	ALOJAMIENTO	53	18-2601-1	KIT RETENES TRANSOM	170
18-2435	LATIGUILLO POWER TRIM	184	18-2603	KIT INFERIOR CABLE CAMBIO	173
18-2436	LATIGUILLO POWER TRIM	184	18-2603E	KIT INFERIOR CABLE CAMBIO (EXTREME)	173
18-2443	PARTE INFERIOR	163	18-2604	KIT INFERIOR CABLE CAMBIO	173
18-2450	UNIDAD SUPERIOR COMPLETA	163	18-2604E	KIT INFERIOR CABLE CAMBIO (EXTREME)	173
18-2451	UNIDAD SUPERIOR COMPLETA	163	18-26104-1	DISTRIBUIDOR	39, 209
18-2452	UNIDAD SUPERIOR COMPLETA	163	18-26110-1	DISTRIBUIDOR	39, 209
18-2453	UNIDAD SUPERIOR COMPLETA	163	18-26111-1	DISTRIBUIDOR	37, 39, 209
18-2454	TORNILLI DRENAGE	267	18-2613	JUEGO JUNTAS COLA	246
18-2454	TAPÓN DRENAJE	335	18-2614	KIT JUNTAS ALPHA ONE	150
18-2460	KIT TAPONES	182	18-2615	KIT JUNTAS BRAVO	150
18-2461	KIT PASADOR CILINDRO TRIM	185	18-2617	KIT JUNTAS	150
18-2463	KIT PASADOR CILINDRO TRIM	186	18-2619-1	KITS JUNTAS ALPHA ONE	150
18-2464	KIT PASADOR FRONTAL Y POSTERIOR	186	18-2620	KIT JUNTAS COLA	150
18-2465-9	PAR DE PIVOTES	185	18-2622	KIT CASQUILLOS ALOJAMIENTO CAMPANA	169
18-2466-9	PAR DE PIVOTES	185	18-2625	KIT JUNTA COLAS	340
18-2496	JUNTA CULATA	143	18-2643	KIT RETENES UNIDAD SUPERIOR	190
18-25001	JUNTA TAPA VÁLVULA	146	18-2644	KIT RETENES ALOJAMIENTO	190
18-25002	JUNTA TAPA VÁLVULA	146	18-2645	KIT RETENES UNIDAD INFERIOR BRAVO	191
18-2516	JUNTA TRANSOM BRAVO	147	18-2646-1	KIT RETENES PARTE INFERIOR	190
18-2513-9			18-2648	KIT RETENES ENGRANAJES SUPERIOR	191
18-2518	JUNTA BOMBA AGUA	330	18-2649	KIT RETENES TRIM	186
18-2519	ARO SELLANTE	331	18-2652	KIT RETENES ENGRANAJE INFERIOR	191
18-2519-9			18-2664	KIT RETENES ENGRANAJE INFERIOR	268
18-2525	ARO SELLANTE	331	18-2665	KIT RETENES ENGRANAJE SUPERIOR	268
18-2525-9			18-2666	KIT RETENES ALOJAMIENTO ENGRANAJE SUPERIOR	268
18-25250	ARO SELLADO	331	18-2667	KIT RETÉN UNIDAD SUPERIOR	269
18-25251	ARO SELLADO	331	18-2669	KIT RETENES ALOJAMIENTO INTERMEDIO	269
18-2526	ARO SELLANTE	331	18-2670	KIT RETENES ALOJAMIENTO INTERMEDIO	269
18-2526-9			18-2671	KIT RETENES UNIDADES INFERIORES	269
18-2527	ARO SELLANTE	331	18-2672	KIT RETENES UNIDADES INFERIORES	270
18-2527-9			18-2673	KIT RETENES UNIDADES SUPERIORES	270
			18-2674	KIT RETENES ALOJAMIENTO TRANSOM	270
			18-26810	GM HEI 4 TERMINAL	34, 205, 288
			18-26811	GM HEI 2 TERMINAL	34, 205, 288

Código	Descripción	Páginas	Código	Descripción	Páginas
18-26812	HEI BOBINA CONECTOR	34, 205, 288	18-2818	KIT JUNTAS CARTER	327
18-26813	HEI BOBINA NEGRA CONECTOR	34, 205, 288	18-2819-1	JUNTA CODO ESCAPE	124, 145
18-2699	JUEGO JUNTAS KIT MONTAJE	246, 326	18-2819-9	JUNTA TRANSOM ALPHA ONE	147
18-2701	CASQUILLO POWER TRIM	188	18-2820	JUNTA BOMBA DE AGUA INFERIOR	148
18-2701-04			18-2820-9	JUNTA BOMBA DE AGUA SUPERIOR	148
18-2701-9			18-2823	JUNTA BOMBA DE AGUA SUPERIOR	148
18-2702	CASQUILLO POWER TRIM	188	18-2823-9	JUNTA BASE BOMBA DE AGUA	148
18-2702-04			18-2824	JUNTA BASE BOMBA DE AGUA	148
18-2702-1-9			18-2824-9	JUNTA BASE BOMBA DE AGUA	148
18-2715	KIT VÁLVULA ACEITE	169	18-2825	JUNTA BASE BOMBA DE AGUA	148
18-2724	GOMA CIERRE TRANSOM	169	18-2825-9	JUNTA BASE BOMBA DE AGUA	148
18-2726	KIT RETÉN UNIDAD SUPERIOR	339	18-2826	JUNTA COLECTOR ESCAPE	124, 145, 248
18-2727	VÁLVULA ESCAPE ANTI-RETORNO	83	18-2826-9	JUNTA TERMOSTATO	144
18-2732	VÁLVULA ESCAPE ANTI-RETORNO	83	18-2830-1	JUNTA TERMOSTATO	144
18-2733	VÁLV.ESCAPE ANTI-RETORNO	83	18-2831-9	JUNTA COLECTOR	124, 145,
18-2743	JUNTA TRANSOM ALPHA ONE	147	18-2832-1	JUNTA COLECTOR ESCAPE	124, 145
18-2744	KIT FUELLE TRANSMISIÓN	333	18-2832-1-9	JUNTA TERMOSTATO	144
18-2745	TUBO ESCAPE	259	18-2833	JUNTA TAPA VÁLVULA	249
18-2746CEF	TUBO ESCAPE	171	18-2833-9	JUNTA TRANSOM	147
18-2746S			18-2834	JUNTA BASE CARBURADOR	144
18-2747CEF	FUELLE	171	18-2834-9	JUNTA COLECTOR ESCAPE	145
18-2747S			18-2840	JUNTA COLECTOR ESCAPE	124
18-2748CEF	TUBO ESCAPE	171	18-2840-9	JUNTA TAPA VÁLVULA	249
18-2748S			18-2843	JUNTA TAPA VÁLVULA	249
18-2750CEF	FUELLE	171	18-2843-9	JUNTA TRANSOM	147
18-2750S			18-2844	JUNTA TRANSOM	147
18-2751CEF	FUELLE TRANSMISIÓN	171	18-2844-9	JUNTA BASE CARBURADOR	144
18-2751S			18-2845	JUNTA BASE CARBURADOR	144
18-2752CEF	FUELLE TRANSMISIÓN	171	18-2845	JUNTA TAPA VÁLVULA	249
18-2752S			18-2845	JUNTA TAPA VÁLVULA	249
18-2753CEF	FUELLE CABLE CAMBIO	171	18-2847	JUNTA TRANSOM	147
18-2753S			18-2847-9	JUNTA TRANSOM	147
18-2755	KIT FUELLE TRANSMISIÓN	333	18-2848	JUNTA TRANSOM	147
18-2756CEF	FUELLE TRANSMISIÓN	171	182848-9	JUNTA BASE CARBURADOR	144
18-2756S			18-2849-1	JUNTA BASE CARBURADOR	144
18-2757	KIT FUELLE DE ESCAPE	333	18-2849-9-1	JUNTA COLECTOR ESCAPE	145
18-2758	KIT FUELLE DE ESCAPE	333	18-2849-9-1	JUNTA COLECTOR ESCAPE	124
18-2759CEF	TUBO ESCAPE	171	18-2849-1(abierto)	JUNTA COLECTOR ESCAPE	124
18-2760CEF	TUBO ESCAPE	171	18-2849-9-1	JUNTA COLECTOR ESCAPE	124
18-2760S			18-2850	JUNTA COLECTOR ESCAPE	240
18-2761CEF	TUBO ESCAPE	171	18-2850-9	JUNTA COLECTOR ESCAPE	240
18-2761S			18-2850	JUNTA TAPA COLECTOR	248
18-2762CEF	TUBO ESCAPE	171	18-2850-9	JUNTA TAPA COLECTOR	248
18-2763	FUELLE CABLE CAMBIO	259	18-2851	JUNTA COJINETE	250
18-2765	FUELLE TRANSMISIÓN	259	18-2851-9	JUNTA COJINETE	250
18-2765S			18-2854-1	JUNTA COLECTOR ESCAPE	124, 240,316
18-2765	FUELLE TRANSMISIÓN	333	18-2854-9	JUNTA COLECTOR ESCAPE	124, 240,316
18-2765S			18-2858	JUNTA COLECTOR ESCAPE	240, 248
18-2766	MANGUITO ESCAPE	333	18-2858-9	JUNTA ALOJAMIENTO TAPA TERMOSTATO	247, 329
18-2767	RETÉN TRANSOM	259	18-2859	JUNTA TAPA COLECTOR	248
18-2768	RETÉN TRANSOM	259	18-2859-9	JUNTA TAPA COLECTOR	248
18-2770CEF	TUBO ESCAPE	171	18-2860	JUNTA TAPA COLECTOR	248
18-2771	KIT FUELLES	258	18-2860-9	JUNTA TAPA COLECTOR	248
18-2772-1	KIT RETÉN TRANSOM	258, 333	18-2861-1	JUNTA COLECTOR ESCAPE	240, 248
18-2774	MANGUITO	318	18-2861-9	JUNTA COLECTOR ESCAPE	240, 248
18-2775	MANGUITO	318	18-2863	JUNTA TAPA TILT	250
18-2776	MANGUITO	318	18-2863-9	JUNTA TAPA TILT	250
18-2777	JUEGO JUNTAS REFRIGERACIÓN	318	18-2875-1	JUNTA COLECTOR ESCAPE	240, 248, 316
18-2778	ALOJ. TERMOSTATO	318	18-2875-1-9	JUNTA COLECTOR ESCAPE	240, 248, 316
18-2779	MANGUERA ESCAPE	239, 306	18-2883-1	JUNTA TAPA COLECTOR	248
18-2779S			18-2883-1-9	JUNTA TAPA COLECTOR	248
18-2780-1	MANGUITO	306	18-2896	JUNTA COLECTOR ESCAPE	124, 145, 248
18-2781	MANGUERA ESCAPE	239, 306	18-2896-1	JUNTA COLECTOR ESCAPE	124, 145, 248
18-2781S			18-2902-1	JUNTA COLECTOR ESCAPE	124, 145, 248
18-2783	KIT RETÉN UNIDAD INFERIOR	270	18-2902-9	JUNTA COLECTOR ESCAPE	124, 145, 248
18-2791	KIT RETENES COLA	270, 340	18-2909	JUNTA COLECTOR ESCAPE	124, 146, 329, 249
18-2793	KIT RETENES	322	18-2909-9	JUNTA COLECTOR ESCAPE	124, 146, 329, 249
18-2813	KIT JUNTAS CULATA	326	18-2911	JUNTA ALOJAMIENTO COJINETE CARDAN	251
18-2814	JUEGO JUNTAS BLOQUE CORTO	326	18-2911-9	JUNTA ALOJAMIENTO COJINETE CARDAN	251
18-2815	JUNTA TAPA VARILLA EMPUJE	147, 250, 329	18-2912-1	JUNTA COLECTOR ESCAPE	124, 146, 248
18-2817	KIT JUNTAS CULATA	327	18-2914	JUNTA BOMBA AGUA	148
			18-2914-9	JUNTA BOMBA AGUA	148
			18-2915	JUNTA BOMBA AGUA	148
			18-2915-9	JUNTA BOMBA AGUA	148
			18-2916	JUNTA ALOJAMIENTO BOMBA AGUA	250
			18-2916-9	JUNTA ALOJAMIENTO BOMBA AGUA	250
			18-2917	JUNTA TERMOSTATO	144, 247
			18-2917-9	JUNTA TERMOSTATO	144, 247

Código	Descripción	Páginas	Código	Descripción	Páginas
18-2918	JUNTA TRANSOM	148, 251	18-3060	IMPULSOR	307
18-2918-9			18-3061	IMPULSOR	307
18-2922	JUNTA COLECTOR ESCAPE	329	18-3075	KIT IMPULSOR	307
18-2923	JUNTA TAPA VÁLVULA	330	18-3076	KIT IMPULSOR	307
18-2924	JUNTA TAPA VÁLVULA	330	18-3077	KIT BOMBA AGUA	307
18-2925	JUNTA COLECTOR ESCAPE	329	18-3038		
18-2926	JUNTA CARTER	330	18-30778	IMPULSOR	307
18-2927	JUNTA TAPA VÁLVULA	330	18-3078	KIT BOMBA AGUA	307
18-2928	JUNTA COLECTOR ESCAPE	329	18-3037	KIT IMPULSOR	307
18-2929	JUNTA PLATINA	332	18-3079		
18-2929-9			18-3080	KIT BOMBA AGUA	308
18-2930	JUNTA COLECTOR ESCAPE	329	18-3036	KIT IMPULSOR	308
18-29322	KIT TAPA Y ROTOR	205, 282	18-3081		
18-2933	JUNTA TERMOSTATO	329	18-3086	IMPULSOR	228
18-2933-9			18-3087	IMPULSOR	82
18-2934	RETÉN GOMA	331	18-3089	KIT BOMBA AGUA	308
18-2934-9			18-3106	ACOPLAMIENTO BOMBA AGUA	306
18-2935	RETÉN GOMA	331	18-3108	LLAVE IMPULSOR	230
18-2935-9			18-3109	TUBO GUIA	82
18-2936	RETÉN GOMA	331	18-3110	CASQUILLO	82
18-2936-9			18-3111	RETÉN EJE BOMBA AGUA	230
18-2937	RETÉN GOMA	331	18-3114	CASQUILLO IMPULSOR	83
18-2937-9			18-3116	BOMBA AGUA ALOJAMIENTO	83
18-2939	RETÉN GOMA	332	18-3117	PLATINA IMPULSOR	83
18-2939-9			18-3119	ALOJAMIENTO BOMBA AGUA	230
18-29417	TAPA DISTRIBUIDOR	33	18-3121	PLATINA IMPULSOR	230
18-2944	JUNTA TÓRICA	148	18-3122	PLATINA IMPULSOR	83
18-2944-9			18-3141	PLATINA IMPULSOR	230
18-2945	JUNTA TORNILLO DRENAJE	251	18-3145	CASQUILLO TURBINA	230
18-2945-9			18-3147	KIT BOMBA AGUA	84
18-2945	JUNTA TORNILLO DRENAJE	148	18-3150	KIT BOMBA AGUA	84
18-2945-9			18-3151	ALOJAMIENTO	83
18-29451-9	18-3155	KIT REPARACIÓN BOMBA AGUA	84		
18-2946	JUNTA CULATA	143, 247, 327	18-3160	BOMBA AGUA MAR, BRONCE	84
18-2947	JUNTA TERMOSTATO	248	18-3175	ACOPLAMIENTO BOMBA AGUA	306
18-2947-9			18-3197	TORNILLO	83
18-2948	ARANDELA DE GOMA	148	18-3198	REJILLA TOMA DE AGUA	178
18-2948-9	JUNTA COLECTOR ESCAPE	124, 146, 240, 317, 330	18-3199	REJILLA TOMA DE AGUA	178
18-2949			18-3200	ARANDELA	182
18-2949-9	18-3205	KIT REPARACIÓN	308		
18-2965	JUNTA CULATA	327	18-3206	ALOJAMIENTO BOMBA AGUA	230
18-2966	JUNTA CULATA	327	18-3208	KIT REPARACIÓN BOMBA AGUA	308
18-2968	JUNTA CULATA	328	18-3209	KIT REPARACIÓN BOMBA AGUA	308
18-2970	JUNTA CULATA	328	18-3212-1	KIT REPARACIÓN IMPULSOR	231
18-2971-1	JUNTA COLECTOR ESCAPE	317, 329	18-3214	KIT REPARACIÓN IMPULSOR	84
18-2972	JUNTA TAPA VÁLVULA	330	18-3216	KIT IMPULSOR	84
18-2974	JUNTA TAPA VÁLVULA	330	18-3217	KIT IMPULSOR	84
18-2979-9	JUNTA BOMBA AGUA	331	18-3219	KIT REFRIGERACIÓN	169
18-2980	KIT JUNTAS CULATA	327	18-3220	TUBO DE AGUA	83
18-2982	KIT JUNTAS CULATA	327	18-3221	TUBO DE AGUA	83
18-2983	KIT JUNTAS CARTER	327	18-3222	TUBO DE AGUA	83
18-2989	JUNTA MONTAJE CARBURADOR	329	18-3226	TORNILLO BOMBA IMPULSOR	83
18-2989-9			18-3227	CLAVIJA BASE BOMBA	83
18-2990	JUNTA ALOJAMIENTO	332	18-3229	TORNILLO	83
18-2990-9			18-3232	TAPÓN	188
18-2991-1	JUNTA COLECTOR ESCAPE	317, 330	18-3232-9		
18-2991-9			18-3236	CASQUILLO ALINEAMIENTO ALOJAMIENTO	149
18-2995	JUNTA INTERCAMBIADOR CALOR	329	18-3237	KIT REPARACIÓN IMPULSOR	84
18-2995-9			18-3261	KIT REPARACIÓN BOMBA AGUA	308
18-2996	JUNTA RETÉN	251, 332	18-3262	KIT REPARACIÓN BOMBA AGUA	308
18-2996-9			18-3263	KIT REPARACIÓN BOMBA AGUA	308
18-2998	KIT JUNTAS CULATA	327	18-3274	CHAVETA IMPULSOR	307
18-3007	IMPULSOR	82	18-3275	KIT IMPULSOR	307
18-3016-1	KIT IMPULSOR	82	18-3276-1	KIT IMPULSOR	307
18-3017	IMPULSOR	82	18-3277	KIT IMPULSOR	307
18-3046	IMPULSOR	307	18-3286	KIT REPARACIÓN IMPULSOR	231
18-3047	KIT IMPULSOR	307			
18-3056	IMPULSOR	82			
18-3058 CEF	IMPULSOR	228			
18-3058S					
18-30585	IMPULSOR	228			

Código	Descripción	Páginas	Código	Descripción	Páginas
18-3287	KIT IMPULSOR	307	18-3610	TUERCA RETENEDOR	264
18-32882	RETÉN TURBO AGUA	340	18-3611	JUEGO JUNTAS CARTER	142
18-3289	RETÉN DOBLE CAMBIO	148	18-3615	TERMOSTATO AGUA	319
18-3293	CHAVETA	83	18-3617	KIT TERMOSTATO	319
18-3309	KIT BOMBA AGUA	84	18-3618	KIT TERMOSTATO REFR. AGUA	319
18-33104	INYECTOR COMBUSTIBLE	62	18-3619	KIT TERMOSTATO REFR. AGUA DULCE	319
18-3317	KIT BOMBA AGUA	85	18-3620	KIT TERMOSTATO	319
18-3318	KIT BOMBA AGUA	84	18-3621	KIT TERMOSTATO	319
18-3320	KIT BOMBA AGUA	85	18-3626	KIT TERMOSTATO	319
18-33207	REGULADOR DE PRESIÓN COMBUSTIBLE	61	18-3653	KIT TERMOSTATO	231
18-3321	KIT BOMBA AGUA	85	18-3654	KIT TERMOSTATO	319
18-33211	REGULADOR DE PRESIÓN COMBUSTIBLE	61	18-3656	KIT TERMOSTATO	319
18-3348	KIT COMPLETO BOMBA AGUA	231	18-3658	KIT TERMOSTATO	319
18-3349	KIT ALOJAMIENTO BOMBA AGUA	231	18-3659	KIT TERMOSTATO	319
18-3350	PLATINA DESGASTE	83	18-3660	KIT TERMOSTATO	319
18-3351	PLATINA DESGASTE	83	18-3662	KIT TERMOSTATO	319
18-33800	PCV VÁLVULA	61, 305	18-3663	KIT RETENES ENGRANAJE INFERIOR	268, 319
18-3386	KIT BOMBA AGUA	231	18-3664	KIT TERMOSTATO	319
18-34075	KIT ESPACIADOR CARB	70	18-3665	KIT TERMOSTATO	319
18-34080	CARBURADOR 600CFM	366	18-3666	KIT TERMOSTATO	319
18-34081	CARBURADOR 750CFM	366	18-3670	KIT TERMOSTATO	232, 319
18-34082	COLECTOR DE ADMISIÓN DE AGUA	366	18-3676	KIT TERMOSTATO	232, 319
18-34083	COLECTOR DE ADMISIÓN DE AGUA	366	18-3677	KIT TERMOSTATO	232, 319
18-34084	COLECTOR DE ADMISIÓN DE AGUA	366	18-3679	TERMOSTATO	318
18-3417	BASE BOMBA AGUA	83	18-3680	KIT TERMOSTATO	318
18-3420	BASE BOMBA AGUA	83	18-3681	KIT TERMOSTATO	318
18-3421	BASE BOMBA AGUA	83	18-36905	FLOTADOR	300
18-3469	KIT REPARACIÓN BOMBA AGUA	231	18-36906	FLOTADOR CARB	71
18-3502	MANGUERA BOMBA	230	18-3700	TUERCA HÉLICE	183
18-3504	KIT IMPULSOR	307	18-3701	KIT TUERCAS HÉLICE	182
18-3506	BOMBA DE CIRCULACIÓN	82	18-3705	TUERCA HÉLICE	265
18-3506	BOMBA DE CIRCULACIÓN	306	18-3705-9	TUERCA HÉLICE	265
18-3513	BOMBA DE CIRCULACIÓN	306	18-3706-1	TUERCA HÉLICE Y RETENEDOR	265
18-3517	KIT BOMBA AGUA	85	18-3708-1	TUERCA HÉLICE	335
18-3531	TERMOSTATO ALOJAMIENTO	89	18-3712	ARANDELA	168
18-3538	KIT TERMOSTATO	319	18-3713	TUERCA	168
18-3539	KIT TERMOSTATO	319	18-3714	ARANDELA DE BRONCE	183
18-35433	BOMBA COMBUSTIBLE ELÉCTRICO	75	18-3715	KIT TUERCAS HÉLICE	265
18-35436	BOMBA COMBUSTIBLE ELÉCTRICA	362	18-3716	KIT TUERCAS HÉLICE	265
18-35437	BOMBA COMB	75	18-3719	TUERCA PIÑÓN	177, 260
18-35442	BOMBA COMBUSTIBLE	301	18-3720	TUERCA	185
18-35443	BOMBA COMBUSTIBLE	344	18-3721	TUERCA	185
18-35444	BOMBA COMBUSTIBLE	344	18-3722	TUERCA	185
18-3549	TERMOSTATO	88	18-3723	TUERCA	185
18-3550	TERMOSTATO	88	18-3721	TUERCA AUTOBLOCANTE	149
18-3551	TERMOSTATO	88	18-3721-9	TUERCA AUTOBLOCANTE	149
18-3552	TERMOSTATO	88	18-3722	TUERCA	267, 335
18-3554	TERMOSTATO	231	18-3722-9	TUERCAS APRIETE ACERO INOXIDABLE	267, 335
18-3555	TERMOSTATO	88	18-3725	TUERCA	260
18-3557	TERMOSTATO	318	18-3725-9	TUERCA	260
18-3558	TERMOSTATO	231	18-3728	TUERCA AUTOBLOCANTE	149
18-3558	TERMOSTATO	318	18-3729	TORNILLO	149
18-3573	BOMBA AGUA CIRCULACIÓN	82	18-3730	TUERCA MONTAJE FUERABORDA	265, 334
18-3575	BOMBA CIRCULACIÓN AGUA	82, 227, 306	18-3731	TUERCA	260
18-3577-1	BOMBA AGUA CIRCULACIÓN	82, 227, 306	18-3731-9	TUERCA	260
18-3578	BOMBA DE CIRCULACIÓN AGUA	227	18-3733	KIT TUERCAS HÉLICE	265
18-3584	BOMBA AGUA CIRCULACIÓN	82, 227, 306	18-3733	KIT MONTAJE HÉLICE	335
18-3586	BOMBA AGUA	306	18-3741	PASADORES	265
18-3593	BOMBA AGUA CIRCULACIÓN	82, 306	18-3742	PASADOR	335
18-3599	BOMBA DE CIRCULACIÓN AGUA	227	18-3744	PASADOR	335
18-3599-1	BOMBA AGUA CIRCULACIÓN	82, 306	18-3744-9	PASADOR	335
18-3600	BOMBA AGUA MAR	84	18-3745	PASADOR	335
18-36001	BOMBA AGUA MAR	84	18-3745-9	PASADOR	335
18-3601	MANGUERA ENTRADA AGUA	97	18-3749	EJE SUPERIOR CAMBIO	169
18-3602	MANGUERA ENTRADA AGUA	97	18-3751	TUERCA	178
18-3603	MANGUERA ENTRADA AGUA	97	18-3752	TUERCA RETENCIÓN ALOJAMIENTO EJE TRANSMISIÓN	169
			18-3754	CABLE ANCLAJE	173
			18-3755	KIT TUERCAS HÉLICE	182
			18-3756	KIT TUERCAS HÉLICE	182

Código	Descripción	Páginas	Código	Descripción	Páginas
18-3759	ARANDELA EMPUJE	177	18-4228	ESPACIADOR HÉLICE	265
18-3760	KIT COJINETE CAMPANA	169	18-4231	ESPACIADOR HÉLICE	265
18-3763	EJE CAMBIO	254	18-4236	ARANDELA	318
18-3766	BASE CAMBIO	264	18-4236-9	ARANDELA	318
18-3768	TUERCA TAPA	264	18-4238	TORNILLO CIERRE	335
18-3769	TUERCA PIÑÓN	260	18-4238-9	TORNILLO CIERRE	335
18-3770	TUERCA	255	18-4239	PALOMILLA CIERRE	335
18-3783	TUERCA HÉLICE	182	18-4241	PASADOR	335
18-3784	ARANDELA EMPUJE	182	18-4241-9	PASADOR	335
18-3785	TUERCA HÉLICE	182	18-4248	ARANDELA	251
18-3786	TUERCA HÉLICE	182	18-4248-9	ARANDELA	251
18-3787	ARANDELA	182	18-4248-9-9	ARANDELA	251
18-3788-9	ARANDELA	182	18-4250	ARANDELA	251
18-3834	JUNTA CULATA	328	18-4250-9	ARANDELA	251
18-3842	JUNTA CULATA	328	18-4251	TAPÓN VACIADO DE LATÓN	260
18-3867	JUNTA CULATA	328	18-4251-9	TAPÓN VACIADO DE LATÓN	260
18-3868	JUNTA CULATA	328	18-4252	MUELLE DE CONTINUIDAD	187
18-3869	JUNTA CULATA	328	18-4252-9	MUELLE DE CONTINUIDAD	187
18-3870	KIT JUNTAS CULATA	326	18-4253-9	ARO TÓRICO TORNILLO DRENAJE	251
18-3874	JUNTA CULATA	143	18-42531-9	ARO TÓRICO TORNILLO DRENAJE	251
18-3874	JUNTA CULATA	247	18-4256	TAPONES	238
18-3876	JUNTA CULATA	143, 247, 328	18-4257	TAPONES	238
18-3877	JUNTA CULATA	143, 247	18-4258	TAPONES	238
18-3878	JUNTA CULATA	143, 247	18-4263	TAPONES	238
18-3879	JUNTA CULATA	143, 247, 328	18-4264	TAPONES	238
18-3880	JUNTA CULATA	143, 247	18-4259	ARANDELA	331
18-3881	JUNTA CULATA	143, 247	18-4267	ARANDELA	149
18-3883	JUNTA CULATA	143, 247, 328	18-4267-9	ARANDELA	149
18-3887	JUNTA CULATA	143, 247, 328	18-4270	ARANDELA	149
18-3888	KIT RETÉN UNIDAD INFERIOR	340	18-4270-9	ARANDELA	149
18-3889	JUEGO JUNTAS PIPETA REFRIGERACIÓN	318	18-4272	TAPA	149
18-3890	JUEGO JUNTAS REFRIGERACIÓN	318	18-4273	TAPA	149
18-3893	KIT JUNTAS CAMBIO	339	18-4288	CASQUILLO POWER TRIM	188
18-4005	SILENTBLOCK	322	18-4288-9	CASQUILLO POWER TRIM	188
18-4008	JUNTA TAPA ESCAPE	122	18-4289	ARO RETENEDOR	188
18-4009	TAPA LATERAL COLECTOR	122, 238	18-4289-9	ARO RETENEDOR	188
18-4022	RETÉN VÁLVULA	137	18-4295	CLIP	178
18-4023	RETÉN VÁLVULA	137	18-4295-9	CLIP	178
18-4024	RETÉN VÁLVULA	137, 251, 325	18-4296	SEPARADOR	169
18-4024-9	RETÉN VÁLVULA	137, 251, 325	18-4341	KIT JUNTAS CULATA	326
18-4029	CORREA DISTRIBUCIÓN	321	18-4342	KIT JUNTAS CULATA	326
18-4031	RETÉN VÁLVULA	325	18-4347-1	JUEGO DE JUNTAS COLECTOR DE ESCAPE	138
18-4044	CORREA	321	18-4348	JUEGO DE JUNTAS COLECTOR DE ESCAPE	138
18-4046	CORREA	321	18-4349	JUEGO DE JUNTAS COLECTOR DE ESCAPE	138
18-4150	EJE BOMBA AGUA	318	18-4362	KIT DE MONTAJE CODO DE ESCAPE	122
18-4194	ESPACIADOR HÉLICE	265, 335	18-4363	KIT DE MONTAJE CODO DE ESCAPE	122, 239
18-4204	CASQUILLO PLÁSTICO	334	18-4364	KIT DE MONTAJE CODO DE ESCAPE	122, 239, 314
18-4205	CASQUILLO PLÁSTICO	334	18-4365	JUEGO DE JUNTAS COLECTOR ESCAPE	140
18-4206	TAPA COLAS	334	18-4366	JUEGO JUNTAS CARTER	142
18-4208	FISH LINE PROTECTOR ESPACIADOR	334	18-4367	JUEGO DE JUNTAS COLECTOR DE ESCAPE	138
18-4209	FISH LINE PROTECTOR ESPACIADOR	334	18-4369	JUEGO JUNTAS COLECTOR ESCAPE	246
18-4210	CONO HÉLICE	334	18-4370	JUEGO JUNTAS COLECTOR	246
18-4211	ARANDELA PLÁSTICO	334	18-4371	JUEGO JUNTAS COLECTOR ESCAPE	246
18-4212	TORNILLO CONO HÉLICE	335	18-4373	JUEGO JUNTAS	246
18-4213	ESPACIADOR	335	18-4374	JUEGO JUNTAS	246
18-4214	ARANDELA CIERRE	335	18-4375	KIT DE JUNTAS CADENA DISTR.	142
18-4215	TORNILLO TAPA DE COLA	335	18-4380	KIT DE JUNTAS CADENA DISTR.	142
18-4218	TAPÓN VACIADO	125	18-4383	JUEGO JUNTAS CULATA Y COLECTOR DE ESCAPE	139
18-4218	TAPÓN VACIADO DE LATÓN	238	18-4384	JUEGO JUNTAS CULATA Y COLECTOR DE ESCAPE	139
18-4220	ARANDELA EMPUJE	182	18-4386	JUEGO JUNTAS CULATA Y COLECTOR DE ESCAPE	140
18-4222	ARANDELA	265	18-4385	JUEGO JUNTAS CULATA Y COLECTOR DE ESCAPE	140
18-4223	ARANDELA	265	18-4387	JUEGO JUNTAS CULATA Y COLECTOR DE ESCAPE	140
18-4224	ACOPLOAMIENTO CODO	125	18-4388	JUEGO JUNTAS COMPLETO	140
18-4226	TAPÓN	125	18-4389	JUEGO JUNTAS COLECTOR ADMISIÓN	140
18-4227	CODO	125	18-4391	JUEGO JUNTAS COLECTOR ADMISIÓN	140
			18-4392	JUEGO JUNTAS COLECTOR ADMISIÓN	140
			18-4394	JUEGO DE JUNTAS COLECTOR DE ESCAPE	138
			18-4395	JUEGO DE JUNTAS COLECTOR DE ESCAPE	139
			18-4396	JUEGO DE JUNTAS COLECTOR DE ESCAPE	139
			18-4397	JUEGO DE JUNTAS COLECTOR DE ESCAPE	139
			18-4398	JUEGO DE JUNTAS COLECTOR DE ESCAPE	139
			18-4399	JUEGO DE JUNTAS COLECTOR DE ESCAPE	139

Código	Descripción	Páginas	Código	Descripción	Páginas
18-4408	JUEGO DE JUNTAS COLECTOR DE ADMISIÓN	138	18-4835	CONO	260
18-4408	JUEGO JUNTAS COLECTOR ENTRADA	246	18-4837	TAPA PASO DE AGUA	230
18-4408	JUEGO DE JUNTAS COLECTOR ADMISIÓN	316	18-5001	KIT ENCENDIDO	202
18-44092	MANGUITO	97	18-5021	JUNTA TAPA ESCAPE	122
18-4442	HERRAMIENTA ALINEACIÓN	175,254	18-5107-1	MODULO DE ENCENDIDO	34, 204, 283
18-4444	HERRAMIENTA TUERCA HÉLICE	183, 265	18-5108	SENSOR BOBINA DE PICK-UP	34, 204, 283
18-4446	KIT HERRAMIENTA TUERCA HÉLICE	183	18-5116-1	KIT SENSOR ENCENDIDO	34
18-4456	TAPA ESCAPE	192	18-5117	MODULO DE ENCENDIDO	34
18-4457	TAPA ESCAPE	192	18-5157	JUEGO CONTACTO	203
18-4458	TAPA ESCAPE	192	18-5200	CONDENSADOR	203
18-4459	HERRAMIENTA TUERCA HÉLICE	183	18-5224	CABLE TERMINAL ENCENDIDO	50, 211, 288
18-4461	CONECTOR MANGUITO	125, 238, 317	18-5224-9		
18-4465	VÁLVULA GUÍA	321	18-5225	KIT CABLE BUJÍAS	50, 211
18-4472	ELEV. VÁLVULA	321	18-5226	CABLE ENCENDIDO alma metálica	50, 211
18-4473	VÁLVULA GUÍA	321	18-5226	CABLE ENCENDIDO alma metálica	288
18-4474	VÁLVULA GUÍA	321	18-5239	KIT CONVERSIÓN ELECTRÓNICA	285
18-4484HP	CULATA	363	18-5240	KIT CONVERSIÓN ELECTRÓNICA ALTO RENDIMIENTO	285
18-4485	CULATA	363	18-5243	TAPA DISTRIBUIDOR	32
18-4485 HP	CULATA	129, 242, 323, 363	18-5243	TAPA DISTRIBUIDOR	283
18-4486	CULATA	129, 242, 323, 363	18-5244	TAPA DISTRIBUIDOR	32, 283
18-4486HP	CULATA	129, 242, 323, 363	18-5245	ROTOR	32, 281
18-4486HP	CULATA	363	18-5246	KIT ENCENDIDO	30, 281
18-4488	COLECTOR ADMISIÓN, HIERRO FUNDIDO	362	18-5247	KIT ENCENDIDO	30, 281
18-4489	CULATA	363	18-5248	TAPA DISTRIBUIDOR	204, 282
18-4491	CULATA	364	18-5250	KIT ENCENDIDO	30, 202
18-4492	CONJUNTO DE BALANCINES	130	18-5251	KIT ENCENDIDO	30, 202
18-4492	CONJUNTO BALANCIN	363	18-5252	KIT ENCENDIDO	30, 202
18-4496HP	CULATA	364	18-5253	KIT ENCENDIDO	30
18-4497	TAPA DISTRBUCCIÓN	364	18-5254	KIT ENCENDIDO	30
18-4501	CULATA	129, 242, 323, 364	18-5256	KIT ENCENDIDO	202,281
18-4501HP	CULATA	129, 242, 323, 364	18-5258	KIT ENCENDIDO	30, 202
18-4506	PLACAS GUÍA	362	18-5260	KIT ENCENDIDO	30, 202, 281
18-4507	KIT BALANCINES (4 VÁLVULAS)	363	18-5264	KIT ENCENDIDO	281
18-4508	KIT TORNILLERIA	362	18-5265	KIT ENCENDIDO	281
18-4511	TAPA DISTRBUCCIÓN	364	18-5266	KIT ENCENDIDO	30, 202, 281
18-4512	TAPA DISTRBUCCIÓN	364	18-5267	KIT ENCENDIDO	30
18-4513	TAPA DISTRBUCCIÓN	364	18-5268	KIT ENCENDIDO	30, 202
18-4514	TAPA DISTRBUCCIÓN	364	18-5269	KIT ENCENDIDO	30, 202
18-4516	ARO ENGRANAJE VOLANTE	364	18-5271	KIT ENCENDIDO	30, 202
18-4517	ARO ENGRANAJE VOLANTE	364	18-5272	KIT ENCENDIDO	202
18-4518	VOLANTE	364	18-5273	KIT ENCENDIDO	30
18-4519	VOLANTE	364	18-5274	KIT ENCENDIDO	31
18-4521	VOLANTE	364	18-5275	KIT ENCENDIDO	31, 202
18-4522	VOLANTE	364	18-5276	KIT ENCENDIDO	31, 203
18-4523	VOLANTE	365	18-5277	KIT ENCENDIDO	31, 203
18-45714	IMPULSOR F75B	358	18-5278	KIT ENCENDIDO	31, 203
18-4726	VÁLVULA RETÉN	365	18-5279	KIT ENCENDIDO	203
18-4727	VÁLVULA MUELLE	365	18-5280	KIT ENCENDIDO	31, 203
18-4728	VÁLVULA MUELLE	365	18-5281	KIT ENCENDIDO	31, 203
18-4729	VÁLVULA RETENEDORA, VORTEC	365	18-5282	KIT ENCENDIDO	31
18-4730	VÁLVULA RETENEDORA	365	18-5283	KIT ENCENDIDO	31, 203
18-4731	BLOQUEO DE VÁLVULA	365	18-5284	KIT ENCENDIDO	281
18-4732	VÁLVULA ADMISIÓN	365	18-5285	KIT CONVERSIÓN ELECTRÓNICO ALTO RENDIMIENTO	35, 206
18-4733	VÁLVULA ESCAPE	365	18-5286	KIT CONVERSIÓN ELECTRÓNICO ALTO RENDIMIENTO	35
18-4734	VÁLVULA ADMISIÓN	365	18-5287-1	KIT CONVERSIÓN ELECTRÓNICA ALTO RENDIMIENTO	206
18-4735	VÁLVULA ADMISIÓN	365	18-5288	KIT CONVERSIÓN ELECTRÓNICO ALTO RENDIMIENTO	35, 206, 285
18-4736	VÁLVULA ESCAPE	365	18-5289	KIT CONVERSIÓN	35, 206, 285
18-4737	TORNILLO	365	18-5290	KIT CONVERSIÓN ELECTRÓNICO ALTO RENDIMIENTO	35, 206
18-4750	TAPA	264	18-5291	KIT ENCENDIDO	30
18-4801	PARTE INFERIOR COLA	254	18-5292	KIT CONVERSIÓN ELECTRÓNICA	285
18-4828	COJINETE PIÑÓN	264	18-5293-1	KIT CONVERSIÓN ELECTRÓNICA	206
18-4833	ALOJAMIENTO PASO DE AGUA	230	18-5294	KIT CONVERSIÓN ELECTRÓNICO	35, 206, 285
			18-5295	KIT CONVERSIÓN ELECTRÓNICO	35, 206, 285
			18-5296-2	KIT CONVERSIÓN ELECTRÓNICO	35, 207
			18-5297	KIT CONVERSIÓN ELECTRÓNICO	35, 207
			18-5298	KIT CONVERSIÓN ELECTRÓNICO	35, 207

Código	Descripción	Páginas	Código	Descripción	Páginas
18-5299	KIT CONVERSIÓN ELECTRÓNICO	35, 207, 285	18-5432	ROTOR	32
18-5300	ROTOR	32	18-5433	BOBINA ENCENDIDO	34, 205, 283
18-5301	KIT ENCENDIDO	31, 204, 282	18-5436	BOBINA ENCENDIDO	283
18-5302	KIT ENCENDIDO	31, 204, 282	18-5437	BOBINA ENCENDIDO	205, 283
18-5303	JUEGO DE CONTACTOS	31, 203, 281	18-5438	BOBINA ENCENDIDO	34
18-5305	JUEGO DE PLATINOS	281	18-5442	BOBINA ENCENDIDO	34
18-5306	JUEGO DE PLATINOS	281	18-5443	BOBINA ENCENDIDO	34, 205, 283
18-5309-1	DISTRIBUIDOR	38, 209	18-5464	MODULO DE ENCENDIDO	34
18-5310	JUEGO DE CONTACTOS	31, 281	18-5465	BOBINA ENCENDIDO	34
18-5311	JUEGO DE CONTACTOS	31, 203	18-5466	BOBINA ENCENDIDO ALTO RENDIMIENTO	33, 205, 283
18-5312-1	DISTRIBUIDOR	38, 209	18-5467	BOBINA ENCENDIDO	283
18-5313-1	DISTRIBUIDOR	38, 209	18-5469	BOBINA ENCENDIDO ALTO RENDIMIENTO	33, 205, 283
18-5314	JUEGO DE CONTACTOS	31, 203, 281	18-5470	THUNDERBOLT IV V-8 DISTRIBUIDOR	37
18-5315-1	DISTRIBUIDOR	38, 209	18-5471	THUNDERBOLT IV V-6 DISTRIBUIDOR	37
18-5316-1	DISTRIBUIDOR	39, 209	18-5472	BOBINA ENCENDIDO ALTO RENDIMIENTO	33, 205, 283
18-5317	JUEGO DE CONTACTOS	31	18-5473	TAPA DISTRIBUIDOR	33, 204, 283
18-5318	JUEGO DE CONTACTOS	31	18-5474	TAPA DISTRIBUIDOR	33, 204, 283
18-5319	KIT DE PLATINOS	281	18-5475	DISTRIBUIDOR	37, 209, 284
18-5338	CONDENSADOR	31, 203, 281	18-5476	DISTRIBUIDOR	37, 208, 284
18-5339-1	DISTRIBUIDOR	39, 209, 281	18-5477	DISTRIBUIDOR ELECTRÓNICO	36, 207, 284
18-5342	CONDENSADOR	281	18-5478	DISTRIBUIDOR ELECTRÓNICO	36, 208, 285
18-5344	CONDENSADOR	32, 203	18-5479	DISTRIBUIDOR ELECTRÓNICO	36, 208, 285
18-5345	CONDENSADOR	32, 203, 281	18-5480	KIT DE CONVERSIÓN DE ENCENDIDO COMPLETO	36, 207, 284
18-5346	CONDENSADOR	32	18-5481	DISTRIBUIDOR ELECTRÓNICO ALTO RENDIMIENTO	36, 207
18-5347	CONDENSADOR	32, 203	18-5482	DISTRIBUIDOR ELECTRÓNICO ALTO RENDIMIENTO	36, 207
18-5348	CONDENSADOR	281	18-5483	DISTRIBUIDOR ELECTRÓNICO ALTO RENDIMIENTO	36, 207
18-5349	CONDENSADOR	281	18-5483	DISTRIBUIDOR ELECTRÓNICO ALTAS PREST.	284
18-5350	DISTRIBUIDOR	37	18-5484-1	DISTRIBUIDOR ELECTRÓNICO ROTACIÓN CONVENCIONAL	37, 209, 284
18-5351	DISTRIBUIDOR	37	18-5486-2	DISTRIBUIDOR ELECTRÓNICO	37, 208
18-5352	TAPA DISTRIBUIDOR	32, 204, 282	18-5487-2	DISTRIBUIDOR ELECTRÓNICO	38, 208
18-5353	TAPA DISTRIBUIDOR	32, 204, 282	18-5488	MODULO DE ENCENDIDO	34
18-5354	TAPA DISTRIBUIDOR	32, 204, 282	18-5489-2	DISTRIBUIDOR ELECTRÓNICO	38, 208
18-5356	TAPA DISTRIBUIDOR	282	18-5494-2	DISTRIBUIDOR ELECTRÓNICO	38, 208, 284
18-5357	TAPA DISTRIBUIDOR	282	18-5495-2	DISTRIBUIDOR ELECTRÓNICO	38, 208
18-5358	TAPA DISTRIBUIDOR	282	18-5496-2	DISTRIBUIDOR ELECTRÓNICO	38, 208
18-5361	TAPA DISTRIBUIDOR	32, 204, 282	18-5497-2	DISTRIBUIDOR ELECTRÓNICO	38
18-5362	TAPA DISTRIBUIDOR	32, 204, 282	18-5498-2	DISTRIBUIDOR ELECTRÓNICO	39, 209, 284
18-5369	TAPA DISTRIBUIDOR	32, 204, 282	18-5512	I/L DELCO EST KIT CONVERSIÓN	39
18-5375	TAPA DISTRIBUIDOR	204, 282	18-5513	V-6 DELCO EST KIT CONVERSIÓN	39
18-5376	TAPA DISTRIBUIDOR	33, 204	18-5514	V-8 DELCO EST KIT CONVERSIÓN	39
18-5384	TAPA DISTRIBUIDOR	33, 204	18-5518	I/L 4 SIERRA ELECTRÓNICO KIT CONVERSIÓN DISTRIBUIDOR	39
18-5385	TAPA DISTRIBUIDOR	33, 204	18-5519	I/L 6 SIERRA ELECTRÓNICO KIT CONVERSIÓN DISTRIBUIDOR	39
18-5386	TAPA DISTRIBUIDOR	33, 204	18-5520	V-8 KIT DISTRIBUIDOR CONVERSIÓN ELECTRÓNICA	39
18-5389	TAPA DISTRIBUIDOR	33	18-55419	ROTOR	204
18-5393	TAPA DISTRIBUIDOR	282, 283	18-55500	JUNTA CULATA	358
18-5394	TAPA DISTRIBUIDOR	282	18-55501	JUNTA CULATA	358
18-5395	TAPA DISTRIBUIDOR	33	18-55502	JUNTA CULATA	358
18-5396	TAPA DISTRIBUIDOR	33	18-55503	JUNTA CULATA	358
18-5397	TAPA DISTRIBUIDOR	33, 204	18-55510	MOTOR DE ARRANQUE	50
18-5399	JUNTA TAPA DISTRIBUIDOR	33, 247	18-55601	JUNTA CULATA	358
18-5399-9	JUNTA TAPA DISTRIBUIDOR	33, 247	18-55602	JUNTA CULATA	358
18-5402	ROTOR	32, 281	18-55603	JUNTA CULATA	358
18-5403	ROTOR	32, 203, 281	18-56000	JUNTA TAPA BONNET	358
18-5404-1	ROTOR	32, 203, 282	18-5603	ARRANQUE	51
18-5405	ROTOR	32, 203, 282	18-56481	KIT TAPONES BRONCE	365
18-5406	ROTOR	32, 203, 282	18-5657	TAPA BUJÍAS UNIVERSAL	288
18-5407	ROTOR	32, 203	18-56600	JUNTA CULATA	358
18-5408	ROTOR	32, 203, 282	18-56601	JUNTA TERMOSTATO	358
18-5411	ROTOR	204, 282	18-56602	JUNTA BOMBA AGUA	358
18-5413	ROTOR	204, 282	18-56870	TAPA DISTRIBUCIÓN	364
18-5418	ROTOR	32, 204	18-5700	RELÉ TRIM	297
18-5419	ROTOR	282	18-5704	RELÉ POWER TRIM	297
18-5420	ROTOR	32	18-5705	RELÉ POWER TRIM	217
18-5425	ROTOR	282	18-5705	RELÉ POWER TRIM	297
18-5428	ROTOR	282			
18-5431	ROTOR	32			

Código	Descripción	Páginas	Código	Descripción	Páginas
18-5711	REGULADOR VOLTAJE	217	18-5979	ALTERNADOR	294
18-5717	JUEGO ESCOBILLA	54	18-5983	ALTERNADOR	57
18-5717	JUEGO ESCOBILLAS	215	18-6021	TAPÓN ANODO	339
18-5740	REGULADOR DE VOLTAJE	58	18-6029 ZINC 603128 AL	ÁNODO	267
18-5745	BOBINA ENCENDIDO	283	18-6079 Mag 009369 Zinc 603040 AI	ÁNODO	189
18-5750 18-5750-9	TAPA BUJÍAS UNIVERSAL	50, 211, 288	18-6089 Mag 009372 Zinc 603044 AI	ÁNODO	189
18-5752	TAPA BUJÍAS UNIVERSAL	50, 211, 288	18-6099 Mag 025845 Zinc 603038 AI	ÁNODO	189
18-57702	FILTRO	322	18-61051	KIT TORNILLOS	34
18-57703	FILTRO AIRE	357	18-6114 Mag 009320 Zinc 603039 AI	ÁNODO	189
18-57704	FILTRO AIRE	357	18-6130	ANODO	339
18-5801	SOLENOIDE	54, 215	18-6131	ANODO	339
18-5802	SOLENOIDE	54, 215	18-6150 Mag 18-6150 Zinc 1603061 AI	KIT ÁNODO	189
18-5804	SOLENOIDE	54	18-6158M Mag 025532 Zinc 603062 AI	KIT ÁNODO	188
18-5806	SOLENOIDE ARRANQUE	296	18-6200	ANODO	358
18-5807	SOLENOIDE	215	18-6201	ANODO	358
18-5808	SOLENOIDE	215	18-6240Mag 025298 Zinc 603043 AI	ÁNODO	189
18-5810	SOLENOIDE	55	18-6241M Mag 009354 Zinc 603041 AI	ÁNODO	188
18-5811	SOLENOIDE MOTOR ARRANQUE	55, 215, 296	18-6253	PLATINA CONMUTADOR	56
18-5812	SOLENOIDE	215	18-6255	KIT ESCOBILLAS	56
18-5814	SOLENOIDE	215	18-6256	KIT MUELLE	56
18-5815	SOLENOIDE	55	18-6257	MOTOR TILT/TRIM	217
18-5816	SOLENOIDE	55	18-6260	ALTERNADOR	217
18-5817	SOLENOIDE	55	18-6261	ALTERNADOR	217
18-5820	SOLENOIDE	55	18-6261	ALTERNADOR	294
18-5836	SOLENOIDE	55	18-6265	ALTERNADOR	294
18-5837	SOLENOIDE	54, 215, 297	18-6266	RELÉ	297
18-5838	SOLENOIDE	54, 215	18-6268	RELÉ	297
18-5840	SOLENOIDE	54	18-6270	MOTOR DE ARRANQUE	213
18-5882	ALTERNADOR	294	18-6271	RELÉ	297
18-5888	MÓDULO DE ENCENDIDO	205	18-6274	MOTOR TILT/TRIM	298
18-5889	MÓDULO DE ENCENDIDO	205	18-6275	ARRANQUE	51
18-5890	MÓDULO DE ENCENDIDO	205	18-6275	MOTOR ARRANQUE	293
18-5894	INTERUPTOR PRESIÓN ACEITE	227, 305	18-6276	MOTOR DE ARRANQUE	213
18-5897	TRANSMISOR DE TEMPERATURA	94, 231, 305	18-6291	SOLENOIDE	215
18-5898	SENSOR TRANSMISOR DE TEMPERATURA	94, 231	18-6291	SOLENOIDE	296
18-5899	SENSOR PRESIÓN DE ACEITE	94, 231, 305	18-6293	ALTERNADOR	57
18-5903	ARRANQUE	53, 214, 293	18-6298	ALTERNADOR	57
18-5906	MOTOR ARRANQUE MANUFACTURADO	293	18-6350	KIT ENGRANAJES SUPERIOR	165
18-5907	ARRANQUE	51, 213	18-6351	KIT ENGRANAJES SUPERIOR	165
18-5908	ARRANQUE	52, 214	18-6351K	KIT REPARACIÓN UNIDAD INFERIOR	164
18-5910	ARRANQUE	52, 214	18-6352	KIT ENGRANAJES SUPERIOR	165
18-5911	MOTOR ARRANQUE	51, 213, 293	18-6352K	KIT REPARACIÓN UNIDAD SUPERIOR	164
18-5913	ARRANQUE	52, 214, 293	18-6353	KIT ENGRANAJES SUPERIOR	165
18-5917	MOTOR DE ARRANQUE	214	18-6353K	KIT REPARACIÓN UNIDAD INFERIOR	164
18-5919	ARRANQUE	52, 213, 293	18-6399	ACOPLAMIENTO EJE	255
18-5920	ARRANQUE	51, 213, 293	18-6400	EJE CARDAN TRASERO	166
18-5923	ARRANQUE, PMGR, FORD	213	18-6401	CARDAN COMPLETO	167
18-5927	ARRANQUE, PMGR, FORD	213, 293	18-6404	ALOJAMIENTO CRUCETA	166
18-5939	ALTERNADOR	295	18-6406	KIT CRUCETA CARDAN	167
18-5943	ALTERNADOR	295	18-6406	CRUCETA	334
18-5945	ALTERNADOR	57	18-6523	KIT MUELLES	334
18-5946	ALTERNADOR	57	18-6746	MOTOR TILT/TRIM	56
18-5949	KIT CONVERSIÓN CORREA	58	18-6747	TILT/TRIM	55
18-5953-1	KIT CONVERSIÓN ALTERNADOR	58	18-6748	SOPORTE TRIM	55
18-5956	ALTERNADOR	57			
18-5957	ALTERNADOR	57, 217, 294			
18-5959	ALTERNADOR	295			
18-5960	ALTERNADOR	57			
18-5965	ALTERNADOR	57			
18-5966	ALTERNADOR	57			
18-5967	ALTERNADOR	57			
18-5968	SOPORTE ALTERNADOR	58			
18-59700	ALTERNADOR	294			
18-59710	ALTERNADOR	294			
18-5976	ALTERNADOR	295			

Código	Descripción	Páginas	Código	Descripción	Páginas
18-6750	SOPORTE TRIM	55	18-6949	ARRANQUE	53
18-6752	BOMBA HIDRÁULICA TRIM	55	18-6950	FUSIBLE POWER TRIM	218
18-6753	BOMBA HIDRÁULICA TRIM	55	18-6951	FUSIBLE POWER TILT	297
18-6754	MOTOR TILT	217	18-6951-9		
18-6755	MOTOR TILT	217	18-6953	ALTERNADOR	295
18-6758	MOTOR TILT/TRIM	298	18-6953	ALTERNADOR	341
18-6763	MOTOR TILT/TRIM	56	18-6955	ALTERNADOR	295
18-6764	MOTOR TILT/TRIM	218	18-6955	ALTERNADOR	341
18-6768	BOMBA POWER TRIM	56	18-69550	DISYUNTOR	297
18-6769-1	BOMBA TILT/TRIM	56	18-6956	MOTOR ARRANQUE	294
18-6770	BOMBA TILT/TRIM	297	18-6957	ARRANQUE	53
18-6771	DEPÓSITO TILT/TRIM	56	18-6958	MOTOR ARRANQUE	294
18-6772	BOMBA MOTOR TILT	56	18-6960	ALTERNADOR	58
18-6778	TILT/TRIM DEPÓSITO	56	18-6970	ALTERNADOR	352
18-6779	MOTOR TRIM	218	18-6971	ALTERNADOR	352
18-6779	MOTOR TRIM	298	18-6975	ALTERNADOR	57
18-6790	MOTOR TILT	298	18-6975	ALTERNADOR	295
18-6791	MOTOR TILT	298	18-6999	SOPORTE PARA FILTRO	80
18-6792	MOTOR TILT	298	18-7000	KIT CARBURADOR	299
18-6799	KIT BOMBA POWER TRIM	56	18-7001	KIT CARBURADOR	299
18-6804	MOTOR TRIM	297	18-70021	MANGUITO	98
18-6806	BOMBA TRIM	297	18-70021	MANGUITO	232
18-6813	MOTOR TRIM	56	18-70021	MANGUITO	309
18-6814	MOTOR TRIM	218	18-7008	KIT CARBURADOR	299
18-6817	MOTOR TRIM	297	18-7017	KIT CARBURADOR	220
18-6822	BOMBA TRIM	297	18-7018	KIT CARBURADOR	220
18-6823	CABLEADO	56	18-7040	KIT CARBURADOR	299
18-6823	CABLEADO	218	18-7070	KIT CARB	69
18-6823	CABLEADO	298	18-7070	KIT CARBURADOR	220
18-6834	MOTOR ARRANQUE	293	18-70704	MANGUITO	98
18-6835	MOTOR ARRANQUE	294	18-70704	MANGUITO	232
18-6838	TRIM MOTOR	298	18-70704	MANGUITO	309
18-6839	MOTOR ARRANQUE	294	18-7071	KIT CARB	69
18-6841	ALTERNADOR	57	18-7071	KIT CARBURADOR	220
18-6841	ALTERNADOR	217	18-7072	KIT CARB	70
18-6842	ALTERNADOR	57	18-7072	KIT CARBURADOR	220
18-6844	ALTERNADOR	57	18-7072	KIT CARBURADOR	299
18-6845	ALTERNADOR	295	18-7075	KIT CARB	69
18-6846	ALTERNADOR	295	18-7076	KIT CARB	70
18-6846	ALTERNADOR	341	18-7077	KIT CARB	70
18-6847	ALTERNADOR	295	18-7078	KIT CARB	70
18-6848	ALTERNADOR	295	18-7080	KIT CARB	70
18-6849	ALTERNADOR	352	18-7080	KIT CARBURADOR	220
18-6870	ARRANQUE	53	18-7081	KIT CARB	70
18-6872	MOTOR ARRANQUE	294	18-7081	KIT CARBURADOR	220
18-6872	ARRANQUE	341	18-7085	KIT CARBURADOR	299
18-6880	ARRANQUE	352	18-7086	KIT CARBURADOR	220, 299
18-6881	MOTOR CON BOBINA TRIM	298	18-70924	MANGUITO	98, 232, 309
18-6925	ALTERNADOR	352	18-70925	MANGUITO	97
18-6926	ALTERNADOR	352	18-70926	MANGUITO	97
18-6927	ALTERNADOR	352	18-70927	MANGUITO	97
18-6928	ALTERNADOR	352	18-70928	MANGUITO	97
18-6929	ALTERNADOR	352	18-70929	MANGUITO	97
18-6930	ARRANQUE	352	18-70930	MANGUITO	98
18-6931	ARRANQUE	352	18-70931	MANGUITO	98
18-6932	ARRANQUE	352	18-70932	MANGUITO	98
18-6934	ARRANQUE	352	18-70933	MANGUITO	96
18-6935	ARRANQUE	352	18-70934	MANGUITO	96
18-6936	ARRANQUE	353	18-70935	MANGUITO	96
18-6937	ARRANQUE	353	18-70938	MANGUITO	96
18-6938	ARRANQUE	353	18-70939	MANGUITO	96
18-6939	ARRANQUE	352	18-70940	MANGUITO	96
18-6944	ARRANQUE	341	18-70943	MANGUITO	97
18-6946	ARRANQUE	53	18-70945	MANGUITO	95
18-6947	ARRANQUE	53	18-70946	MANGUITO	96
18-6948	ALTERNADOR	58			

Código	Descripción	Páginas	Código	Descripción	Páginas
18-70947	MANGUITO	95	18-7331	BOMBA ELÉCTRICA DE COMBUSTIBLE	224
18-70948	MANGUITO	95	18-7331	BOMBA COMBUSTIBLE ELÉCTRICO	301
18-70949	MANGUITO	95	18-7370N	CARBURADOR	65
18-7095	KIT CARBURADOR	70, 220, 299	18-7373N	MERCARB 2V CARBURADOR	65
18-70951	MANGUITO	95	18-7375N	CARBURADOR	65
18-70952	MANGUITO	95	18-7376N	CARBURADOR	65
18-70953	MANGUITO	95	18-7489	CARBURADOR WEBER 750	362
18-70954	MANGUITO	95	18-7492	BOBINA	283
18-70955	MANGUITO	95	18-7493	BOBINA	34
18-70956	MANGUITO	95	18-7493	BOBINA	283
18-70958	MANGUITO	96	18-7508	BOMBA DIRECCIÓN	130
18-7096	KIT CARB	70	18-75100	MANGUITO	98, 232, 309
18-7096	KIT CARBURADOR	221	18-75125	MANGUITO	98, 232, 309
18-7097	KIT CARB	70	18-7513	SENSOR DE TEMPERATURA	305
18-7098-1	KIT CARB	70	18-7514	BOMBA DIRECCIÓN	322
18-7099	KIT JUNTA CARBURADOR	300	18-7550	SENSOR DE PICADO	61
18-71218	MANGUITO	98, 232, 309	18-7551	SENSOR MAP	62
18-71337	MANGUITO	98, 232, 309	18-7553	SENSOR DE GOLPE	62
18-7200	FLOTADOR	71, 222, 300	18-7554	SENSOR DE GOLPE	62
18-72005	KIT TUERCAS Y ARANDELAS	182	18-7556	CIGÜEÑAL SENSOR	34
18-7201	FLOTADOR	71, 222, 300	18-7600	SENSOR DE TEMPERATURA	61
18-7202	FLOTADOR	71, 300	18-7601	SENSOR DE TEMPERATURA	218, 305
18-7206	FLOTADOR NITROPHILO	222	18-7603-1	CARBURADOR	65
18-7227	TERMOSTATO STARTER	71	18-7604-1	CARBURADOR	65
18-7228	ANTI-DEFLAGRANTE	74	18-7605-1	CARBURADOR	65
18-7229	ANTI-DEFLAGRANTE	74, 223, 301	18-7605-1	CARBURADOR	219
18-7230	ANTI-DEFLAGRANTE	74	18-7608-1	CARBURADOR	65
18-7231	ANTI-DEFLAGRANTE	74	18-7608-1	CARBURADOR	219
18-7232	ANTI-DEFLAGRANTE	74	18-7609-1	CARBURADOR	65
18-7234	ANTI-DEFLAGRANTE	74	18-7609-1	CARBURADOR	219
18-7235	KIT CARBURADOR	221	18-7610-1	CARBURADOR	65
18-7236	KIT CARBURADOR	221	18-7611-2	CARBURADOR	65
18-7237	KIT CARBURADOR	221, 299	18-7613-1	CARBURADOR	65
18-7238	KIT CARBURADOR	221, 299	18-7615-1	CARBURADOR	65
18-7239	KIT CARBURADOR	221	18-7615-1	CARBURADOR	219
18-7241	KIT CARBURADOR	221, 299	18-7615N	CARBURADOR Q-JET	65, 219
18-7242	KIT CARBURADOR	221, 299	18-7616-1	CARBURADOR	65
18-7243	KIT CARBURADOR	221	18-7617-1	CARBURADOR	65
18-7244	KIT CARBURADOR	221, 300	18-7618-1	CARBURADOR	66
18-7245	KIT CARBURADOR	221, 300	18-7619-1	CARBURADOR	66
18-7246	KIT CARBURADOR	221, 300	18-7627	COLECTOR ADMISIÓN	362
18-72510	KIT TORNILLO	182	18-7628	COLECTOR ADMISIÓN	362
18-7256	BOMBA COMB	75, 223	18-7630	SENSOR POSICIÓN ACELERADOR	61
18-7258	BOMBA COMBUSTIBLE	223	18-7632	CONTROL MOTOR RELANTI	61
18-7265	BOMBA COMBUSTIBLE	223	18-7633	KIT EMISOR TRIM	186
18-7266	BOMBA COMB	75	18-7634	TRANSMISOR TRIM	267
18-7267	BOMBA COMB	75, 223	18-7635	CARBURADOR (REMANUFACTURADO)	219
18-7268	BOMBA COMBUSTIBLE	301	18-7636	CARBURADOR (REMANUFACTURADO)	219
18-7274	BOMBA COMB	75	18-7637	CARBURADOR (REMANUFACTURADO)	219
18-7275	BOMBA COMB	75	18-7638	CARBURADOR (REMANUFACTURADO)	219
18-7278	BOMBA COMB	75, 223	18-7639	CARBURADOR	65
18-7281	BOMBA COMBUSTIBLE	301	18-7640	CARBURADOR	65
18-7282	BOMBA COMB	75	18-7640	CARBURADOR (REMANUFACTURADO)	219
18-7283	BOMBA COMB	75	18-7641	CARBURADOR	298
18-7284	BOMBA COMB	75	18-7642	ENS. PICK-UP	34
18-7286	BOMBA COMBUSTIBLE	301	18-7642	SENSOR DELCO	283
18-7288-1	BOMBA COMB	75	18-7643	SENSOR CIGÜEÑAL	283
18-7289	BOMBA COMBUSTIBLE	223	18-7646	SENSOR ARBOL DE LEVAS	62
18-73131	PIVOTE	168	18-7647	TRANSMISOR DE TEMPERATURA	305
18-7321	ABRAZADERA FUELLE	172	18-7648	BOBINA ENCENDIDO	34
18-7321-9			18-7648	BOBINA ENCENDIDO	283
18-7326	BOMBA COMBUSTIBLE ELÉCTRICO	75	18-7660	SENSOR DE PICADO	61
18-7326	BOMBA ELÉCTRICA DE COMBUSTIBLE	224	18-7663	REGULADOR DE PRESIÓN COMBUSTIBLE	61
18-7326	BOMBA COMBUSTIBLE ELÉCTRICO	301	18-7664	TERMOSTATO STARTER	71
18-7330	BOMBA ELÉCTRICA DE COMBUSTIBLE	224	18-7665	TERMOSTATO STARTER	71
18-7330	BOMBA COMBUSTIBLE ELÉCTRICO	301	18-7666	INTERRUPTOR PRESIÓN	71

Código	Descripción	Páginas	Código	Descripción	Páginas
18-7667	TERMOSTATO STARTER	71	18-7917	DIESEL FILTRO ACEITE	359
18-7668	MAP SENSOR	62	18-7919	FILTRO SEPARADOR GASOLINA AGUA	81
18-7677	SENSOR DE GOLPE	62	18-7925	DIESEL FILTRO ACEITE	359
18-7677	SENSOR DE GOLPE	218	18-7926	DIESEL FILTRO ACEITE	359
18-7677	SENSOR DE GOLPE	305	18-7927	DIESEL FILTRO ACEITE	359
18-7679	SENSOR DE GOLPE	218	18-7931	DIESEL FILTRO COMBUSTIBLE	357
18-7679	SENSOR DE GOLPE	305	18-7934	DIESEL FILTRO COMBUSTIBLE	357
18-7682	SENSOR DE PICADO	61	18-7935	DIESEL FILTRO COMBUSTIBLE	357
18-7683	REGULADOR DE PRESIÓN COMBUSTIBLE	61	18-7942	FILTRO COMBUSTIBLE	304, 344
18-7684	SENSOR DE PICADO	61, 218, 305	18-7962	CULATA	323
18-7685	INYECTOR TBI	62, 305	18-7964	FILTRO KIT TRANSMISIÓN	81, 227, 305
18-7688	INYECTOR COMBUSTIBLE	62	18-7965-1	10 MICRON COMPACTO KIT SEPARADOR	80, 303
18-7689	INYECTOR COMBUSTIBLE	218	18-7970	DIESEL FILTRO COMBUSTIBLE 20 MICRONES	357
18-7689	COMBUSTIBLE INYECTOR	305	18-7974	FILTRO ACEITE	323
18-7690	KIT RETÉN INYECTOR	63	18-7977	"GEN III SISTEMA DE FILTRO COMB. REFRIGERACIÓN COMB."	81
18-7691	KIT RETÉN INYECTOR	63	18-799001	VST FILTRO	81
18-7692	KIT RETÉN INYECTOR	63	18-79960	ELEMENTO FILTRO COMBUSTIBLE	357
18-7693	KIT RETÉN INYECTOR	63	18-79994N	CARBURADOR	66
18-7694	KIT RETÉN INYECTOR	63	18-79995N	CARBURADOR	66
18-7695	KIT RETÉN INYECTOR	63	18-79996	CARBURADOR	66
18-7696	KIT RETÉN INYECTOR	63	18-79997	CARBURADOR	66
18-7697	IAC MOTOR	61	18-79998	CARBURADOR	298
18-7698	INYECTOR COMBUSTIBLE	62	18-80005	CARBURADOR	298
18-7700	SENSOR POSICIÓN ACELERADOR	61, 305	18-80006	CARBURADOR (REMANUFACTURADO)	219
18-7701	CONTROL MOTOR	61	18-80008	CARBURADOR (REMANUFACTURADO)	219, 298
18-7702	SENSOR DE TEMPERATURA	94, 305	18-80009	CARBURADOR (REMANUFACTURADO)	219, 298
18-7703	SENSOR DE GOLPE	62, 218, 305	188002S	BOMBA DE SUCCIÓN	370
18-7704	IAC MOTOR	305	188005S	BOMBA DE SUCCIÓN	370
18-7705	IAC MOTOR	305	188017S	LINEA DE COMBUSTIBLE OMC	370
18-7706	SENSOR POSICIÓN CIGÜEÑAL	283	1880408		
18-7709	FILTRO COMBUSTIBLE	304	1880403	CONECTOR DE COMBUSTIBLE	375
18-7715	FILTRO COMBUSTIBLE	81	188068		
18-7717	FILTRO ELEMENTO	81, 227, 305	188082	CONECTOR DEPÓSITO	375
18-7721	FILTRO COMBUSTIBLE	81	18-8072	CODO DEPÓSITO	227
18-7726	KIT CARBURADOR	221	18-8074		
18-7727	KIT CARBURADOR	221	18-8055	RACOR	227
18-7728	KIT CARB	70	18-8114	LINEA DE COMBUSTIBLE	69, 223, 300
18-7730	KIT CARBURADOR	221	18-8115	LINEA DE COMBUSTIBLE	69, 223, 300
18-7746	KIT CARB	70	18-8124	FILTRO COMBUSTIBLE	304
18-7748	KIT CARB	70	18-8124	DIESEL FILTRO COMBUSTIBLE	344
18-7749	KIT CARB	70	18-8125	FILTRO COMBUSTIBLE DIESEL	304, 344
18-7751	KIT CARB	69	18-8126	FILTRO COMBUSTIBLE DIESEL	304, 344
18-7757	SENSOR POSICIÓN ACELERADOR	62, 283	18-8149	FILTRO SEPARADOR AGUA/COMB. DE ALTA CAPACIDAD	304
18-7774	SOPORTE ALUMINIO PARA CONTACTO	80, 303	18-8205	KIT RETENES TRANSOM	170
18-7778	SOPORTE ALUMINIO	303	18-8206-1	KIT RETENES TRANSOM	170
18-7784	FILTRO COMBUSTIBLE	81	18-8208	KIT RETENES Y COJINETES	191
18-7792	FILTRO COMBUSTIBLE	226, 304	18-8212-1	KIT RETENES TRANSOM	170
18-7854	FILTRO COMBUSTIBLE	226	18-8213	KIT RETENES TRANSOM	170
18-7855	FILTRO COMBUSTIBLE	81, 226	18-8216	CONECTOR	125, 238
18-7858	FILTRO COMBUSTIBLE	81, 227, 304	18-8217	KIT RETENES TRANSOM	170
18-7859	FILTRO COMBUSTIBLE	81, 227, 304	18-8218	KIT RETENES TRANSOM	170
18-7860	FILTRO COMBUSTIBLE	81, 227	18-8219	KIT RETENES TRANSOM	170
18-7861	RECAMBIO DE CESTO Y FILTRO	227	18-8220	KIT FUSIBLE	58
18-7862	RECAMBIO	227	18-8227	POLEA BOMBA CON DIRECCIÓN ASISTIDA	130
18-7862	ELEMENTO FILTRANTE COMBUSTIBLE	304	18-8297	POLEA BOMBA DIRECCIÓN	130
18-7869	FILTRO COMBUSTIBLE	81	18-8311	KIT DE RECONSTRUCCIÓN TRANSOM	167
18-7873	FILTRO COMBUSTIBLE	81	18-8312	KIT DE RECONSTRUCCIÓN TRANSOM	167
18-7880	DIESEL FILTRO ACEITE	345	18-8313	KIT DE RECONSTRUCCIÓN TRANSOM	167
18-7884	DIESEL FILTRO ACEITE	345	18-8357	KIT DE RETENES COMPLETO	340
18-7886	DIESEL FILTRO ACEITE	359	18-8358	KIT RETÉN UNIDAD INFERIOR	340
18-7888	REC. TAPÓN Y JUNTA DRENAJE	306	18-8359	KIT RETENES ENGRANAJE SUPERIOR	340
18-7890	FILTRO AIRE	322	18-8361	KIT RETÉN SUPERIOR	340
18-79007	FILTRO DE AIRE	305	18-8368	ARO DE GOMA	334
18-7907	FILTRO AIRE	322	18-8369	INDICADOR ACEITE CON ARANDELA	251
18-7908	FILTRO AIRE	322	18-8370	KIT REACONDICIONAMIENTO COMPLETO CAJA ENGRANAJES	191
18-7910-1	DIESEL FILTRO ACEITE	359			

Código	Descripción	Páginas	Código	Descripción	Páginas
18-8412	EXTENSIÓN TORNILLO ARRANQUE	53	603080 AL 009376 Zinc	ANODO	336
18-8412	EXTENSOR DE ESPÁRRAGO DE ARRANQUE	215	603081 AL 18-6104 Mag 009347 Zinc	ANODO	336
18-8500	KIT DE MONTAJE CODO DE ESCAPE	122	603082 AL 18-6105 Mag 009346 Zinc	ANODO	336
18-8502	KIT DE MONTAJE	239, 314	603084 AL 009350 Zinc	ANODO	336
18-8505	KIT DE MONTAJE CODO DE ESCAPE	122	603086 AL 18-6106 Mag 009352 Zinc	ANODO	336
18-8507	KIT DE MONTAJE	239, 314	603087 AL 18-6125 Mag 025492 Zinc	PLATINA TRANSOM	336
18-8508	KIT DE MONTAJE CODO DE ESCAPE	122	603090 AL 009351 Zinc	ANODO	336
18-8510	KIT MONTAJE CODO ESCAPE	316	603091 AL 18-6102 Mag 025840 Zinc	ANODO	336
18-8511	KIT MONTAJE COLECTOR ESCAPE	316	603096 AI	ÁNODO ALUMINIO	189
18-8512	KIT DE MONTAJE CODO DE ESCAPE	122	603097 AL	KIT COMPLETO VOLVO	338
18-8514	KIT DE MONTAJE CODO DE ESCAPE	122	603098 AL	KIT COMPLETO VOLVO	338
18-8520	KIT DE MONTAJE CODO DE ESCAPE	122	603099 AL	KIT COMPLETO VOLVO	338
18-8529	KIT DE MONTAJE CODO DE ESCAPE	123	603100 AL	KIT COMPLETO VOLVO	338
18-8530	KIT DE MONTAJE CODO DE ESCAPE	123	603101 AL	KIT COMPLETO VOLVO	339
18-8531	KIT DE MONTAJE CODO DE ESCAPE	123	603105 AL	KIT COMPLETO VOLVO	339
18-8532	KIT DE MONTAJE CODO DE ESCAPE	123	603107 AL	KIT TORNILLERIA	339
18-8533	KIT DE MONTAJE COLECTOR DE ESCAPE	123	603109 AL	KIT TORNILLERIA	339
18-8534	KIT DE MONTAJE	239	603110 AL	KIT TORNILLERIA	339
18-8535	KIT DE MONTAJE	123, 239, 316	603111 AL	KIT TORNILLERIA	339
18-8536	KIT DE MONTAJE CODO DE ESCAPE	123, 239, 316	603157 AI	KIT ÁNODO ALUMINIO BRAVO 3	189
18-8538	KIT DE MONTAJE COLECTOR DE ESCAPE	123, 239, 316	603162 AI	ÁNODO ALUMINIO BRAVO 3	189
18-8539	KIT MONTAJE COLECTOR ESCAPE	316	603206 AL 009398 Zinc	ANODO	336
18-8553	KIT DE MONTAJE	239	603207 AL 18-6127 Mag VOL3589745 Zinc	ANODO TRANSOM	336
18-8554	KIT DE MONTAJE CODO DE ESCAPE	123	603208 AL 18-6126 Mag 009394 Zinc	ANODO TRANSOM	336
18-8555	KIT DE MONTAJE CODO DE ESCAPE	123	MP28880	HOMBRE AL AGUA	211
18-8556	KIT DE MONTAJE CODO DE ESCAPE	123	MP28890	HOMBRE AL AGUA	211
18-8701	CULATA	323	P21325765	ABRAZADERA ESCAPE	314
18-8702	CULATA	323	P3884701	CODO VOLVO	314
18-8860	BOMBA COMB	75	P845261	CODO ESCAPE	313
18-8861	BOMBA COMBUSTIBLE CON REFRIGERACIÓN	74	P8591289	CODO VOLVO	314
18-8862	BOMBA COMBUSTIBLE CON REFRIGERACIÓN	74	P859963	CODO VOLVO	314
18-8864	BOMBA COMBUSTIBLE CON REGULADOR	74			
18-8865	BOMBA COMBUSTIBLE	74			
18-8867	BOMBA COMBUSTIBLE	74			
18-8868	BOMBA COMBUSTIBLE	75			
18-8950	IMPULSOR	357			
18-8951	IMPULSOR	357			
18-8952	IMPULSOR	357			
18-8955	TAPA DEL SEPARADOR	81			
18-8962	CONJUNTO TAPA VÁLVULA	365			
18-8963	CONJUNTO TAPA VÁLVULA	365			
18-8964	POLEA BOMBA DIRECCIÓN	321			
18-9010	TOMA AGUA REFORZADA	185			
18-9096	BLOQUEADOR COLAS	333			
18-9098	BLOQUEADOR COLA	265, 333			
18-9099	BLOQUEADOR DE COLAS	185			
18-9218	CARDAN COMPLETO	167			
18-9240-0 18-9240-1	GRASA MARINA	175			
18-9802	LUZ CRONOMETRAJE	55, 218, 297			
18-9803	LLAVE PARA COJINETES	175			
18-9806E	VASO CABLE CAMBIO	172			
18-9876	HERAMIENTA DE CALIBRACIÓN	254			
603045 AI 18-6117M Mag 025424 Zinc	ÁNODO	188			
603048 AI 009464 Zinc	ÁNODO	189			
603050 AI	ÁNODO ALUMINIO	189			
603063 AI 18-6159 M Mag 025531 Zinc	KIT ÁNODO	188			
603064 AI 18-6160 Mag 18-6160 Zinc	KIT ÁNODO	188			
603065 AI 18-6154 Mag 025534 Zinc	KIT ÁNODO	188			

INSTALACIONES



Central GAVA:
Miquel Servet 19,
"Polígono Industrial Camí Ral"
08850 Gavà. - BARCELONA
T. 936 333 680 - F. 936 625 733
info@pronautic.net

Horario:
Todo el año: de 9h. a 18h.



Delegación GIRONA:
La Selva 19, "Pol Industrial El Pla"
17486 Castello d'Empuries - GIRONA
T. 972 749 059
girona@pronautic.net

Horario:
Abril a septiembre: de 9h. a 13h y 14h. a 19h
Resto del año: de 9h. a 13h y 14h. a 18h

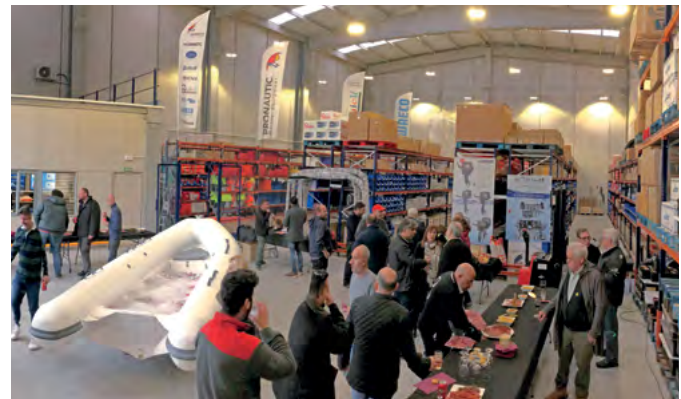

Delegación PALMA MALLORCA:
Gremi Corredors 22
Centre Tramuntana Nave 7 Pol. Ind.
07009 Palma de Mallorca - Son Rossinyol
T. 871 004 828
mallorca@pronautic.net

Horario:
Todo el año: de 8h. a 17h.





PRONAUTIC
MARINE EQUIPMENT

www.pronautic.net

Central GAVA:

Miquel Servet 19,
Polígono Industrial Camí Ral
08850 Gavà. - BARCELONA
T. 936 333 680 - F. 936 625 733
info@pronautic.net

Contactos Gava:

Pedidos / Comercial:
ventas@pronautic.net

Contabilidad / Administración:

T. 936 629 208
administracion@pronautic.net

Compras:

T. 936 333 681
compras@pronautic.net

Recambios:

T. 936 333 681 Ext.: 3215
albert@pronautic.net

Delegación GIRONA:

La Selva 19
Pol Industrial El Pla
17486 Castello d'Empuries - GIRONA
T. 972 749 059
girona@pronautic.net

Delegación PALMA DE MALLORCA:

Gremi Corredors 22
Centre Tramuntana Nave 7 Pol. Ind.
07009 Palma de Mallorca - Son Rossinyol
T. 871 004 828
mallorca@pronautic.net